

**APPENDIX J
WATER QUALITY TECHNICAL SUPPORT DOCUMENT**



ADDENDUM – WATER QUALITY

RESPONSE LETTER TO COMMENTS ON THE IAMGOLD CÔTÉ GOLD PROJECT ENVIRONMENTAL IMPACT STATEMENT (EIS)/DRAFT ENVIRONMENTAL ASSESSMENT (EA) REPORT TECHNICAL SUPPORT DOCUMENT : WATER QUALITY

1.0 INTRODUCTION

This addendum to Appendix J - Water Quality Technical Support Document (TSD) has been prepared to address comments received from the Aboriginal groups, government reviewers and interested stakeholders on the Environmental Impact Statement (EIS)/Draft Environmental Assessment (EA) Report.

Comments submitted to IAMGOLD have been provided and responded to in Appendix Z of the Amended EIS/Final EA Report. Minor editorial comments related to the TSD have been directly addressed through updates in the TSD, and these changes are tracked in Appendix Z. Comments that request additional information to support the TSD have been addressed through this addendum to the Water Quality TSD. Comments which require more information or greater clarification are generally focused on the following technical areas:

- Interpretation of Baseline Data;
- Total Phosphorus Predictions;
- Total Suspended Solids Predictions;
- Tailings Geochemistry and Process Water Quality;
- Seepage Loading Rates;
- Comparison Criteria for Predicted Free Cyanide Concentrations; and
- Application of Mine Rock Humidity Cell Test Data.

2.0 INTERPRETATION OF BASELINE DATA

In this section, discussions and data are provided to supplement the responses to Comments #188, 192, 198, 203, 204, 207, 211, 214 and 692, which are related to:

- 1) the presentation of baseline data (statistical analyses and assessment of seasonal and temporal trends, evaluation of quality assurance/quality control samples);
- 2) water quality comparisons of lakes and watercourses that will be affected by the proposed realignments; and



3) the application of the 95th percentile baseline concentrations.

Further information is provided in the sections below.

2.1 Presentation of Baseline Data

The baseline water quality summary presented in Appendix J was intended to provide an overview of the existing conditions results in order to assess the potential Project effects on water quality as a whole. The baseline data for each lake was presented in Appendix J, Attachment I, Appendix A, with parameter concentrations screened against Provincial Water Quality Objectives (PWQO), Canadian Water Quality Guidelines (CWQG), and Ontario Drinking Water Standards (ODWS). Baseline water quality sampling has been ongoing since the baseline summary was issued in 2013 and, as such, a larger, updated dataset was available for analysis in response to reviewer comments. Although the approach of the effects assessment is to evaluate changes in overall water quality due to the Project, and not to necessarily conduct effects assessments on individual lakes, statistical calculations have been performed on the updated dataset and are provided in Tables 1a through 3a. To assess spatial patterns, the average concentrations and one standard deviation in lakes across the Mollie River and Mesomikenda Lake Watersheds were plotted on Figures 1a to 2a. To assess seasonal patterns, the monthly average concentrations of selected parameters across the Mollie River and Mesomikenda Lake Watersheds were plotted on Figure 3a. The average baseline levels do not differ by much; as such, the influence of minor seasonal variations within individual lakes and minor spatial variations within each watershed are not central to evaluating the effects, and therefore do not change the conclusion of the impact assessment.

As part of a quality assurance/quality control review, the analytical data for blind duplicate samples were reviewed. In order to provide a quantitative measure of the precision of duplicate analysis, the relative percent difference (RPD) was calculated. Samples with an RPD of greater than 30% were identified and tabulated, recognizing that it is not uncommon to have high RPDs when concentrations are near the method detection limit (MDL). To satisfy reviewer comments, samples with an RPD of greater than 20% are identified and tabulated in Table 4a. The parameter concentrations in the blank samples were compared to the MDL and the concentrations of the following parameters were greater than 5 times the MDL in the 17 surface water blanks collected between November 2011 and March 2013: calcium in 3 samples, sodium in 11 samples, aluminum in 3 samples, molybdenum in 1 sample and zinc in 2 samples. As concentrations approach the MDL, the analysis sensitivity degrades and there is greater potential for outliers in the dataset. In the analysis of the baseline dataset and use in the effects predictions, suspect laboratory results were flagged, identified to the analytical laboratory and not included in the calculations to derive inputs for the water quality model. Therefore, the reassessment of the RPD of duplicate sets and the comparison of field blanks to MDLs does not materially change the effect predictions.

Although not summarized in the summary Table 1 in Appendix J, Attachment I, the surface water quality analytical data and sampling dates are provided in Appendix J, Attachment I, Appendix A. In response to a reviewer comment, Table 5a has been created to present the specific sampling dates and number of sampling events.

2.2 Water Quality Comparisons with respect to Watercourse Realignments

As part of the proposed development of the open pit, Côté Lake will be drained and portions of Three Duck Lakes, Clam Lake, Bagsverd Creek and the Mollie River system will be dammed and/or require realignment.

The water quality of the lakes and watercourses to be realigned, and to receive input flow from the realignments, are compared in Table 6a; a summary of these comparisons is provided below.

As detailed in Chapter 5 – Project Description, Section 5.10.7.1, the drainage of Côté Lake will require the construction of multiple dams to isolate it from connected water bodies. Côté Lake will be dewatered following the completion of these dams. Côté Lake is currently draining to Three Duck Lakes and will drain to Three Duck Lakes in the early stages of construction.

As detailed in Chapter 5 – Project Description, Section 5.10.7.2, Chester Lake currently feeds into the Mollie River, but the realignment will have the outflow of Chester Lake directed to Clam Lake. The average baseline concentrations from the updated Chester Lake and Clam Lake datasets are very similar; as such, the input from Chester Lake is not expected to materially change the water quality in Clam Lake.

As detailed in Chapter 5 – Project Description, Section 5.10.7.3, Clam Lake and Little Clam Lake currently flow into the proposed open pit, but the realignment will have the outflow diverted into the West Beaver Pond and the south end of Bagsverd Creek. The average baseline concentrations from the updated Little Clam Lake and West Beaver Pond (P-6) datasets are very similar; as such, the input from Little Clam Lake is not expected to materially change the water quality in the West Beaver Pond.

As detailed in Chapter 5 – Project Description, Section 5.10.7.4, Three Duck Lakes will no longer receive flow from Côté Lake. In order to maintain water flow through the Mollie River watershed, channels will be constructed to connect Bagsverd Lake (South) to Weeduck Lake and Weeduck Lake to Upper Three Duck Lakes. The average baseline concentrations from the updated Bagsverd Lake and Weeduck Lake datasets are very similar; as such, the input from Little Clam Lake is not expected to materially change the water quality in the West Beaver Pond.

As detailed in Chapter 5 – Project Description, Section 5.10.7.5, Bagsverd Creek will be realigned in order to maintain the connection between Bagsverd Lake and downstream reaches of Bagsverd Creek following the construction of the TMF. The realignment will be constructed between Bagsverd Lake and Unnamed Lake #2. The average baseline concentrations from the updated Bagsverd Lake and Unnamed Lake #2 datasets are very similar, with the exception of average iron concentrations, which are an order of magnitude higher in Unnamed Lake #2 than Bagsverd Lake. The iron concentration in Unnamed Lake #2 is expected to decrease with the addition of flow from Bagsverd Lake, and the input from Bagsverd Lake is not expected to materially change the concentrations of other parameters in Unnamed Lake #2.

In summary, the draining Côté Lake to Three Duck Lakes in the early stages of construction will not negatively affect the water quality in Three Duck Lakes. Similarly, the realignments will establish connection of water bodies that have similar water quality and significant impacts to receiver water quality are therefore not predicted.

2.3 Application of 95th Percentile Baseline Concentrations

A set of 95th percentile baseline concentrations were derived for the following purposes:

- to assist with the water quality effects assessment, in particular to assist with providing a basis for the magnitude aspect of the impact assessment; and
- to provide results to the Aquatic Biology team that compare the predicted water quality results in the surface water receivers to Aquatic Health Benchmarks derived using the most recent of the PWQO or CWQG, or

the upper limit of background (95th percentile baseline concentration), whichever is higher for each parameter.

Statistical procedures that have been used to define the upper limit of background include the upper 95% confidence limit, and the 90th or 95th percentile, among others (BCMELP 1997; Hill et al. 2006; Roe et al. 2006). The approach of using the 95th percentile concentrations to define the upper limit of background concentrations is consistent with the CCME background concentration procedure (CCME 2003). Furthermore, the 95th percentile concentrations were calculated using only the surface water features that are included in the effects assessment, and not all stations that were monitored; this was done to derive a single set of upper limit baseline concentrations to use as a magnitude benchmark for all assessment locations. The 95th percentile concentrations for each lake, using the updated baseline dataset available to date, are presented in Tables 7a and 8a. Recognizing that there is some natural variation in concentrations of parameters, such as iron, aluminum and manganese between wetland stations and lakes, the single set of 95th percentile concentrations is generally similar to the individual lakes 95th percentile concentrations.

A comparison of the 95th percentile concentrations for the updated baseline dataset and the original baseline dataset used in the EA is presented in Table 9a. The 95th percentile concentrations of the two datasets are very similar, indicating that the use of the original dataset in the EA predictions is valid despite some stations previously having less than two years' worth of data.

A single set of upper baseline concentrations, rather than individual sets of baseline concentrations for each assessment location were applied to provide a consistent evaluation between the assessment locations and to avoid discrepancies when determining the magnitude level (i.e., Level I, II or III). Deriving the upper limit baseline concentrations for individual assessment locations would not change the outcome of the magnitude assessment, as a Level II magnitude was assigned for all Project phases and the Level III magnitude requires that the concentration be greater than both the 95th percentile concentration and the water quality guidelines, where applicable. Therefore, for the purposes of this EA, the baseline water quality calculated using the 95th percentile concentrations is appropriate for comparisons to the predicted water quality as part of the water quality effects assessment.

In response to reviewer comments, the 75th percentile concentrations of the updated baseline dataset are compared to the 95th percentile concentrations in Table 10a. Using the 75th percentile baseline concentrations as comparators to the model predicted values would not have changed the outcome of the magnitude assessment, as Level III magnitude would have required that the concentration be greater than both the 75th percentile concentration and the water quality guidelines, where applicable. While the 95th percentile baseline concentrations were used as comparators for predicted concentrations during the effects assessment for the EA, the 75th percentile concentrations may be used as an input to calculations for studies associated with the permitting process. When the time comes to apply for an Environmental Compliance Approval (ECA), following completion of the EA process, the requirements for deriving effluent criteria will follow Ontario Ministry of the Environment and Climate Change (MOECC) guidance, including application of the 75th percentile to background receiving water quality. Based on water quality modeling results, the effluent concentrations are predicted to be lower than the Metal Mining Effluent Regulations (MMER) and protective of aquatic life.

3.0 TOTAL PHOSPHORUS PREDICTIONS

In this section, discussions and data are provided to supplement the responses to Comments #205, 212, 213, 459, 683 and 690, which are related to:

- 1) predicted total phosphorus concentrations (including potential for changes to the trophic status of receivers); and
- 2) the effects of discharge from the proposed septic treatment system.

Further information is provided in the sections below.

3.1 Baseline Total Phosphorus Dataset And Predicted Total Phosphorus Concentrations

To satisfy reviewer comments related to the concentrations of total phosphorus predicted by GoldSim modeling, additional predictions of total phosphorus concentrations were conducted using the Lakeshore Capacity Assessment and its associated predictive model, the Lakeshore Capacity Model (LCM) (MOE et. al. 2010). The Lakeshore Capacity Assessment is a tool used to provide municipalities with guidance for land-use planning and development around lakes. The Lakeshore Capacity Model estimates total phosphorus concentrations in lakes located on the Precambrian Shield by predicting background (i.e., pre-development) total phosphorus concentrations and the amount of shoreline development that can occur while maintaining total phosphorus concentrations below a revised PWQO. The revised PWQO allows a 50% increase in total phosphorus concentration over the modeled pre-development background concentration.

The LCM is a steady-state mass balance model that estimates total phosphorus loading from natural sources (atmospheric deposition and catchment runoff) and anthropogenic sources (shoreline developments such as permanent, extended seasonal or seasonal residences, resorts, trailer parks, youth camps and campgrounds, vacant lots of record, agricultural and urban use, golf courses and other user-defined point sources). The model accounts for the movement of water and total phosphorus from upstream to downstream through the watershed. The model predicts total phosphorus concentrations in the lake under background, current and future development conditions. As stated in the LCM Users' Manual, the model uses coefficients that have been calibrated for lakes in south-central Ontario.

The key inputs and assumptions applied to the LCM are as follows:

- The hydrological flow regime was based on the existing site conditions as presented in Appendix I, Figure 3-1. The lakes were linked from upstream to downstream in both the Mollie River and Mesomikenda Lake watershed systems.
- The runoff input was based on regional estimates of runoff. As stated in Appendix I, Attachment I, the mean annual runoff for the region is in the range of 300 mm to 350 mm (Fisheries and Environment Canada 1978).
- The lake surface areas, lake catchment areas, and the percentages of catchments consisting of wetlands and cleared areas were derived from GIS calculations.
- The input average measured total phosphorus concentrations were calculated using data collected during spring turnover at water column profile stations in May 2013 and June 2014. Only data from the "top" samples (i.e., the upper 1 m of the water column) were used in the calculation. Outliers were excluded and values below the detection limit were assigned a concentration of one-half the detection limit.
- Anthropogenic inputs (i.e., the number of current shoreline developments) were provided by AMEC. Due to the remote location and small size of most of the lakes, it is assumed the majority of residences are seasonal cottages.

- A point source load was assigned to the Mesomikenda Lake Watershed LCM to account for effluent discharge from the polishing pond. The point source load was derived from the average total phosphorus load from the polishing pond under the average climatic condition (968 kg/year).
- Lakes with a surface area of less than 25 ha (Unnamed Lake #1, Little Clam Lake, Weeduck Lake, Côté Lake) are not modeled. The surface area and catchment area of these small lakes are added to the catchment area of the next lake downstream.
- Creeks and rivers (i.e., Bagsverd Creek, Somme River and the Mollie River) were not explicitly modeled. The percent wetland, percent cleared and catchment areas input into the model reflect the inputs of creeks and streams into the lakes.
- Lakes less than 5 m deep (Chester Lake and Delaney Lake) were considered to be “anoxic” – that is, the bottom sediments in the lakes are assumed to go anoxic; this assumption is as per the LCM Users’ Manual recommendations for shallow lakes. The LCM applies a lower settling velocity to shallow lakes subject to wind mixing to account for internal phosphorus loading (i.e., the release of phosphorus from sediments) occurring under anoxic conditions. Applying the default settling factor for deep stratified lakes to shallow lakes causes the LCM to underestimate the phosphorus concentration in the water column as it does not account for the phosphorus re-suspension during wind events. Therefore, assuming anoxic conditions for Chester Lake and Delaney Lake is a conservative approach to modeling phosphorus concentrations in these shallow lakes.
- Mesomikenda Lake was assigned as a lake trout lake (Appendix N; Table 3.1).

The inputs to the LCM are summarized in Tables 11a and 12a.

The applicability of the LCM to predict total phosphorus concentrations is assessed by comparing the model predictions against average total phosphorus concentrations measured in the “top” samples of the water column profiles during spring turnover. If the predicted and measured values are within 20% of each other, the model is deemed to be applicable for that lake.

The results of the LCM are presented in Table 13a and discussed by watershed in the sections below.

Mesomikenda Lake Watershed

The modeled spring total phosphorus concentration under existing conditions is 0.0143 mg/L for Neville Lake and 0.0116 mg/L for Mesomikenda Lake. These modeled values are within 4.1 and 19.5% of the measured concentrations of 0.015 mg/L and 0.00975 mg/L, respectively, and the LCM is therefore considered to be applicable to these lakes.

The PWQO for lakes on the Precambrian Shield allows a 50% increase in total phosphorus concentration from the modeled background concentration. The MOECC recognizes that there is some error associated with the model predictions (resulting from natural variability in total phosphorus concentrations over time and potential inaccuracies in model coefficients) and recommends that in cases where the predicted value is within 10% of the revised PWQO (i.e., between background plus 40% and background plus 60%) that flexibility be allowed when making management decisions. The revised PWQO (based on background plus 60%) is calculated to be 0.0219 mg/L for Neville Lake and 0.0174 mg/L for Mesomikenda Lake. The revised PWQO (based on background plus 50%) is calculated to be 0.0206 mg/L for Neville Lake and 0.0164 mg/L for Mesomikenda Lake.

The LCM-modeled future total phosphorus concentrations (accounting for total phosphorus loading from the polishing pond) are 0.0203 mg/L for Neville Lake and 0.0129 mg/L for Mesomikenda Lake. The predicted

concentrations in Neville Lake and Mesomikenda Lake are lower than the background total phosphorus concentrations increased by 50%.

The results of the LCM are similar to the annual average concentrations predicted by GoldSim for the average climatic condition (Table 13a). Under the average climatic condition, the GoldSim-predicted total phosphorus concentration in Neville Lake (0.0211 mg/L) is lower than the background total phosphorus concentration increased by 60%. Under the average climatic condition, the GoldSim-predicted total phosphorus concentration in Mesomikenda Lake (0.0145 mg/L) is lower than the background total phosphorus concentration increased by 50%.

The results of the LCM support the conclusion that the Project is not expected to exceed the lake-specific guideline values for phosphorous and the magnitude assigned in the Draft EA is unchanged. Although the average concentrations are expected to increase, any changes in phosphorus concentrations are not expected to materially change the dissolved oxygen with respect to the resident biota, nor cause a shift in the productivity of the lakes.

Mollie River Watershed

The modeled spring total phosphorus concentration under existing conditions for lakes in the Mollie River watershed system are varied by more than 20% from the measured concentrations in several of the lakes; as such, the LCM is not considered applicable to those lakes. The lakes of the Mollie River watershed fit the characteristics of lakes that, according to MOE et. al. (2010), fall beyond the calibration and test range of the model and may not be modeled accurately (i.e., shallow lakes, tea-stained lakes and lakes with small surface areas). The Mollie River Watershed may not model accurately for the following reasons:

- As presented in Appendix I, Attachment I, Table 12, several of the lakes in the Mollie River watershed are small (less than 25 ha). For small lakes, minor differences in surface area can significantly affect the model output.
- As presented in Appendix J, Attachment I, Appendix B, several of the lakes in the Mollie River system that had water column profile stations are shallow. The Chester Lake profile location was 2 m deep, the Delaney Lake profile location was 1.5 m deep, the Clam Lake profile location was 8 m deep, and the two Three Duck Lakes profile locations were 5 m and 7 m, respectively. The model does not account for phosphorus re-suspension during wind events and therefore may not accurately predict the loss of phosphorus to sediments in shallow lakes affected by wind action.
- The chain of lakes is connected by several small wetlands and creeks and functions much like a river system.
- The lakes are tea-stained and the average dissolved organic carbon (DOC) concentration is greater than 10 mg/L at Chester Lake, Clam Lake, Cote Lake, Weeduck Lake, Three Duck Lakes, Delaney Lake, Dividing Lake and at several small seasonal or beaver ponds (P-1, P-2, P-4, P-5 and P-7). Dillon and Molot (1997) found that the export (output rate or flux per unit area) of DOC from wetlands in a lake catchment affects water chemistry because it complexes and expedites the mobilization of total phosphorus. According to MOE et. al. (2010), the LCM is not calibrated for lakes with high DOC, as is common in northern Ontario.

As the LCM is not applicable to the Mollie River system, the predicted effects of the septic treatment system were assessed through modeling in GoldSim. The GoldSim-predicted concentrations of phosphorous were re-evaluated by accounting for solubility controls using the geochemical model PHREEQC.

During the construction and operation phases, the camp site sewage system is expected to be located upstream of Bagsverd Lake (south). Domestic sewage will be treated using a Waterloo Biofilter® Model 4 Bedroom system. The system contains a patented synthetic, absorbent filter medium that is configured as a free-draining, attached growth biological trickling filter to treat sewage. The system provides aerobic, anaerobic and anoxic environments for biological treatment. Bacteria colonize the filter medium surfaces and degrade and oxidize organic pollutants in the sewage (i.e., nitrate, ammonia and phosphorus).

The Waterloo Biofilter® Model 4 Bedroom system has been employed at comparable-sized operations in northern Ontario. Data from the treated side of the system at an analogous site was provided for review (Canadian Shield Consultants 2014, personal communication). Data from the analogous site were used as inputs to the water quality model to predict the effect of the proposed septic system on downstream receivers. Concentrations of nitrate, nitrite, total ammonia and total phosphorus measured monthly over a period of three years were averaged, and an attenuation factor of 25% was applied to the total phosphorus concentration to account for mass attenuation in the subsurface between the septic tile bed and the groundwater flow system. Studies by Ptacek (1998) and Robertson et. al. (1998) observed that phosphorus attenuation in the vadose zone ranged from 50% to 80%. Furthermore, based on data from a sampling port installed under the area bed at the analogous site, the concentrations of total phosphorus decreased by an order of magnitude from the treated side of the biofilter to the sampling port (Canadian Shield Consultants 2014, personal communication). Therefore, an attenuation factor of 25% is reasonable and conservative, in particular because the purpose of releasing the sewage effluent through a septic tile system is to attenuate some of the mass load prior to reaching the surface water environment.

The annual design sewage flow for the Waterloo Biofilter® Model 4 Bedroom system is 146,000 m³/year. The actual flow has been noted to vary from the design flow by 30 to 40% (Canadian Shield Consultants 2014, personal communication). To maintain consistency with these operational observations, the model assumes that the anticipated actual flow is 70% of the design flow (i.e., 102,200 m³/year).

The total phosphorus concentrations were predicted with solubility controls in Bagsverd Lake (south) and Three Duck Lakes (lower) for average, 1:25-year dry and 1:25-year wet climatic conditions. Solubility controls were applied to the predicted concentration of total phosphorus under each climatic condition using the equilibrium geochemical speciation/mass transfer model PHREEQC to account for geochemically creditable phases that are known to control phosphorus concentrations in the natural environment. Predicted concentrations with solubility controls applied are compared to PWQO in Table 14a.

Under the three climatic conditions, the predicted average total phosphorus concentrations in Bagsverd Lake (south) and Three Duck Lakes (lower) are lower than the PWQO. Based on the revised modelling, any changes in phosphorus concentrations are not expected to materially change the dissolved oxygen with respect to the resident biota, nor cause a shift in the productivity of the lakes.

The predicted nitrate, nitrite and total ammonia concentrations for Bagsverd Lake (south) and Three Duck Lakes (lower) for average, 1:25-year dry and 1:25-year wet climatic conditions are presented in Table 15a. The predicted average concentrations are compared to the PWQO and CWQG, where applicable. The predicted average nitrate concentrations in Bagsverd Lake (south) and Three Duck Lakes (lower) are below the CWQG of 13 mg/L (there is no PWQO for nitrate). The predicted average nitrite concentrations in Bagsverd Lake (south) and Three Duck Lakes (lower) are below the CWQG of 0.06 mg/L (there is no PWQO for nitrite). The predicted average un-ionized ammonia concentrations in Bagsverd Lake (south) and Three Duck Lakes (lower) are below the PWQO and the CWQG. The added nutrient load to the Mollie River Watershed is not predicted to change the magnitude levels, and therefore will not change the impact assessment conclusions. Additionally, IAMGOLD intends to implement best management practices, as required, to reduce the migration of nutrients from the

septic treatment system to the receiving environment; such as appropriate shoreline setback, the potential use of vegetative buffers to remove total phosphorus and appropriate septic system design (i.e., tile bed specifications, position of the bed with respect to the water table, site-specific soils investigations).

4.0 TOTAL SUSPENDED SOLIDS

In this section, discussions and data are provided to supplement the response to Comment #213, which included rationale for why predictions of total suspended solids (TSS) were not completed.

It is not appropriate to evaluate the effects of erosion and transport of TSS into the adjacent surface water features associated with the earthworks and other construction phase related activities, as these will be managed through the implementation of best management practices (BMPs). The implementation of BMPs for control of erosion and sediment transport during construction will consist of contingency planning, monitoring, erosion control measures, runoff management, sediment control measures and maintenance. The BMPs for erosion and sediment control are therefore expected to mitigate releases of suspended solids to the adjacent surface water bodies and limit potential changes to TSS concentrations. To model the TSS release from land disturbance during construction would not be appropriate as it would be modelling inefficiencies in these BMPs, whereas the water quality effects predictions are intended to be completed with mitigation measures in place. Contingency measures would be implemented in the event that erosion control measures were observed to be ineffective.

As part of the EA, TSS concentrations during operations were not modeled because the transport of TSS is highly influenced by site-specific hydrological conditions, particularly the design of the water management system. Engineered control structures, such as collection ponds and polishing ponds, are being incorporated into the pre-feasibility site design to allow for the settlement of suspended solids at specific points in the drainage collection system. As such, the engineered control measures will be designed and BMPs put in place to reduce the TSS concentrations to below the effluent discharge limits. However, in response to comments regarding the potential effects on TSS concentrations during operations, conservative calculations and additional modeling were completed to assess the effect that TSS discharged from the polishing pond would have on receiving surface water quality.

For the purposes of this analysis, the discharge of TSS was assumed to be conservatively high by using the Metal Mining Effluent Regulations (MMER) and Ontario Regulation 560/94 maximum permissible effluent TSS concentration of 15 mg/L as the TSS input concentration. In reality, the TSS concentration discharged from the polishing pond would be lower than the maximum permissible concentrations. The concentrations of various parameters comprising the TSS was estimated using the median elemental composition of all mine rock samples (n=236) as presented in Appendix E – Geochemical Characterization Report, Table 7-9, assuming a maximum TSS concentration of 15 mg/L. For example, the median calcium concentration of the mine rock samples is 1.45% and therefore the concentration of calcium in the TSS is 1.45% of 15 mg/L, or 0.218 mg/L.

The predicted minimum and maximum parameter concentrations in Neville Lake under average climatic conditions were simulated with and without TSS discharge and are compared in Table 16a. Even assuming a maximum TSS concentration of 15 mg/L from the polishing pond is predicted to have limited effect on the receiving surface water concentrations since the total dissolved solids load is predicted to be much higher than 15 mg/L; therefore, the TSS makes up only a small percentage of the overall load. The greatest differences are noted for aluminum and iron, which reflects typical concentrations of these parameters in the rock. Although the predicted maximum monthly average aluminum and iron concentrations with TSS discharge (0.086 mg/L and 0.22 mg/L, respectively) are higher than the predicted concentrations without TSS, the concentrations with TSS are within the range of baseline concentrations. Other parameters show negligible change in concentrations. As

such, accounting for discharge of TSS from the polishing pond does not materially change the conclusions of the water quality impact assessment.

5.0 TAILINGS GEOCHEMISTRY AND PROCESS WATER QUALITY

In this section, discussions and data are provided to supplement the responses to Comments #98, 100, 455 and 468, which are related to the water quality model assumptions for tailings loading rates and process water quality.

At the time of the effects prediction stage of the EA, and prior to the EA submission, no site-specific data was available for neither the geochemistry of the tailings nor the process water quality produced by the processing plant. For the purposes of the water quality modeling and effects predictions, the tailings geochemistry, including metal leaching characteristics, were assumed to be similar to the mine rock; as such, the model input for the tailings geochemistry was assigned based on MRA loading rates. Process water quality was derived using knowledge of analogue gold mining project sites and professional judgement; the exception was cyanide concentrations in the process water that were assumed based on the concept-level cyanide destruction treatment specifications provided by IAMGOLD.

At the time of the EIS/Draft EA submission, results were not yet available from humidity cell testing performed on three tailings samples produced for the Côté Gold Project. The samples were composites of various tailings prepared as part of IAMGOLD's bench-scale metallurgical testing program. The humidity cells were initiated in March of 2014. Preliminary geochemical source terms were provided by AMEC based on the average loading rates obtained over 18 weeks of testing of the three tailings humidity cells. Table 17a presents a comparison of the original versus new average tailings humidity cell loading rate input data. Furthermore, laboratory analysis was performed on the process water quality through an ageing test procedure on Day 0, Day 7, Day 29 and Day 60. Table 18a presents a comparison of the original versus new process water quality input data. The largest percent differences between the measured and assumed process water concentrations were for aluminum, boron, sodium, sulphate and vanadium. The measured total cyanide concentration was lower than the assumed value.

The new tailings humidity cell loading rates and process water quality data were input into the water quality model and predictions were re-simulated. The TMF reclaim pond has been designed to not discharge water to neither the mine water pond nor the polishing pond. The only expected discharge from the TMF to the receiving surface water environment is via seepage to the immediately adjacent Bagsverd Lake, Unnamed Lake and Bagsverd Creek, all located within the Mesomikenda Lake Watershed. It is important to note that seepage was incorporated into the simulations of both the original (i.e., as presented in the EA) and revised versions of the water quality model (this addendum). The Mollie River watershed does not receive seepage from the TMF, and the predicted water qualities for receivers in the Mollie River Watershed are therefore unchanged from those presented in the EA.

To assess the effect that applying the new tailings humidity cell loading rates and process water quality inputs have on the surface water receiving environment, the original predicted water qualities of key surface water features in the Mesomikenda Lake Watershed were compared to the revised predictions; these comparisons are presented in Table 19a. For the average, dry and wet year conditions, the following parameters show a marginal increase in concentrations due to the revised tailings humidity cell loading rates and process water quality data: aluminum, calcium, cobalt, copper, iron, molybdenum, nitrate, potassium, sodium, strontium and sulphate. For the average, dry and wet year conditions, the following parameter concentrations were unchanged due to the revised tailings humidity cell loading rates and process water quality data: total ammonia, un-ionized ammonia, antimony, arsenic, boron, cadmium, chloride, lead, manganese, nickel, total phosphorus, uranium, vanadium

and zinc. For the average, dry and wet year conditions, the following parameters show a decrease in concentrations due to the revised tailings humidity cell loading rates and process water quality data: barium, cyanide (total), cyanide (free) and magnesium.

The limited change to the water quality predictions is related to the transport pathway between the TMF and the surface water receiver, which is through seepage, and only under a conservative assumed scenario of full mine operations. Because the seepage rates that bypass the seepage collection system are low relative to the flow in the surface water receivers (e.g., Bagsverd Creek), changes to the seepage water concentrations have limited effect on the overall mass load within the surface water environment. As such, the revised tailings humidity cell loading rates and process water quality inputs did not result in material changes to the effects predictions or conclusions of the water quality impact assessment. The original model assumptions for tailings geochemistry and process water quality were therefore reasonable and the revised model results do not change the outcome of the impact assessment.

6.0 SEEPAGE LOADING RATES

In this section, a discussion and data are provided to supplement the response to Comment #88, which is related to the water quality model assumptions for loading rates from seepage from the tailings management facility and mine rock area.

Estimates of seepage that bypass the collection system and discharges into the surface water environment were accounted for in the water quality effects predictions completed for the draft EA. The water quality model assumes a loading rate into surface water features due to seepage from the MRA and TMF. The seepage, and associated mass load, from the low-grade ore stockpile is assumed to report to the open pit, as the drawdown cone due to dewatering of the open pit extends beyond the perimeter of the low-grade ore stockpile; the low-grade ore stockpile is assumed to be processed prior to closure and will not be present during the post-closure phase.

Seepage from the MRA is assumed to report to Chester Lake, Three Duck Lakes, Delaney Lake and a portion of the Mollie River system feeding Dividing Lake, and in part to the open pit during the operations phase. The MRA seepage was allocated based on estimated bypass flows as presented in the Hydrogeology TSD Addendum. Seepage from the TMF is assumed to report to Bagsverd Lake, Un-named Lake #1, Un-named Lake #2 and Bagsverd Creek. The seepage loading rates from the MRA and TMF are presented in Table 20a.

7.0 COMPARISON CRITERIA FOR PREDICTED FREE CYANIDE CONCENTRATIONS

In this section, a discussion and data are provided to supplement the response to Comment #679, which is related to comparison criteria applied to predicted free cyanide concentrations in water bodies receiving seepage from the TMF.

To provide context for the water quality results, and to evaluate the potential for changes to water quality that may result in adverse effects, the predicted monthly average parameter concentrations presented in the EA were compared to baseline concentrations and a single set of *Water Quality Guidelines*. The set of *Water Quality Guidelines* are a compilation of the most recent of the PWQOs or CWQGs for each parameter, and for parameters where a PWQO/CWQG does not exist, the BCWQG were used. The PWQO for free cyanide was developed prior to 1979 and is based on toxicity data from the 1950s and 60s (MOE 1979); the PWQO for free cyanide, therefore, is based on scientific data that is decades old and does not take into account the more recent data on cyanide toxicity. The CWQG for free cyanide is based on the PWQO, and also does not include any more recent data than the PWQO. Neither the PWQO nor the CWQG for free cyanide has been updated since

1984. A free cyanide effects benchmark of 0.0098 mg/L was taken from a recent study that reviewed and updated the current state of understanding of aquatic chemistry and toxicity of cyanide and conducted new aquatic toxicity studies to fill knowledge gaps; this study is presented in: Water Environment Research Foundation (WERF) document *Scientific Review of Cyanide Ecotoxicology and Evaluation of Ambient Water Quality Criteria*. The study presented in WERF (2007) developed a freshwater final chronic value of 0.009784 mg/L that is protective of aquatic life (excluding salmonids) using scientifically sound methods and updated toxicity data. This benchmark is applied as part of the water quality effects/risk assessment to evaluate whether the predicted free cyanide concentrations in non-salmonid bearing waters would result in adverse effects on aquatic life. For salmonid bearing waters, such as Mesomikenda Lake, the predicted concentrations of free cyanide are below the PWQO and CWQG of 0.005 mg/L, and thus comparisons of predicted Mesomikenda Lake free cyanide concentrations to the 0.0098 mg/L value are not relevant. The WERF criterion of 0.0098 mg/L is a conservatively derived, scientifically sound benchmark that is protective of aquatic life in non-salmonid bearing waters and has been previously used in environmental impact assessments as a suitable benchmark for assessing the effects of free cyanide.

Reviewer comments suggested that predicted free cyanide concentrations be compared to the PWQO and CWQG instead of the WERF (2007) benchmark. At the time of the effects prediction stage of the EA, and prior to the EA submission, no site-specific data was available for the process water quality produced by the processing plant. For the purposes of the water quality modeling, process water quality was derived using knowledge of analogue gold mining project sites and professional judgement; the exception was cyanide concentrations in the process water that were assumed based on the concept-level cyanide destruction treatment specifications. Subsequent to the EA submission, humidity cell testing was performed on three tailings samples produced for the Côté Gold Project and laboratory analysis was performed on the process water quality through an ageing test procedure. The new tailings humidity cell loading rates and process water quality data were input into the water quality model and predictions were re-simulated. The modeled free cyanide concentrations now account for natural attenuation of cyanide in the vadose zone of the TMF, whereas the predictions presented previously in the Water Quality TSD (i.e., as part of the EIS/Draft EA) did not account for attenuation. Cyanide concentrations in the shallow tailings (i.e., vadose zone) have been shown to decrease over time via volatilization, precipitation, complexation, adsorption and biodegradation (Engelhardt 1985; Smith and Struhsacker 1987; Church and Boyle 1990; Oudjehani et. al. 2002; Zagury et. al. 2004).

The revised predicted monthly average concentrations of free cyanide for water bodies in the Mesomikenda Lake Watershed under the average climatic condition, the 1:25-year dry condition and the 1:25-year wet condition as compared to the PWQO are presented in Table 21a and shown on Figure 4a. Under the average, 1:25-year wet and 1:25-year dry conditions, the predicted monthly average and absolute maximum free cyanide concentrations are below the PWQO and CWQG for all months and all water bodies. The free cyanide concentrations predicted in the revised model are based on a newly available process water concentration instead of an assumed concentration, and are lower than those predicted in the original model. Therefore, with respect to predicted free cyanide concentrations, the revised predictions do not result in a change in magnitude levels, and the conclusions of the water quality effects assessment are unchanged.

8.0 APPLICATION OF MINE ROCK HUMIDITY CELL TEST DATA

In this section, a discussion and data are provided to supplement responses to Comments #94, 452 and 461, which are related to:

- 1) the water quality model assumptions for arsenic loading rates from the mine rock area; and
- 2) the predictions of contact water quality from the open pit walls during post-closure.

Further information is provided in the sections below.

8.1 Arsenic Loading Rates

The water quality model was updated with the most recent humidity cell data for arsenic (to week 75) and simulations were completed by equitably applying the diorite humidity cell loading rates to the total tonnage of diorite. As such, in the revised model, the “higher arsenic” and “lower arsenic” mine rock tonnage designations that were weighted in the original model were removed to evaluate the potential differences in arsenic concentrations when deriving a mass loading rate from the total tonnage of diorite by equally weighting the updated loading rates from all the diorite humidity cells. A comparison of the original and revised model input arsenic loading rates is presented in Table 22a. The results of the simulation with the revised model inputs with respect to arsenic concentrations are presented in Table 23a and 24a. Due to the decrease in the arsenic loading rates from all the humidity cell tests over time, the updated results did not result in a material change to the arsenic concentrations in the surface water receiving environment. Therefore, the conclusions of the effects predictions presented in the EA are unchanged.

8.2 Predicted Pit Wall Loadings

The open pit mine walls consist of the following: tonalite, magma mixing breccia, diorite, diorite breccia, diorite mega breccia, mafic dykes, quartz diorite, diabase, intrusive feldspar porphyry, intrusive mafic lamprophyre, fault, intermediate and felsic dykes, fault breccia, quartz carbonate heterolithic breccia, quartz sericite schist, mafic breccia and hydrothermal breccia. For a discussion on the geochemistry of the rock in the open pit, see Appendix E, Section 7.0.

The water quality model assumes a reactive thickness of 1 m across the exposed area of 1,924,856 m² (ultimate pit extent area) for the water quality predictions. This is a conservative assumption and the reactive volume (1,924,856 m³) takes into consideration any surface area effects that rock collapse and the formation of talus’ on pit benches may have on the mass loading within the open pit.

As described in Appendix I, the water level in the Côté Pit lake during post-closure (stage II) will have recovered to an elevation sufficient to cause overflow (and reconnection) of the pit lake to the upper basin of Three Duck Lakes. As shown in Appendix I, Attachment II, Appendix C, Table C-2, the average annual water level of water the Côté Pit lake under average conditions during post-closure (stage II) is predicted to be 380.2 metres above sea level. Knight Piesold conducted a pre-feasibility slope design study for the proposed open pit (Knight Piesold 2013). Acknowledging that open pit design is ongoing, the proposed pit outline indicates that very little bedrock will remain exposed on the pit wall after flooding, and will be limited to localized topographical highs. This is illustrated in Figure 5a that shows the flooded pit to a water level of 380.2 metres above sea level. The exposed bedrock (almost entirely tonalite) is predicted to be non-acid generating (Appendix E). The predominant lithology exposed at the pit edge (tonalite) was classified based on laboratory strength testing as good quality rock. Pit slope angles will be designed such that pit walls will be physically stable over the longer term under flooded conditions.

9.0 CONCLUDING REMARKS

Additional water quality modeling and interpretation of predicted results was completed to refine the water quality predictions for the Project given recently available data with respect to site-specific tailings geochemistry, process water quality and mine rock humidity cell testing. The updated modeling incorporated predictions of effects from the proposed sewage treatment system and total suspended solids in the polishing pond effluent.

Predicted concentrations of total phosphorus were re-evaluated using the Lakeshore Capacity Model, and where appropriate, against lake-specific phosphorus water quality objectives.

The additional modeling and analysis support the conclusions presented in the EIS/Draft EA. Practical engineering controls and environmental monitoring and mitigation plans will help to strengthen these conclusions during each of the project phases.

10.0 REFERENCES

- British Columbia Ministry of Environment, Lands and Parks. 1997. Methods for Deriving Site-Specific Water Quality Objectives in British Columbia and Yukon. Waste Management Branch. November 1997.
- Canadian Shield Consultants. September 11, 2014. Email communication from P. Whissell. Includes attachments "Data Summary for Waterloo Biofilter® Model 4 Bedroom Under the EPA ETV Water Quality Protection Center" and a letter from Canadian Shield Consultants to David Brown, Manager of Environmental Services, IAMGOLD Corporation, September 10, 2014.
- Canadian Council of Ministers of the Environment. 2003. Guidance on the Site-Specific Application of Water Quality Guidelines in Canada: Procedures for Deriving Numerical Water Quality Objectives. In: Canadian Environmental Quality Guidelines. 1999. Canadian Council of Ministers of the Environment, Winnipeg.
- Church, R.H. and Boyle, J.R. 1990. A study of long term cyanide residuals at an historically significant site. In: Proceedings of the western regional symposium on mining and mineral processing wastes, Berkeley, California, 30 May- 1 June.
- Dillon, P.J. and Molot, L.A. 1997. Effect of landscape form on export of dissolved organic carbon, iron and phosphorus from forested stream catchments. Water Resources Research, Vol. 33, No. 11, Pages 2591-2600.
- Englehardt, P.R. 1985. Long-term degradation of cyanide in an inactive leach heap. In: Van Zyl D (ed) Cyanide and the environment: proceedings of a conference, Tuscon, Arizona, 11-14 December, 1984, vol. 2. Department of Civil Engineering, Colorado State University, Fort Collins, Colorado.
- Fisheries and Environment Canada. 1978. Hydrological Atlas of Canada.
- Hill, J.R., S.R. Roe, U. Schneider, and L. Swain. 2006. The challenge and necessity of estimating natural background for site-specific Canadian Water Quality Guidelines. Presented at the 27th Annual Meeting of the Society of Environmental Toxicology and Chemistry, Palais des Congres, Montreal, Quebec, 5-9 November, 2006.
- Knight Piesold. 2013. Open Pit Slope Design, IAMGOLD Corporation, Côté Gold Project. NB101-497/2-1. January 2013.
- Ministry of the Environment, Ministry of Natural Resources, Ministry of Municipal Affairs and Housing. 2010. Lakeshore Capacity Assessment Handbook Protecting Water Quality in Inland Lakes on Ontario's Precambrian Shield. Dated May 2010.
- Ministry of the Environment, Ministry of Natural Resources, Ministry of Municipal Affairs and Housing. 2010. Lakeshore Capacity Assessment Handbook Protecting Water Quality in Inland Lakes on Ontario's Precambrian Shield. Dated May 2010.

- Ministry of the Environment. 1999. Provincial Water Quality Objectives, PIBS 3303E, Queen's Printer for Ontario. July 1994, reprinted February 1999.
- Ministry of the Environment. 1979. Rationale for the Establishment of Ontario's Provincial Water Quality Objectives. September 1979.
- Oudjehani, K. , Zagury, G.J. and Deschenes, L. 2002. Natural attenuation potential of cyanide via microbial activity in mine tailings. Appl Microbiol Biotechnol 58: 409-415.
- Ptacek, C.J. 1998. Geochemistry of a septic-system plume in a coastal barrier bar, Point Pelee, Ontario, Canada. Journal of Contaminant Hydrology 33: 293-312.
- Robertson, W.D., Schiff, S.L., and Ptacek, C.J. 1998. Review of Phosphate Mobility and Persistence in 10 Septic System Plumes. Ground Water Vol. 36, No. 6.
- Roe, S., Hill, J., Schneider, U. and L. Swain. 2006. Re-thinking the Background Approach to Setting Site-specific Water Quality Guidelines (SSGs). Presented at 33rd Aquatic Toxicity Workshop, Jasper, Alberta. October 1-4, 2006.
- Water Environment Research Foundation. 2007. Scientific Review of Cyanide Ecotoxicology and Evaluation of Ambient Water Quality Criteria. WERF Report 01-ECO-1.
- Zagury, G.J., Oudjehani, K. and Deschenes, L. 2004. Characterization and availability of cyanide in solid mine tailings fom gold extraction plants. Science of the Total Environment 320: 211-224.

GOLDER ASSOCIATES LTD.



Natalie Korczak, M.Sc., P.Geo.
Geochemist



Mike Gunsinger, M.Sc., P.Geo.
Associate

NK/MRG/lis

Attachments: Tables 1a to 24a
Figures 1a to 5a

m:\active\2014\1190 sudbury\1192\1400877 iamgold ea follow-up gogama\reporting\responses to regulators\3. water quality addendum\1400877r2_15jan19_revised_iamgold_ea_addendum_water_quality.docx

TABLE 1a
STATISTICAL SUMMARY OF UPDATED BASELINE SURFACE WATER QUALITY DATASET - MOLLIE RIVER WATERSHED
CÔTÉ GOLD PROJECT

Parameter	Unit	P-1 (n=1)	P-5 - Seasonal Pond (n=6)								CM-LS - Clam Lake (Lake Station) (n=10)								CM - Culvert Road Crossing of Clam Lake (n=26)								
		Data ¹	Minimum	Maximum	Average	Standard Deviation	25 th percentile	Median	75 th percentile	95 th percentile	Minimum	Maximum	Average	Standard Deviation	25 th percentile	Median	75 th percentile	95 th percentile	Minimum	Maximum	Average	Standard Deviation	25 th percentile	Median	75 th percentile	95 th percentile	
FIELD PARAMETERS																											
pH	pH units	6.87	5.69	6.98	6.19	0.41	5.92	6.13	6.29	6.80	5.49	7.83	6.95	0.61	6.84	7.10	7.22	7.70	5.54	8.48	6.97	0.65	6.66	6.99	7.35	7.90	
Temperature	degrees Celsius	-0.10	0.020	20	8.1	7.4	1.2	6.6	14	18	1.9	21	11	5.9	7.8	10	21	-1.0	27	8.4	8.9	1.3	3.1	18	25		
Conductivity	µS/cm	26	13	53	29	13	19	26	35	49	38	131	62	35	39	45	59	131	20	58	30	9.5	25	25	34	48	
Dissolved Oxygen (DO)	mg/L	8.1	1.6	11	7.6	3.2	6.4	8.4	9.8	10.9	0.69	117	20	32	9.5	12	12	70	1.2	19	9.1	4.5	6.2	8.8	13	16	
GENERAL PARAMETERS																											
Lab pH	pH units	6.42	5.86	6.55	6.19	0.27	5.98	6.14	6.44	6.50	6.08	6.91	6.55	0.29	6.34	6.57	6.82	6.90	6.02	7.13	6.63	0.26	6.44	6.61	6.80	7.00	
Alkalinity	mg/L as CaCO ₃	16	2.5	21	11	6.1	7.3	9.0	15	20	11	17	13	1.8	11	12	14	16	9.0	17	13	1.6	13	14	14	16	
Electrical Conductivity (EC)	µS/cm	51	26	60	41	11	33	40	46	57	39	50	42	3.1	40	42	48	36	52	44	3.7	41	43	46	50		
Total Dissolved Solids (TDS)	mg/L	28	46	82	62	12	53	61	70	80	10	50	35	12	27	38	44	48	10	86	37	15	28	37	47	50	
Total Suspended Solids (TSS)	mg/L	<1.0	1.0	8.0	3.8	2.7	1.3	3.5	5.8	7.5	0.50	5.0	4.2	1.7	5.0	5.0	5.0	5.0	0.50	5.8	3.7	1.8	2.0	5.0	5.0	5.0	
Total Hardness	mg/L as CaCO ₃	24	13	29	21	5.4	17	20	24	28	17	23	19	2.0	18	19	20	22	15	24	19	2.0	18	19	20	22	
Dissolved Organic Carbon (DOC)	mg/L	16	13	35	24	6.7	23	23	25	33	6.7	11	8.4	1.4	7.4	8.3	9.2	10.6	5.7	11	8.1	1.1	7.2	7.9	8.7	10.0	
MAJOR IONS																											
Calcium (Ca)	mg/L	7.6	4.0	9.4	6.5	1.8	5.4	6.2	7.6	9.0	5.3	7.5	6.1	0.64	5.7	6.0	6.5	7.2	4.9	7.9	6.2	0.66	5.8	6.3	6.5	7.3	
Magnesium (Mg)	mg/L	1.3	0.72	1.4	1.1	0.24	0.91	1.1	1.3	1.4	0.79	1.1	0.89	0.086	0.83	0.87	0.96	1.03	0.67	1.1	0.92	0.093	0.86	0.92	0.98	1.04	
Potassium (K)	mg/L	0.32	0.22	0.90	0.58	0.20	0.54	0.59	0.63	0.83	0.31	0.47	0.39	0.045	0.36	0.39	0.41	0.46	0.27	0.93	0.40	0.12	0.35	0.38	0.42	0.47	
Sodium (Na)	mg/L	0.71	0.63	1.0	0.84	0.14	0.73	0.90	0.92	1.00	0.62	0.84	0.72	0.077	0.63	0.73	0.78	0.82	0.55	0.82	0.69	0.052	0.67	0.69	0.72	0.75	
Chloride (Cl)	mg/L	0.33	0.27	0.75	0.41	0.16	0.31	0.36	0.42	0.67	0.24	0.45	0.33	0.059	0.30	0.31	0.35	0.43	0.24	0.48	0.34	0.053	0.29	0.34	0.36	0.44	
Fluoride (F)	mg/L	<0.05	<0.05	<0.05	<0.05	-	<0.05	<0.05	<0.05	<0.05	<0.05	<0.05	<0.05	<0.05	<0.05	<0.05	<0.05	<0.05	<0.05	<0.05	<0.05	-	<0.05	<0.05	<0.05	<0.05	
Sulphate (SO ₄)	mg/L	2.8	0.30	3.4	1.6	1.1	0.62	1.7	2.1	3.1	3.0	3.8	3.4	0.29	3.1	3.4	3.6	3.8	2.5	4.9	3.6	0.61	3.2	3.7	4.0	4.8	
METALS																											
Aluminum (Al)	mg/L	0.040	0.037	0.097	0.078	0.020	0.078	0.081	0.091	0.096	0.0070	0.16	0.040	0.044	0.014	0.029	0.044	0.112	0.0040	0.078	0.020	0.017	0.0073	0.018	0.026	0.050	
Antimony (Sb)	mg/L	<0.006	<0.006	<0.006	<0.006	-	<0.006	<0.006	<0.006	<0.006	0.0015	0.0030	0.0018	0.00060	0.0015	0.0015	0.0015	0.0030	<0.006	<0.006	<0.006	-	<0.006	<0.006	<0.006	<0.006	
Arsenic (As)	mg/L	<0.003	<0.003	<0.003	<0.003	-	<0.003	<0.003	<0.003	<0.003	<0.003	<0.003	<0.003	-	<0.003	<0.003	<0.003	<0.003	<0.003	<0.003	<0.003	-	<0.003	<0.003	<0.003	<0.003	
Barium (Ba)	mg/L	0.0090	0.0050	0.010	0.0068	0.0018	0.0053	0.0065	0.0078	0.0095	0.0030	0.0070	0.0047	0.0013	0.0040	0.0040	0.0055	0.0070	0.0030	0.0060	0.0042	0.00088	0.0040	0.0040	0.0048	0.0060	
Beryllium (Be)	mg/L	<0.001	<0.001	<0.001	<0.001	-	<0.001	<0.001	<0.001	<0.001	<0.001	<0.001	<0.001	-	<0.001	<0.001	<0.001	<0.001	<0.001	<0.001	<0.001	-	<0.001	<0.001	<0.001	<0.001	
Boron (B)	mg/L	<0.01	<0.01	<0.01	<0.01	-	<0.01	<0.01	<0.01	<0.01	<0.01	<0.01	<0.01	-	<0.01	<0.01	<0.01	<0.01	<0.01	<0.01	<0.01	-	<0.01	<0.01	<0.01	<0.01	
Cadmium (Cd)	mg/L	<0.0001	0.000010	0.000050	0.000030	0.000020	0.000010	0.000030	0.000050	0.000050	0.000010	0.00010	0.000023	0.000028	0.000010	0.000010	0.000010	0.000077	0.000010	0.000050	0.000039	0.000018	0.000020	0.000050	0.000050	0.000050	
Chromium (Cr)	mg/L	<0.003	<0.003	<0.003	<0.003	-	<0.003	<0.003	<0.003	<0.003	<0.003	<0.003	<0.003	-	<0.003	<0.003	<0.003	<0.003	<0.003	<0.003	<0.003	-	<0.003	<0.003	<0.003	<0.003	
Cobalt (Co)	mg/L	<0.0005	0.00025	0.0012	0.00041	0.00035	0.00025	0.00025	0.00025	0.00025	<0.0005	<0.0005	<0.0005	-	<0.0005	<0.0005	<0.0005	<0.0005	<0.0005	<0.0005	<0.0005	-	<0.0005	<0.0005	<0.0005	<0.0005	
Copper (Cu)	mg/L	<0.002	0.00060	0.0010	0.00087	0.00016	0.00075	0.00095	0.0010	0.0010	0.0010	0.0020	0.0013	0.00031	0.0011	0.0012	0.0016	0.0018	0.0010	0.0027	0.0012	0.00038	0.0010	0.0010	0.0011	0.0019	
Iron (Fe)	mg/L	0.24	0.23	0.90	0.39	0.23	0.25	0.30	0.37	0.77	0.0050	0.41	0.11	0.13	0.038	0.040	0.10	0.35	0.0050	0.29	0.077	0.067	0.035	0.051	0.092	0.222	
Lead (Pb)	mg/L	<0.001	0.00020	0.00050	0.00037	0.00014	0.00023	0.00040	0.00050	0.00050	0.0010	0.0020	0.00020	0.00030	0.000050	0.000050	0.000088	0.000775	0.000050	0.00050	0.00038	0.00019	0.00020	0.00050	0.00050	0.00050	
Manganese (Mn)	mg/L	0.072	0.016	0.41	0.10	0.14	0.028	0.043	0.061	0.324	0.0070	0.39	0.075	0.12	0.017	0.021	0.041	0.296	0.0030	0.058	0.017	0.013	0.0083	0.013	0.018	0.039	
Mercury (Hg)	mg/L	<0.0001	0.0000015	0.000050	0.000034	0.000022	0.000015	0.000050	0.000050	0.000050	0.0000095	0.000050	0.000013	0.000019	0.0000095	0.0000095	0.000014	0.000050	0.0000095	0.000050	0.000037	0.000022	0.000040	0.000050	0.000050	0.000050	
Molybdenum (Mo)	mg/L	<0.002	<0.002	<0.002	<0.002	-	<0.002	<0.002	<0.002	<0.002	<0.002	<0.002	<0.002	-	<0.002	<0.002	<0.002	<0.002	<0.002	<0.002	<0.002	-	<0.002	<0.002	<0.002	<0.002	
Nickel (Ni)	mg/L	<0.003	<0.003	<0.003	<0.003	-	<0.003	<0.003	<0.003	<0.003	<0.003	<0.003	<0.003	-	<0.003	<0.003	<0.003	<0.003	<0.003	<0.003	<0.003	-	<0.003	<0.003	<0.003	<0.003	
Selenium (Se)	mg/L	<0.004	0.000050	0.00020	0.0010	0.00098	0.000050	0.0010	0.0020	0.0020	0.000050	0.0020	0.00044	0.00078	0.000050	0.000050	0.000050	0.002000	0.000050	0.00020	0.00015	0.00085	0.00065	0.00020	0.00020	0.0020	
Silver (Ag)	mg/L	<0.0001	0.0000050	0.000050	0.000028	0.000022	0.000063	0.000030	0.000050	0.000050	0.0000050	0.000050	0.000016	0.000018	0.0000050	0.0000050	0.000018	0.000050	0.0000050	0.00010	0.000040	0.000023	0.000016	0.000050	0.000050	0.000050	
Strontium (Sr)	mg/L	0.016	0.0080	0.020	0.014	0.0039	0.012	0.014	0.016	0.019	0.010	0.015	0.012	0.0014	0.011	0.012	0.013	0.015	0.010	0.017	0.013	0.0017	0.012	0.013	0.014	0.017	
Thallium (Tl)	mg/L	<0.0003	0.0000050	0.00015	0.000078	0.000073	0.000050	0.000078	0.00015	0.00015	0.0000050	0.00015	0.000035	0.000058	0.0000050	0.0000050	0.000088	0.0001500	0.0000050	0.00015	0.00011	0.000064	0.000041	0.00015	0.00015	0.00015	
Titanium (Ti)	mg/L	<0.002	0.0010	0.0050	0.0018	0.0015	0.0010	0.0010	0.0018	0.0043	<0.002	<0.002	<0.002	-	<0.002	<0.002	<0.002	<0.002	0.0010	0.0030	0.0011	0.00042	0.0010	0.0010	0.0010	0.0018	
Tungsten (W)	mg/L	<0.01	<0.01	<0.01	<																						

TABLE 1a
STATISTICAL SUMMARY OF UPDATED BASELINE SURFACE WATER QUALITY DATASET - MOLLIE RIVER WATERSHED
CÔTÉ GOLD PROJECT

Parameter	Unit	CL - Côté Lake Outlet (n=30)								WD - Weeduck Lake Outlet (n=30)								MP - Inflow to Three Duck Lakes (n=27)							
		Minimum	Maximum	Average	Standard Deviation	25 th percentile	Median	75 th percentile	95 th percentile	Minimum	Maximum	Average	Standard Deviation	25 th percentile	Median	75 th percentile	95 th percentile	Minimum	Maximum	Average	Standard Deviation	25 th percentile	Median	75 th percentile	95 th percentile
FIELD PARAMETERS																									
pH	pH units	5.20	7.52	6.83	0.48	6.71	6.92	7.07	7.40	5.56	8.14	7.12	0.54	6.84	7.22	7.50	7.90	5.73	7.79	6.51	0.43	6.21	6.53	6.70	7.00
Temperature	degrees Celsius	-1.3	24	8.5	8.8	0.30	4.1	18	22	-0.20	24	8.7	0.77	5.8	18	24	-0.30	21	7.3	7.9	0.070	2.9	15	21	
Conductivity	µS/cm	20	49	32	8.1	25	29	37	44	16	42	28	6.8	23	25	33	39	26	82	45	13	35	42	52	65
Dissolved Oxygen (DO)	mg/L	4.9	18	9.9	2.8	8.3	9.8	11	15	1.2	19	8.7	3.7	7.2	8.3	11	13	2.6	12	7.5	2.9	4.6	7.2	11	12
GENERAL PARAMETERS																									
Lab pH	pH units	5.79	7.45	6.65	0.36	6.44	6.67	6.89	7.10	5.80	7.26	6.60	0.40	6.31	6.72	6.93	7.10	5.93	7.23	6.63	0.36	6.30	6.70	6.87	7.20
Alkalinity	mg/L as CaCO ₃	8.0	30	14	3.8	12	13	15	19	2.5	15	12	2.3	12	13	14	9.0	31	19	5.9	15	21	23	29	
Electrical Conductivity (EC)	µS/cm	33	57	45	5.4	43	46	49	54	26	45	39	3.5	37	38	40	44	50	97	68	11	62	66	74	87
Total Dissolved Solids (TDS)	mg/L	28	524	69	85	44	54	60	81	10	82	36	15	28	35	44	55	42	100	68	15	56	68	78	96
Total Suspended Solids (TSS)	mg/L	0.50	5.0	3.1	1.7	2.0	3.0	5.0	5.0	0.50	5.0	2.9	2.0	0.63	3.0	5.0	5.0	0.50	5.0	2.8	2.0	1.0	2.0	5.0	5.0
Total Hardness	mg/L as CaCO ₃	17	27	22	2.6	20	22	23	26	12	21	18	1.7	17	18	20	23	41	31	5.1	27	30	34	40	
Dissolved Organic Carbon (DOC)	mg/L	11	27	13	2.8	12	13	14	16	6.1	173	14	30	7.8	8.3	9.7	13.9	12	21	17	2.4	14	16	19	21
MAJOR IONS																									
Calcium (Ca)	mg/L	5.2	8.2	6.8	0.80	6.3	6.9	7.3	8.2	3.5	6.2	5.2	0.51	4.9	5.2	5.4	5.9	7.2	13	9.6	1.6	8.5	9.5	11	12
Magnesium (Mg)	mg/L	0.89	1.5	1.2	0.15	1.1	1.2	1.3	1.4	0.77	1.4	1.1	0.12	1.1	1.1	1.2	1.3	1.2	2.4	1.6	0.28	1.4	1.5	1.8	2.1
Potassium (K)	mg/L	0.22	0.45	0.33	0.060	0.29	0.33	0.39	0.42	0.31	0.52	0.40	0.057	0.37	0.39	0.44	0.52	0.27	0.86	0.63	0.14	0.55	0.63	0.74	0.83
Sodium (Na)	mg/L	0.76	1.3	0.95	0.12	0.85	0.94	1.0	1.1	0.54	0.85	0.69	0.076	0.63	0.66	0.75	0.83	1.0	2.7	1.9	0.50	1.5	1.9	2.4	2.6
Chloride (Cl)	mg/L	0.27	1.3	0.63	0.21	0.53	0.62	0.69	1.01	0.20	0.52	0.33	0.093	0.27	0.32	0.37	0.51	1.1	4.6	2.8	1.1	1.9	2.7	3.9	4.1
Fluoride (F)	mg/L	<0.05	<0.05	<0.05	-	<0.05	<0.05	<0.05	<0.05	<0.05	<0.05	<0.05	-	<0.05	<0.05	<0.05	<0.05	<0.05	<0.05	<0.05	<0.05	<0.05	<0.05	<0.05	<0.05
Sulphate (SO ₄)	mg/L	1.8	3.7	2.9	0.52	2.5	2.9	3.2	3.7	1.7	2.8	2.3	0.27	2.1	2.3	2.4	2.7	1.6	14	4.8	2.5	3.3	4.2	5.4	8.1
METALS																									
Aluminum (Al)	mg/L	0.015	0.095	0.057	0.021	0.042	0.055	0.073	0.088	0.0020	0.029	0.010	0.0062	0.0060	0.0090	0.013	0.022	0.068	0.19	0.11	0.029	0.084	0.099	0.13	0.14
Antimony (Sb)	mg/L	<0.006	<0.006	<0.006	-	<0.006	<0.006	<0.006	<0.006	<0.006	<0.006	<0.006	-	<0.006	<0.006	<0.006	<0.006	<0.006	<0.006	<0.006	-	<0.006	<0.006	<0.006	<0.006
Arsenic (As)	mg/L	<0.003	<0.003	<0.003	-	<0.003	<0.003	<0.003	<0.003	<0.003	<0.003	<0.003	-	<0.003	<0.003	<0.003	<0.003	<0.003	<0.003	<0.003	-	<0.003	<0.003	<0.003	<0.003
Barium (Ba)	mg/L	0.0030	0.0070	0.0051	0.00096	0.0040	0.0050	0.0060	0.0066	0.0030	0.0060	0.0051	0.00081	0.0050	0.0050	0.0060	0.0060	0.0050	0.011	0.0074	0.0016	0.0060	0.0070	0.0080	0.0107
Beryllium (Be)	mg/L	<0.001	<0.001	<0.001	-	<0.001	<0.001	<0.001	<0.001	<0.001	<0.001	<0.001	-	<0.001	<0.001	<0.001	<0.001	<0.001	<0.001	<0.001	-	<0.001	<0.001	<0.001	<0.001
Boron (B)	mg/L	<0.01	<0.01	<0.01	-	<0.01	<0.01	<0.01	<0.01	<0.01	<0.01	<0.01	-	<0.01	<0.01	<0.01	<0.01	<0.01	<0.01	<0.01	-	<0.01	<0.01	<0.01	<0.01
Cadmium (Cd)	mg/L	0.000010	0.00030	0.000049	0.000050	0.000050	0.000050	0.000050	0.000050	0.000010	0.000050	0.000041	0.000017	0.000050	0.000050	0.000050	0.000050	0.000010	0.000050	0.000042	0.000016	0.000050	0.000050	0.000050	0.000050
Chromium (Cr)	mg/L	<0.003	<0.003	<0.003	-	<0.003	<0.003	<0.003	<0.003	<0.003	<0.003	<0.003	-	<0.003	<0.003	<0.003	<0.003	<0.003	<0.003	<0.003	-	<0.003	<0.003	<0.003	<0.003
Cobalt (Co)	mg/L	<0.0005	<0.0005	<0.0005	-	<0.0005	<0.0005	<0.0005	<0.0005	<0.0005	<0.0005	<0.0005	-	<0.0005	<0.0005	<0.0005	<0.0005	0.00025	0.00080	0.00030	0.00014	0.00025	0.00025	0.00025	0.00064
Copper (Cu)	mg/L	0.00060	0.0030	0.0011	0.00052	0.0010	0.0010	0.0010	0.0024	0.00050	0.0010	0.00092	0.00016	0.0010	0.0010	0.0010	0.0010	0.0010	0.0050	0.0035	0.00090	0.0030	0.0033	0.0040	0.0050
Iron (Fe)	mg/L	0.095	0.41	0.22	0.085	0.15	0.21	0.28	0.36	0.0050	0.15	0.036	0.035	0.0050	0.025	0.052	0.090	0.080	0.71	0.28	0.16	0.15	0.23	0.36	0.54
Lead (Pb)	mg/L	0.000050	0.0030	0.00050	0.00049	0.00050	0.00050	0.00050	0.00050	0.000050	0.00050	0.00049	0.00019	0.00050	0.00050	0.00050	0.00050	0.00010	0.00050	0.00043	0.00014	0.00050	0.00050	0.00050	0.00050
Manganese (Mn)	mg/L	0.012	0.11	0.039	0.022	0.024	0.034	0.047	0.071	0.0040	0.13	0.041	0.036	0.016	0.028	0.053	0.116	0.020	0.093	0.031	0.029	0.060	0.019	0.044	0.088
Mercury (Hg)	mg/L	0.0000095	0.000050	0.000040	0.000020	0.000050	0.000050	0.000050	0.000050	0.0000095	0.000050	0.000038	0.000021	0.000050	0.000050	0.000050	0.000050	0.0000095	0.000050	0.000041	0.000018	0.000050	0.000050	0.000050	0.000050
Molybdenum (Mo)	mg/L	<0.002	<0.002	<0.002	-	<0.002	<0.002	<0.002	<0.002	<0.002	<0.002	<0.002	-	<0.002	<0.002	<0.002	<0.002	<0.002	<0.002	<0.002	-	<0.002	<0.002	<0.002	<0.002
Nickel (Ni)	mg/L	<0.003	<0.003	<0.003	-	<0.003	<0.003	<0.003	<0.003	<0.003	<0.003	<0.003	-	<0.003	<0.003	<0.003	<0.003	<0.003	<0.003	<0.003	-	<0.003	<0.003	<0.003	<0.003
Selenium (Se)	mg/L	0.000050	0.0020	0.0016	0.00080	0.0020	0.0020	0.0020	0.0020	0.000050	0.0020	0.0015	0.00082	0.0020	0.0020	0.0020	0.0020	0.000050	0.0020	0.0016	0.00081	0.0020	0.0020	0.0020	0.0020
Silver (Ag)	mg/L	0.0000050	0.00020	0.000045	0.000034	0.000050	0.000050	0.000050	0.000050	0.0000050	0.000050	0.000040	0.000019	0.000050	0.000050	0.000050	0.000050	0.0000050	0.000050	0.000040	0.000019	0.000050	0.000050	0.000050	0.000050
Strontium (Sr)	mg/L	0.011	0.021	0.015	0.0020	0.013	0.015	0.015	0.018	0.0080	0.016	0.013	0.0016	0.012	0.013	0.014	0.015	0.014	0.026	0.019	0.0034	0.017	0.019	0.022	0.026
Thallium (Tl)	mg/L	0.0000050	0.00015	0.00012	0.000060	0.00015	0.00015	0.00015	0.00015	0.0000050	0.00015	0.00012	0.000061	0.00015	0.00015	0.00015	0.00015	0.0000050	0.00015	0.00012	0.000059	0.00015	0.00015	0.00015	0.00015
Titanium (Ti)	mg/L	0.0010	0.0030	0.0012	0.00054	0.0010	0.0010	0.0010	0.0026	<0.002	<0.002	<0.002	-	<0.002	<0.002	<0.002	<0.002	0.0010	0.0020	0.0010	0.00019	0.0010	0.0010	0.0010	0.0010
Tungsten (W)	mg/L	<0.01	<0.01	<0.01	-	<0.01	<0.01	<0.01	<0.01	<0.01	<0.01	<0.01	-	<0.01	<0.01	<0.01	<0.01	<0.01	<0.01	<0.01	-	<0.01	<0.01	<0.01	<0.01
Uranium (U)	mg/L	<0.002	<0.002	<0.002	-	<0.002	<0.002	<0.002	<0.002	<0.002	<0.002	<0.002	-	<0.002	<0.002	<0.002	<0.002	<0.002	<0.002	<0.002	-	<0.002	<0.002	<0.002	<0.002

TABLE 1a
STATISTICAL SUMMARY OF UPDATED BASELINE SURFACE WATER QUALITY DATASET - MOLLIE RIVER WATERSHED
CÔTÉ GOLD PROJECT

Parameter	Unit	3D-c - Three Ducks Lakes, near Outlet (n=22)									DEL-LS - Delaney Lake (Lake Station) (n=3)							DEL - Delaney Lake Outflow (n=1)	P-4 - Inflow to Mollie River (n=4)								
		Minimum	Maximum	Average	Standard Deviation	25 th percentile	Median	75 th percentile	95 th percentile	Minimum	Maximum	Average	Standard Deviation	25 th percentile	Median	75 th percentile	95 th percentile	Data ¹	Minimum	Maximum	Average	Standard Deviation	25 th percentile	Median	75 th percentile	95 th percentile	
FIELD PARAMETERS																											
pH	pH units	5.47	7.83	6.95	0.60	6.81	7.14	7.26	7.80	6.26	6.90	6.62	0.27	6.48	6.69	6.80	6.88	5.78	5.59	6.95	6.34	0.49	6.20	6.40	6.54	6.87	
Temperature	degrees Celsius	-1.4	24	9.1	8.8	0.96	5.6	18	22	2.5	22	14	8.2	9.3	16	19	22	8.3	0	17	5.1	7.0	0.38	1.7	6.4	14.9	
Conductivity	µS/cm	20	41	29	6.7	24	25	34	40	25	46	37	8.8	33	40	43	45	14	14	32	23	6.6	19	23	26	31	
Dissolved Oxygen (DO)	mg/L	1.2	17	9.1	3.9	7.5	9.3	11	16	4.4	9.9	7.0	2.2	5.6	6.7	8.3	9.6	12	6.5	13	11	2.5	10	12	13	13	
GENERAL PARAMETERS																											
Lab pH	pH units	6.01	7.06	6.53	0.28	6.32	6.58	6.73	6.90	6.18	6.53	6.30	0.16	6.18	6.18	6.36	6.50	5.70	6.09	6.55	6.32	0.18	6.17	6.31	6.46	6.53	
Alkalinity	mg/L as CaCO ₃	8.0	16	12	2.0	11	12	13	15	7.0	9.0	7.7	0.94	7.0	7.0	8.0	8.8	<5.0	2.5	13	8.6	4.0	6.6	9.5	12	13	
Electrical Conductivity (EC)	µS/cm	34	54	41	4.9	38	40	42	51	25	37	32	5.1	30	34	36	37	21	8.0	49	30	15	22	32	41	47	
Total Dissolved Solids (TDS)	mg/L	10	78	49	16	44	51	60	64	54	58	56	1.6	55	56	57	58	68	54	72	61	7.5	54	59	66	71	
Total Suspended Solids (TSS)	mg/L	0.50	5.0	2.4	1.9	0.50	1.5	5.0	5.0	<10	<10	<10	-	<10	<10	<10	<10	2.0	1.0	5.0	3.5	1.5	3.3	4.0	4.3	4.9	
Total Hardness	mg/L as CaCO ₃	16	25	19	2.2	18	19	21	24	15	20	17	2.1	16	16	18	20	10	14	25	20	4.1	19	21	22	25	
Dissolved Organic Carbon (DOC)	mg/L	8.5	17	13	2.0	12	12	13	16	17	28	21	4.9	17	17	23	27	15	17	26	21	3.5	18	20	23	26	
MAJOR IONS																											
Calcium (Ca)	mg/L	5.1	7.6	6.0	0.67	5.5	5.7	6.4	7.4	4.5	6.0	5.1	0.63	4.7	4.9	5.5	5.9	3.1	4.2	8.0	6.2	1.4	5.7	6.3	6.8	7.7	
Magnesium (Mg)	mg/L	0.86	1.4	1.1	0.13	0.98	1.0	1.2	1.4	0.88	1.2	1.0	0.14	0.92	0.96	1.1	1.2	0.59	0.79	1.3	1.1	0.19	1.1	1.2	1.2	1.3	
Potassium (K)	mg/L	0.31	0.50	0.39	0.048	0.35	0.39	0.43	0.5	0.26	0.31	0.28	0.022	0.27	0.27	0.29	0.31	0.30	0.23	0.50	0.36	0.095	0.32	0.37	0.41	0.48	
Sodium (Na)	mg/L	0.72	1.1	0.88	0.12	0.79	0.86	0.95	1.1	0.67	0.85	0.74	0.077	0.69	0.71	0.78	0.84	0.55	0.71	1.0	0.84	0.10	0.79	0.82	0.87	0.97	
Chloride (Cl)	mg/L	0.34	0.99	0.56	0.18	0.43	0.54	0.59	0.9	0.25	0.52	0.34	0.13	0.25	0.25	0.39	0.49	0.22	0.29	0.34	0.31	0.019	0.30	0.31	0.33	0.34	
Fluoride (F)	mg/L	<0.05	<0.05	<0.05	-	<0.05	<0.05	<0.05	<0.05	<0.05	<0.05	<0.05	-	<0.05	<0.05	<0.05	<0.05	<0.05	<0.05	<0.05	<0.05	-	<0.05	<0.05	<0.05	<0.05	
Sulphate (SO ₄)	mg/L	2.320	3.6	2.8	0.32	2.6	2.7	3.0	3.4	1.7	2.6	2.2	0.36	2.0	2.2	2.4	2.6	1.9	1.9	4.0	2.7	0.82	2.1	2.5	3.2	3.8	
METALS																											
Aluminum (Al)	mg/L	0.011	0.101	0.053	0.02	0.042	0.052	0.060	0.090	0.086	0.17	0.13	0.033	0.11	0.14	0.15	0.16	0.12	0.13	0.14	0.13	0.0046	0.13	0.14	0.14	0.14	
Antimony (Sb)	mg/L	<0.003	<0.003	<0.003	-	<0.003	<0.003	<0.003	<0.003	<0.003	<0.003	<0.003	-	<0.003	<0.003	<0.003	<0.003	<0.006	<0.006	<0.006	<0.006	-	<0.006	<0.006	<0.006	<0.006	
Arsenic (As)	mg/L	<0.003	<0.003	<0.003	-	<0.003	<0.003	<0.003	<0.003	<0.003	<0.003	<0.003	-	<0.003	<0.003	<0.003	<0.003	<0.003	<0.003	<0.003	<0.003	-	<0.003	<0.003	<0.003	<0.003	
Barium (Ba)	mg/L	0.0040	0.0060	0.0045	0.0	0.0040	0.0040	0.0050	0.0060	0.0040	0.0060	0.0047	0.00094	0.0040	0.0040	0.0050	0.0058	0.0030	0.0050	0.0070	0.0058	0.00083	0.0050	0.0055	0.0063	0.0069	
Beryllium (Be)	mg/L	<0.001	<0.001	<0.001	-	<0.001	<0.001	<0.001	<0.001	<0.001	<0.001	<0.001	-	<0.001	<0.001	<0.001	<0.001	<0.001	<0.001	<0.001	<0.001	-	<0.001	<0.001	<0.001	<0.001	
Boron (B)	mg/L	<0.01	<0.01	<0.01	-	<0.01	<0.01	<0.01	<0.01	<0.01	<0.01	<0.01	-	<0.01	<0.01	<0.01	<0.01	<0.01	<0.01	<0.01	<0.01	-	<0.01	<0.01	<0.01	<0.01	
Cadmium (Cd)	mg/L	0.000010	0.000050	0.000039	0.00002	0.000020	0.000050	0.000050	0.00010	0.000010	0.000050	0.000030	0.000016	0.000020	0.000030	0.000040	0.000048	<0.00002	0.000010	0.000050	0.000040	0.000017	0.000040	0.000050	0.000050	0.000050	
Chromium (Cr)	mg/L	<0.003	<0.003	<0.003	-	<0.003	<0.003	<0.003	<0.003	<0.003	<0.003	<0.003	-	<0.003	<0.003	<0.003	<0.003	<0.003	<0.003	<0.003	<0.003	-	<0.003	<0.003	<0.003	<0.003	
Cobalt (Co)	mg/L	<0.0005	<0.0005	<0.0005	-	<0.0005	<0.0005	<0.0005	<0.0005	<0.0005	<0.0005	<0.0005	-	<0.0005	<0.0005	<0.0005	<0.0005	<0.0005	<0.0005	<0.0005	<0.0005	-	<0.0005	<0.0005	<0.0005	<0.0005	
Copper (Cu)	mg/L	0.00090	0.0012	0.0010	0.000058	0.0010	0.0010	0.0010	0.0011	0.00070	0.0010	0.00083	0.00012	0.00075	0.00080	0.00090	0.00098	0.00090	0.00090	0.0010	0.00098	0.000043	0.00098	0.0010	0.0010	0.0010	
Iron (Fe)	mg/L	0.084	0.27	0.14	0.052	0.098	0.12	0.18	0.23	0.11	0.57	0.30	0.19	0.17	0.23	0.40	0.54	0.28	0.24	0.71	0.41	0.19	0.24	0.35	0.53	0.67	
Lead (Pb)	mg/L	0.000050	0.00050	0.00040	0.00	0.00035	0.00050	0.00050	0.00050	0.00030	0.00060	0.00047	0.00012	0.00040	0.00050	0.00055	0.00059	0.00030	0.00030	0.00050	0.00045	0.000087	0.00045	0.00050	0.00050	0.00050	
Manganese (Mn)	mg/L	0.0090	0.057	0.020	0.013	0.012	0.013	0.022	0.045	0.010	0.045	0.023	0.015	0.013	0.015	0.030	0.042	0.024	0.021	0.080	0.040	0.024	0.024	0.029	0.045	0.073	
Mercury (Hg)	mg/L	0.0000095	0.000050	0.000039	0.000020	0.000050	0.000050	0.000050	0.000050	0.0000095	0.000050	0.000022	0.000020	0.0000086	0.000016	0.000033	0.000047	0.0000099	0.0000050	0.000039	0.000019	0.000039	0.000039	0.000050	0.000050	0.000050	
Molybdenum (Mo)	mg/L	<0.002	<0.002	<0.002	-	<0.002	<0.002	<0.002	<0.002	<0.002	<0.002	<0.002	-	<0.002	<0.002	<0.002	<0.002	<0.002	<0.002	<0.002	<0.002	-	<0.002	<0.002	<0.002	<0.002	
Nickel (Ni)	mg/L	<0.003	<0.003	<0.003	-	<0.003	<0.003	<0.003	<0.003	<0.003	<0.003	<0.003	-	<0.003	<0.003	<0.003	<0.003	<0.003	<0.003	<0.003	<0.003	-	<0.003	<0.003	<0.003	<0.003	
Selenium (Se)	mg/L	0.000050	0.0020	0.0015	0.00085	0.0007	0.0020	0.0020	0.0020	0.000050	0.0020	0.00072	0.00091	0.000075	0.00010	0.0011	0.0018	<0.0001	0.000050	0.0020	0.0015	0.00084	0.0015	0.0020	0.0020	0.0020	
Silver (Ag)	mg/L	0.0000050	0.000050	0.000038	0.000020	0.000016	0.000050	0.000050	0.000050	<0.00001	<0.000016	<0.00001	-	<0.00001	<0.00001	<0.00001	<0.00001	<0.00001	0.0000050	0.000050	0.000039	0.000019	0.000039	0.000050	0.000050	0.000050	
Strontium (Sr)	mg/L	0.0090	0.017	0.013	0.0018	0.011	0.013	0.014	0.015	0.010	0.013	0.012	0.0014	0.012	0.013	0.013	0.013	0.0070	0.0090	0.019	0.015	0.0041	0.013	0.017	0.019	0.019	
Thallium (Tl)	mg/L	0.0000050	0.00015	0.00011	0.0001	0.00004	0.00015	0.00015	0.00015	0.0000050	0.00015	0.000053	0.000068	0.0000050	0.0000050	0.000078	0.000136	<0.00001	0.0000050	0.00015	0.00011	0.000063	0.00011	0.00015	0.00015	0.00015	
Titanium (Ti)	mg/L	<0.002	<0.002	<0.002	-	<0.002	<0.002	<0.002	<0.002	0.0010	0.0020	0.0013	0.00047	0.0010	0.0010	0.0015	0.0019	<0.002	0.0010	0.0030	0.0020	0.0010	0.0010	0.0020	0.0030	0.0030	
Tungsten (W)	mg/L	<0.01	<0.01	<0.01	-	<0.01	<0.01	&																			

TABLE 1a
STATISTICAL SUMMARY OF UPDATED BASELINE SURFACE WATER QUALITY DATASET - MOLLIE RIVER WATERSHED
CÔTÉ GOLD PROJECT

Parameter	Unit	DIV-LS - Dividing Lake (Lake Station) (n=8)								DIV - Dividing Lake Outflow (n=1)
		Minimum	Maximum	Average	Standard Deviation	25 th percentile	Median	75 th percentile	95 th percentile	Data ¹
FIELD PARAMETERS										
pH	pH units	6.35	7.54	7.04	0.35	6.83	7.13	7.23	7.50	6.80
Temperature	degrees Celsius	3.6	22	8.6	6.4	4.1	4.9	11.0	19.9	5.5
Conductivity	µS/cm	43	150	92	33	71	93	108	139	40
Dissolved Oxygen (DO)	mg/L	0.010	13	7.7	4.8	5.0	10	11	13	11
GENERAL PARAMETERS										
Lab pH	pH units	6.28	7.57	6.96	0.40	6.77	6.87	7.25	7.50	6.77
Alkalinity	mg/L as CaCO ₃	11	41	26	10	17	30	34	39	18
Electrical Conductivity (EC)	µS/cm	44	115	78	25	56	78	96	113	64
Total Dissolved Solids (TDS)	mg/L	42	84	64	14	56	64	73	83	82
Total Suspended Solids (TSS)	mg/L	1.0	5.0	4.0	1.7	4.0	5.0	5.0	5.0	0.50
Total Hardness	mg/L as CaCO ₃	19	54	34	11	28	33	39	50	0.00033
Dissolved Organic Carbon (DOC)	mg/L	8.5	13	11	1.6	8.7	11	12	13	11
MAJOR IONS										
Calcium (Ca)	mg/L	5.8	17	10	3.4	8.6	10	12	16	9.0
Magnesium (Mg)	mg/L	1.1	3.0	1.9	0.60	1.6	1.8	2.2	2.8	1.6
Potassium (K)	mg/L	0.36	0.66	0.49	0.097	0.45	0.50	0.53	0.64	0.42
Sodium (Na)	mg/L	1.1	3.2	2.0	0.67	1.6	2.1	2.5	3.0	1.8
Chloride (Cl)	mg/L	1.3	5.8	3.5	1.6	2.1	3.4	4.9	5.7	2.6
Fluoride (F)	mg/L	<0.05	<0.05	<0.05	-	<0.05	<0.05	<0.05	<0.05	0.025
Sulphate (SO ₄)	mg/L	2.4	4.1	3.3	0.56	3.0	3.3	3.7	4.0	3.1
METALS										
Aluminum (Al)	mg/L	0.017	0.087	0.049	0.028	0.022	0.041	0.081	0.087	0.060
Antimony (Sb)	mg/L	0.0015	0.0030	0.0019	0.00065	0.0015	0.0015	0.0019	0.0030	0.0030
Arsenic (As)	mg/L	<0.003	<0.003	<0.003	-	<0.003	<0.003	<0.003	<0.003	0.0015
Barium (Ba)	mg/L	0.0010	0.0050	0.0036	0.0011	0.0038	0.0040	0.0040	0.0047	0.0040
Beryllium (Be)	mg/L	<0.001	<0.001	<0.001	-	<0.001	<0.001	<0.001	<0.001	0.00050
Boron (B)	mg/L	<0.01	<0.01	<0.01	-	<0.01	<0.01	<0.01	<0.01	0.0050
Cadmium (Cd)	mg/L	0.000010	0.000050	0.000020	0.000017	0.000010	0.000010	0.000020	0.000050	0.000010
Chromium (Cr)	mg/L	<0.003	<0.003	<0.003	-	<0.003	<0.003	<0.003	<0.003	0.0015
Cobalt (Co)	mg/L	<0.0005	<0.0005	<0.0005	-	<0.0005	<0.0005	<0.0005	<0.0005	0.00025
Copper (Cu)	mg/L	0.00060	0.0011	0.00091	0.00019	0.00083	0.0010	0.0010	0.0011	0.00090
Iron (Fe)	mg/L	0.010	0.13	0.074	0.046	0.035	0.080	0.12	0.12	0.14
Lead (Pb)	mg/L	0.000050	0.00050	0.00018	0.00019	0.000050	0.000075	0.00020	0.00050	0.00010
Manganese (Mn)	mg/L	0.0080	0.37	0.10	0.12	0.024	0.037	0.15	0.31	0.020
Mercury (Hg)	mg/L	0.0000095	0.000050	0.000014	0.000021	0.0000095	0.0000025	0.000017	0.000050	0.0000079
Molybdenum (Mo)	mg/L	0.000050	0.0010	0.00076	0.00041	0.00076	0.0010	0.0010	0.0010	0.0010
Nickel (Ni)	mg/L	<0.003	<0.003	<0.003	-	<0.003	<0.003	<0.003	<0.003	0.0015
Selenium (Se)	mg/L	0.000050	0.0020	0.00054	0.00084	0.000050	0.000050	0.00054	0.00200	0.000050
Silver (Ag)	mg/L	0.0000050	0.000050	0.000016	0.000019	0.0000050	0.0000050	0.000016	0.000050	0.0000050
Strontium (Sr)	mg/L	0.011	0.020	0.016	0.0035	0.013	0.018	0.019	0.020	0.015
Thallium (Tl)	mg/L	0.0000050	0.00015	0.000078	0.000073	0.0000050	0.000078	0.00015	0.00015	0.0000050
Titanium (Ti)	mg/L	<0.002	<0.002	<0.002	-	<0.002	<0.002	<0.002	<0.002	0.0010
Tungsten (W)	mg/L	<0.01	<0.01	<0.01	-	<0.01	<0.01	<0.01	<0.01	0.0050
Uranium (U)	mg/L	<0.002	<0.002	<0.002	-	<0.002	<0.002	<0.002	<0.002	0.0010
Vanadium (V)	mg/L	<0.002	<0.002	<0.002	-	<0.002	<0.002	<0.002	<0.002	0.0010
Zinc (Zn)	mg/L	0.0025	0.031	0.0073	0.0092	0.0025	0.0025	0.0068	0.0233	0.0025
Zirconium (Zr)	mg/L	<0.004	<0.004	<0.004	-	<0.004	<0.004	<0.004	<0.004	0.0020
OTHER PARAMETERS										
Total Cyanide	mg/L	0.0010	0.0010	0.0010	0	0.0010	0.0010	0.0010	0.0010	0.0010
Total Ammonia (NH ₃ + NH ₄)	mg/L as N	0.010	0.040	0.016	0.011	0.010	0.010	0.015	0.037	0.030
Un-ionized Ammonia (NH ₃)	mg/L	0.0000026	0.000076	0.000032	0.000020	0.000023	0.000030	0.000039	0.000000	0.000025
Total Phosphorus (P)	mg/L	0.010	0.021	0.012	0.0038	0.010	0.010	0.011	0.019	0.022

Notes:
 Values with the less than sign ("<") indicate concentrations below the laboratory method detection limit.
 For the purposes of statistical calculations, values less than the laboratory detection limit were assumed to be equal to one-half the detection limit.
 Dashes ("-") indicate the statistic was not calculated.
⁽¹⁾ For sample locations where n=1, statistics were not calculated.

TABLE 2a
STATISTICAL SUMMARY OF UPDATED BASELINE SURFACE WATER QUALITY DATASET - MESOMIKENDA LAKE WATERSHED
CÔTÉ GOLD PROJECT

Parameter	Unit	LCM - Little Clam Lake Outlet (n=22)								P-3 - Inflow to Bagsverd Lake (n=6)								P-6 - Inflow to Bagsverd Lake (n=24)							
		Minimum	Maximum	Average	Standard Deviation	25 th percentile	Median	75 th percentile	95 th percentile	Minimum	Maximum	Average	Standard Deviation	25 th percentile	Median	75 th percentile	95 th percentile	Minimum	Maximum	Average	Standard Deviation	25 th percentile	Median	75 th percentile	95 th percentile
FIELD PARAMETERS																									
pH	pH units	4.23	7.58	6.41	0.82	6.07	6.51	6.94	7.50	5.18	6.65	6.11	0.57	5.68	6.38	6.57	6.64	5.73	7.63	6.73	0.42	6.50	6.84	7.00	7.20
Temperature	degrees Celsius	-1.5	22	8.4	8.3	0.10	6.4	17	21	0.90	15	6.6	5.8	1.4	4.4	12	15	-0.20	25	9.0	8.2	0.95	6.4	16	20
Conductivity	µS/cm	13	42	27	7.9	21	27	33	42	17	34	24	5.6	20	24	27	32	0.50	94	45	22	29	39	58	84
Dissolved Oxygen (DO)	mg/L	2.6	16	7.3	3.5	4.4	6.9	8.6	13.2	3.1	17	8.2	4.6	4.8	7.2	9.8	15.3	0.87	12	5.7	3.6	2.9	5.1	9.3	11.3
GENERAL PARAMETERS																									
Lab pH	pH units	5.72	6.96	6.32	0.34	6.10	6.29	6.55	6.80	5.88	6.36	6.19	0.15	6.16	6.21	6.29	6.30	6.16	7.40	6.69	0.28	6.54	6.66	6.83	7.10
Alkalinity	mg/L as CaCO ₃	<5	21	11	3.4	9.0	10	13	14	5.0	12	8.2	2.5	7.0	7.0	10	12	9.0	46	26	11	18	25	36	43
Electrical Conductivity (EC)	µS/cm	25	46	37	5.3	34	36	41	46	27	45	37	6.2	34	36	42	45	34	100	64	19	50	60	79	100
Total Dissolved Solids (TDS)	mg/L	26	94	48	19	35	44	48	93	38	74	57	14	44	58	69	74	32	120	64	17	56	62	69	92
Total Suspended Solids (TSS)	mg/L	<1	6.0	2.2	2.1	0.50	0.50	5.0	5.0	0.50	3.0	1.9	0.93	1.3	2.0	2.8	3.0	0.50	20	2.1	4.3	0.50	0.50	1.3	9.6
Total Hardness	mg/L as CaCO ₃	10.9	28	18	4.3	16	17	19	27	13	22	18	3.1	17	18	20	22	16	53	31	9	24	30	35	45
Dissolved Organic Carbon (DOC)	mg/L	7.5	34	14	6.5	9.6	11	14	27	12	23	17	3.7	15	16	18	22	8.6	16	12	1.9	11	12	13	15
MAJOR IONS																									
Calcium (Ca)	mg/L	3.6	10	6.0	1.5	5.2	5.5	6.3	9.3	4.2	7.4	6.0	1.0	5.7	6.1	6.7	7.3	5.1	16	9.4	2.8	7.2	9.2	11	14
Magnesium (Mg)	mg/L	0.47	1.1	0.72	0.14	0.63	0.69	0.82	0.98	0.55	0.94	0.75	0.13	0.68	0.75	0.84	0.92	0.9	3	1.8	0.51	1.5	1.7	2.2	2.5
Potassium (K)	mg/L	<0.05	0.55	0.26	0.13	0.16	0.27	0.32	0.52	0.15	0.43	0.31	0.090	0.28	0.32	0.37	0.42	0.025	0.41	0.20	0.10	0.13	0.20	0.26	0.36
Sodium (Na)	mg/L	0.63	0.89	0.73	0.069	0.68	0.71	0.77	0.85	0.67	1.0	0.83	0.12	0.75	0.82	0.9	1.0	0.69	2.5	1.0	0.34	0.85	0.97	1.1	1.3
Chloride (Cl)	mg/L	0.12	0.43	0.30	0.068	0.27	0.31	0.35	0.41	0.18	0.40	0.30	0.067	0.28	0.30	0.33	0.39	0.11	0.64	0.34	0.14	0.24	0.31	0.42	0.63
Fluoride (F)	mg/L	<0.05	<0.05	<0.05	-	<0.05	<0.05	<0.05	<0.05	<0.050	<0.050	<0.05	-	<0.05	<0.05	<0.05	<0.05	<0.050	<0.050	<0.05	-	<0.05	<0.05	<0.05	<0.05
Sulphate (SO ₄)	mg/L	0.16	4.1	2.7	1.1	2.5	3.0	3.3	3.7	1.9	4.9	3.4	0.96	2.9	3.3	4.0	4.7	1.0	4.8	2.6	1.3	1.4	3.0	3.6	4.7
METALS																									
Aluminum (Al)	mg/L	0.016	0.12	0.056	0.028	0.034	0.051	0.066	0.108	0.10	0.16	0.13	0.025	0.11	0.14	0.16	0.16	0.0090	0.17	0.057	0.039	0.025	0.051	0.090	0.12
Antimony (Sb)	mg/L	<0.0060	<0.0060	<0.0060	-	<0.0060	<0.0060	<0.0060	<0.0060	<0.0060	<0.0060	<0.0060	-	<0.0060	<0.0060	<0.0060	<0.0060	<0.0060	<0.0060	<0.0060	-	<0.0060	<0.0060	<0.0060	<0.0060
Arsenic (As)	mg/L	<0.0030	<0.0030	<0.0030	-	<0.0030	<0.0030	<0.0030	<0.0030	<0.0030	<0.0030	<0.0030	-	<0.0030	<0.0030	<0.0030	<0.0030	<0.0030	<0.0030	<0.0030	-	<0.0030	<0.0030	<0.0030	<0.0030
Barium (Ba)	mg/L	0.0020	0.0080	0.0045	0.0014	0.0040	0.0040	0.0050	0.0070	0.0040	0.0070	0.0050	0.0012	0.0040	0.0045	0.0058	0.0068	0.0010	0.23	0.014	0.045	0.030	0.030	0.0050	0.011
Beryllium (Be)	mg/L	<0.0010	<0.0010	<0.0010	-	<0.0010	<0.0010	<0.0010	<0.0010	<0.0010	<0.0010	<0.0010	-	<0.0010	<0.0010	<0.0010	<0.0010	<0.0010	<0.0010	<0.0010	-	<0.0010	<0.0010	<0.0010	<0.0010
Boron (B)	mg/L	<0.01	<0.01	<0.01	-	<0.01	<0.01	<0.01	<0.01	<0.01	<0.01	<0.01	-	<0.01	<0.01	<0.01	<0.01	<0.01	<0.01	<0.01	-	<0.01	<0.01	<0.01	<0.01
Cadmium (Cd)	mg/L	<0.00002	0.000050	0.000037	0.000019	0.000010	0.000050	0.000050	0.000050	<0.000020	0.000050	0.000035	0.000018	0.000018	0.000045	0.000050	0.000050	<0.000020	<0.00010	0.000038	0.000018	0.000010	0.000050	0.000050	0.000050
Chromium (Cr)	mg/L	<0.003	<0.003	<0.003	-	<0.003	<0.003	<0.003	<0.003	<0.003	<0.003	<0.003	-	<0.003	<0.003	<0.003	<0.003	<0.003	<0.003	<0.003	-	<0.003	<0.003	<0.003	<0.003
Cobalt (Co)	mg/L	<0.00050	0.0011	0.00036	0.00025	0.00025	0.00025	0.00025	0.00090	<0.0005	<0.0005	<0.0005	-	<0.0005	<0.0005	<0.0005	<0.0005	<0.00050	0.00090	0.00032	0.00020	0.00025	0.00025	0.00087	
Copper (Cu)	mg/L	0.00050	0.0010	0.00092	0.00016	0.0010	0.0010	0.0010	0.0010	0.00060	<0.0020	0.00087	0.00016	0.00075	0.00095	0.0010	0.0010	0.00030	0.0010	0.00091	0.00019	0.0010	0.0010	0.0010	0.0010
Iron (Fe)	mg/L	0.020	0.46	0.14	0.013	0.045	0.086	0.17	0.43	0.093	0.33	0.17	0.074	0.14	0.15	0.15	0.28	0.043	2.7	0.45	0.097	0.17	0.36	1.8	
Lead (Pb)	mg/L	0.000050	0.00050	0.00042	0.00014	0.00043	0.00050	0.00050	0.00050	0.00020	<0.001	0.00037	0.00014	0.00023	0.00040	0.00050	0.00050	<0.00010	<0.0010	0.00037	0.00020	0.000050	0.00050	0.00050	0.00050
Manganese (Mn)	mg/L	0.0030	0.15	0.038	0.047	0.0080	0.013	0.055	0.15	0.020	0.064	0.028	0.020	0.014	0.027	0.037	0.058	0.0030	2.8	0.41	0.74	0.017	0.052	0.21	1.8
Mercury (Hg)	mg/L	0.0000095	0.000050	0.000036	0.000022	0.000048	0.000050	0.000050	0.000050	0.0000095	<0.00010	0.000034	0.000023	0.000013	0.000050	0.000050	0.000050	0.0000095	<0.0001	0.000036	0.000022	0.000073	0.000050	0.000050	0.000050
Molybdenum (Mo)	mg/L	<0.0020	<0.0020	<0.0020	-	<0.0020	<0.0020	<0.0020	<0.0020	<0.0020	<0.0020	<0.0020	-	<0.0020	<0.0020	<0.0020	<0.0020	<0.0020	<0.0020	<0.0020	-	<0.0020	<0.0020	<0.0020	<0.0020
Nickel (Ni)	mg/L	<0.0030	<0.0030	<0.0030	-	<0.0030	<0.0030	<0.0030	<0.0030	<0.0030	<0.0030	<0.0030	-	<0.0030	<0.0030	<0.0030	<0.0030	<0.0030	<0.0030	<0.0030	-	<0.0030	<0.0030	<0.0030	<0.0030
Selenium (Se)	mg/L	<0.00001	<0.004	0.0014	0.00091	0.000050	0.0020	0.0020	0.0020	0.000050	<0.0040	0.0011	0.00094	0.00011	0.0012	0.0020	0.0020	<0.00010	<0.0040	0.0014	0.00089	0.000050	0.0020	0.0020	0.0020
Silver (Ag)	mg/L	<0.00001	<0.00010	0.000036	0.000021	0.0000050	0.000050	0.000050	0.000050	<0.000010	<0.00010	0.000028	0.000023	0.0000050	0.000028	0.000050	0.000050	<0.000010	<0.00010	0.000037	0.000020	0.000088	0.000050	0.000050	0.000050
Strontium (Sr)	mg/L	0.0080	0.030	0.014	0.0043	0.012	0.013	0.016	0.018	0.010	0.017	0.014	0.0024	0.013	0.014	0.016	0.017	0.011	0.034	0.021	0.0064	0.017	0.022	0.025	0.033
Thallium (Tl)	mg/L	<0.000010	<0.0003	0.00010	0.000068	0.0000050	0.00015	0.00015	0.00015	<0.00001	<0.0003	0.000078	0.000073	0.0000050	0.000078	0.00015	0.00015	<0.000010	<0.00030	0.00011	0.000066	0.0000050	0.00015	0.00015	0.00015
Titanium (Ti)	mg/L	<0.0020	<0.0020	<0.0020	-	<0.0020	<0.0020	<0.0020	<0.0020	<0.0020	<0.0020	<0.0020	-	<0.0020	<0.0020	<0.0020	<0.0020	<0.0020	<0.0020	<0.0020	-	<0.0020	<0.0020	<0.0020	<0.0020
Tungsten (W)	mg/L	<0.010	<0.010	<0.010	-	<0.010	<0.010	<0.010	<0.010	<0.01	<0.010	<0.010	-	<0.010	<0.010	<0.010	<0.010	<0.010	<0.010	<0.010	-	<0.010	<0.010	<0.010	<0.010
Uranium (U)	mg/L	<0.0020	<0.0020	<0.0020	-	<0.0020	<0.0020																		

TABLE 2a
STATISTICAL SUMMARY OF UPDATED BASELINE SURFACE WATER QUALITY DATASET - MESOMIKENDA LAKE WATERSHED
CÔTÉ GOLD PROJECT

Parameter	Unit	SL - Schist Lake Outflow (n=26)								BAG-LS1 - Bagsverd Lake (Lake Station) (n=10)								BPD - Bagsverd Creek, near Bagsverd Lake Outflow (n=23)							
		Minimum	Maximum	Average	Standard Deviation	25 th percentile	Median	75 th percentile	95 th percentile	Minimum	Maximum	Average	Standard Deviation	25 th percentile	Median	75 th percentile	95 th percentile	Minimum	Maximum	Average	Standard Deviation	25 th percentile	Median	75 th percentile	95 th percentile
FIELD PARAMETERS																									
pH	pH units	5.83	7.52	7.01	0.38	6.93	7.08	7.24	7.40	6.43	7.95	7.22	0.46	7.10	7.20	7.46	7.90	6.13	7.77	7.12	0.39	7.09	7.15	7.34	7.50
Temperature	degrees Celsius	-1.2	22	8.2	8.1	1.0	3.8	15	21	1.0	22	12	6.1	9.2	11	15	21	-0.44	24	9.7	8.4	1.5	8.0	18	22
Conductivity	µS/cm	28	57	40	8.1	35	39	43	55	50	109	66	22	53	58	64	109	23	58	41	10	34	37	50	56
Dissolved Oxygen (DO)	mg/L	4.7	15	9.4	2.7	7.8	9.3	11.3	14.4	3.0	12	8.1	3.1	5.4	9.5	10	11	5.6	16	10.2	2.5	8.2	10.2	12	14
GENERAL PARAMETERS																									
Lab pH	pH units	6.20	7.28	6.79	0.27	6.64	6.82	6.95	7.20	6.31	7.15	6.78	0.28	6.55	6.78	7.05	7.10	6.15	7.34	6.77	0.27	6.68	6.76	6.94	7.20
Alkalinity	mg/L as CaCO ₃	13	29	24	3.5	22	24	26	29	17	25	20	2.4	18	20	21	24	17	26	21	2.7	20	22	24	25
Electrical Conductivity (EC)	µS/cm	51	76	60	6.6	56	58	64	73	48	62	55	4.2	53	57	58	61	48	68	56	5.4	53	56	58	67
Total Dissolved Solids (TDS)	mg/L	22	62	47	10	44	50	52	58	28	58	41	10.0	35	40	50	56	36	80	51	10	44	50	58	62
Total Suspended Solids (TSS)	mg/L	<1	13	2.9	2.8	0.50	2.5	5.0	5.0	1.0	5.0	4.3	1.4	5.0	5.0	5.0	5	0.50	5.0	2.1	2.0	0.50	1.0	4.5	5.0
Total Hardness	mg/L as CaCO ₃	23	36	28	2.9	26	28	30	33	24	31	26	1.9	25	26	26	29	23.5	33	26	6.2	25	27	29	31
Dissolved Organic Carbon (DOC)	mg/L	7.5	14	9.8	1.5	8.6	9.6	10	12	7.7	12	9.6	1.2	8.9	9.2	10	12	6.7	12	9.2	1.2	8.3	8.9	10	11
MAJOR IONS																									
Calcium (Ca)	mg/L	7.4	11	9.1	0.91	8.4	8.9	9.6	10.5	7.6	10	8.4	0.61	8.0	8.3	8.5	9.4	7.6	11	8.8	0.84	8.0	8.8	9.5	10
Magnesium (Mg)	mg/L	1.1	1.8	1.3	0.15	1.2	1.3	1.4	1.6	1.1	1.4	1.2	0.083	1.2	1.2	1.2	1.4	1.1	1.6	1.3	0.14	1.2	1.3	1.5	1.5
Potassium (K)	mg/L	0.21	0.44	0.30	0.054	0.26	0.29	0.33	0.38	0.25	0.33	0.28	0.028	0.26	0.28	0.30	0.33	0.19	0.36	0.28	0.041	0.26	0.28	0.32	0.35
Sodium (Na)	mg/L	0.62	0.86	0.71	0.058	0.66	0.72	0.74	0.81	0.66	0.77	0.70	0.033	0.67	0.69	0.72	0.75	0.62	0.91	0.73	0.070	0.68	0.71	0.77	0.85
Chloride (Cl)	mg/L	0.23	0.41	0.34	0.052	0.30	0.36	0.38	0.40	0.24	0.34	0.30	0.030	0.27	0.30	0.32	0.33	0.21	0.44	0.31	0.061	0.26	0.31	0.35	0.41
Fluoride (F)	mg/L	<0.05	<0.05	<0.05	-	<0.05	<0.05	<0.05	<0.05	0.025	0.050	0.028	0.0075	0.025	0.025	0.025	0.039	<0.05	<0.05	<0.05	-	<0.05	<0.05	<0.05	<0.05
Sulphate (SO ₄)	mg/L	2.6	3.7	3.0	0.28	2.9	3.0	3.1	3.5	2.3	3.5	2.9	0.38	2.6	3.0	3.1	3.4	2.4	3.6	3.0	0.24	2.9	3.0	3.1	3.3
METALS																									
Aluminum (Al)	mg/L	0.0050	0.050	0.020	0.011	0.0105	0.019	0.023	0.041	0.0050	0.053	0.021	0.015	0.0063	0.020	0.027	0.045	0.0060	0.035	0.016	0.0078	0.0090	0.015	0.019	0.030
Antimony (Sb)	mg/L	<0.0060	<0.0060	<0.0060	-	<0.0060	<0.0060	<0.0060	<0.0060	0.0015	0.0030	0.0018	0.00060	0.0015	0.0015	0.0015	0.0030	<0.0060	<0.0060	<0.0060	-	<0.0060	<0.0060	<0.0060	<0.0060
Arsenic (As)	mg/L	<0.0030	<0.0030	<0.0030	-	<0.0030	<0.0030	<0.0030	<0.0030	<0.0030	<0.0030	<0.0030	-	<0.0030	<0.0030	<0.0030	<0.0030	<0.0030	<0.0030	<0.0030	-	<0.0030	<0.0030	<0.0030	<0.0030
Barium (Ba)	mg/L	0.0040	0.010	0.0060	0.0014	0.0050	0.0060	0.0068	0.0080	0.0040	0.0080	0.0053	0.0010	0.0050	0.0050	0.0050	0.0071	0.0040	0.0070	0.0051	0.00068	0.0050	0.0050	0.0050	0.0060
Beryllium (Be)	mg/L	<0.0010	<0.0010	<0.0010	-	<0.0010	<0.0010	<0.0010	<0.0010	<0.0010	<0.0010	<0.0010	-	<0.0010	<0.0010	<0.0010	<0.0010	<0.0010	<0.0010	<0.0010	-	<0.0010	<0.0010	<0.0010	<0.0010
Boron (B)	mg/L	<0.01	<0.01	<0.01	-	<0.01	<0.01	<0.01	<0.01	<0.01	<0.01	<0.01	-	<0.01	<0.01	<0.01	<0.01	<0.01	<0.01	<0.01	-	<0.01	<0.01	<0.01	<0.01
Cadmium (Cd)	mg/L	0.000010	0.000050	0.000039	0.000018	0.000020	0.000050	0.000050	0.000050	0.000010	0.000050	0.000018	0.000016	0.000010	0.000010	0.000010	0.000005	0.000010	0.000050	0.000038	0.000018	0.000010	0.000050	0.000050	0.000050
Chromium (Cr)	mg/L	<0.003	<0.003	<0.003	-	<0.003	<0.003	<0.003	<0.003	<0.003	<0.003	<0.003	-	<0.003	<0.003	<0.003	<0.003	<0.003	<0.003	<0.003	-	<0.003	<0.003	<0.003	<0.003
Cobalt (Co)	mg/L	<0.0005	<0.0005	<0.0005	-	<0.0005	<0.0005	<0.0005	<0.0005	<0.0005	<0.0005	<0.0005	-	<0.0005	<0.0005	<0.0005	<0.0005	<0.0005	<0.0005	<0.0005	-	<0.0005	<0.0005	<0.0005	<0.0005
Copper (Cu)	mg/L	0.00040	0.0010	0.00088	0.00021	0.00078	0.0010	0.0010	0.0010	0.00050	0.0019	0.00087	0.00038	0.00063	0.00080	0.00098	0.0015	0.00020	0.0010	0.00083	0.00026	0.00060	0.0010	0.0010	0.0010
Iron (Fe)	mg/L	0.0050	0.15	0.039	0.034	0.014	0.032	0.043	0.092	0.0050	0.18	0.039	0.058	0.0050	0.0075	0.026	0.16	0.0050	0.090	0.018	0.020	0.0050	0.0050	0.023	0.051
Lead (Pb)	mg/L	0.000050	0.00050	0.00038	0.00020	0.00016	0.00050	0.00050	0.00050	0.000050	0.00050	0.00019	0.00017	0.000050	0.00015	0.00020	0.00050	0.000050	0.00050	0.00037	0.00020	0.000075	0.00050	0.00050	0.00050
Manganese (Mn)	mg/L	0.0060	0.056	0.025	0.013	0.016	0.024	0.030	0.040	0.0040	0.27	0.078	0.078	0.030	0.037	0.067	0.22	0.0090	0.07	0.027	0.014	0.014	0.025	0.033	0.048
Mercury (Hg)	mg/L	0.00000095	0.000050	0.000037	0.000022	0.000040	0.000050	0.000050	0.000050	0.00000095	0.000050	0.000012	0.000019	0.00000095	0.00000095	0.0000063	0.000005	0.00000095	0.000050	0.000035	0.000022	0.000048	0.000050	0.000050	0.000050
Molybdenum (Mo)	mg/L	<0.0020	<0.0020	<0.0020	-	<0.0020	<0.0020	<0.0020	<0.0020	0.000050	0.0010	0.00081	0.00038	0.0010	0.0010	0.0010	0.001	<0.0020	<0.0020	<0.0020	-	<0.0020	<0.0020	<0.0020	<0.0020
Nickel (Ni)	mg/L	<0.0030	<0.0030	<0.0030	-	<0.0030	<0.0030	<0.0030	<0.0030	<0.0030	<0.0030	<0.0030	-	<0.0030	<0.0030	<0.0030	<0.0030	<0.0030	<0.0030	<0.0030	-	<0.0030	<0.0030	<0.0030	<0.0030
Selenium (Se)	mg/L	0.000050	0.0020	0.0015	0.00085	0.0007	0.0020	0.0020	0.0020	0.000050	0.0020	0.00044	0.00078	0.000050	0.000050	0.000050	0.0020	0.000050	0.0020	0.0014	0.00090	0.000050	0.0020	0.0020	0.0020
Silver (Ag)	mg/L	0.0000050	0.000050	0.000038	0.000020	0.000016	0.000050	0.000050	0.000050	0.0000050	0.000050	0.000014	0.000018	0.0000050	0.0000050	0.0000050	0.0000050	0.0000050	0.000050	0.000036	0.000021	0.0000050	0.000050	0.000050	0.000050
Strontium (Sr)	mg/L	0.019	0.030	0.023	0.0027	0.021	0.023	0.025	0.027	0.018	0.021	0.019	0.00083	0.018	0.019	0.020	0.015	0.026	0.020	0.020	0.0027	0.018	0.020	0.022	0.024
Thallium (Tl)	mg/L	0.0000050	0.00015	0.00011	0.000063	0.000060	0.00015	0.00015	0.00015	0.0000050	0.00015	0.000034	0.000058	0.0000050	0.0000050	0.0000050	0.00015	0.0000050	0.00015	0.00011	0.000065	0.000018	0.00015	0.00015	0.00015
Titanium (Ti)	mg/L	<0.0020	<0.0020	<0.0020	-	<0.0020	<0.0020	<0.0020	<0.0020	<0.0020	<0.0020	<0.0020	-	<0.0020	<0.0020	<0.0020	<0.0020	<0.0020	<0.0020	<0.0020	-	<0.0020	<0.0020	<0.0020	<0.0020
Tungsten (W)	mg/L	<0.010	<0.010	<0.010	-	<0.010	<0.010	<0.010	<0.010	<0.010	<0.010	<0.010	-	<0.010	<0.010	<0.010	<0.010	<0.010	<0.010	<0.010	-	<0.010	<0.010	<0.010	<0.010
Uranium (U)	mg/L	<0.0020	<0.0020																						

TABLE 2a
STATISTICAL SUMMARY OF UPDATED BASELINE SURFACE WATER QUALITY DATASET - MESOMIKENDA LAKE WATERSHED
CÔTÉ GOLD PROJECT

Parameter	Unit	NL - Neville Lake (n=12)								MESO-LS7 - Mesomikenda Lake (Lower) (Lake Station) (n=10)								MESO-LS5 - Mesomikenda Lake (Middle) (Lake Station) (n=10)							
		Minimum	Maximum	Average	Standard Deviation	25 th percentile	Median	75 th percentile	95 th percentile	Minimum	Maximum	Average	Standard Deviation	25 th percentile	Median	75 th percentile	95 th percentile	Minimum	Maximum	Average	Standard Deviation	25 th percentile	Median	75 th percentile	95 th percentile
FIELD PARAMETERS																									
pH	pH units	5.90	7.25	6.65	0.43	6.24	6.76	7.02	7.20	6.39	7.73	7.28	0.35	7.25	7.37	7.44	7.60	6.19	7.56	7.16	0.38	7.08	7.25	7.38	7.60
Temperature	degrees Celsius	-1.1	23	7.4	8.6	0.27	4.1	12	23	1.7	21	7.9	6.1	3.9	4.4	10	19	1.5	19	7.8	5.7	4.3	4.7	10	18
Conductivity	µS/cm	3.0	45	28	11	23	28	35	42	127	142	136	5.2	133	139	140	142	74	90	83	5.2	79	84	87	89
Dissolved Oxygen (DO)	mg/L	7.9	18	11	2.6	10.5	11	12	16	5.6	14	10	2.8	7.2	10	12	14	6.9	13	10	1.6	10	10	12	13
GENERAL PARAMETERS																									
Lab pH	pH units	6.05	6.70	6.41	0.19	6.29	6.50	6.54	6.60	6.35	7.68	7.11	0.43	6.81	7.18	7.45	7.70	6.34	7.51	6.92	0.41	6.55	6.99	7.18	7.50
Alkalinity	mg/L as CaCO ₃	5.0	21	13	4.4	11	14	15	20	29	39	33	2.5	31	32	33	37	18	25	22	2.2	22	23	23	24
Electrical Conductivity (EC)	µS/cm	26	59	44	9.4	40	42	49	58	128	146	134	5.8	128	132	138	143	75	94	82	5.4	77	82	83	90
Total Dissolved Solids (TDS)	mg/L	34	62	48	8.2	44	48	53	60	68	104	81	12	70	79	85	101	40	74	53	9.4	47	52	59	68
Total Suspended Solids (TSS)	mg/L	0.50	4.0	1.1	1.0	0.50	0.50	1.3	2.9	0.50	5.0	4.1	1.8	5.0	5.0	5.0	5.0	0.50	5.0	4.1	1.8	5.0	5.0	5.0	5.0
Total Hardness	mg/L as CaCO ₃	13	28	21	4.0	19	20	24	27	37	47	41	3.1	39	41	43	46	25	36	29	2.8	27	28	30	34
Dissolved Organic Carbon (DOC)	mg/L	10	15	12	1.4	11	11	12	14	4.7	6.7	5.9	0.57	5.7	6.0	6.4	6.6	6.0	11	8.1	1.6	7.2	7.5	8.5	11.0
MAJOR IONS																									
Calcium (Ca)	mg/L	3.6	8.4	6.0	1.2	5.5	5.8	6.7	7.8	12	15	13	0.95	12	13	14	14	7.6	11	8.7	0.86	8.1	8.5	8.9	10.2
Magnesium (Mg)	mg/L	0.83	1.8	1.4	0.26	1.3	1.4	1.5	1.8	2.0	2.6	2.2	0.18	2.1	2.1	2.3	2.5	1.5	2.1	1.7	0.17	1.6	1.7	1.8	2.0
Potassium (K)	mg/L	0.21	0.34	0.27	0.041	0.24	0.27	0.30	0.33	0.46	0.54	0.51	0.029	0.48	0.52	0.53	0.54	0.33	0.45	0.38	0.036	0.36	0.38	0.40	0.44
Sodium (Na)	mg/L	0.65	1.0	0.85	0.10	0.80	0.86	0.92	0.98	8.7	9.9	9.1	0.37	8.8	8.9	9.0	9.8	3.6	5.3	4.1	0.49	3.9	4.0	4.3	5.0
Chloride (Cl)	mg/L	0.18	0.46	0.30	0.084	0.24	0.28	0.38	0.42	15	17	16	0.48	15	16	16	16	5.5	8.0	6.5	0.87	5.7	6.1	7.4	7.8
Fluoride (F)	mg/L	<0.05	<0.05	<0.05	-	<0.05	<0.05	<0.05	<0.05	<0.05	<0.05	<0.05	-	<0.05	<0.05	<0.05	<0.05	<0.05	<0.05	<0.05	-	<0.05	<0.05	<0.05	<0.05
Sulphate (SO ₄)	mg/L	2.1	3.7	2.9	0.47	2.7	2.9	3.2	3.6	4.0	4.7	4.3	0.19	4.2	4.3	4.3	4.6	3.3	5.1	3.8	0.56	3.5	3.6	4.0	4.9
METALS																									
Aluminum (Al)	mg/L	0.034	0.097	0.071	0.020	0.061	0.072	0.088	0.096	0.0090	0.033	0.018	0.0075	0.013	0.015	0.022	0.031	nc	0.044	0.034	0.012	0.033	0.036	0.044	0.044
Antimony (Sb)	mg/L	<0.0060	<0.0060	<0.0060	-	<0.0060	<0.0060	<0.0060	<0.0060	0.0015	0.0030	0.0018	0.00060	0.0015	0.0015	0.0015	0.0030	0.0015	0.0030	0.0018	0.00060	0.0015	0.0015	0.0015	0.0030
Arsenic (As)	mg/L	<0.0030	<0.0030	<0.0030	-	<0.0030	<0.0030	<0.0030	<0.0030	<0.0030	<0.0030	<0.0030	-	<0.0030	<0.0030	<0.0030	<0.0030	<0.0030	<0.0030	<0.0030	-	<0.0030	<0.0030	<0.0030	<0.0030
Barium (Ba)	mg/L	0.0030	0.0060	0.0046	0.00076	0.0040	0.0050	0.0050	0.0055	0.0030	0.0040	0.0032	0.00040	0.0030	0.0030	0.0030	0.0040	0.0030	0.0050	0.0034	0.00066	0.0030	0.0030	0.0038	0.0046
Beryllium (Be)	mg/L	<0.0010	<0.0010	<0.0010	-	<0.0010	<0.0010	<0.0010	<0.0010	<0.0010	<0.0010	<0.0010	-	<0.0010	<0.0010	<0.0010	<0.0010	<0.0010	<0.0010	<0.0010	-	<0.0010	<0.0010	<0.0010	<0.0010
Boron (B)	mg/L	<0.01	<0.01	<0.01	-	<0.01	<0.01	<0.01	<0.01	<0.01	<0.01	<0.01	-	<0.01	<0.01	<0.01	<0.01	<0.01	<0.01	<0.01	-	<0.01	<0.01	<0.01	<0.01
Cadmium (Cd)	mg/L	0.000010	0.000050	0.000031	0.000019	0.000010	0.000035	0.000050	0.000050	0.000010	0.000050	0.000018	0.000016	0.000010	0.000010	0.000010	0.000050	0.000010	0.000050	0.000018	0.000016	0.000010	0.000010	0.000010	0.000050
Chromium (Cr)	mg/L	<0.003	<0.003	<0.003	-	<0.003	<0.003	<0.003	<0.003	<0.003	<0.003	<0.003	-	<0.003	<0.003	<0.003	<0.003	<0.003	<0.003	<0.003	-	<0.003	<0.003	<0.003	<0.003
Cobalt (Co)	mg/L	<0.0005	<0.0005	<0.0005	-	<0.0005	<0.0005	<0.0005	<0.0005	<0.0005	<0.0005	<0.0005	-	<0.0005	<0.0005	<0.0005	<0.0005	<0.0005	<0.0005	<0.0005	-	<0.0005	<0.0005	<0.0005	<0.0005
Copper (Cu)	mg/L	0.00060	0.0012	0.00087	0.00020	0.00068	0.0010	0.0010	0.0011	0.00050	0.0013	0.00077	0.00025	0.00060	0.00070	0.00095	0.00117	0.00060	0.0020	0.00088	0.00040	0.00063	0.00075	0.00095	0.00155
Iron (Fe)	mg/L	0.082	0.25	0.17	0.052	0.13	0.16	0.21	0.24	0.0050	0.030	0.0100	0.010	0.0050	0.0050	0.0050	0.0300	0.0050	0.040	0.017	0.011	0.0050	0.020	0.021	0.033
Lead (Pb)	mg/L	0.000050	0.00050	0.00033	0.00019	0.00010	0.00045	0.00050	0.00050	0.000050	0.00050	0.00014	0.00018	0.000050	0.000050	0.000050	0.00050	0.000050	0.050	0.0052	0.015	0.000050	0.000050	0.00048	0.02772
Manganese (Mn)	mg/L	0.010	0.033	0.018	0.0069	0.013	0.017	0.021	0.030	0.0010	0.075	0.014	0.021	0.0020	0.0045	0.016	0.050	0.0010	0.0050	0.0028	0.0017	0.0010	0.0025	0.0048	0.0050
Mercury (Hg)	mg/L	0.0000095	0.000050	0.000027	0.000023	0.000014	0.000030	0.000050	0.000050	0.0000095	0.000050	0.000011	0.000019	0.0000095	0.0000095	0.000024	0.0000500	0.0000095	0.000050	0.000013	0.000019	0.0000095	0.000015	0.000016	0.000050
Molybdenum (Mo)	mg/L	<0.0020	<0.0020	<0.0020	-	<0.0020	<0.0020	<0.0020	<0.0020	0.000050	0.0010	0.00081	0.00038	0.0010	0.0010	0.0010	0.0010	0.000050	0.0010	0.00081	0.00038	0.0010	0.0010	0.0010	0.0010
Nickel (Ni)	mg/L	<0.0030	<0.0030	<0.0030	-	<0.0030	<0.0030	<0.0030	<0.0030	<0.0030	<0.0030	<0.0030	-	<0.0030	<0.0030	<0.0030	<0.0030	<0.0030	<0.0030	<0.0030	-	<0.0030	<0.0030	<0.0030	<0.0030
Selenium (Se)	mg/L	0.000050	0.0020	0.0010	0.00098	0.000050	0.0010	0.0020	0.0020	0.000050	0.0020	0.00050	0.00076	0.000050	0.000050	0.00038	0.00200	0.000050	0.0020	0.00053	0.00076	0.000050	0.000050	0.00060	0.00200
Silver (Ag)	mg/L	0.0000050	0.000050	0.000028	0.000023	0.0000050	0.000028	0.000050	0.000050	0.0000050	0.000050	0.000016	0.000018	0.0000050	0.0000050	0.000018	0.000050	0.0000050	0.000050	0.000017	0.000018	0.0000050	0.0000050	0.000024	0.000050
Strontium (Sr)	mg/L	0.010	0.023	0.016	0.0032	0.015	0.016	0.018	0.021	0.016	0.022	0.020	0.017	0.019	0.020	0.020	0.022	0.014	0.020	0.017	0.0015	0.016	0.016	0.017	0.019
Thallium (Tl)	mg/L	0.0000050	0.00015	0.000078	0.000073	0.0000050	0.000078	0.00015	0.00015	0.0000050	0.00015	0.000063	0.000071	0.0000050	0.0000050	0.00015	0.00015	0.0000050	0.00015	0.000063	0.000071	0.0000050	0.0000050	0.00015	0.00015
Titanium (Ti)	mg/L	0.0010	0.0020	0.0012	0.00037	0.0010	0.0010	0.0010	0.0020	<0.0020	<0.0020	<0.0020	-	<0.0020	<0.0020	<0.0020	<0.0020	<0.0020	<0.0020	<0.0020	-	<0.0020	<0.0020	<0.0020	<0.0020
Tungsten (W)	mg/L	<0.010	<0.010	<0.010	-	<0.010	<0.010	<0.010	<0.010	<0.010	<0.010	<0.010	-	<0.010	<0.010	<0.010	<0.010	<0.010	<0.010	<0.010	-	<0.010	<0.010	<0.010	<0.010
Uranium (U)	mg/L	<0.0020	<0.0020	<0.0020	-	<0.0020																			

TABLE 2a
STATISTICAL SUMMARY OF UPDATED BASELINE SURFACE WATER QUALITY DATASET - MESOMIKENDA LAKE WATERSHED
CÔTÉ GOLD PROJECT

Parameter	Unit	MESO-LS4 - Mesomikenda Lake (Middle) (Lake Station) (n=10)								MESO-LS2 - Mesomikenda Lake (Upper) (Lake Station) (n=10)								MESO-OUT - Mesomikenda Lake Outflow (n=13)							
		Minimum	Maximum	Average	Standard Deviation	25 th percentile	Median	75 th percentile	95 th percentile	Minimum	Maximum	Average	Standard Deviation	25 th percentile	Median	75 th percentile	95 th percentile	Minimum	Maximum	Average	Standard Deviation	25 th percentile	Median	75 th percentile	95 th percentile
FIELD PARAMETERS																									
pH	pH units	6.23	7.67	7.12	0.38	6.96	7.19	7.31	7.60	6.12	7.35	7.00	0.33	6.99	7.08	7.19	7.30	5.28	8.03	7.07	0.70	6.84	7.09	7.53	8.00
Temperature	degrees Celsius	1.6	21	7.8	6.2	4.3	4.6	9.9	19.3	0.31	20	7.7	5.9	4.3	5.0	9.3	18.7	-0.97	22	7.0	7.9	0.93	3.6	10	21
Conductivity	µS/cm	73	87	81	4.8	76	81	85	87	46	65	57	5.9	54	57	62	65	29	59	39	8.8	33	35	46	53
Dissolved Oxygen (DO)	mg/L	4.2	12	10	2.2	9.3	11	11	12	6.8	13	10.1	1.7	9.2	10	11	12	8.5	20	13	3.1	9.9	12	14	18
GENERAL PARAMETERS																									
Lab pH	pH units	6.32	7.50	6.88	0.44	6.43	6.95	7.17	7.50	6.28	7.42	6.78	0.40	6.40	6.74	7.02	7.40	6.18	7.20	6.69	0.24	6.61	6.71	6.76	7.10
Alkalinity	mg/L as CaCO ₃	18	24	22	1.5	21	22	22	24	13	22	18	2.7	17	18	21	22	14	23	19	2.5	18	20	21	22
Electrical Conductivity (EC)	µS/cm	74	85	79	3.5	76	78	82	84	47	62	55	5	52	55	61	62	47	64	55	5.3	50	56	60	63
Total Dissolved Solids (TDS)	mg/L	42	92	64	15	54	62	72	88	26	64	43	11	33	43	50	60	10	90	45	19	34	46	52	73
Total Suspended Solids (TSS)	mg/L	0.50	5.0	4.1	1.8	5.0	5.0	5.0	5.0	0.50	5.0	4.3	1.5	5.0	5.0	5.0	5.0	0.50	4.0	1.0	1.1	0.50	0.50	1.0	3.4
Total Hardness	mg/L as CaCO ₃	26	32	28	1.9	27	28	29	31	20	28	24	2.0	24	24	26	27	22	29	25	2.3	24	24	28	29
Dissolved Organic Carbon (DOC)	mg/L	6.2	9.6	7.9	1.0	7.2	8.1	8.6	9.3	7.3	12	9.0	1.6	7.9	8.4	9.6	12.0	7.8	15	9.9	2.2	8.4	8.9	9.8	14.0
MAJOR IONS																									
Calcium (Ca)	mg/L	7.9	9.7	8.5	0.55	8.1	8.3	8.9	9.4	5.8	8.2	7.2	0.62	6.9	7.1	7.6	8.0	6.5	8.4	7.4	0.65	7.0	7.1	8.2	8.4
Magnesium (Mg)	mg/L	1.5	2.0	1.7	0.12	1.6	1.7	1.8	1.9	1.3	1.8	1.6	0.12	1.6	1.6	1.7	1.7	1.5	2.0	1.7	0.18	1.6	1.6	1.8	2.0
Potassium (K)	mg/L	0.34	0.43	0.39	0.032	0.36	0.39	0.41	0.43	0.27	0.36	0.33	0.026	0.32	0.34	0.35	0.36	0.29	0.42	0.33	0.033	0.31	0.32	0.34	0.39
Sodium (Na)	mg/L	3.3	4.6	4.0	0.33	3.8	3.9	4.2	4.4	0.99	1.6	1.3	0.19	1.3	1.4	1.4	1.5	1.0	1.5	1.3	0.12	1.2	1.3	1.4	1.5
Chloride (Cl)	mg/L	5.0	7.4	6.2	0.73	5.7	6.1	6.7	7.3	0.41	1.6	1.1	0.33	1.1	1.2	1.3	1.5	0.53	1.4	1.0	0.26	0.78	1.1	1.3	1.3
Fluoride (F)	mg/L	<0.05	<0.05	<0.05	-	<0.05	<0.05	<0.05	<0.05	<0.05	<0.05	<0.05	-	<0.05	<0.05	<0.05	<0.05	<0.05	<0.05	<0.05	-	<0.05	<0.05	<0.05	<0.05
Sulphate (SO ₄)	mg/L	3.3	4.2	3.7	0.33	3.4	3.5	4.0	4.2	2.7	3.4	3.1	0.21	3.0	3.2	3.2	3.4	2.8	4.1	3.2	0.30	3.1	3.1	3.2	3.8
METALS																									
Aluminum (Al)	mg/L	0.035	0.089	0.045	0.016	0.036	0.040	0.044	0.073	0.039	0.071	0.052	0.0094	0.044	0.054	0.057	0.066	0.038	0.091	0.057	0.018	0.044	0.048	0.064	0.090
Antimony (Sb)	mg/L	0.0015	0.0030	0.0018	0.00060	0.0015	0.0015	0.0015	0.0030	0.0015	0.0030	0.0018	0.00060	0.0015	0.0015	0.0015	0.0030	<0.0060	<0.0060	<0.0060	-	<0.0060	<0.0060	<0.0060	<0.0060
Arsenic (As)	mg/L	<0.0030	<0.0030	<0.0030	-	<0.0030	<0.0030	<0.0030	<0.0030	<0.0030	<0.0030	<0.0030	-	<0.0030	<0.0030	<0.0030	<0.0030	<0.0030	<0.0030	<0.0030	-	<0.0030	<0.0030	<0.0030	<0.0030
Barium (Ba)	mg/L	0.0030	0.0040	0.0033	0.00046	0.0030	0.0030	0.0038	0.0040	0.0030	0.0040	0.0037	0.00046	0.0033	0.0040	0.0040	0.0040	0.0030	0.0050	0.0041	0.00047	0.0040	0.0040	0.0040	0.0050
Beryllium (Be)	mg/L	<0.0010	<0.0010	<0.0010	-	<0.0010	<0.0010	<0.0010	<0.0010	<0.0010	<0.0010	<0.0010	-	<0.0010	<0.0010	<0.0010	<0.0010	<0.0010	<0.0010	<0.0010	-	<0.0010	<0.0010	<0.0010	<0.0010
Boron (B)	mg/L	<0.01	<0.01	<0.01	-	<0.01	<0.01	<0.01	<0.01	<0.01	<0.01	<0.01	-	<0.01	<0.01	<0.01	<0.01	<0.01	<0.01	<0.01	-	<0.01	<0.01	<0.01	<0.01
Cadmium (Cd)	mg/L	0.000010	0.000050	0.000018	0.000016	0.000010	0.000010	0.000010	0.000050	0.000010	0.000050	0.000018	0.000016	0.000010	0.000010	0.000010	0.000050	0.000010	0.000050	0.000031	0.000019	0.000010	0.000040	0.000050	0.000050
Chromium (Cr)	mg/L	<0.003	<0.003	<0.003	-	<0.003	<0.003	<0.003	<0.003	<0.003	<0.003	<0.003	-	<0.003	<0.003	<0.003	<0.003	<0.003	<0.003	<0.003	-	<0.003	<0.003	<0.003	<0.003
Cobalt (Co)	mg/L	<0.0005	<0.0005	<0.0005	-	<0.0005	<0.0005	<0.0005	<0.0005	<0.0005	<0.0005	<0.0005	-	<0.0005	<0.0005	<0.0005	<0.0005	<0.0005	<0.0005	<0.0005	-	<0.0005	<0.0005	<0.0005	<0.0005
Copper (Cu)	mg/L	0.00050	0.0010	0.00078	0.00017	0.00070	0.00075	0.00095	0.00100	0.00050	0.0013	0.00082	0.00023	0.00070	0.00070	0.0010	0.0012	0.00030	0.0014	0.00087	0.00026	0.00070	0.0010	0.0010	0.0012
Iron (Fe)	mg/L	0.0050	0.070	0.021	0.020	0.0050	0.015	0.026	0.057	0.0050	0.15	0.051	0.043	0.0088	0.051	0.070	0.118	0.0050	0.17	0.073	0.055	0.033	0.053	0.11	0.16
Lead (Pb)	mg/L	0.000050	0.00050	0.00014	0.00018	0.000050	0.000050	0.000050	0.000500	0.000050	0.00050	0.00018	0.000050	0.000050	0.000050	0.000050	0.000088	0.000050	0.00050	0.00028	0.00021	0.000050	0.00030	0.00050	0.00050
Manganese (Mn)	mg/L	0.0010	0.0040	0.0025	0.0012	0.0013	0.0025	0.0038	0.0040	0.0050	0.012	0.0079	0.0019	0.0070	0.0075	0.0088	0.0111	0.0030	0.011	0.0065	0.0025	0.0050	0.0060	0.0080	0.0110
Mercury (Hg)	mg/L	0.00000095	0.000050	0.000012	0.000019	0.00000095	0.00000095	0.000011	0.000050	0.00000095	0.000050	0.000011	0.000019	0.00000095	0.00000095	0.0000037	0.0000500	0.00000095	0.000050	0.000024	0.000024	0.00000095	0.000066	0.000050	0.000050
Molybdenum (Mo)	mg/L	0.000050	0.0010	0.00081	0.00038	0.0010	0.0010	0.0010	0.0010	0.000050	0.0010	0.00081	0.00038	0.0010	0.0010	0.0010	0.0010	<0.0020	<0.0020	<0.0020	-	<0.0020	<0.0020	<0.0020	<0.0020
Nickel (Ni)	mg/L	<0.0030	<0.0030	<0.0030	-	<0.0030	<0.0030	<0.0030	<0.0030	<0.0030	<0.0030	<0.0030	-	<0.0030	<0.0030	<0.0030	<0.0030	<0.0030	<0.0030	<0.0030	-	<0.0030	<0.0030	<0.0030	<0.0030
Selenium (Se)	mg/L	0.000050	0.0020	0.00046	0.00077	0.000050	0.000050	0.00016	0.00200	0.000050	0.0020	0.00044	0.00078	0.000050	0.000050	0.000050	0.002000	0.000050	0.0020	0.00095	0.00097	0.000050	0.000050	0.0020	0.0020
Silver (Ag)	mg/L	0.0000050	0.000050	0.000015	0.000018	0.0000050	0.0000050	0.000010	0.000050	0.0000050	0.000050	0.000016	0.000018	0.0000050	0.0000050	0.000018	0.000050	0.0000050	0.000026	0.000022	0.000022	0.0000050	0.0000050	0.000050	0.000050
Strontium (Sr)	mg/L	0.014	0.021	0.016	0.0018	0.015	0.016	0.017	0.019	0.013	0.017	0.015	0.0012	0.014	0.015	0.016	0.017	0.014	0.021	0.016	0.0018	0.015	0.015	0.016	0.019
Thallium (Tl)	mg/L	0.0000050	0.00015	0.000063	0.000071	0.0000050	0.0000050	0.00015	0.00015	0.0000050	0.00015	0.000063	0.000071	0.0000050	0.0000050	0.00015	0.00015	0.0000050	0.00015	0.000073	0.000071	0.0000050	0.000020	0.00015	0.00015
Titanium (Ti)	mg/L	<0.0020	<0.0020	<0.0020	-	<0.0020	<0.0020	<0.0020	<0.0020	<0.0020	<0.0020	<0.0020	-	<0.0020	<0.0020	<0.0020	<0.0020	0.0010	0.0030	0.0012	0.00053	0.0010	0.0010	0.0010	0.0018
Tungsten (W)	mg/L	<0.010	<0.010	<0.010	-	<0.010	<0.010	<0.010	<0.010	<0.010	<0.010	<0.010	-	<0.010	<0.010	<0.010	<0.010	<0.010	<0.010	<0.010	-	<0.010	<0.010	<0.010	<0.010
Uranium (U)	mg/L	<0.0020																							

TABLE 3a
STATISTICAL SUMMARY OF UPDATED BASELINE GROUNDWATER QUALITY DATASET
CÔTÉ GOLD PROJECT

Parameter	Unit	BH12-1 (n=4)								BH12-2A (n=4)								BH12-2B (n=4)								
		Minimum	Maximum	Average	Standard Deviation	25th percentile	Median	75 th percentile	95 th percentile	Minimum	Maximum	Average	Standard Deviation	25th percentile	Median	75 th percentile	95 th percentile	Minimum	Maximum	Average	Standard Deviation	25th percentile	Median	75 th percentile	95 th percentile	
GENERAL PARAMETERS																										
pH	pH units	7.80	8.00	7.90	0.07	7.80	7.90	7.90	8.00	7.80	8.00	7.90	0.10	7.90	8.00	8.00	8.00	7.90	7.90	7.90	0.01	7.90	7.90	7.90	7.90	7.90
Alkalinity	mg/L as CaCO ₃	110	200	150	34	130	140	160	190	88	92	90	1.8	89	91	92	92	48	66	56	6.6	52	55	59	65	
Electrical Conductivity (EC)	µS/cm	240	420	300	67	270	280	320	400	190	210	200	5.8	190	190	200	200	90	120	110	13	99	110	120	120	
Total Dissolved Solids (TDS)	mg/L	130	250	180	43	150	170	190	230	120	150	130	11	120	120	130	150	58	320	170	95	120	150	210	300	
Total Suspended Solids (TSS)	mg/L as CaCO ₃	47	820	280	320	94	120	300	720	970	13000	6900	4500	3700	6900	10000	12000	18000	110000	62000	35000	34000	63000	91000	100000	
Total Hardness	mg/L as CaCO ₃	110	200	150	35	130	140	160	190	90	110	98	6	93	97	100	110	40	70	53	12	43	51	61	68	
MAJOR IONS																										
Calcium (Ca)	mg/L	36	73	53	13	46	51	57	70	26	30	28	1.6	27	28	29	30	12	21	16	3.3	14	16	19	20	
Magnesium (Mg)	mg/L	3.8	4.8	4.3	0.43	4.0	4.4	4.8	4.8	6.1	7.5	6.7	0.59	6.2	6.6	7.2	7.4	2.1	4.4	3	0.95	2.1	2.7	3.5	4.2	
Potassium (K)	mg/L	0.91	2.1	1.5	0.52	0.98	1.4	1.9	2.1	0.95	1.5	1.2	0.24	0.97	1.1	1.3	1.5	0.5	1.8	0.91	0.54	0.6	0.64	0.96	1.7	
Sodium (Na)	mg/L	1.6	4.1	2.8	1.1	1.8	2.7	3.6	4	2.8	7	4.6	1.6	3.4	4.2	5.4	6.7	1.3	9.9	3.8	3.5	1.6	2	4.3	8.8	
Chloride (Cl)	mg/L	1.2	2.9	2	0.6	1.7	2.1	2.4	2.8	0.46	0.72	0.60	0.10	0.54	0.62	0.68	0.71	0.42	1	0.64	0.22	0.48	0.57	0.72	0.94	
Fluoride (F)	mg/L	<0.05	0.12	0.055	0.039	0.025	0.038	0.068	0.11	0.025	0.05	0.031	0.011	0.025	0.025	0.031	0.046	0.025	0.06	0.034	0.015	0.025	0.025	0.034	0.055	
Sulphate (SO ₄)	mg/L	6.4	8	7.1	0.58	6.7	7.1	7.5	7.9	12	14	13	0.6	13	14	14	14	5.2	5.8	5.6	0.23	5.5	5.6	5.7	5.8	
METALS																										
Aluminum (Al)	mg/L	0.005	0.043	0.026	0.014	0.016	0.027	0.036	0.042	0.007	0.012	0.0095	0.0021	0.0078	0.0095	0.011	0.012	0.012	0.064	0.028	0.021	0.014	0.018	0.033	0.058	
Antimony (Sb)	mg/L	<0.006	<0.006	<0.006	-	<0.006	<0.006	<0.006	<0.006	<0.006	<0.006	<0.006	-	<0.006	<0.006	<0.006	<0.006	<0.006	<0.006	<0.006	-	<0.006	<0.006	<0.006	<0.006	
Arsenic (As)	mg/L	0.0015	0.05	0.014	0.021	0.0015	0.0015	0.014	0.043	0.0015	0.05	0.014	0.021	0.0015	0.0015	0.014	0.043	0.0015	0.05	0.014	0.021	0.0015	0.0015	0.014	0.043	
Barium (Ba)	mg/L	0.035	0.04	0.037	0.0021	0.035	0.037	0.039	0.04	0.008	0.013	0.011	0.0019	0.0095	0.011	0.012	0.013	0.001	0.003	0.0016	0.00082	0.001	0.0013	0.0019	0.0028	
Beryllium (Be)	mg/L	<0.001	<0.001	<0.001	-	<0.001	<0.001	<0.001	<0.001	<0.001	<0.001	<0.001	-	<0.001	<0.001	<0.001	<0.001	<0.001	<0.001	<0.001	-	<0.001	<0.001	<0.001	<0.001	
Boron (B)	mg/L	0.005	0.023	0.0095	0.0078	0.005	0.005	0.0095	0.02	<0.01	<0.01	<0.01	-	<0.01	<0.01	<0.01	<0.01	<0.01	<0.01	<0.01	-	<0.01	<0.01	<0.01	<0.01	
Cadmium (Cd)	mg/L	<0.00002	<0.0001	0.00004	0.000017	0.00004	0.00005	0.00005	0.00005	0.00001	0.00005	0.00004	0.000017	0.00004	0.00005	0.00005	0.00005	0.00001	0.00005	0.00004	0.000017	0.00004	0.00005	0.00005	0.00005	
Chromium (Cr)	mg/L	<0.003	<0.003	<0.003	-	<0.003	<0.003	<0.003	<0.003	<0.003	<0.003	<0.003	-	<0.003	<0.003	<0.003	<0.003	<0.003	<0.003	<0.003	-	<0.003	<0.003	<0.003	<0.003	
Cobalt (Co)	mg/L	<0.0005	<0.0005	<0.0005	-	<0.0005	<0.0005	<0.0005	<0.0005	<0.0005	<0.0005	<0.0005	-	<0.0005	<0.0005	<0.0005	<0.0005	<0.0005	<0.0005	<0.0005	-	<0.0005	<0.0005	<0.0005	<0.0005	
Copper (Cu)	mg/L	0.0009	0.003	0.0015	0.00088	0.00098	0.001	0.0015	0.0027	0.0003	0.001	0.00083	0.0003	0.00083	0.001	0.001	0.001	0.0002	0.001	0.0008	0.00035	0.0008	0.001	0.001	0.001	
Iron (Fe)	mg/L	<0.01	<0.01	<0.01	-	<0.01	<0.01	<0.01	<0.01	0.01	0.12	0.046	0.045	0.01	0.028	0.064	0.11	<0.01	<0.01	<0.01	-	<0.01	<0.01	<0.01	<0.01	
Lead (Pb)	mg/L	0.00005	0.0005	0.00039	0.00019	0.00039	0.0005	0.0005	0.0005	0.00005	0.0005	0.00039	0.00019	0.00039	0.0005	0.0005	0.0005	0.00005	0.0005	0.00039	0.00019	0.00039	0.0005	0.0005	0.0005	
Manganese (Mn)	mg/L	0.001	0.12	0.059	0.057	0.0033	0.056	0.11	0.12	0.057	0.073	0.068	0.0064	0.068	0.071	0.072	0.073	0.002	0.007	0.0038	0.0019	0.0028	0.003	0.004	0.0064	
Mercury (Hg)	mg/L	0.0000013	0.00005	0.000038	0.000021	0.000038	0.00005	0.00005	0.00005	0.0000013	0.00005	0.000038	0.000021	0.000038	0.00005	0.00005	0.00005	0.0000013	0.00005	0.000038	0.000021	0.000038	0.00005	0.00005	0.00005	
Molybdenum (Mo)	mg/L	0.003	0.008	0.0058	0.0018	0.0053	0.006	0.0065	0.0077	0.003	0.013	0.007	0.0037	0.0045	0.006	0.0085	0.012	<0.002	<0.002	<0.002	-	<0.002	<0.002	<0.002	<0.002	
Nickel (Ni)	mg/L	0.0015	0.003	0.0019	0.00065	0.0015	0.0015	0.0019	0.0028	<0.003	<0.003	<0.003	-	<0.003	<0.003	<0.003	<0.003	<0.003	<0.003	<0.003	-	<0.003	<0.003	<0.003	<0.003	
Selenium (Se)	mg/L	0.002	0.05	0.014	0.021	0.002	0.002	0.014	0.043	0.002	0.05	0.014	0.021	0.002	0.002	0.014	0.043	0.001	0.002	0.0015	0.00082	0.0015	0.002	0.002	0.002	
Silver (Ag)	mg/L	0.000005	0.0001	0.000051	0.000034	0.000039	0.00005	0.000063	0.000093	0.00001	0.00005	0.00004	0.000017	0.00004	0.00005	0.00005	0.00005	0.00002	0.00005	0.000043	0.000013	0.000043	0.00005	0.00005	0.00005	
Strontium (Sr)	mg/L	0.059	0.082	0.072	0.0084	0.069	0.074	0.078	0.081	0.033	0.047	0.04	0.005	0.038	0.04	0.042	0.046	0.023	0.037	0.03	0.0052	0.026	0.029	0.033	0.036	
Thallium (Tl)	mg/L	0.000005	0.00015	0.00011	0.000063	0.00011	0.00015	0.00015	0.00015	0.000005	0.00015	0.00011	0.000063	0.00011	0.00015	0.00015	0.00015	0.00002	0.00015	0.00012	0.000056	0.00012	0.00015	0.00015	0.00015	
Titanium (Ti)	mg/L	<0.002	<0.002	<0.002	-	<0.002	<0.002	<0.002	<0.002	<0.002	<0.002	<0.002	-	<0.002	<0.002	<0.002	<0.002	<0.002	<0.002	<0.002	-	<0.002	<0.002	<0.002	<0.002	
Tungsten (W)	mg/L	0.005	0.032	0.014	0.011	0.005	0.009	0.018	0.029	0.005	0.02	0.0088	0.0065	0.005	0.005	0.0088	0.018	<0.01	<0.01	<0.01	-	<0.01	<0.01	<0.01	<0.01	
Uranium (U)	mg/L	0.001	0.003	0.002	0.00071	0.0018	0.002	0.0023	0.0029	<0.002	<0.002	<0.002	-	<0.002	<0.002	<0.002	<0.002	<0.002	<0.002	<0.002	-	<0.002	<0.002	<0.002	<0.002	
Vanadium (V)	mg/L	<0.002	<0.002	<0.002	-	<0.002	<0.002	<0.002	<0.002	<0.002	<0.002	<0.002	-	<0.002	<0.002	<0.002	<0.002	<0.002	<0.002	<0.002	-	<0.002	<0.002	<0.002	<0.002	
Zinc (Zn)	mg/L	0.005	0.054	0.029	0.021	0.01	0.029	0.047	0.053	0.0025	0.005	0.0031	0.0011	0.0025	0.0025	0.0031	0.0046	0.0025	0.078	0.023	0.032	0.0025	0.0048	0.025	0.067	
Zirconium (Zr)	mg/L	<0.004	<0.004	<0.004	-	<0.004	<0.004	<0.004	<0.004	<0.004	<0.004	<0.004	-	<0.004	<0.004	<0.004	<0.004	<0.004	<0.004	<0.004	-	<0.004	<0.004	<0.004	<0.004	
OTHER PARAMETERS																										
Total Cyanide	mg/L	0.001	0.009	0.003	0.0035	0.001	0.0010	0.003	0.0078	0.001	0.006	0.0023	0.0023	0.001	0.001	0.0023	0.0053	0.001	0.001	0.001	0.001	0.001	0.001	0.001	0.001	
Total Ammonia (NH ₃ + NH ₄)	mg/L as N	0.01	0.03	0.015	0.0087	0.01	0.010	0.01																		

TABLE 3a
STATISTICAL SUMMARY OF UPDATED BASELINE GROUNDWATER QUALITY DATASET
CÔTÉ GOLD PROJECT

Parameter	Unit	BH12-3A (n=3)								BH12-3B (n=3)								BH12-4 (n=3)							
		Minimum	Maximum	Average	Standard Deviation	25th percentile	Median	75 th percentile	95 th percentile	Minimum	Maximum	Average	Standard Deviation	25th percentile	Median	75 th percentile	95 th percentile	Minimum	Maximum	Average	Standard Deviation	25th percentile	Median	75 th percentile	95 th percentile
GENERAL PARAMETERS																									
pH	pH units	7.70	8.00	7.80	0.12	7.80	7.80	7.90	7.90	7.20	7.50	7.30	0.14	7.20	7.20	7.40	7.50	7.60	7.80	7.70	0.06	7.60	7.70	7.70	7.80
Alkalinity	mg/L as CaCO ₃	95	120	110	8.3	100	110	110	110	40	61	49	8.8	43	46	54	60	53	80	64	12	56	59	70	78
Electrical Conductivity (EC)	µS/cm	220	250	240	10	240	250	250	250	100	140	120	15	110	120	130	140	120	160	140	17	130	140	150	160
Total Dissolved Solids (TDS)	mg/L	140	150	150	3.3	150	150	150	150	66	170	110	46	77	88	130	160	84	120	97	14	87	90	100	110
Total Suspended Solids (TSS)	mg/L as CaCO ₃	210	1200	650	430	360	520	880	1200	2400	28000	12000	12000	3400	4300	16000	25000	280	7100	3000	2900	1000	1800	4400	6500
Total Hardness	mg/L as CaCO ₃	120	120	120	1.7	120	120	120	120	52	65	56	6.4	52	52	59	64	62	71	66	4	63	65	68	71
MAJOR IONS																									
Calcium (Ca)	mg/L	42	43	42	0.59	42	42	42	43	19	24	21	2.5	19	19	22	24	21	22	22	0.73	21	22	22	22
Magnesium (Mg)	mg/L	3.7	3.8	3.7	0.058	3.7	3.8	3.8	3.8	0.91	1.2	1.1	0.12	1	1.1	1.1	1.2	2.4	3.8	2.9	0.64	2.4	2.5	3.1	3.7
Potassium (K)	mg/L	0.69	1.6	1.2	0.36	0.98	1.3	1.4	1.5	0.26	0.68	0.44	0.18	0.32	0.38	0.53	0.65	0.55	1.4	1	0.35	0.81	1.1	1.2	1.4
Sodium (Na)	mg/L	2.3	5.2	3.6	1.2	2.8	3.2	4.2	5	1.7	2.2	2	0.18	1.9	2	2.1	2.1	1.8	11	5.2	3.8	2.6	3.4	6.9	9.8
Chloride (Cl)	mg/L	1.2	1.7	1.5	0.2	1.4	1.6	1.7	1.7	0.95	1.8	1.3	0.36	1.1	1.2	1.5	1.7	0.64	1.9	1.3	0.53	0.97	1.3	1.6	1.9
Fluoride (F)	mg/L	0.025	0.12	0.078	0.04	0.058	0.09	0.11	0.12	0.025	0.06	0.037	0.016	0.025	0.025	0.043	0.057	0.025	0.11	0.053	0.04	0.025	0.025	0.068	0.1
Sulphate (SO ₄)	mg/L	14	23	19	3.8	17	20	22	23	7	11	8.6	1.5	7.6	8.1	9.4	10	7.4	8.8	8.2	0.57	7.9	8.4	8.6	8.7
METALS																									
Aluminum (Al)	mg/L	0.01	0.015	0.013	0.0021	0.012	0.013	0.014	0.015	0.029	0.1	0.053	0.033	0.03	0.03	0.065	0.093	0.017	0.074	0.04	0.024	0.024	0.03	0.052	0.07
Antimony (Sb)	mg/L	<0.006	<0.006	<0.006	-	<0.006	<0.006	<0.006	<0.006	<0.006	<0.006	<0.006	-	<0.006	<0.006	<0.006	<0.006	<0.006	<0.006	<0.006	-	<0.006	<0.006	<0.006	<0.006
Arsenic (As)	mg/L	<0.003	<0.003	<0.003	-	<0.003	<0.003	<0.003	<0.003	<0.003	<0.003	<0.003	-	<0.003	<0.003	<0.003	<0.003	<0.003	<0.003	<0.003	-	<0.003	<0.003	<0.003	<0.003
Barium (Ba)	mg/L	0.016	0.018	0.017	0.00082	0.017	0.017	0.018	0.018	0.002	0.004	0.003	0.00082	0.0025	0.003	0.0035	0.0039	0.011	0.013	0.012	0.00082	0.012	0.012	0.013	0.013
Beryllium (Be)	mg/L	<0.001	<0.001	<0.001	-	<0.001	<0.001	<0.001	<0.001	<0.001	<0.001	<0.001	-	<0.001	<0.001	<0.001	<0.001	<0.001	<0.001	<0.001	-	<0.001	<0.001	<0.001	<0.001
Boron (B)	mg/L	<0.01	<0.01	<0.01	-	<0.01	<0.01	<0.01	<0.01	0.005	0.011	0.007	0.0028	0.005	0.005	0.008	0.01	0.005	0.011	0.007	0.0028	0.005	0.005	0.008	0.01
Cadmium (Cd)	mg/L	<0.0001	<0.0001	<0.0001	-	<0.0001	<0.0001	<0.0001	<0.0001	<0.0001	<0.0001	<0.0001	-	<0.0001	<0.0001	<0.0001	<0.0001	<0.0001	<0.0001	<0.0001	-	<0.0001	<0.0001	<0.0001	<0.0001
Chromium (Cr)	mg/L	<0.003	<0.003	<0.003	-	<0.003	<0.003	<0.003	<0.003	<0.003	<0.003	<0.003	-	<0.003	<0.003	<0.003	<0.003	<0.003	<0.003	<0.003	-	<0.003	<0.003	<0.003	<0.003
Cobalt (Co)	mg/L	<0.0005	<0.0005	<0.0005	-	<0.0005	<0.0005	<0.0005	<0.0005	<0.0005	<0.0005	<0.0005	-	<0.0005	<0.0005	<0.0005	<0.0005	0.00025	0.0009	0.00047	0.00031	0.00025	0.00025	0.00058	0.00084
Copper (Cu)	mg/L	0.001	0.004	0.0023	0.0012	0.0015	0.002	0.003	0.0038	0.004	0.005	0.0043	0.00047	0.004	0.004	0.0045	0.0049	0.001	0.016	0.0067	0.0066	0.002	0.003	0.0095	0.015
Iron (Fe)	mg/L	0.005	0.12	0.044	0.055	0.005	0.005	0.064	0.11	0.005	0.057	0.03	0.021	0.017	0.028	0.043	0.054	0.005	0.058	0.023	0.025	0.005	0.005	0.032	0.053
Lead (Pb)	mg/L	<0.001	<0.001	<0.001	-	<0.001	<0.001	<0.001	<0.001	<0.001	<0.001	<0.001	-	<0.001	<0.001	<0.001	<0.001	<0.001	<0.001	<0.001	-	<0.001	<0.001	<0.001	<0.001
Manganese (Mn)	mg/L	0.043	0.13	0.083	0.034	0.062	0.081	0.1	0.12	0.005	0.02	0.013	0.0061	0.009	0.013	0.017	0.019	0.025	0.17	0.077	0.065	0.032	0.038	0.1	0.16
Mercury (Hg)	mg/L	<0.0001	<0.0001	<0.0001	-	<0.0001	<0.0001	<0.0001	<0.0001	<0.0001	<0.0001	<0.0001	-	<0.0001	<0.0001	<0.0001	<0.0001	<0.0001	<0.0001	<0.0001	-	<0.0001	<0.0001	<0.0001	<0.0001
Molybdenum (Mo)	mg/L	0.041	0.089	0.068	0.02	0.057	0.073	0.081	0.087	<0.01	<0.01	<0.01	-	<0.01	<0.01	<0.01	<0.01	0.001	0.003	0.0017	0.00094	0.001	0.001	0.002	0.0028
Nickel (Ni)	mg/L	<0.003	<0.003	<0.003	-	<0.003	<0.003	<0.003	<0.003	<0.003	<0.003	<0.003	-	<0.003	<0.003	<0.003	<0.003	<0.003	<0.003	<0.003	-	<0.003	<0.003	<0.003	<0.003
Selenium (Se)	mg/L	<0.004	<0.004	<0.004	-	<0.004	<0.004	<0.004	<0.004	<0.004	<0.004	<0.004	-	<0.004	<0.004	<0.004	<0.004	<0.004	<0.004	<0.004	-	<0.004	<0.004	<0.004	<0.004
Silver (Ag)	mg/L	<0.0001	<0.0001	<0.0001	-	<0.0001	<0.0001	<0.0001	<0.0001	<0.0001	<0.0001	<0.0001	-	<0.0001	<0.0001	<0.0001	<0.0001	0.00005	0.0001	0.000067	0.000024	0.00005	0.00005	0.000075	0.000095
Strontium (Sr)	mg/L	0.04	0.046	0.042	0.0028	0.04	0.04	0.043	0.045	0.018	0.029	0.025	0.005	0.023	0.028	0.029	0.029	0.029	0.051	0.037	0.0097	0.031	0.032	0.042	0.049
Thallium (Tl)	mg/L	<0.0003	<0.0003	<0.0003	-	<0.0003	<0.0003	<0.0003	<0.0003	<0.0003	<0.0003	<0.0003	-	<0.0003	<0.0003	<0.0003	<0.0003	<0.0003	<0.0003	<0.0003	-	<0.0003	<0.0003	<0.0003	<0.0003
Titanium (Ti)	mg/L	<0.002	<0.002	<0.002	-	<0.002	<0.002	<0.002	<0.002	0.001	0.002	0.0013	0.00047	0.001	0.001	0.0015	0.0019	0.001	0.002	0.0013	0.00047	0.001	0.001	0.0015	0.0019
Tungsten (W)	mg/L	0.022	0.078	0.052	0.023	0.039	0.055	0.067	0.076	<0.01	<0.01	<0.01	-	<0.01	<0.01	<0.01	<0.01	0.023	0.21	0.097	0.083	0.039	0.055	0.13	0.2
Uranium (U)	mg/L	0.006	0.009	0.008	0.0014	0.0075	0.009	0.009	0.009	<0.002	<0.002	<0.002	-	<0.002	<0.002	<0.002	<0.002	0.001	0.008	0.0033	0.0033	0.001	0.001	0.0045	0.0073
Vanadium (V)	mg/L	<0.002	<0.002	<0.002	-	<0.002	<0.002	<0.002	<0.002	<0.002	<0.002	<0.002	-	<0.002	<0.002	<0.002	<0.002	<0.002	<0.002	<0.002	-	<0.002	<0.002	<0.002	<0.002
Zinc (Zn)	mg/L	0.0025	0.006	0.0037	0.0016	0.0025	0.0025	0.0043	0.0057	0.0025	0.15	0.063	0.06	0.022	0.041	0.093	0.13	0.01	0.022	0.017	0.0052	0.015	0.02	0.021	0.022
Zirconium (Zr)	mg/L	<0.004	<0.004	<0.004	-	<0.004	<0.004	<0.004	<0.004	<0.004	<0.004	<0.004	-	<0.004	<0.004	<0.004	<0.004	<0.004	<0.004	<0.004	-	<0.004	<0.004	<0.004	<0.004
OTHER PARAMETERS																									
Total Cyanide	mg/L	0.001	0.001	0.001	0.001	0.001	0.001	0.001	0.001	0.001	0.012	0.0047	0.0052	0.001	0.001	0.0065	0.011	<0.002	<0.002	<0.002	-	<0.002	<0.002	<0.002	<0.002
Total Ammonia (NH ₃ + NH ₄)	mg/L as N	0.01	0.02	0.013	0.0047	0.01	0.01	0.015	0.019	0.01	0.03	0.017	0.0094	0.01	0.01	0.02	0.								

TABLE 3a
STATISTICAL SUMMARY OF UPDATED BASELINE GROUNDWATER QUALITY DATASET
CÔTÉ GOLD PROJECT

Parameter	Unit	BH12-BULK1 (n=3)								DH12-PO-10 (n=4)								DH12-PO-14B (n=3)							
		Minimum	Maximum	Average	Standard Deviation	25th percentile	Median	75 th percentile	95 th percentile	Minimum	Maximum	Average	Standard Deviation	25th percentile	Median	75 th percentile	95 th percentile	Minimum	Maximum	Average	Standard Deviation	25th percentile	Median	75 th percentile	95 th percentile
GENERAL PARAMETERS																									
pH	pH units	7.70	8.00	7.90	0.10	7.80	7.90	7.90	8.00	7.90	8.10	8.00	0.11	7.90	7.90	8.00	8.10	7.80	8.00	7.90	0.09	7.90	7.90	8.00	8.00
Alkalinity	mg/L as CaCO ₃	110	120	120	3.9	110	110	120	120	140	150	140	5.4	140	140	150	150	91	110	97	5.5	94	96	99	100
Electrical Conductivity (EC)	µS/cm	270	300	280	14	270	280	290	300	280	340	300	25	290	300	310	340	190	230	210	13	200	200	210	220
Total Dissolved Solids (TDS)	mg/L	150	180	170	12	160	180	180	180	160	230	190	26	180	190	210	230	130	180	160	19	140	150	170	180
Total Suspended Solids (TSS)	mg/L as CaCO ₃	69	130	110	27	95	120	130	130	630	2000	1200	510	850	1100	1500	1900	5600	16000	10000	4400	5900	9100	13000	15000
Total Hardness	mg/L as CaCO ₃	130	150	140	6.9	140	140	150	150	140	140000	36000	62000	140	150	36000	120000	81	110	98	12	90	99	110	110
MAJOR IONS																									
Calcium (Ca)	mg/L	49	55	52	2.6	50	52	53	55	42	46	44	1.6	43	44	45	46	25	33	29	3.3	27	30	32	33
Magnesium (Mg)	mg/L	2.9	3.1	3	0.11	3	3	3.1	3.1	7.7	8.6	8.1	0.31	7.9	8	8.2	8.5	4.7	5400	1400	2300	5.9	6.8	1400	4600
Potassium (K)	mg/L	1.2	1.5	1.3	0.15	1.2	1.3	1.4	1.5	1.3	1.7	1.4	0.16	1.3	1.4	1.5	1.7	0.59	1.3	0.92	0.26	0.79	0.89	1	1.3
Sodium (Na)	mg/L	2.7	3.2	3	0.18	2.9	3	3.1	3.1	3.3	20	9.2	6.3	5.3	6.8	11	18	4.1	8.6	6.2	1.8	4.8	6.1	7.5	8.3
Chloride (Cl)	mg/L	1.4	1.6	1.5	0.083	1.5	1.5	1.6	1.6	0.9	2.7	1.8	0.64	1.5	1.8	2	2.6	2.4	4.2	3.2	0.7	2.6	3	3.7	4.1
Fluoride (F)	mg/L	0.025	0.11	0.075	0.036	0.058	0.09	0.1	0.11	0.1	0.14	0.12	0.015	0.11	0.11	0.12	0.14	0.025	0.14	0.099	0.047	0.074	0.12	0.14	0.14
Sulphate (SO ₄)	mg/L	25	34	30	3.5	27	29	32	34	5.1	33	14	11	5.2	8.2	17	29	8.3	9.8	9	0.69	8.4	9	9.6	9.8
METALS																									
Aluminum (Al)	mg/L	0.008	0.015	0.011	0.0029	0.0095	0.011	0.013	0.015	0.007	0.2	0.061	0.078	0.015	0.02	0.065	0.17	0.015	0.094	0.04	0.032	0.023	0.025	0.042	0.084
Antimony (Sb)	mg/L	<0.006	<0.006	<0.006	-	<0.006	<0.006	<0.006	<0.006	<0.006	<0.006	<0.006	-	<0.006	<0.006	<0.006	<0.006	<0.006	<0.006	<0.006	-	<0.006	<0.006	<0.006	<0.006
Arsenic (As)	mg/L	<0.003	<0.003	<0.003	-	<0.003	<0.003	<0.003	<0.003	0.0015	0.05	0.015	0.02	0.0015	0.0038	0.017	0.043	<0.003	<0.003	<0.003	-	<0.003	<0.003	<0.003	<0.003
Barium (Ba)	mg/L	0.025	0.043	0.035	0.0074	0.031	0.036	0.04	0.042	0.007	0.038	0.026	0.011	0.022	0.029	0.032	0.037	0.013	0.018	0.015	0.0018	0.015	0.015	0.016	0.018
Beryllium (Be)	mg/L	<0.001	<0.001	<0.001	-	<0.001	<0.001	<0.001	<0.001	<0.001	<0.001	<0.001	-	<0.001	<0.001	<0.001	<0.001	<0.001	<0.001	<0.001	-	<0.001	<0.001	<0.001	<0.001
Boron (B)	mg/L	0.005	0.012	0.009	0.0029	0.0075	0.01	0.011	0.012	0.005	0.015	0.011	0.0038	0.01	0.013	0.014	0.015	<0.01	<0.01	<0.01	-	<0.01	<0.01	<0.01	<0.01
Cadmium (Cd)	mg/L	0.00005	0.0001	0.000083	0.000024	0.000075	0.0001	0.0001	0.0001	0.00001	0.00005	0.00004	0.000017	0.00004	0.00005	0.00005	0.00005	<0.0001	<0.0001	<0.0001	-	<0.0001	<0.0001	<0.0001	<0.0001
Chromium (Cr)	mg/L	<0.003	<0.003	<0.003	-	<0.003	<0.003	<0.003	<0.003	<0.003	<0.003	<0.003	-	<0.003	<0.003	<0.003	<0.003	<0.003	<0.003	<0.003	-	<0.003	<0.003	<0.003	<0.003
Cobalt (Co)	mg/L	0.00025	0.0006	0.00037	0.00016	0.00025	0.00025	0.00043	0.00057	0.00025	0.0008	0.0005	0.00025	0.00025	0.00048	0.00073	0.00079	<0.0005	<0.0005	<0.0005	-	<0.0005	<0.0005	<0.0005	<0.0005
Copper (Cu)	mg/L	0.001	0.004	0.0027	0.0012	0.002	0.003	0.0035	0.0039	0.003	0.008	0.0054	0.0022	0.0034	0.0053	0.0073	0.0079	<0.002	<0.002	<0.002	-	<0.002	<0.002	<0.002	<0.002
Iron (Fe)	mg/L	0.005	0.11	0.038	0.047	0.005	0.005	0.055	0.095	0.005	0.14	0.046	0.053	0.005	0.022	0.062	0.12	0.032	31	7.8	13	0.63	0.081	7.8	26
Lead (Pb)	mg/L	<0.001	<0.001	<0.001	-	<0.001	<0.001	<0.001	<0.001	0.00005	0.0005	0.00039	0.00019	0.00039	0.0005	0.0005	0.0005	<0.001	<0.001	<0.001	-	<0.001	<0.001	<0.001	<0.001
Manganese (Mn)	mg/L	0.042	0.31	0.15	0.12	0.068	0.094	0.2	0.29	0.039	0.27	0.15	0.086	0.086	0.14	0.21	0.25	0.053	0.064	0.059	0.0044	0.055	0.059	0.063	0.064
Mercury (Hg)	mg/L	<0.0001	<0.0001	<0.0001	-	<0.0001	<0.0001	<0.0001	<0.0001	0.0000013	0.00005	0.000038	0.000021	0.000038	0.00005	0.00005	0.00005	<0.0001	<0.0001	<0.0001	-	<0.0001	<0.0001	<0.0001	<0.0001
Molybdenum (Mo)	mg/L	0.11	0.15	0.13	0.016	0.12	0.13	0.14	0.15	0.001	0.048	0.024	0.017	0.013	0.024	0.035	0.045	0.005	0.01	0.0078	0.0023	0.0058	0.008	0.01	0.01
Nickel (Ni)	mg/L	0.0015	0.003	0.002	0.00071	0.0015	0.0015	0.0023	0.0029	0.0015	0.009	0.0043	0.0031	0.0015	0.0033	0.006	0.0084	<0.003	<0.003	<0.003	-	<0.003	<0.003	<0.003	<0.003
Selenium (Se)	mg/L	<0.004	<0.004	<0.004	-	<0.004	<0.004	<0.004	<0.004	0.0002	0.002	0.0016	0.00078	0.0016	0.002	0.002	0.002	<0.004	<0.004	<0.004	-	<0.004	<0.004	<0.004	<0.004
Silver (Ag)	mg/L	<0.0001	<0.0001	<0.0001	-	<0.0001	<0.0001	<0.0001	<0.0001	0.00002	0.00005	0.000043	0.000013	0.000043	0.00005	0.00005	0.00005	<0.0001	<0.0001	<0.0001	-	<0.0001	<0.0001	<0.0001	<0.0001
Strontium (Sr)	mg/L	0.054	0.063	0.058	0.0039	0.055	0.056	0.06	0.062	0.042	0.11	0.08	0.024	0.072	0.085	0.093	0.11	0.065	0.079	0.07	0.0057	0.065	0.067	0.072	0.078
Thallium (Tl)	mg/L	<0.0003	<0.0003	<0.0003	-	<0.0003	<0.0003	<0.0003	<0.0003	0.000005	0.00015	0.00011	0.000063	0.00011	0.00015	0.00015	0.00015	<0.0003	<0.0003	<0.0003	-	<0.0003	<0.0003	<0.0003	<0.0003
Titanium (Ti)	mg/L	<0.002	<0.002	<0.002	-	<0.002	<0.002	<0.002	<0.002	<0.002	<0.002	<0.002	-	<0.002	<0.002	<0.002	<0.002	<0.002	<0.002	<0.002	-	<0.002	<0.002	<0.002	<0.002
Tungsten (W)	mg/L	0.005	0.014	0.008	0.0042	0.005	0.005	0.0095	0.013	0.021	0.091	0.058	0.025	0.046	0.059	0.071	0.087	0.028	0.094	0.064	0.029	0.039	0.068	0.093	0.094
Uranium (U)	mg/L	0.007	0.014	0.011	0.0031	0.01	0.013	0.014	0.014	0.001	0.002	0.0013	0.00043	0.001	0.001	0.0013	0.0019	<0.002	<0.002	<0.002	-	<0.002	<0.002	<0.002	<0.002
Vanadium (V)	mg/L	<0.002	<0.002	<0.002	-	<0.002	<0.002	<0.002	<0.002	0.001	0.002	0.0013	0.00043	0.001	0.001	0.0013	0.0019	<0.002	<0.002	<0.002	-	<0.002	<0.002	<0.002	<0.002
Zinc (Zn)	mg/L	0.0025	0.009	0.0065	0.0029	0.0053	0.008	0.0085	0.0089	0.01	0.39	0.21	0.18	0.048	0.22	0.39	0.39	0.0025	28	7	12	0.018	0.088	7.1	24
Zirconium (Zr)	mg/L	<0.004	<0.004	<0.004	-	<0.004	<0.004	<0.004	<0.004	<0.004	<0.004	<0.004	-	<0.004	<0.004	<0.004	<0.004	<0.004	<0.004	<0.004	-	<0.004	<0.004	<0.004	<0.004
OTHER PARAMETERS																									
Total Cyanide	mg/L	<0.002	<0.002	<0.002	-	<0.002	<0.002	<0.002	<0.002	0.001	0.003	0.002	0.001	0.001	0.002	0.003	0.003	<0.002	<0.002	<0.002	-	<0.002	<0.002	<0.002	<0.002
Total Ammonia (NH ₃ + NH ₄)	mg/L as N	0.01	0.04	0.02	0.014	0.01	0.01	0.025	0.037	0.01	0.04	0.025	0.015	0.01	0.025	0.04	0.04	<0.002	<0.002	<					

TABLE 3a
STATISTICAL SUMMARY OF UPDATED BASELINE GROUNDWATER QUALITY DATASET
CÔTÉ GOLD PROJECT

Parameter	Unit	DH12-TMF-05A (n=7)								DH12-TMF-05B (n=7)								DH12-TMF-12 (n=7)							
		Minimum	Maximum	Average	Standard Deviation	25th percentile	Median	75 th percentile	95 th percentile	Minimum	Maximum	Average	Standard Deviation	25th percentile	Median	75 th percentile	95 th percentile	Minimum	Maximum	Average	Standard Deviation	25th percentile	Median	75 th percentile	95 th percentile
GENERAL PARAMETERS																									
pH	pH units	7.50	8.00	7.80	0.19	7.70	7.90	8.00	8.00	7.00	8.20	7.70	0.36	7.60	7.90	7.90	8.10	7.40	8.00	7.80	0.20	7.60	7.80	8.00	8.00
Alkalinity	mg/L as CaCO ₃	130	150	140	8.2	140	140	150	150	230	550	350	120	260	330	420	530	87	100	92	5.4	88	89	94	100
Electrical Conductivity (EC)	µS/cm	390	590	450	61	420	430	440	550	460	1100	710	220	510	710	860	1000	740	890	810	54	760	820	850	880
Total Dissolved Solids (TDS)	mg/L	210	400	300	81	230	270	390	400	360	710	540	120	460	560	600	690	470	750	580	77	560	570	580	700
Total Suspended Solids (TSS)	mg/L as CaCO ₃	210	2600	680	810	270	340	510	2000	340	26000	9400	8100	3800	5700	13000	22000	61	2400	890	800	310	570	1300	2200
Total Hardness	mg/L as CaCO ₃	130	150000	22000	53000	140	140	150	110000	150	230	190	23	190	200	200	220	320	370	350	15	340	350	360	370
MAJOR IONS																									
Calcium (Ca)	mg/L	38	46	41	2.4	39	40	42	45	41	62	53	5.9	51	53	55	60	82	92	88	3.5	85	88	91	92
Magnesium (Mg)	mg/L	7.6	11	9.8	1.2	9.4	9.9	11	11	12	19	15	2	14	16	18	18	28	34	32	1.7	31	31	32	34
Potassium (K)	mg/L	2.4	4.8	3.2	0.79	2.6	3	3.6	4.5	2.6	3.7	3.1	0.34	2.8	3.1	3.3	3.6	2.1	2.5	2.2	0.12	2.2	2.2	2.3	2.4
Sodium (Na)	mg/L	23	77	37	18	26	30	38	66	36	170	92	47	47	96	120	160	28	39	34	3.4	33	35	36	38
Chloride (Cl)	mg/L	5.3	15	7.9	3.2	6	6.7	7.9	13	5.1	14	9.9	3.2	7	11	13	13	16	18	17	0.5	17	18	18	18
Fluoride (F)	mg/L	0.28	0.88	0.68	0.18	0.68	0.74	0.75	0.84	0.025	0.16	0.084	0.053	0.025	0.1	0.13	0.15	0.025	0.27	0.1	0.082	0.025	0.13	0.13	0.23
Sulphate (SO ₄)	mg/L	43	150	71	35	49	64	71	130	1.6	79	22	26	2.6	12	30	65	280	320	300	11	300	300	310	310
METALS																									
Aluminum (Al)	mg/L	0.007	0.15	0.049	0.054	0.009	0.014	0.079	0.14	0.043	0.14	0.11	0.035	0.08	0.12	0.14	0.14	0.002	0.012	0.0057	0.0037	0.002	0.005	0.0085	0.011
Antimony (Sb)	mg/L	<0.006	<0.006	<0.006	-	<0.006	<0.006	<0.006	<0.006	<0.006	<0.006	<0.006	-	<0.006	<0.006	<0.006	<0.006	<0.006	<0.006	<0.006	-	<0.006	<0.006	<0.006	<0.006
Arsenic (As)	mg/L	0.0015	0.05	0.0084	0.017	0.0015	0.0015	0.0015	0.035	0.0015	0.05	0.0084	0.017	0.0015	0.0015	0.0015	0.035	0.0015	0.05	0.0084	0.017	0.0015	0.0015	0.0015	0.035
Barium (Ba)	mg/L	0.028	0.059	0.037	0.01	0.03	0.031	0.039	0.054	0.035	0.065	0.049	0.012	0.038	0.045	0.061	0.064	0.018	0.03	0.023	0.0037	0.021	0.022	0.025	0.029
Beryllium (Be)	mg/L	<0.001	<0.001	<0.001	-	<0.001	<0.001	<0.001	<0.001	<0.001	<0.001	<0.001	-	<0.001	<0.001	<0.001	<0.001	<0.001	<0.001	<0.001	-	<0.001	<0.001	<0.001	<0.001
Boron (B)	mg/L	0.031	0.036	0.033	0.0016	0.033	0.033	0.035	0.036	0.005	0.023	0.013	0.0064	0.0085	0.012	0.018	0.022	0.005	0.053	0.041	0.015	0.043	0.047	0.05	0.052
Cadmium (Cd)	mg/L	0.00001	0.00005	0.000044	0.000014	0.00005	0.00005	0.00005	0.00005	0.00001	0.00005	0.000044	0.000014	0.00005	0.00005	0.00005	0.00005	0.00001	0.00005	0.000044	0.000014	0.00005	0.00005	0.00005	0.00005
Chromium (Cr)	mg/L	<0.003	<0.003	<0.003	-	<0.003	<0.003	<0.003	<0.003	0.003	0.009	0.006	0.002	0.0045	0.006	0.0075	0.0087	<0.003	<0.003	<0.003	-	<0.003	<0.003	<0.003	<0.003
Cobalt (Co)	mg/L	0.00025	0.0006	0.0003	0.00012	0.00025	0.00025	0.00025	0.0005	0.0011	0.0039	0.0021	0.00096	0.0014	0.0016	0.0028	0.0036	<0.0005	<0.0005	<0.0005	-	<0.0005	<0.0005	<0.0005	<0.0005
Copper (Cu)	mg/L	0.0006	0.002	0.0012	0.00051	0.001	0.001	0.0015	0.002	0.001	0.0055	0.0016	0.0016	0.001	0.001	0.001	0.0042	0.0007	0.001	0.00096	0.0001	0.001	0.001	0.001	0.001
Iron (Fe)	mg/L	0.005	0.18	0.033	0.062	0.005	0.005	0.014	0.14	0.013	17	9.5	6.2	4.2	12	14	16	0.005	0.22	0.078	0.077	0.021	0.048	0.11	0.21
Lead (Pb)	mg/L	0.00005	0.0005	0.00044	0.00016	0.0005	0.0005	0.0005	0.0005	0.0003	0.0005	0.00047	0.00007	0.0005	0.0005	0.0005	0.0005	0.0001	0.0005	0.00044	0.00014	0.0005	0.0005	0.0005	0.0005
Manganese (Mn)	mg/L	0.042	0.32	0.15	0.083	0.098	0.15	0.18	0.28	0.43	0.74	0.64	0.11	0.58	0.7	0.73	0.74	0.83	1	0.9	0.069	0.85	0.87	0.94	1
Mercury (Hg)	mg/L	0.0000013	0.00005	0.000043	0.000017	0.00005	0.00005	0.00005	0.00005	0.0000013	0.00005	0.000043	0.000017	0.00005	0.00005	0.00005	0.00005	0.0000013	0.00005	0.000043	0.000017	0.00005	0.00005	0.00005	0.00005
Molybdenum (Mo)	mg/L	0.007	0.18	0.039	0.059	0.0075	0.01	0.033	0.14	0.001	0.005	0.002	0.0014	0.001	0.001	0.0025	0.0044	0.003	0.005	0.0036	0.00073	0.003	0.003	0.004	0.0047
Nickel (Ni)	mg/L	0.0015	0.006	0.0035	0.0018	0.0015	0.004	0.005	0.0057	0.0015	0.005	0.0025	0.0016	0.0015	0.0015	0.0033	0.005	0.0015	0.003	0.0017	0.00052	0.0015	0.0015	0.0015	0.0026
Selenium (Se)	mg/L	0.0002	0.002	0.0017	0.00063	0.002	0.002	0.002	0.002	0.002	0.05	0.0089	0.017	0.002	0.002	0.036	0.006	0.006	0.002	0.0018	0.00049	0.002	0.002	0.002	0.002
Silver (Ag)	mg/L	0.00003	0.00005	0.000047	0.000007	0.00005	0.00005	0.00005	0.00005	0.000005	0.00005	0.000044	0.000016	0.00005	0.00005	0.00005	0.00005	0.000002	0.00005	0.000046	0.00001	0.00005	0.00005	0.00005	0.00005
Strontium (Sr)	mg/L	0.29	0.33	0.31	0.014	0.3	0.31	0.32	0.33	0.14	0.22	0.18	0.024	0.17	0.18	0.19	0.21	0.52	0.79	0.61	0.08	0.57	0.59	0.61	0.74
Thallium (Tl)	mg/L	0.000005	0.00015	0.00013	0.000051	0.00015	0.00015	0.00015	0.00015	0.000005	0.00015	0.00013	0.000051	0.00015	0.00015	0.00015	0.00015	0.000005	0.00015	0.00013	0.000051	0.00015	0.00015	0.00015	0.00015
Titanium (Ti)	mg/L	0.001	0.005	0.0017	0.0014	0.001	0.001	0.0015	0.0041	0.003	0.02	0.011	0.0052	0.007	0.011	0.013	0.018	0.001	0.006	0.0036	0.0017	0.0025	0.003	0.005	0.0057
Tungsten (W)	mg/L	0.005	0.015	0.0071	0.0036	0.005	0.005	0.0075	0.014	<0.01	<0.01	<0.01	-	<0.01	<0.01	<0.01	<0.01	<0.01	<0.01	-	<0.01	<0.01	<0.01	<0.01	<0.01
Uranium (U)	mg/L	0.003	0.007	0.0044	0.0013	0.0035	0.004	0.005	0.0064	<0.002	<0.002	<0.002	-	<0.002	<0.002	<0.002	<0.002	0.003	0.004	0.0037	0.00045	0.0035	0.004	0.004	0.004
Vanadium (V)	mg/L	<0.002	<0.002	<0.002	-	<0.002	<0.002	<0.002	<0.002	0.001	0.006	0.0043	0.0019	0.003	0.005	0.006	0.006	<0.002	<0.002	<0.002	-	<0.002	<0.002	<0.002	<0.002
Zinc (Zn)	mg/L	0.0025	0.096	0.029	0.034	0.0025	0.005	0.047	0.085	0.0025	1.3	0.18	0.43	0.043	0.009	0.012	0.88	0.0025	0.016	0.0052	0.0048	0.0025	0.0025	0.0053	0.014
Zirconium (Zr)	mg/L	<0.004	<0.004	<0.004	-	<0.004	<0.004	<0.004	<0.004	<0.004	<0.004	<0.004	-	<0.004	<0.004	<0.004	<0.004	<0.004	<0.004	<0.004	-	<0.004	<0.004	<0.004	<0.004
OTHER PARAMETERS																									
Total Cyanide	mg/L	0.0010	0.0020	0.0011	0.00035	0.0010	0.0010	0.0010	0.0017	0.001	0.025	0.0044	0.0084	0.001	0.001	0.001	0.018	<0.002	<0.002	<0.002	-	<0.002	<0.002	<0.002	<0.002
Total Ammonia (NH ₃ + NH ₄)	mg/L as N	0.01	0.07	0.024	0.023	0.01	0.01	0.03	0.064	0.2	0.94	0.51	0.28	0.3	0.35	0.74	0.92	0.01	0.22	0.064	0.069	0.015	0.04	0.075	0.18

Notes:

TABLE 3a
STATISTICAL SUMMARY OF UPDATED BASELINE GROUNDWATER QUALITY DATASET
CÔTÉ GOLD PROJECT

Parameter	Unit	DH12-TMF-16 (n=3)								DH12-TMF-27A (n=7)								DH12-TMF-27B (n=7)							
		Minimum	Maximum	Average	Standard Deviation	25th percentile	Median	75 th percentile	95 th percentile	Minimum	Maximum	Average	Standard Deviation	25th percentile	Median	75 th percentile	95 th percentile	Minimum	Maximum	Average	Standard Deviation	25th percentile	Median	75 th percentile	95 th percentile
GENERAL PARAMETERS																									
pH	pH units	7.20	7.90	7.60	0.28	7.40	7.60	7.70	7.90	6.50	7.70	7.30	0.39	7.30	7.40	7.60	7.70	6.30	8.20	7.40	0.54	7.30	7.50	7.70	8.10
Alkalinity	mg/L as CaCO ₃	55	64	59	3.7	57	59	62	64	27	120	53	29	40	42	49	100	28	140	66	48	34	40	91	140
Electrical Conductivity (EC)	µS/cm	130	140	130	1.4	130	130	130	140	67	260	130	58	96	100	140	220	77	310	150	97	89	93	200	310
Total Dissolved Solids (TDS)	mg/L	80	92	86	4.9	83	86	89	91	64	150	81	29	65	72	77	130	56	190	100	53	61	70	140	190
Total Suspended Solids (TSS)	mg/L as CaCO ₃	150	1300	530	510	160	180	710	1100	600	3800	2100	1200	1100	1800	3200	3700	1900	11000	5700	3500	2200	5500	8600	11000
Total Hardness	mg/L as CaCO ₃	62	59000	20000	28000	62	63	29000	53000	27	130	55	32	39	44	52	110	29	150	68	51	34	41	94	150
MAJOR IONS																									
Calcium (Ca)	mg/L	16	17	17	0.62	17	17	17	17	6.3	38	14	9.8	9.4	11	13	31	6.1	44	17	16	6.7	7.9	24	43
Magnesium (Mg)	mg/L	4.5	4.7	4.6	0.076	4.6	4.6	4.7	4.7	2.8	8.8	4.7	1.8	3.7	4.2	5	7.8	3.3	10	6.1	2.7	4.1	5.2	7.9	10
Potassium (K)	mg/L	0.36	0.44	0.41	0.035	0.4	0.43	0.44	0.44	0.32	1.3	0.61	0.32	0.44	0.47	0.65	1.2	0.38	1.3	0.69	0.34	0.43	0.57	0.88	1.2
Sodium (Na)	mg/L	1.8	2.1	2	0.16	1.9	2	2.1	2.1	1.4	5.1	2.5	1.2	1.8	1.9	2.7	4.6	2	3.2	2.4	0.42	2.1	2.3	2.7	3
Chloride (Cl)	mg/L	0.28	0.42	0.34	0.06	0.3	0.31	0.37	0.41	0.26	0.64	0.46	0.13	0.37	0.48	0.55	0.63	0.35	0.82	0.5	0.17	0.39	0.44	0.57	0.78
Fluoride (F)	mg/L	0.025	0.07	0.048	0.018	0.038	0.05	0.06	0.068	0.025	0.18	0.076	0.054	0.025	0.07	0.11	0.16	0.025	0.08	0.038	0.021	0.025	0.025	0.043	0.74
Sulphate (SO ₄)	mg/L	5.8	6.1	5.9	0.14	5.8	5.9	6	6.1	4.4	12	6.1	2.4	4.6	4.8	6.3	10	4.6	14	7.4	4	4.8	5.2	9.2	14
METALS																									
Aluminum (Al)	mg/L	0.014	0.18	0.074	0.078	0.019	0.024	0.1	0.17	0.002	0.052	0.014	0.016	0.0055	0.009	0.012	0.041	0.004	0.039	0.016	0.012	0.0065	0.013	0.023	0.035
Antimony (Sb)	mg/L	<0.006	<0.006	<0.006	-	<0.006	<0.006	<0.006	<0.006	<0.006	<0.006	<0.006	-	<0.006	<0.006	<0.006	<0.006	<0.006	<0.006	<0.006	-	<0.006	<0.006	<0.006	<0.006
Arsenic (As)	mg/L	0.0015	0.05	0.018	0.023	0.0015	0.0015	0.026	0.045	0.0015	0.05	0.0084	0.017	0.0015	0.0015	0.035	0.0015	0.0015	0.05	0.0084	0.017	0.0015	0.0015	0.0015	0.035
Barium (Ba)	mg/L	0.002	0.006	0.0037	0.0017	0.0025	0.003	0.0045	0.0057	0.001	0.016	0.0056	0.0045	0.0035	0.004	0.0055	0.013	0.001	0.014	0.005	0.0054	0.0015	0.002	0.0075	0.014
Beryllium (Be)	mg/L	<0.001	<0.001	<0.001	-	<0.001	<0.001	<0.001	<0.001	<0.001	<0.001	<0.001	-	<0.001	<0.001	<0.001	<0.001	<0.001	<0.001	<0.001	-	<0.001	<0.001	<0.001	<0.001
Boron (B)	mg/L	<0.01	<0.01	<0.01	-	<0.01	<0.01	<0.01	<0.01	<0.01	<0.01	<0.01	-	<0.01	<0.01	<0.01	<0.01	<0.01	<0.01	<0.01	-	<0.01	<0.01	<0.01	<0.01
Cadmium (Cd)	mg/L	0.00001	0.00005	0.000037	0.000019	0.00003	0.00005	0.00005	0.00005	0.00001	0.00005	0.000044	0.000014	0.00005	0.00005	0.00005	0.00005	0.00001	0.0001	0.000051	0.000024	0.00005	0.00005	0.00005	0.000085
Chromium (Cr)	mg/L	<0.003	<0.003	<0.003	-	<0.003	<0.003	<0.003	<0.003	<0.003	<0.003	<0.003	-	<0.003	<0.003	<0.003	<0.003	<0.003	<0.003	<0.003	-	<0.003	<0.003	<0.003	<0.003
Cobalt (Co)	mg/L	<0.0005	<0.0005	<0.0005	-	<0.0005	<0.0005	<0.0005	<0.0005	<0.0005	<0.0005	<0.0005	-	<0.0005	<0.0005	<0.0005	<0.0005	<0.0005	<0.0005	<0.0005	-	<0.0005	<0.0005	<0.0005	<0.0005
Copper (Cu)	mg/L	0.0016	0.006	0.0032	0.002	0.0018	0.002	0.004	0.0056	0.001	0.003	0.0014	0.00073	0.001	0.001	0.0015	0.0027	0.0007	0.001	0.00096	0.0001	0.001	0.001	0.001	0.001
Iron (Fe)	mg/L	0.005	0.02	0.01	0.0071	0.005	0.005	0.013	0.019	0.005	0.015	0.0064	0.0035	0.005	0.005	0.005	0.012	<0.01	<0.01	<0.01	-	<0.01	<0.01	<0.01	<0.01
Lead (Pb)	mg/L	0.0002	0.0005	0.0004	0.00014	0.00035	0.0005	0.0005	0.0005	0.0001	0.0005	0.00044	0.00014	0.0005	0.0005	0.0005	0.0005	0.0002	0.0005	0.00046	0.0001	0.0005	0.0005	0.0005	0.0005
Manganese (Mn)	mg/L	0.002	0.017	0.008	0.0065	0.0035	0.005	0.011	0.016	0.004	0.056	0.02	0.018	0.006	0.012	0.029	0.049	0.001	0.018	0.0061	0.0064	0.001	0.002	0.01	0.017
Mercury (Hg)	mg/L	0.000013	0.00005	0.000034	0.000023	0.000026	0.00005	0.00005	0.00005	0.000013	0.000043	0.000017	0.00005	0.00005	0.00005	0.00005	0.00005	0.000013	0.00005	0.000043	0.000017	0.00005	0.00005	0.00005	0.00005
Molybdenum (Mo)	mg/L	<0.002	<0.002	<0.002	-	<0.002	<0.002	<0.002	<0.002	<0.002	<0.002	<0.002	-	<0.002	<0.002	<0.002	<0.002	<0.002	<0.002	<0.002	-	<0.002	<0.002	<0.002	<0.002
Nickel (Ni)	mg/L	<0.003	<0.003	<0.003	-	<0.003	<0.003	<0.003	<0.003	<0.003	<0.003	<0.003	-	<0.003	<0.003	<0.003	<0.003	<0.003	<0.003	<0.003	-	<0.003	<0.003	<0.003	<0.003
Selenium (Se)	mg/L	0.002	0.05	0.018	0.023	0.002	0.002	0.026	0.045	0.0003	0.002	0.0018	0.00059	0.002	0.002	0.002	0.002	0.0004	0.002	0.0018	0.00056	0.002	0.002	0.002	0.002
Silver (Ag)	mg/L	0.00004	0.0002	0.00011	0.000066	0.00007	0.0001	0.00015	0.00019	0.00005	0.0002	0.00011	0.00007	0.00005	0.00005	0.00019	0.0002	0.000005	0.00005	0.000044	0.000016	0.00005	0.00005	0.00005	0.00005
Strontium (Sr)	mg/L	0.019	0.034	0.025	0.0065	0.021	0.022	0.028	0.033	0.014	0.093	0.031	0.026	0.018	0.023	0.026	0.073	0.016	0.059	0.03	0.017	0.019	0.019	0.038	0.058
Thallium (Tl)	mg/L	0.000005	0.00015	0.0001	0.000068	0.000078	0.00015	0.00015	0.00015	0.000005	0.00015	0.00013	0.000051	0.00015	0.00015	0.00015	0.00015	0.000005	0.00015	0.00013	0.000051	0.00015	0.00015	0.00015	0.00015
Titanium (Ti)	mg/L	<0.002	<0.002	<0.002	-	<0.002	<0.002	<0.002	<0.002	0.001	0.003	0.0013	0.0007	0.001	0.001	0.001	0.0024	<0.002	<0.002	<0.002	-	<0.002	<0.002	<0.002	<0.002
Tungsten (W)	mg/L	0.017	0.074	0.038	0.025	0.021	0.024	0.049	0.069	0.005	0.042	0.016	0.015	0.005	0.005	0.026	0.041	<0.01	<0.01	<0.01	-	<0.01	<0.01	<0.01	<0.01
Uranium (U)	mg/L	<0.002	<0.002	<0.002	-	<0.002	<0.002	<0.002	<0.002	<0.002	<0.002	<0.002	-	<0.002	<0.002	<0.002	<0.002	0.001	0.003	0.0016	0.0009	0.001	0.001	0.002	0.003
Vanadium (V)	mg/L	0.001	0.002	0.0017	0.00047	0.0015	0.002	0.002	0.002	<0.002	<0.002	<0.002	-	<0.002	<0.002	<0.002	<0.002	<0.002	<0.002	<0.002	-	<0.002	<0.002	<0.002	<0.002
Zinc (Zn)	mg/L	0.0025	0.35	0.14	0.15	0.027	0.052	0.2	0.32	<0.005	<0.005	<0.005	-	<0.005	<0.005	<0.005	0.0025	0.022	0.0061	0.0068	0.0025	0.0025	0.0053	0.018	
Zirconium (Zr)	mg/L	<0.004	<0.004	<0.004	-	<0.004	<0.004	<0.004	<0.004	<0.004	<0.004	<0.004	-	<0.004	<0.004	<0.004	<0.004	<0.004	<0.004	<0.004	-	<0.004	<0.004	<0.004	<0.004
OTHER PARAMETERS																									
Total Cyanide	mg/L	<0.002	<0.002	<0.002	-	<0.002	<0.002	<0.002	<0.002	<0.002	<0.002	<0.002	-	<0.002	<0.002	<0.002	<0.002	<0.002	<0.002	<0.002	-	<0.002	<0.002	<0.002	<0.002
Total Ammonia (NH ₃ + NH ₄)	mg/L as N	0.01	0.16	0.06	0.071	0.01	0.01	0.085	0.15																

TABLE 3a
STATISTICAL SUMMARY OF UPDATED BASELINE GROUNDWATER QUALITY DATASET
CÔTÉ GOLD PROJECT

Parameter	Unit	DH12-TMF-28 (n=7)								DH12-TMF-31A (n=7)								DH12-TMF-31B (n=7)							
		Minimum	Maximum	Average	Standard Deviation	25th percentile	Median	75 th percentile	95 th percentile	Minimum	Maximum	Average	Standard Deviation	25th percentile	Median	75 th percentile	95 th percentile	Minimum	Maximum	Average	Standard Deviation	25th percentile	Median	75 th percentile	95 th percentile
GENERAL PARAMETERS																									
pH	pH units	7.50	8.10	7.80	0.21	7.60	7.80	7.90	8.00	7.30	8.20	7.90	0.26	7.80	7.90	8.00	8.10	6.80	7.80	7.30	0.38	7.00	7.60	7.60	7.80
Alkalinity	mg/L as CaCO ₃	94	140	110	17	99	110	130	140	110	130	120	6.5	110	120	120	130	39	83	54	16	43	46	63	80
Electrical Conductivity (EC)	µS/cm	330	480	370	47	350	360	380	460	230	250	240	5.6	240	240	250	250	100	180	130	29	110	120	140	180
Total Dissolved Solids (TDS)	mg/L	200	310	240	37	220	220	260	300	130	280	160	50	140	140	150	240	72	210	110	47	81	88	130	190
Total Suspended Solids (TSS)	mg/L as CaCO ₃	57	550	220	150	130	140	250	470	330	1100	630	250	460	580	720	1000	970	23000	6500	7700	1500	2800	8100	20000
Total Hardness	mg/L as CaCO ₃	87	170	130	25	120	140	150	160	120	130	120	4	120	120	130	130	41	95	58	18	46	52	64	89
MAJOR IONS																									
Calcium (Ca)	mg/L	22	45	36	6.9	34	39	40	44	42	46	44	1.5	43	44	45	46	15	35	22	6.9	17	19	24	33
Magnesium (Mg)	mg/L	7.5	14	11	1.8	9.5	11	12	13	2.7	3.7	3.2	0.31	2.9	3.2	3.3	3.6	0.8	1.8	1	0.34	0.85	0.92	0.95	1.6
Potassium (K)	mg/L	0.83	1.7	1.1	0.26	0.94	1.1	1.2	1.5	0.3	0.64	0.46	0.1	0.4	0.46	0.5	0.61	0.08	1.6	0.4	0.49	0.12	0.19	0.35	1.2
Sodium (Na)	mg/L	16	31	24	5	21	23	28	30	1.3	1.6	1.4	0.086	1.4	1.4	1.5	1.5	1.2	1.6	1.3	0.14	1.2	1.3	1.4	1.5
Chloride (Cl)	mg/L	1.9	7.1	4.3	1.7	3	4.2	5.4	6.6	0.5	0.67	0.55	0.054	0.52	0.52	0.56	0.64	0.25	1.2	0.54	0.27	0.42	0.5	0.53	0.98
Fluoride (F)	mg/L	0.58	1.1	0.89	0.17	0.81	0.88	1	1.1	<0.05	<0.05	<0.05	-	<0.05	<0.05	<0.05	<0.05	<0.05	<0.05	<0.05	-	<0.05	<0.05	<0.05	<0.05
Sulphate (SO ₄)	mg/L	27	100	66	23	53	70	80	97	8	8.9	8.4	0.3	8.2	8.4	8.7	8.8	6.6	9	7.5	0.83	6.6	7.5	7.9	8.7
METALS																									
Aluminum (Al)	mg/L	0.002	0.045	0.013	0.014	0.002	0.009	0.015	0.037	0.006	0.33	0.063	0.11	0.011	0.013	0.033	0.24	0.017	0.068	0.034	0.017	0.018	0.034	0.041	0.061
Antimony (Sb)	mg/L	<0.006	<0.006	<0.006	-	<0.006	<0.006	<0.006	<0.006	<0.006	<0.006	<0.006	-	<0.006	<0.006	<0.006	<0.006	<0.006	<0.006	<0.006	-	<0.006	<0.006	<0.006	<0.006
Arsenic (As)	mg/L	0.0015	0.05	0.0084	0.017	0.0015	0.0015	0.0015	0.035	0.0015	0.05	0.0084	0.017	0.0015	0.0015	0.0015	0.035	0.0015	0.05	0.0084	0.017	0.0015	0.0015	0.0015	0.035
Barium (Ba)	mg/L	0.023	0.057	0.034	0.01	0.028	0.03	0.035	0.051	0.004	0.008	0.0053	0.0015	0.004	0.005	0.006	0.0077	0.001	0.005	0.0024	0.0013	0.0015	0.002	0.003	0.0044
Beryllium (Be)	mg/L	<0.001	<0.001	<0.001	-	<0.001	<0.001	<0.001	<0.001	<0.001	<0.001	<0.001	-	<0.001	<0.001	<0.001	<0.001	<0.001	<0.001	<0.001	-	<0.001	<0.001	<0.001	<0.001
Boron (B)	mg/L	0.012	0.019	0.016	0.0023	0.014	0.016	0.017	0.019	<0.01	<0.01	<0.01	-	<0.01	<0.01	<0.01	<0.01	<0.01	<0.01	<0.01	-	<0.01	<0.01	<0.01	<0.01
Cadmium (Cd)	mg/L	0.00002	0.00005	0.000046	0.00001	0.00005	0.00005	0.00005	0.00005	0.00001	0.00005	0.000044	0.000014	0.00005	0.00005	0.00005	0.00005	0.00001	0.00005	0.000044	0.000014	0.00005	0.00005	0.00005	0.00005
Chromium (Cr)	mg/L	<0.003	<0.003	<0.003	-	<0.003	<0.003	<0.003	<0.003	<0.003	<0.003	<0.003	-	<0.003	<0.003	<0.003	<0.003	<0.003	<0.003	<0.003	-	<0.003	<0.003	<0.003	<0.003
Cobalt (Co)	mg/L	<0.0005	<0.0005	<0.0005	-	<0.0005	<0.0005	<0.0005	<0.0005	0.00025	0.0006	0.0003	0.00012	0.00025	0.00025	0.00025	0.0005	<0.0005	<0.0005	<0.0005	-	<0.0005	<0.0005	<0.0005	<0.0005
Copper (Cu)	mg/L	0.0007	0.001	0.00096	0.0001	0.001	0.001	0.001	0.001	0.0008	0.005	0.0015	0.0014	0.001	0.001	0.001	0.0038	<0.002	<0.002	<0.002	-	<0.002	<0.002	<0.002	<0.002
Iron (Fe)	mg/L	0.037	0.3	0.18	0.084	0.13	0.19	0.23	0.28	0.005	0.56	0.084	0.19	0.005	0.005	0.005	0.39	0.005	0.14	0.04	0.043	0.005	0.036	0.046	0.11
Lead (Pb)	mg/L	0.00005	0.0005	0.00044	0.00016	0.0005	0.0005	0.0005	0.0005	0.0001	0.0005	0.00044	0.00014	0.0005	0.0005	0.0005	0.0005	0.00005	0.0005	0.00044	0.00016	0.0005	0.0005	0.0005	0.0005
Manganese (Mn)	mg/L	0.16	0.46	0.34	0.093	0.3	0.32	0.4	0.45	0.001	0.13	0.021	0.043	0.001	0.004	0.007	0.091	0.002	0.066	0.019	0.023	0.003	0.005	0.027	0.058
Mercury (Hg)	mg/L	0.000013	0.00005	0.000043	0.000017	0.00005	0.00005	0.00005	0.00005	0.000013	0.00005	0.000043	0.000017	0.00005	0.00005	0.00005	0.00005	0.000013	0.00005	0.000043	0.000017	0.00005	0.00005	0.00005	0.00005
Molybdenum (Mo)	mg/L	0.001	0.009	0.0031	0.0029	0.001	0.001	0.0045	0.0081	<0.002	<0.002	<0.002	-	<0.002	<0.002	<0.002	<0.002	<0.002	<0.002	<0.002	-	<0.002	<0.002	<0.002	<0.002
Nickel (Ni)	mg/L	<0.003	<0.003	<0.003	-	<0.003	<0.003	<0.003	<0.003	<0.003	<0.003	<0.003	-	<0.003	<0.003	<0.003	<0.003	<0.003	<0.003	<0.003	-	<0.003	<0.003	<0.003	<0.003
Selenium (Se)	mg/L	0.0004	0.002	0.0018	0.00056	0.002	0.002	0.002	0.002	0.0001	0.002	0.0017	0.00066	0.002	0.002	0.002	0.002	0.0002	0.002	0.0017	0.00063	0.002	0.002	0.002	0.002
Silver (Ag)	mg/L	0.000005	0.00005	0.000044	0.000016	0.00005	0.00005	0.00005	0.00005	0.00005	0.0003	0.00011	0.000092	0.00005	0.00005	0.00015	0.00027	0.00002	0.00005	0.000046	0.00001	0.00005	0.00005	0.00005	0.00005
Strontium (Sr)	mg/L	0.064	0.11	0.081	0.015	0.071	0.081	0.085	0.1	0.029	0.038	0.032	0.0029	0.03	0.031	0.033	0.037	0.02	0.047	0.029	0.0088	0.023	0.025	0.032	0.044
Thallium (Tl)	mg/L	0.000005	0.00015	0.00013	0.000051	0.00015	0.00015	0.00015	0.00015	0.000005	0.00015	0.00013	0.000051	0.00015	0.00015	0.00015	0.00015	0.000005	0.00015	0.00013	0.000051	0.00015	0.00015	0.00015	0.00015
Titanium (Ti)	mg/L	0.001	0.003	0.0013	0.0007	0.001	0.001	0.001	0.0024	0.001	0.004	0.0014	0.001	0.001	0.001	0.001	0.0031	0.001	0.003	0.0013	0.0007	0.001	0.001	0.001	0.0024
Tungsten (W)	mg/L	0.005	0.027	0.01	0.0086	0.005	0.005	0.013	0.025	0.005	0.022	0.0084	0.006	0.005	0.005	0.0085	0.019	<0.01	<0.01	<0.01	-	<0.01	<0.01	<0.01	<0.01
Uranium (U)	mg/L	0.003	0.005	0.0039	0.00083	0.003	0.004	0.0045	0.005	<0.002	<0.002	<0.002	-	<0.002	<0.002	<0.002	<0.002	<0.002	<0.002	<0.002	-	<0.002	<0.002	<0.002	<0.002
Vanadium (V)	mg/L	<0.002	<0.002	<0.002	-	<0.002	<0.002	<0.002	<0.002	0.001	0.003	0.0013	0.0007	0.001	0.001	0.001	0.0024	<0.002	<0.002	<0.002	-	<0.002	<0.002	<0.002	<0.002
Zinc (Zn)	mg/L	0.0025	0.069	0.012	0.023	0.0025	0.0025	0.0038	0.05	0.0025	0.053	0.014	0.017	0.0025	0.008	0.015	0.043	0.0025	0.005	0.0029	0.00087	0.0025	0.0025	0.0025	0.0043
Zirconium (Zr)	mg/L	<0.004	<0.004	<0.004	-	<0.004	<0.004	<0.004	<0.004	<0.004	<0.004	<0.004	-	<0.004	<0.004	<0.004	<0.004	<0.004	<0.004	<0.004	-	<0.004	<0.004	<0.004	<0.004
OTHER PARAMETERS																									
Total Cyanide	mg/L	<0.002	<0.002	<0.002	-	<0.002	<0.002	<0.002	<0.002	0.001	0.007	0.0019	0.0021	0.001	0.001	0.001	0.0052	<0.002	<0.002	<0.002	-	<0.002	<0.002	<0.002	<0.002
Total Ammonia (NH ₃ + NH ₄)	mg/L as N	0.01	0.07	0.021	0.021	0.01	0.01	0.02	0.058	0.01	0.04	0.019	0.011	0.01</											

TABLE 3a
STATISTICAL SUMMARY OF UPDATED BASELINE GROUNDWATER QUALITY DATASET
CÔTÉ GOLD PROJECT

Parameter	Unit	DH12-TMF-32A (n=6)								DH12-TMF-32B (n=7)								DH12-TMF-23A (n=3)							
		Minimum	Maximum	Average	Standard Deviation	25th percentile	Median	75 th percentile	95 th percentile	Minimum	Maximum	Average	Standard Deviation	25th percentile	Median	75 th percentile	95 th percentile	Minimum	Maximum	Average	Standard Deviation	25th percentile	Median	75 th percentile	95 th percentile
GENERAL PARAMETERS																									
pH	pH units	7.30	8.10	7.80	0.26	7.70	7.90	8.00	8.00	6.50	7.60	7.20	0.40	6.90	7.50	7.50	7.50	7.80	8.00	7.90	0.09	7.80	7.90	7.90	8.00
Alkalinity	mg/L as CaCO ₃	120	140	130	5.3	130	130	140	140	43	65	53	7.1	49	54	57	63	73	100	83	13	74	74	88	99
Electrical Conductivity (EC)	µS/cm	300	320	310	8.4	300	300	310	320	110	150	130	13	120	130	130	140	180	260	220	35	190	210	240	260
Total Dissolved Solids (TDS)	mg/L	170	210	190	17	180	190	200	210	74	94	84	7.9	76	86	91	93	110	180	140	29	120	120	150	170
Total Suspended Solids (TSS)	mg/L as CaCO ₃	50	1100	420	450	96	140	750	1100	670	4500	1700	1300	750	930	2100	4000	170	420	290	100	230	290	350	400
Total Hardness	mg/L as CaCO ₃	130	140	140	4	140	140	140	140	51	47000	6800	17000	55	61	69	33000	76	76000	25000	36000	77	77	38000	69000
MAJOR IONS																									
Calcium (Ca)	mg/L	42	46	45	1.5	45	45	45	46	18	26	22	2.9	20	21	24	26	22	23	22	0.24	22	22	22	23
Magnesium (Mg)	mg/L	5.8	6.4	6.2	0.24	6	6.2	6.4	6.4	0.85	1.3	1	0.16	0.9	0.99	1.2	1.3	4.9	5.2	5	0.12	5	5	5.1	5.2
Potassium (K)	mg/L	1.1	1.8	1.4	0.24	1.2	1.4	1.5	1.7	0.24	0.46	0.37	0.067	0.35	0.38	0.41	0.45	1.1	1.3	1.2	0.093	1.2	1.3	1.3	1.3
Sodium (Na)	mg/L	8.1	14	10	2	8.5	9.2	11	13	0.99	1.6	1.3	0.16	1.2	1.3	1.3	1.5	5.4	11	8.1	2.4	6.5	7.7	9.4	11
Chloride (Cl)	mg/L	0.68	1.3	0.91	0.23	0.74	0.8	1.1	1.3	0.36	0.54	0.46	0.067	0.42	0.43	0.53	0.54	2.7	3.6	3.3	0.38	3.1	3.4	3.5	3.6
Fluoride (F)	mg/L	0.35	0.48	0.4	0.041	0.38	0.39	0.41	0.47	<0.05	<0.05	<0.05	-	<0.05	<0.05	<0.05	<0.05	0.14	0.16	0.15	0.0094	0.15	0.16	0.16	0.16
Sulphate (SO ₄)	mg/L	22	27	23	1.9	22	22	24	26	5.4	7.5	6.3	0.63	6	6.1	6.7	7.2	7.5	15	11	3.2	9.6	12	14	15
METALS																									
Aluminum (Al)	mg/L	0.006	0.037	0.019	0.014	0.006	0.014	0.032	0.037	0.002	0.18	0.034	0.06	0.004	0.006	0.02	0.14	0.011	0.029	0.02	0.0074	0.016	0.021	0.025	0.028
Antimony (Sb)	mg/L	0.003	0.006	0.0035	0.0011	0.003	0.003	0.003	0.0053	<0.006	<0.006	<0.006	-	<0.006	<0.006	<0.006	<0.006	<0.006	<0.006	<0.006	-	<0.006	<0.006	<0.006	<0.006
Arsenic (As)	mg/L	0.016	0.23	0.18	0.073	0.19	0.21	0.21	0.23	0.0015	0.05	0.0084	0.017	0.0015	0.0015	0.0015	0.035	0.0015	0.05	0.018	0.023	0.0015	0.0015	0.026	0.045
Barium (Ba)	mg/L	0.02	0.034	0.028	0.0047	0.024	0.029	0.031	0.033	0.001	0.005	0.0029	0.0011	0.0025	0.003	0.0044	0.008	0.008	0.027	0.018	0.0078	0.014	0.019	0.023	0.026
Beryllium (Be)	mg/L	<0.001	<0.001	<0.001	-	<0.001	<0.001	<0.001	<0.001	<0.001	<0.001	<0.001	-	<0.001	<0.001	<0.001	<0.001	<0.001	<0.001	<0.001	-	<0.001	<0.001	<0.001	<0.001
Boron (B)	mg/L	0.1	0.15	0.12	0.017	0.11	0.11	0.14	0.15	<0.01	<0.01	<0.01	-	<0.01	<0.01	<0.01	<0.01	0.012	0.018	0.015	0.0025	0.013	0.014	0.016	0.018
Cadmium (Cd)	mg/L	0.00001	0.0001	0.000052	0.000026	0.00005	0.00005	0.00005	0.000088	0.00001	0.0002	0.000066	0.000057	0.00005	0.00005	0.00005	0.00016	0.00001	0.00005	0.000037	0.000019	0.00003	0.00005	0.00005	0.00005
Chromium (Cr)	mg/L	<0.003	<0.003	<0.003	-	<0.003	<0.003	<0.003	<0.003	<0.003	<0.003	<0.003	<0.003	<0.003	<0.003	<0.003	<0.003	<0.003	<0.003	<0.003	-	<0.003	<0.003	<0.003	<0.003
Cobalt (Co)	mg/L	0.00025	0.0005	0.00029	0.000093	0.00025	0.00025	0.00025	0.00044	<0.0005	<0.0005	<0.0005	-	<0.0005	<0.0005	<0.0005	<0.0005	<0.0005	<0.0005	<0.0005	-	<0.0005	<0.0005	<0.0005	<0.0005
Copper (Cu)	mg/L	0.001	0.0012	0.001	0.000075	0.001	0.001	0.001	0.0012	0.001	0.015	0.0033	0.0048	0.001	0.001	0.0021	0.011	0.0002	0.001	0.00073	0.00038	0.0006	0.001	0.001	0.001
Iron (Fe)	mg/L	<0.01	<0.01	<0.01	-	<0.01	<0.01	<0.01	<0.01	0.005	0.018	0.0076	0.0046	0.005	0.005	0.0075	0.016	0.005	0.14	0.05	0.064	0.005	0.005	0.073	0.13
Lead (Pb)	mg/L	0.00005	0.0005	0.00043	0.00017	0.0005	0.0005	0.0005	0.0005	0.0001	0.0005	0.00044	0.00014	0.0005	0.0005	0.0005	0.0005	0.00005	0.0005	0.00035	0.00021	0.00028	0.0005	0.0005	0.0005
Manganese (Mn)	mg/L	0.001	0.13	0.025	0.047	0.001	0.002	0.012	0.1	0.001	0.12	0.037	0.042	0.003	0.008	0.063	0.1	0.092	0.16	0.12	0.026	0.11	0.12	0.14	0.15
Mercury (Hg)	mg/L	0.0000013	0.00005	0.000042	0.000018	0.00005	0.00005	0.00005	0.00005	0.0000013	0.00005	0.000043	0.000017	0.00005	0.00005	0.00005	0.00005	0.0000013	0.00005	0.000034	0.000023	0.000026	0.00005	0.00005	0.00005
Molybdenum (Mo)	mg/L	0.012	0.018	0.015	0.0018	0.015	0.016	0.016	0.018	<0.002	<0.002	<0.002	-	<0.002	<0.002	<0.002	<0.002	0.001	0.002	0.0013	0.00047	0.001	0.001	0.0015	0.0019
Nickel (Ni)	mg/L	<0.003	<0.003	<0.003	-	<0.003	<0.003	<0.003	<0.003	<0.003	<0.003	<0.003	-	<0.003	<0.003	<0.003	<0.003	<0.003	<0.003	<0.003	-	<0.003	<0.003	<0.003	<0.003
Selenium (Se)	mg/L	0.0002	0.002	0.0017	0.00067	0.002	0.002	0.002	0.002	0.002	0.05	0.0089	0.017	0.002	0.002	0.002	0.036	0.002	0.05	0.018	0.023	0.002	0.002	0.026	0.045
Silver (Ag)	mg/L	0.000005	0.00005	0.000043	0.000017	0.00005	0.00005	0.00005	0.00005	0.00002	0.00005	0.000046	0.00001	0.00005	0.00005	0.00005	0.00005	0.000005	0.00005	0.000035	0.000021	0.000028	0.00005	0.00005	0.00005
Strontium (Sr)	mg/L	0.11	0.13	0.12	0.009	0.12	0.12	0.12	0.13	0.022	0.036	0.029	0.0046	0.025	0.029	0.032	0.035	0.11	0.16	0.14	0.022	0.12	0.13	0.15	0.16
Thallium (Tl)	mg/L	0.000005	0.00015	0.00013	0.000054	0.00015	0.00015	0.00015	0.00015	0.000005	0.00015	0.00013	0.000051	0.00015	0.00015	0.00015	0.00015	0.000005	0.00015	0.0001	0.000068	0.000078	0.00015	0.00015	0.00015
Titanium (Ti)	mg/L	<0.002	<0.002	<0.002	-	<0.002	<0.002	<0.002	<0.002	<0.002	<0.002	<0.002	-	<0.002	<0.002	<0.002	<0.002	<0.002	<0.002	<0.002	-	<0.002	<0.002	<0.002	<0.002
Tungsten (W)	mg/L	0.005	0.031	0.0093	0.0097	0.005	0.005	0.005	0.025	<0.01	<0.01	<0.01	<0.01	<0.01	<0.01	<0.01	<0.01	0.005	0.015	0.01	0.0041	0.0075	0.01	0.013	0.015
Uranium (U)	mg/L	<0.002	<0.002	<0.002	-	<0.002	<0.002	<0.002	<0.002	<0.002	<0.002	<0.002	-	<0.002	<0.002	<0.002	<0.002	0.009	0.021	0.016	0.0052	0.014	0.019	0.02	0.021
Vanadium (V)	mg/L	<0.002	<0.002	<0.002	-	<0.002	<0.002	<0.002	<0.002	<0.002	<0.002	<0.002	-	<0.002	<0.002	<0.002	<0.002	<0.002	<0.002	<0.002	-	<0.002	<0.002	<0.002	<0.002
Zinc (Zn)	mg/L	0.0025	0.028	0.0093	0.0089	0.0031	0.0055	0.011	0.024	0.0025	0.32	0.054	0.11	0.0025	0.0025	0.027	0.24	0.0025	0.036	0.014	0.016	0.0025	0.0025	0.019	0.033
Zirconium (Zr)	mg/L	<0.004	<0.004	<0.004	-	<0.004	<0.004	<0.004	<0.004	<0.004	<0.004	<0.004	-	<0.004	<0.004	<0.004	<0.004	<0.004	<0.004	<0.004	-	<0.004	<0.004	<0.004	<0.004
OTHER PARAMETERS																									
Total Cyanide	mg/L	0.001	0.003	0.0013	0.00075	0.001	0.001	0.001	0.0025	0.001	0.012	0.0026	0.0038	0.001	0.001	0.001	0.0087	0.001	<0.002	<0.002	-	<0.002	<0.002	<0.002	<0.002
Total Ammonia (NH ₃ + NH ₄)	mg/L as N	0.01	0.33	0.087	0.11	0.018	0.05	0.068	0.27	0.01	0.03	0.014	0.0073	0.01	0										

TABLE 3a
STATISTICAL SUMMARY OF UPDATED BASELINE GROUNDWATER QUALITY DATASET
CÔTÉ GOLD PROJECT

Parameter	Unit	DH12-TMF-23B (n=4)								DH12-TMF-24A (n=3)								DH12-TMF-24B (n=3)							
		Minimum	Maximum	Average	Standard Deviation	25th percentile	Median	75 th percentile	95 th percentile	Minimum	Maximum	Average	Standard Deviation	25th percentile	Median	75 th percentile	95 th percentile	Minimum	Maximum	Average	Standard Deviation	25th percentile	Median	75 th percentile	95 th percentile
GENERAL PARAMETERS																									
pH	pH units	7.50	8.00	7.70	0.19	7.60	7.70	7.80	8.00	7.30	7.90	7.60	0.23	7.50	7.70	7.80	7.90	6.70	7.00	6.80	0.11	6.70	6.80	6.90	6.90
Alkalinity	mg/L as CaCO ₃	48	58	53	3.6	51	53	54	57	130	210	180	36	160	200	200	210	17	21	20	1.9	19	21	21	21
Electrical Conductivity (EC)	µS/cm	110	120	120	3	120	120	120	120	520	720	650	89	610	700	710	720	51	58	54	2.9	53	54	56	58
Total Dissolved Solids (TDS)	mg/L	68	110	92	17	83	93	100	110	370	560	460	77	410	450	510	550	76	160	130	40	120	160	160	160
Total Suspended Solids (TSS)	mg/L as CaCO ₃	1100	6800	2700	2400	1400	1500	2900	6000	950	1800	1400	340	1200	1500	1600	1700	4500	26000	12000	9800	5500	6400	16000	24000
Total Hardness	mg/L as CaCO ₃	50	55000	14000	24000	52	56	14000	46000	180	270	210	42	180	180	220	260	16	20	19	2	18	20	20	20
MAJOR IONS																									
Calcium (Ca)	mg/L	16	19	17	1	17	17	18	19	61	92	72	14	61	62	77	89	4.3	5.5	5.1	0.56	4.9	5.5	5.5	5.5
Magnesium (Mg)	mg/L	2.4	3	2.7	0.22	2.4	2.6	2.8	2.9	5.2	9.1	6.9	1.6	5.8	6.4	7.8	8.8	1.3	1.6	1.5	0.13	1.4	1.6	1.6	1.6
Potassium (K)	mg/L	0.17	0.66	0.35	0.18	0.25	0.29	0.39	0.61	2.9	3.4	3.1	0.26	2.9	2.9	3.2	3.4	0.58	0.74	0.64	0.071	0.59	0.6	0.67	0.73
Sodium (Na)	mg/L	1.3	4.8	2.8	1.3	2	2.5	3.2	4.5	36	86	53	23	37	38	62	81	1.9	1.9	1.9	0.026	1.9	1.9	1.9	1.9
Chloride (Cl)	mg/L	0.24	0.47	0.39	0.092	0.35	0.43	0.46	0.47	57	75	64	8.2	58	60	67	74	0.46	0.9	0.73	0.19	0.65	0.83	0.87	0.89
Fluoride (F)	mg/L	0.025	0.12	0.049	0.041	0.025	0.025	0.049	0.11	<0.05	<0.05	<0.05	-	<0.05	<0.05	<0.05	<0.05	<0.05	<0.05	<0.05	-	<0.05	<0.05	<0.05	<0.05
Sulphate (SO ₄)	mg/L	3.6	5.2	4.2	0.63	3.7	4	4.5	5.1	18	56	33	16	22	27	41	53	2.5	3.1	2.8	0.25	2.6	2.7	2.9	3.1
METALS																									
Aluminum (Al)	mg/L	0.007	0.068	0.028	0.024	0.011	0.019	0.036	0.062	0.04	0.11	0.064	0.03	0.044	0.047	0.077	0.1	0.13	0.16	0.15	0.011	0.14	0.15	0.16	0.16
Antimony (Sb)	mg/L	<0.006	<0.006	<0.006	-	<0.006	<0.006	<0.006	<0.006	<0.006	<0.006	<0.006	-	<0.006	<0.006	<0.006	<0.006	<0.006	<0.006	<0.006	-	<0.006	<0.006	<0.006	<0.006
Arsenic (As)	mg/L	0.0015	0.05	0.014	0.021	0.0015	0.0015	0.014	0.043	0.0015	0.004	0.0023	0.0012	0.0015	0.0015	0.0028	0.0038	<0.003	<0.003	<0.003	-	<0.003	<0.003	<0.003	<0.003
Barium (Ba)	mg/L	0.003	0.005	0.004	0.00071	0.0038	0.004	0.0043	0.0049	0.063	0.14	0.093	0.032	0.071	0.078	0.11	0.13	0.008	0.009	0.0087	0.00047	0.0085	0.009	0.009	0.009
Beryllium (Be)	mg/L	<0.001	<0.001	<0.001	-	<0.001	<0.001	<0.001	<0.001	<0.001	<0.001	<0.001	-	<0.001	<0.001	<0.001	<0.001	<0.001	<0.001	<0.001	-	<0.001	<0.001	<0.001	<0.001
Boron (B)	mg/L	<0.01	<0.01	<0.01	-	<0.01	<0.01	<0.01	<0.01	0.069	0.22	0.12	0.069	0.074	0.078	0.15	0.2	<0.01	<0.01	<0.01	-	<0.01	<0.01	<0.01	<0.01
Cadmium (Cd)	mg/L	0.00001	0.00005	0.00004	0.000017	0.00004	0.00005	0.00005	0.00005	<0.0001	<0.0001	<0.0001	-	<0.0001	<0.0001	<0.0001	<0.0001	<0.0001	<0.0001	<0.0001	-	<0.0001	<0.0001	<0.0001	<0.0001
Chromium (Cr)	mg/L	<0.003	<0.003	<0.003	-	<0.003	<0.003	<0.003	<0.003	<0.003	<0.003	<0.003	-	<0.003	<0.003	<0.003	<0.003	<0.003	<0.003	<0.003	-	<0.003	<0.003	<0.003	<0.003
Cobalt (Co)	mg/L	<0.0005	<0.0005	<0.0005	-	<0.0005	<0.0005	<0.0005	<0.0005	0.00025	0.0026	0.0012	0.001	0.00053	0.0008	0.0017	0.0024	0.0005	0.0007	0.0006	0.000082	0.00055	0.0006	0.00065	0.00069
Copper (Cu)	mg/L	0.0005	0.001	0.00088	0.00022	0.00088	0.001	0.001	0.001	<0.002	<0.002	<0.002	-	<0.002	<0.002	<0.002	<0.002	<0.002	<0.002	<0.002	-	<0.002	<0.002	<0.002	<0.002
Iron (Fe)	mg/L	0.005	0.013	0.007	0.0035	0.005	0.005	0.007	0.012	0.55	2	1.1	0.61	0.68	0.82	1.4	1.8	5.6	7.8	7	1	6.7	7.7	7.8	7.8
Lead (Pb)	mg/L	0.00005	0.0005	0.00039	0.00019	0.00039	0.0005	0.0005	0.0005	<0.001	<0.001	<0.001	-	<0.001	<0.001	<0.001	<0.001	<0.001	<0.001	<0.001	-	<0.001	<0.001	<0.001	<0.001
Manganese (Mn)	mg/L	0.001	0.025	0.012	0.0093	0.004	0.01	0.018	0.024	0.3	0.49	0.39	0.078	0.34	0.39	0.44	0.48	0.13	0.15	0.13	0.0087	0.13	0.13	0.14	0.14
Mercury (Hg)	mg/L	0.000013	0.00005	0.000038	0.000021	0.000038	0.00005	0.00005	0.00005	<0.0001	<0.0001	<0.0001	-	<0.0001	<0.0001	<0.0001	<0.0001	<0.0001	<0.0001	<0.0001	-	<0.0001	<0.0001	<0.0001	<0.0001
Molybdenum (Mo)	mg/L	<0.002	<0.002	<0.002	-	<0.002	<0.002	<0.002	<0.002	0.001	0.003	0.0023	0.00094	0.002	0.003	0.003	0.003	<0.002	<0.002	<0.002	-	<0.002	<0.002	<0.002	<0.002
Nickel (Ni)	mg/L	<0.003	<0.003	<0.003	-	<0.003	<0.003	<0.003	<0.003	0.0015	0.011	0.0058	0.0039	0.0033	0.005	0.008	0.01	<0.003	<0.003	<0.003	-	<0.003	<0.003	<0.003	<0.003
Selenium (Se)	mg/L	0.002	0.05	0.014	0.021	0.002	0.002	0.014	0.043	<0.004	<0.004	<0.004	-	<0.004	<0.004	<0.004	<0.004	<0.004	<0.004	<0.004	-	<0.004	<0.004	<0.004	<0.004
Silver (Ag)	mg/L	0.000005	0.00005	0.000039	0.000019	0.000039	0.00005	0.00005	0.00005	<0.0001	<0.0001	<0.0001	-	<0.0001	<0.0001	<0.0001	<0.0001	0.00005	0.0001	0.000067	0.000024	0.00005	0.00005	0.000075	0.000095
Strontium (Sr)	mg/L	0.021	0.026	0.023	0.0019	0.022	0.023	0.025	0.026	0.87	1	0.92	0.058	0.88	0.89	0.94	0.99	0.035	0.038	0.036	0.0012	0.036	0.036	0.037	0.038
Thallium (Tl)	mg/L	0.00002	0.00015	0.00012	0.000056	0.00012	0.00015	0.00015	0.00015	<0.0003	<0.0003	<0.0003	-	<0.0003	<0.0003	<0.0003	<0.0003	<0.0003	<0.0003	<0.0003	-	<0.0003	<0.0003	<0.0003	<0.0003
Titanium (Ti)	mg/L	<0.002	<0.002	<0.002	-	<0.002	<0.002	<0.002	<0.002	<0.002	<0.002	<0.002	-	<0.002	<0.002	<0.002	<0.002	0.004	0.009	0.0057	0.0024	0.004	0.004	0.0065	0.0085
Tungsten (W)	mg/L	<0.01	<0.01	<0.01	-	<0.01	<0.01	<0.01	<0.01	0.005	0.013	0.0077	0.0038	0.005	0.005	0.009	0.012	<0.01	<0.01	<0.01	-	<0.01	<0.01	<0.01	<0.01
Uranium (U)	mg/L	<0.002	<0.002	<0.002	-	<0.002	<0.002	<0.002	<0.002	0.001	0.005	0.0023	0.0019	0.001	0.001	0.003	0.0046	<0.002	<0.002	<0.002	-	<0.002	<0.002	<0.002	<0.002
Vanadium (V)	mg/L	<0.002	<0.002	<0.002	-	<0.002	<0.002	<0.002	<0.002	0.001	0.002	0.0013	0.00047	0.001	0.001	0.0015	0.0019	0.006	0.018	0.013	0.0052	0.011	0.016	0.017	0.018
Zinc (Zn)	mg/L	0.0025	0.11	0.038	0.043	0.0025	0.02	0.056	0.098	0.0025	0.45	0.15	0.21	0.0025	0.0025	0.22	0.4	0.005	0.081	0.033	0.034	0.0095	0.014	0.048	0.074
Zirconium (Zr)	mg/L	<0.004	<0.004	<0.004	-	<0.004	<0.004	<0.004	<0.004	<0.004	<0.004	<0.004	-	<0.004	<0.004	<0.004	<0.004	<0.004	<0.004	<0.004	-	<0.004	<0.004	<0.004	<0.004
OTHER PARAMETERS																									
Total Cyanide	mg/L	0.001	0.009	0.003	0.0035	0.001	0.001	0.003	0.0078	<0.002	<0.002	<0.002	-	<0.002	<0.002	<0.002	<0.002	0.001	0.002	0.0013	0.00047	0.001	0.001	0.0015	0.0019
Total Ammonia (NH ₃ + NH ₄)	mg/L as N	0.01	0.01	0.01	0.00087	0.01	0.01	0.01	0.01	0.01	0.04	0.027	0.012	0.02	0.03	0.035	0.03								

TABLE 3a
STATISTICAL SUMMARY OF UPDATED BASELINE GROUNDWATER QUALITY DATASET
CÔTÉ GOLD PROJECT

Parameter	Unit	DH12-WD-01 (n=6)								DH12-WD-12A (n=6)								DH12-WD-12B (n=6)							
		Minimum	Maximum	Average	Standard Deviation	25th percentile	Median	75 th percentile	95 th percentile	Minimum	Maximum	Average	Standard Deviation	25th percentile	Median	75 th percentile	95 th percentile	Minimum	Maximum	Average	Standard Deviation	25th percentile	Median	75 th percentile	95 th percentile
GENERAL PARAMETERS																									
pH	pH units	6.50	7.40	7.00	0.35	6.80	7.00	7.30	7.40	7.40	8.10	7.90	0.21	7.80	7.90	8.00	8.00	7.60	8.20	7.90	0.19	7.80	8.00	8.10	8.10
Alkalinity	mg/L as CaCO ₃	30	74	53	18	35	57	68	73	120	160	140	13	130	130	140	150	120	150	130	10	120	130	130	150
Electrical Conductivity (EC)	µS/cm	87	160	130	28	99	130	140	160	270	510	350	84	280	340	390	480	240	300	270	18	250	270	280	290
Total Dissolved Solids (TDS)	mg/L	52	110	93	20	91	100	110	110	150	720	310	200	170	210	340	640	150	180	160	13	150	160	170	180
Total Suspended Solids (TSS)	mg/L as CaCO ₃	38	1400	480	430	200	370	560	1200	82	13000	2400	4800	120	220	580	9900	13	100	36	30	17	23	37	85
Total Hardness	mg/L as CaCO ₃	33	71	51	16	37	50	64	69	120	150	140	7.6	130	130	140	150	100	140	130	11	130	130	130	140
MAJOR IONS																									
Calcium (Ca)	mg/L	11	23	17	5	12	17	22	23	39	47	43	2.5	42	43	44	46	32	43	40	3.4	40	40	42	43
Magnesium (Mg)	mg/L	1.2	3.2	2.1	0.79	1.4	1.9	2.8	3.1	6.3	7.4	6.7	0.36	6.5	6.6	6.9	7.3	5.6	7.5	6.8	0.62	6.8	6.9	7.1	7.4
Potassium (K)	mg/L	0.45	0.99	0.71	0.2	0.53	0.72	0.85	0.96	1.1	1.6	1.3	0.17	1.2	1.3	1.4	1.5	1.5	1.7	1.6	0.054	1.6	1.6	1.6	1.7
Sodium (Na)	mg/L	1.7	4.9	3	1.2	2	2.9	3.7	4.6	3.1	55	20	19	4.5	17	27	48	3.1	4.6	3.8	0.63	3.3	3.5	4.4	4.6
Chloride (Cl)	mg/L	0.38	1.4	0.72	0.33	0.49	0.66	0.79	1.2	0.61	5.4	2.2	1.8	0.66	1.2	3.4	5	0.68	0.9	0.77	0.088	0.69	0.74	0.85	0.89
Fluoride (F)	mg/L	0.025	0.15	0.062	0.053	0.025	0.025	0.096	0.14	0.025	0.07	0.033	0.017	0.025	0.025	0.059	0.025	0.14	0.061	0.051	0.025	0.025	0.1	0.14	
Sulphate (SO ₄)	mg/L	9.3	11	10	0.62	9.4	9.9	10	11	7.1	120	41	41	7.7	25	56	110	6.4	14	9.2	2.3	7.6	9	10	13
METALS																									
Aluminum (Al)	mg/L	0.024	0.12	0.052	0.033	0.033	0.042	0.048	0.1	0.002	0.18	0.036	0.065	0.0053	0.0075	0.012	0.14	0.005	0.021	0.011	0.0057	0.0058	0.009	0.014	0.02
Antimony (Sb)	mg/L	<0.006	<0.006	<0.006	-	<0.006	<0.006	<0.006	<0.006	<0.006	<0.006	<0.006	-	<0.006	<0.006	<0.006	<0.006	<0.006	<0.006	<0.006	-	<0.006	<0.006	<0.006	<0.006
Arsenic (As)	mg/L	<0.003	<0.003	<0.003	-	<0.003	<0.003	<0.003	<0.003	0.0015	0.05	0.0096	0.018	0.0015	0.0015	0.038	0.0015	0.05	0.0096	0.018	0.0015	0.0015	0.0015	0.0015	0.038
Barium (Ba)	mg/L	0.004	0.023	0.0088	0.0065	0.0053	0.0065	0.0078	0.019	0.01	0.017	0.013	0.0025	0.011	0.012	0.014	0.017	0.012	0.014	0.013	0.0009	0.012	0.013	0.014	0.014
Beryllium (Be)	mg/L	<0.001	<0.001	<0.001	-	<0.001	<0.001	<0.001	<0.001	<0.001	<0.001	<0.001	-	<0.001	<0.001	<0.001	<0.001	<0.001	<0.001	<0.001	-	<0.001	<0.001	<0.001	<0.001
Boron (B)	mg/L	<0.01	<0.01	<0.01	-	<0.01	<0.01	<0.01	<0.01	<0.01	<0.01	<0.01	-	<0.01	<0.01	<0.01	<0.01	<0.01	<0.01	<0.01	-	<0.01	<0.01	<0.01	<0.01
Cadmium (Cd)	mg/L	0.00005	0.0002	0.000075	0.000056	0.00005	0.00005	0.00005	0.00016	0.00001	0.00005	0.000043	0.000015	0.00005	0.00005	0.00005	0.00005	0.00001	0.00005	0.000043	0.000015	0.00005	0.00005	0.00005	0.00005
Chromium (Cr)	mg/L	<0.003	<0.003	<0.003	-	<0.003	<0.003	<0.003	<0.003	<0.003	<0.003	<0.003	-	<0.003	<0.003	<0.003	<0.003	<0.003	<0.003	<0.003	-	<0.003	<0.003	<0.003	<0.003
Cobalt (Co)	mg/L	0.00025	0.0015	0.00072	0.00042	0.00036	0.00075	0.0008	0.0013	<0.0005	<0.0005	<0.0005	-	<0.0005	<0.0005	<0.0005	<0.0005	<0.0005	<0.0005	<0.0005	-	<0.0005	<0.0005	<0.0005	<0.0005
Copper (Cu)	mg/L	0.003	0.009	0.0058	0.002	0.0045	0.006	0.0068	0.0085	<0.002	<0.002	<0.002	-	<0.002	<0.002	<0.002	<0.002	0.0009	0.002	0.0012	0.00038	0.001	0.001	0.001	0.0018
Iron (Fe)	mg/L	0.005	0.84	0.16	0.3	0.014	0.028	0.042	0.64	0.005	0.26	0.079	0.089	0.015	0.036	0.11	0.22	0.026	0.079	0.05	0.017	0.036	0.052	0.057	0.074
Lead (Pb)	mg/L	<0.001	<0.001	<0.001	-	<0.001	<0.001	<0.001	<0.001	0.00005	0.0005	0.00043	0.00017	0.0005	0.0005	0.0005	0.0005	0.00005	0.0005	0.00043	0.00017	0.0005	0.0005	0.0005	0.0005
Manganese (Mn)	mg/L	0.021	0.3	0.1	0.099	0.04	0.051	0.13	0.27	0.012	0.021	0.017	0.0028	0.016	0.018	0.019	0.021	0.037	0.061	0.046	0.0097	0.038	0.043	0.055	0.06
Mercury (Hg)	mg/L	<0.0001	<0.0001	<0.0001	-	<0.0001	<0.0001	<0.0001	<0.0001	0.0000013	0.00005	0.000042	0.000018	0.00005	0.00005	0.00005	0.00005	0.0000013	0.00005	0.000042	0.000018	0.00005	0.00005	0.00005	0.00005
Molybdenum (Mo)	mg/L	0.001	0.033	0.0063	0.012	0.001	0.001	0.001	0.025	<0.002	<0.002	<0.002	-	<0.002	<0.002	<0.002	<0.002	0.001	0.003	0.0015	0.00076	0.001	0.001	0.0018	0.0028
Nickel (Ni)	mg/L	0.0015	0.005	0.0021	0.0013	0.0015	0.0015	0.0015	0.0041	<0.003	<0.003	<0.003	-	<0.003	<0.003	<0.003	<0.003	<0.003	<0.003	<0.003	-	<0.003	<0.003	<0.003	<0.003
Selenium (Se)	mg/L	<0.004	<0.004	<0.004	-	<0.004	<0.004	<0.004	<0.004	0.002	0.05	0.01	0.018	0.002	0.002	0.038	0.002	0.05	0.01	0.018	0.002	0.002	0.002	0.002	0.038
Silver (Ag)	mg/L	<0.0001	<0.0001	<0.0001	-	<0.0001	<0.0001	<0.0001	<0.0001	0.00001	0.00005	0.000043	0.000015	0.00005	0.00005	0.00005	0.00005	<0.0001	<0.0001	<0.0001	-	<0.0001	<0.0001	<0.0001	<0.0001
Strontium (Sr)	mg/L	0.023	0.08	0.04	0.02	0.026	0.031	0.044	0.072	0.065	0.1	0.078	0.013	0.067	0.076	0.085	0.098	0.047	0.058	0.053	0.0038	0.051	0.053	0.056	0.058
Thallium (Tl)	mg/L	<0.0003	<0.0003	<0.0003	-	<0.0003	<0.0003	<0.0003	<0.0003	0.000005	0.00015	0.00013	0.000054	0.00015	0.00015	0.00015	0.00015	0.000005	0.00015	0.00013	0.000054	0.00015	0.00015	0.00015	0.00015
Titanium (Ti)	mg/L	<0.002	<0.002	<0.002	-	<0.002	<0.002	<0.002	<0.002	<0.002	<0.002	<0.002	-	<0.002	<0.002	<0.002	<0.002	<0.002	<0.002	<0.002	-	<0.002	<0.002	<0.002	<0.002
Tungsten (W)	mg/L	0.005	0.11	0.027	0.036	0.0063	0.01	0.021	0.087	0.005	0.026	0.011	0.0075	0.005	0.0075	0.012	0.023	0.053	0.43	0.16	0.14	0.072	0.092	0.22	0.38
Uranium (U)	mg/L	<0.002	<0.002	<0.002	-	<0.002	<0.002	<0.002	<0.002	0.002	0.003	0.0022	0.00037	0.002	0.002	0.002	0.0028	<0.006	<0.006	<0.006	-	<0.006	<0.006	<0.006	<0.006
Vanadium (V)	mg/L	0.001	0.002	0.0012	0.00037	0.001	0.001	0.001	0.0018	<0.002	<0.002	<0.002	-	<0.002	<0.002	<0.002	<0.002	<0.002	<0.002	<0.002	-	<0.002	<0.002	<0.002	<0.002
Zinc (Zn)	mg/L	0.0025	0.86	0.15	0.32	0.0025	0.0025	0.0074	0.65	0.0025	0.039	0.0092	0.013	0.0025	0.0025	0.0051	0.031	0.0025	0.027	0.014	0.0087	0.0085	0.012	0.022	0.026
Zirconium (Zr)	mg/L	<0.004	<0.004	<0.004	-	<0.004	<0.004	<0.004	<0.004	<0.004	<0.004	<0.004	-	<0.004	<0.004	<0.004	<0.004	<0.004	<0.004	<0.004	-	<0.004	<0.004	<0.004	<0.004
OTHER PARAMETERS																									
Total Cyanide	mg/L	0.001	0.012	0.0028	0.0041	0.001	0.001	0.001	0.0093	<0.002	<0.002	<0.002	-	<0.002	<0.002	<0.002	<0.002	<0.002	<0.002	<0.002	-	<0.002	<0.002	<0.002	<0.002
Total Ammonia (NH ₃ + NH ₄)	mg/L as N	0.01	0.1	0.025	0.034	0.01	0.01	0.01	0.078	0.01	0.11	0.042	0.045	0.01	0.01	0.078</									

TABLE 3a
STATISTICAL SUMMARY OF UPDATED BASELINE GROUNDWATER QUALITY DATASET
CÔTÉ GOLD PROJECT

Parameter	Unit	DH12-WD-14 (n=7)								DH12-WD-17A (n=7)								DH12-WD-19 (n=3)							
		Minimum	Maximum	Average	Standard Deviation	25th percentile	Median	75 th percentile	95 th percentile	Minimum	Maximum	Average	Standard Deviation	25th percentile	Median	75 th percentile	95 th percentile	Minimum	Maximum	Average	Standard Deviation	25th percentile	Median	75 th percentile	95 th percentile
GENERAL PARAMETERS																									
pH	pH units	7.20	8.00	7.70	0.26	7.70	7.80	7.90	8.00	7.70	8.10	7.90	0.11	7.90	8.00	8.00	8.10	7.90	8.10	8.00	0.07	8.00	8.00	8.00	8.10
Alkalinity	mg/L as CaCO ₃	92	110	100	7.6	97	100	110	110	110	150	130	14	120	130	150	200	210	210	6.3	200	210	210	210	
Electrical Conductivity (EC)	µS/cm	220	240	220	9.2	220	220	230	240	300	420	350	39	310	360	360	400	380	430	410	21	390	410	420	430
Total Dissolved Solids (TDS)	mg/L	120	160	130	13	130	130	130	150	150	290	220	41	210	220	230	280	240	540	340	140	240	240	390	510
Total Suspended Solids (TSS)	mg/L as CaCO ₃	110	770	330	200	230	260	360	670	38	590	150	180	47	72	130	460	190	790	420	270	230	270	530	740
Total Hardness	mg/L as CaCO ₃	96	100	99	2.5	98	99	100	100	93	110	100	4.2	100	100	100	110	190	210	200	7.8	200	210	210	210
MAJOR IONS																									
Calcium (Ca)	mg/L	31	34	32	0.86	32	32	32	33	29	33	31	1.1	30	31	32	32	62	66	65	1.8	64	66	66	66
Magnesium (Mg)	mg/L	4.5	4.9	4.7	0.16	4.5	4.6	4.8	4.9	4.9	6.4	5.9	0.49	5.7	6.1	6.2	6.4	8.2	10	9.3	0.77	9	9.7	9.9	10
Potassium (K)	mg/L	1.1	1.6	1.2	0.17	1.1	1.2	1.3	1.5	1	1.4	1.1	0.11	1.1	1.1	1.1	1.3	1.7	1.8	1.7	0.049	1.7	1.7	1.7	1.8
Sodium (Na)	mg/L	6	7.8	6.6	0.6	6.2	6.3	6.9	7.6	25	39	33	5.1	30	35	37	39	3.9	25	11	9.6	4.3	4.7	15	23
Chloride (Cl)	mg/L	0.9	1.1	0.97	0.055	0.94	0.94	1	1.1	11	22	18	3.9	16	19	21	21	0.96	3.3	2	0.94	1.4	1.9	2.6	3.1
Fluoride (F)	mg/L	0.025	0.17	0.1	0.054	0.063	0.12	0.15	0.16	0.025	0.07	0.031	0.016	0.025	0.025	0.057	<0.05	<0.05	<0.05	-	<0.05	<0.05	<0.05	<0.05	
Sulphate (SO ₄)	mg/L	9.8	11	10	0.38	10	10	10	11	15	33	23	5.5	20	24	27	31	11	29	18	8.1	12	12	21	27
METALS																									
Aluminum (Al)	mg/L	0.002	0.013	0.0076	0.0039	0.0045	0.009	0.01	0.012	0.004	0.063	0.025	0.022	0.007	0.013	0.039	0.06	0.013	0.018	0.015	0.0022	0.014	0.014	0.016	0.018
Antimony (Sb)	mg/L	<0.006	<0.006	<0.006	-	<0.006	<0.006	<0.006	<0.006	<0.006	<0.006	<0.006	-	<0.006	<0.006	<0.006	<0.006	<0.006	<0.006	<0.006	-	<0.006	<0.006	<0.006	<0.006
Arsenic (As)	mg/L	0.0015	0.05	0.0084	0.017	0.0015	0.0015	0.0015	0.035	0.0015	0.05	0.0084	0.017	0.0015	0.0015	0.0015	0.035	<0.003	<0.003	<0.003	-	<0.003	<0.003	<0.003	<0.003
Barium (Ba)	mg/L	0.01	0.022	0.014	0.004	0.011	0.012	0.016	0.021	0.026	0.077	0.043	0.016	0.033	0.037	0.048	0.069	0.023	0.041	0.031	0.0075	0.026	0.029	0.035	0.04
Beryllium (Be)	mg/L	<0.001	<0.001	<0.001	-	<0.001	<0.001	<0.001	<0.001	<0.001	<0.001	<0.001	-	<0.001	<0.001	<0.001	<0.001	<0.001	<0.001	<0.001	-	<0.001	<0.001	<0.001	<0.001
Boron (B)	mg/L	0.016	0.022	0.019	0.0021	0.018	0.019	0.021	0.022	0.011	0.027	0.02	0.0052	0.018	0.022	0.023	0.026	0.005	0.012	0.0073	0.0033	0.005	0.005	0.0085	0.011
Cadmium (Cd)	mg/L	0.00001	0.0001	0.000051	0.000024	0.00005	0.00005	0.00005	0.000085	0.00001	0.0001	0.000051	0.000024	0.00005	0.00005	0.00005	0.000085	<0.0001	<0.0001	<0.0001	-	<0.0001	<0.0001	<0.0001	<0.0001
Chromium (Cr)	mg/L	<0.003	<0.003	<0.003	-	<0.003	<0.003	<0.003	<0.003	<0.003	<0.003	<0.003	-	<0.003	<0.003	<0.003	<0.003	<0.003	<0.003	<0.003	-	<0.003	<0.003	<0.003	<0.003
Cobalt (Co)	mg/L	0.00025	0.0005	0.00029	0.000087	0.00025	0.00025	0.00025	0.00043	0.00025	0.0005	0.00029	0.000087	0.00025	0.00025	0.00025	0.00043	<0.0005	<0.0005	<0.0005	-	<0.0005	<0.0005	<0.0005	<0.0005
Copper (Cu)	mg/L	0.0006	0.001	0.00094	0.00014	0.001	0.001	0.001	0.001	0.0007	0.004	0.0018	0.0012	0.001	0.001	0.0025	0.0037	<0.002	<0.002	<0.002	-	<0.002	<0.002	<0.002	<0.002
Iron (Fe)	mg/L	0.005	0.057	0.012	0.018	0.005	0.005	0.005	0.041	0.005	0.039	0.013	0.012	0.005	0.005	0.017	0.032	0.005	0.052	0.021	0.022	0.005	0.005	0.029	0.047
Lead (Pb)	mg/L	0.00005	0.0005	0.00044	0.00016	0.0005	0.0005	0.0005	0.0005	0.00005	0.0005	0.00044	0.00016	0.0005	0.0005	0.0005	0.0005	<0.001	<0.001	<0.001	-	<0.001	<0.001	<0.001	<0.001
Manganese (Mn)	mg/L	0.004	0.059	0.022	0.02	0.0075	0.013	0.032	0.055	0.082	0.11	0.097	0.01	0.09	0.098	0.1	0.11	0.096	0.18	0.13	0.039	0.099	0.1	0.14	0.17
Mercury (Hg)	mg/L	0.0000013	0.00005	0.000043	0.000017	0.00005	0.00005	0.00005	0.00005	0.0000013	0.00005	0.000043	0.000017	0.00005	0.00005	0.00005	0.00005	<0.0001	<0.0001	<0.0001	-	<0.0001	<0.0001	<0.0001	<0.0001
Molybdenum (Mo)	mg/L	0.004	0.008	0.0057	0.0013	0.005	0.005	0.0065	0.0077	0.005	0.013	0.0077	0.0029	0.0055	0.007	0.009	0.012	<0.002	<0.002	<0.002	-	<0.002	<0.002	<0.002	<0.002
Nickel (Ni)	mg/L	<0.003	<0.003	<0.003	-	<0.003	<0.003	<0.003	<0.003	0.0015	0.013	0.0045	0.0039	0.0015	0.003	0.0055	0.011	0.0015	0.003	0.002	0.00071	0.0015	0.0015	0.0023	0.0029
Selenium (Se)	mg/L	0.002	0.05	0.0089	0.017	0.002	0.002	0.002	0.036	0.002	0.05	0.0089	0.017	0.002	0.002	0.002	0.036	<0.004	<0.004	<0.004	-	<0.004	<0.004	<0.004	<0.004
Silver (Ag)	mg/L	0.00002	0.00005	0.000046	0.00001	0.00005	0.00005	0.00005	0.00005	0.000005	0.00005	0.000044	0.000016	0.00005	0.00005	0.00005	0.00005	<0.0001	<0.0001	<0.0001	-	<0.0001	<0.0001	<0.0001	<0.0001
Strontium (Sr)	mg/L	0.057	0.067	0.062	0.0037	0.059	0.061	0.066	0.067	0.051	0.089	0.07	0.012	0.064	0.074	0.076	0.086	0.14	0.15	0.15	0.0039	0.15	0.15	0.15	0.15
Thallium (Tl)	mg/L	0.000005	0.00015	0.00013	0.000051	0.00015	0.00015	0.00015	0.00015	0.000005	0.00015	0.00013	0.000051	0.00015	0.00015	0.00015	0.00015	<0.0003	<0.0003	<0.0003	-	<0.0003	<0.0003	<0.0003	<0.0003
Titanium (Ti)	mg/L	<0.002	<0.002	<0.002	-	<0.002	<0.002	<0.002	<0.002	<0.002	<0.002	<0.002	-	<0.002	<0.002	<0.002	<0.002	<0.002	<0.002	<0.002	-	<0.002	<0.002	<0.002	<0.002
Tungsten (W)	mg/L	0.005	0.034	0.015	0.011	0.005	0.012	0.021	0.032	0.02	0.68	0.21	0.29	0.028	0.031	0.34	0.67	0.005	0.02	0.01	0.0071	0.005	0.005	0.013	0.019
Uranium (U)	mg/L	0.003	0.004	0.0039	0.00035	0.004	0.004	0.004	0.004	0.001	0.004	0.0016	0.001	0.001	0.001	0.0015	0.0034	0.001	0.004	0.002	0.0014	0.001	0.001	0.0025	0.0037
Vanadium (V)	mg/L	<0.002	<0.002	<0.002	-	<0.002	<0.002	<0.002	<0.002	<0.002	<0.002	<0.002	-	<0.002	<0.002	<0.002	<0.002	<0.002	<0.002	<0.002	-	<0.002	<0.002	<0.002	<0.002
Zinc (Zn)	mg/L	0.0025	0.032	0.0081	0.01	0.0025	0.0025	0.0073	0.026	0.0025	0.26	0.077	0.092	0.038	0.017	0.13	0.23	0.0025	0.019	0.0098	0.0069	0.0053	0.008	0.014	0.018
Zirconium (Zr)	mg/L	<0.004	<0.004	<0.004	-	<0.004	<0.004	<0.004	<0.004	<0.004	<0.004	<0.004	-	<0.004	<0.004	<0.004	<0.004	<0.004	<0.004	<0.004	-	<0.004	<0.004	<0.004	<0.004
OTHER PARAMETERS																									
Total Cyanide	mg/L	<0.002	<0.002	<0.002	-	<0.002	<0.002	<0.002	<0.002	0.001	0.005	0.0016	0.0014	0.001	0.001	0.001	0.0038	<0.002	<0.002	<0.002	-	<0.002	<0.002	<0.002	<0.002
Total Ammonia (NH ₃ + NH ₄)	mg/L as N	0.01	0.12	0.034	0.037	0.01	0.01	0.04	0.096	0.01	0.08	0.046	0.024	0.025	0.05	0.065	0.077	0.01	0.05	0.0					

TABLE 3a
STATISTICAL SUMMARY OF UPDATED BASELINE GROUNDWATER QUALITY DATASET
CÔTÉ GOLD PROJECT

Parameter	Unit	DH12-WD-23 (n=7)								DH12-WD-01 (n=3)							DH12-WD-25A (n=7)								
		Minimum	Maximum	Average	Standard Deviation	25th percentile	Median	75 th percentile	95 th percentile	Minimum	Maximum	Average	Standard Deviation	25th percentile	Median	75 th percentile	95 th percentile	Minimum	Maximum	Average	Standard Deviation	25th percentile	Median	75 th percentile	95 th percentile
GENERAL PARAMETERS																									
pH	pH units	7.60	8.10	7.90	0.18	7.80	8.00	8.10	8.10	6.90	7.40	7.30	0.22	7.20	7.40	7.40	7.40	6.70	7.90	7.30	0.41	7.10	7.50	7.60	7.80
Alkalinity	mg/L as CaCO ₃	170	180	180	6.4	170	180	180	180	30	74	56	19	48	65	70	73	63	81	71	5.3	70	70	73	80
Electrical Conductivity (EC)	µS/cm	310	350	330	20	310	330	350	350	87	160	130	32	120	150	150	160	140	180	160	12	150	160	170	180
Total Dissolved Solids (TDS)	mg/L	200	250	220	17	210	220	240	250	52	100	87	25	78	100	100	100	98	120	110	8	100	100	120	120
Total Suspended Solids (TSS)	mg/L as CaCO ₃	1900	15000	5500	4300	2300	4200	6500	13000	38	1400	520	590	99	160	760	1200	150	1600	590	450	310	430	680	1300
Total Hardness	mg/L as CaCO ₃	170	190	180	5.1	180	180	190	190	37	71	57	15	50	64	68	70	71	82	76	3.9	74	75	79	82
MAJOR IONS																									
Calcium (Ca)	mg/L	56	61	58	1.8	57	58	60	60	12	23	19	4.8	17	22	23	23	22	25	24	1.1	23	23	24	25
Magnesium (Mg)	mg/L	7.9	9	8.4	0.35	8.1	8.4	8.6	8.8	1.3	3.2	2.3	0.77	1.8	2.2	2.7	3.1	3.8	4.7	4.2	0.31	4	4.1	4.4	4.7
Potassium (K)	mg/L	0.05	2.2	1.6	0.69	1.6	1.9	2.1	2.2	0.45	0.87	0.7	0.18	0.62	0.78	0.83	0.86	0.05	0.94	0.57	0.27	0.5	0.56	0.73	0.92
Sodium (Na)	mg/L	0.00005	2.4	1.8	0.76	1.9	2.1	2.2	2.3	2.2	4.9	3.6	1.1	2.9	3.6	4.3	4.8	0.00005	1.7	1.4	0.56	1.5	1.6	1.6	1.7
Chloride (Cl)	mg/L	0.52	0.81	0.66	0.08	0.63	0.67	0.67	0.77	0.6	0.82	0.71	0.09	0.66	0.71	0.77	0.81	0.55	0.8	0.64	0.089	0.59	0.6	0.7	0.79
Fluoride (F)	mg/L	<0.05	<0.05	<0.05	-	<0.05	<0.05	<0.05	<0.05	0.025	0.15	0.067	0.059	0.025	0.025	0.088	0.14	<0.05	<0.05	<0.05	-	<0.05	<0.05	<0.05	<0.05
Sulphate (SO ₄)	mg/L	0.05	0.13	0.093	0.029	0.075	0.1	0.11	0.13	9.3	11	10	0.71	9.8	10	11	11	6.7	8.5	8	0.55	7.9	8	8.3	8.5
METALS																									
Aluminum (Al)	mg/L	0.007	0.023	0.015	0.0059	0.009	0.017	0.02	0.022	0.037	0.12	0.069	0.038	0.042	0.047	0.085	0.11	0.02	0.04	0.028	0.0063	0.024	0.024	0.031	0.037
Antimony (Sb)	mg/L	<0.006	<0.006	<0.006	-	<0.006	<0.006	<0.006	<0.006	<0.006	<0.006	<0.006	-	<0.006	<0.006	<0.006	<0.006	<0.006	<0.006	<0.006	-	<0.006	<0.006	<0.006	<0.006
Arsenic (As)	mg/L	0.0015	0.05	0.0084	0.017	0.0015	0.0015	0.0015	0.035	<0.003	<0.003	<0.003	-	<0.003	<0.003	<0.003	<0.003	0.008	0.014	0.011	0.0017	0.01	0.01	0.011	0.013
Barium (Ba)	mg/L	0.026	0.033	0.029	0.0022	0.027	0.028	0.03	0.032	0.006	0.023	0.012	0.0078	0.0065	0.007	0.015	0.021	0.005	0.008	0.0069	0.00083	0.007	0.007	0.007	0.0077
Beryllium (Be)	mg/L	<0.001	<0.001	<0.001	-	<0.001	<0.001	<0.001	<0.001	<0.001	<0.001	<0.001	-	<0.001	<0.001	<0.001	<0.001	<0.001	<0.001	<0.001	-	<0.001	<0.001	<0.001	<0.001
Boron (B)	mg/L	0.005	0.012	0.006	0.0024	0.005	0.005	0.005	0.0099	<0.01	<0.01	<0.01	-	<0.01	<0.01	<0.01	<0.01	<0.01	<0.01	<0.01	-	<0.01	<0.01	<0.01	<0.01
Cadmium (Cd)	mg/L	0.00001	0.00005	0.000044	0.000014	0.00005	0.00005	0.00005	0.00005	0.00005	0.0002	0.0001	0.000071	0.00005	0.00005	0.00013	0.00019	0.00001	0.00005	0.000044	0.000014	0.00005	0.00005	0.00005	0.00005
Chromium (Cr)	mg/L	<0.003	<0.003	<0.003	-	<0.003	<0.003	<0.003	<0.003	<0.003	<0.003	<0.003	-	<0.003	<0.003	<0.003	<0.003	<0.003	<0.003	<0.003	-	<0.003	<0.003	<0.003	<0.003
Cobalt (Co)	mg/L	<0.0005	<0.0005	<0.0005	-	<0.0005	<0.0005	<0.0005	<0.0005	0.0008	0.0015	0.001	0.00033	0.0008	0.0008	0.0012	0.0014	<0.0005	<0.0005	<0.0005	-	<0.0005	<0.0005	<0.0005	<0.0005
Copper (Cu)	mg/L	0.0001	0.001	0.00087	0.00031	0.001	0.001	0.001	0.001	0.003	0.009	0.0063	0.0025	0.005	0.007	0.008	0.0088	0.0006	0.001	0.00094	0.00014	0.001	0.001	0.001	0.001
Iron (Fe)	mg/L	1.4	2	1.8	0.21	1.6	1.9	1.9	2	0.024	0.84	0.3	0.38	0.035	0.045	0.44	0.76	3.7	4.4	4.2	0.25	4.1	4.3	4.4	4.4
Lead (Pb)	mg/L	0.0001	0.0005	0.00044	0.00014	0.0005	0.0005	0.0005	0.0005	<0.001	<0.001	<0.001	-	<0.001	<0.001	<0.001	<0.001	0.00005	0.0005	0.00044	0.00016	0.0005	0.0005	0.0005	0.0005
Manganese (Mn)	mg/L	0.16	0.19	0.17	0.012	0.17	0.17	0.18	0.19	0.054	0.3	0.17	0.1	0.11	0.16	0.23	0.29	0.27	0.31	0.29	0.016	0.28	0.29	0.3	0.31
Mercury (Hg)	mg/L	0.0000013	0.00005	0.000043	0.000017	0.00005	0.00005	0.00005	0.00005	<0.0001	<0.0001	<0.0001	-	<0.0001	<0.0001	<0.0001	<0.0001	0.0000013	0.00005	0.000043	0.000017	0.00005	0.00005	0.00005	
Molybdenum (Mo)	mg/L	0.001	0.008	0.0026	0.0024	0.001	0.001	0.003	0.0068	0.001	0.033	0.012	0.015	0.001	0.001	0.017	0.03	<0.002	<0.002	<0.002	-	<0.002	<0.002	<0.002	<0.002
Nickel (Ni)	mg/L	<0.003	<0.003	<0.003	-	<0.003	<0.003	<0.003	<0.003	0.0015	0.005	0.0027	0.0016	0.0015	0.0015	0.0033	0.0047	<0.003	<0.003	<0.003	-	<0.003	<0.003	<0.003	<0.003
Selenium (Se)	mg/L	0.002	0.05	0.0089	0.017	0.002	0.002	0.002	0.036	<0.004	<0.004	<0.004	-	<0.004	<0.004	<0.004	<0.004	0.0001	0.002	0.0017	0.00066	0.002	0.002	0.002	0.002
Silver (Ag)	mg/L	0.00005	0.00006	0.000051	0.000035	0.00005	0.00005	0.00005	0.000057	<0.0001	<0.0001	<0.0001	-	<0.0001	<0.0001	<0.0001	<0.0001	0.00003	0.00005	0.000047	0.000007	0.00005	0.00005	0.00005	
Strontium (Sr)	mg/L	0.056	0.064	0.058	0.0026	0.057	0.058	0.059	0.063	0.025	0.08	0.051	0.023	0.037	0.048	0.064	0.077	0.044	0.054	0.048	0.0033	0.046	0.048	0.05	0.053
Thallium (Tl)	mg/L	0.00002	0.00015	0.00013	0.000045	0.00015	0.00015	0.00015	0.00015	<0.0003	<0.0003	<0.0003	-	<0.0003	<0.0003	<0.0003	<0.0003	0.000005	0.00015	0.00013	0.000051	0.00015	0.00015	0.00015	0.00015
Titanium (Ti)	mg/L	0.001	0.002	0.0016	0.00049	0.001	0.002	0.002	0.002	<0.002	<0.002	<0.002	-	<0.002	<0.002	<0.002	<0.002	<0.002	<0.002	<0.002	-	<0.002	<0.002	<0.002	<0.002
Tungsten (W)	mg/L	0.005	0.021	0.0073	0.0056	0.005	0.005	0.005	0.016	0.005	0.11	0.046	0.044	0.015	0.025	0.066	0.099	<0.01	<0.01	<0.01	-	<0.01	<0.01	<0.01	<0.01
Uranium (U)	mg/L	<0.002	<0.002	<0.002	-	<0.002	<0.002	<0.002	<0.002	<0.002	<0.002	<0.002	-	<0.002	<0.002	<0.002	<0.002	<0.002	<0.002	<0.002	-	<0.002	<0.002	<0.002	<0.002
Vanadium (V)	mg/L	0.001	0.003	0.0021	0.00064	0.002	0.002	0.0025	0.003	0.001	0.002	0.0013	0.00047	0.001	0.001	0.0015	0.0019	<0.002	<0.002	<0.002	-	<0.002	<0.002	<0.002	<0.002
Zinc (Zn)	mg/L	0.0025	0.037	0.0074	0.012	0.0025	0.0025	0.0025	0.027	0.0025	0.86	0.29	0.4	0.058	0.009	0.44	0.78	0.0025	0.011	0.0053	0.0035	0.0025	0.0025	0.008	0.011
Zirconium (Zr)	mg/L	<0.004	<0.004	<0.004	-	<0.004	<0.004	<0.004	<0.004	<0.004	<0.004	<0.004	-	<0.004	<0.004	<0.004	<0.004	<0.004	<0.004	<0.004	-	<0.004	<0.004	<0.004	<0.004
OTHER PARAMETERS																									
Total Cyanide	mg/L	<0.002	<0.002	<0.002	-	<0.002	<0.002	<0.002	<0.002	<0.002	<0.002	<0.002	-	<0.002	<0.002	<0.002	<0.002	0.001	0.003	0.0013	0.0007	0.001	0.001	0.001	0.0024
Total Ammonia (NH ₃ + NH ₄)	mg/L as N	0.07	0.28	0.17	0.069	0.13	0.18	0.21	0.26	<0.02	<0.02	<0.02	-	<0.02	<0.02	<0.02	<0.02								

TABLE 3a
STATISTICAL SUMMARY OF UPDATED BASELINE GROUNDWATER QUALITY DATASET
CÔTÉ GOLD PROJECT

Parameter	Unit	DH12-WD-25B (n=7)								DH12-WD-26 (n=7)								DH12-WD-27A (n=3)							
		Minimum	Maximum	Average	Standard Deviation	25th percentile	Median	75 th percentile	95 th percentile	Minimum	Maximum	Average	Standard Deviation	25th percentile	Median	75 th percentile	95 th percentile	Minimum	Maximum	Average	Standard Deviation	25th percentile	Median	75 th percentile	95 th percentile
GENERAL PARAMETERS																									
pH	pH units	7.20	8.00	7.60	0.28	7.50	7.70	7.80	7.90	6.90	8.00	7.70	0.36	7.70	7.80	7.90	8.00	6.50	8.20	7.70	0.63	7.90	7.90	8.10	8.20
Alkalinity	mg/L as CaCO ₃	98	140	120	14	110	120	130	130	120	170	140	14	130	140	150	160	28	150	110	42	120	120	150	
Electrical Conductivity (EC)	µS/cm	210	270	240	22	220	250	250	270	270	370	300	34	280	300	320	360	68	290	220	80	250	250	260	290
Total Dissolved Solids (TDS)	mg/L	10	180	140	55	140	160	170	180	150	270	210	33	200	210	220	250	52	170	140	44	150	160	170	170
Total Suspended Solids (TSS)	mg/L as CaCO ₃	2900	20000	7900	5500	4200	5800	9400	17000	23	600	150	190	40	48	130	470	310	2700	1400	1000	380	1200	2400	2600
Total Hardness	mg/L as CaCO ₃	100	140	120	11	110	120	130	130	94	120	110	10	97	110	120	120	29	150	110	42	120	120	140	140
MAJOR IONS																									
Calcium (Ca)	mg/L	33	45	40	3.6	38	41	42	44	31	40	35	3.5	32	34	38	40	6.8	42	31	13	34	34	39	42
Magnesium (Mg)	mg/L	4.2	5.7	4.8	0.46	4.5	4.7	5	5.5	3.6	6.7	4.8	0.93	4.3	4.4	5.1	6.2	2.9	9.9	7.8	2.6	8	8.8	9.5	9.8
Potassium (K)	mg/L	0.05	0.77	0.58	0.22	0.62	0.64	0.67	0.75	0.82	1.2	1	0.12	0.93	0.95	1.1	1.2	0.58	1.2	1	0.23	0.91	1.1	1.1	1.2
Sodium (Na)	mg/L	3	6.6	4.8	1	4.5	4.6	5.3	6.3	11	46	26	11	19	24	30	41	1.7	4.7	3.6	1.1	2.9	4.3	4.5	4.6
Chloride (Cl)	mg/L	0.67	2.1	0.99	0.46	0.73	0.81	0.97	1.8	0.72	3.4	1.9	1	1.1	1.3	2.8	3.2	0.41	0.8	0.64	0.13	0.6	0.68	0.71	0.78
Fluoride (F)	mg/L	0.025	0.05	0.029	0.0087	0.025	0.025	0.025	0.043	0.25	0.51	0.38	0.094	0.3	0.4	0.46	0.5	0.025	0.11	0.066	0.036	0.025	0.07	0.1	0.11
Sulphate (SO ₄)	mg/L	0.77	5.9	3.2	2.2	1.2	4.5	4.9	5.7	3.4	59	16	19	4.2	5.1	17	49	4.8	13	11	3.1	12	12	13	13
METALS																									
Aluminum (Al)	mg/L	0.008	0.21	0.046	0.068	0.013	0.015	0.032	0.16	0.006	0.015	0.0099	0.0026	0.009	0.009	0.011	0.014	0.002	0.021	0.011	0.0065	0.007	0.011	0.015	0.02
Antimony (Sb)	mg/L	<0.006	<0.006	<0.006	-	<0.006	<0.006	<0.006	<0.006	<0.006	<0.006	<0.006	-	<0.006	<0.006	<0.006	<0.006	<0.006	<0.006	<0.006	-	<0.006	<0.006	<0.006	<0.006
Arsenic (As)	mg/L	0.004	0.006	0.0051	0.00083	0.0045	0.005	0.006	0.006	0.004	0.009	0.005	0.0017	0.004	0.004	0.005	0.0078	0.0015	0.05	0.011	0.019	0.0015	0.0015	0.0015	0.04
Barium (Ba)	mg/L	0.013	0.026	0.02	0.0039	0.018	0.019	0.022	0.025	0.008	0.017	0.012	0.003	0.01	0.012	0.015	0.016	0.003	0.021	0.014	0.0059	0.015	0.015	0.016	0.02
Beryllium (Be)	mg/L	<0.001	<0.001	<0.001	-	<0.001	<0.001	<0.001	<0.001	<0.001	<0.001	<0.001	-	<0.001	<0.001	<0.001	<0.001	<0.001	<0.001	<0.001	-	<0.001	<0.001	<0.001	<0.001
Boron (B)	mg/L	<0.01	<0.01	<0.01	-	<0.01	<0.01	<0.01	<0.01	0.012	0.017	0.014	0.0019	0.012	0.013	0.015	0.017	0.005	0.01	0.006	0.002	0.005	0.005	0.005	0.009
Cadmium (Cd)	mg/L	0.00001	0.00005	0.000044	0.000014	0.00005	0.00005	0.00005	0.00005	0.00001	0.00005	0.000044	0.000014	0.00005	0.00005	0.00005	0.00005	0.00001	0.0001	0.000052	0.000029	0.00005	0.00005	0.00005	0.00009
Chromium (Cr)	mg/L	<0.003	<0.003	<0.003	-	<0.003	<0.003	<0.003	<0.003	<0.003	<0.003	<0.003	-	<0.003	<0.003	<0.003	<0.003	<0.003	<0.003	<0.003	-	<0.003	<0.003	<0.003	<0.003
Cobalt (Co)	mg/L	<0.0005	<0.0005	<0.0005	-	<0.0005	<0.0005	<0.0005	<0.0005	0.00025	0.0007	0.00031	0.00016	0.00025	0.00025	0.00025	0.00057	<0.0005	<0.0005	<0.0005	-	<0.0005	<0.0005	<0.0005	<0.0005
Copper (Cu)	mg/L	0.0001	0.001	0.00087	0.00031	0.001	0.001	0.001	0.001	0.0006	0.003	0.0012	0.00074	0.001	0.001	0.001	0.0024	0.0004	0.001	0.00088	0.00024	0.001	0.001	0.001	0.001
Iron (Fe)	mg/L	3	4.5	3.6	0.51	3.3	3.5	3.9	4.5	0.73	1.4	1.2	0.21	1.1	1.2	1.3	1.4	0.005	0.089	0.022	0.034	0.005	0.005	0.005	0.072
Lead (Pb)	mg/L	0.00005	0.0005	0.00044	0.00016	0.0005	0.0005	0.0005	0.0005	0.00005	0.0005	0.00044	0.00016	0.0005	0.0005	0.0005	0.0005	0.00005	0.0005	0.00041	0.00018	0.0005	0.0005	0.0005	0.0005
Manganese (Mn)	mg/L	0.36	0.44	0.39	0.028	0.37	0.39	0.41	0.44	0.22	0.28	0.25	0.019	0.23	0.25	0.26	0.27	0.013	0.057	0.045	0.017	0.047	0.053	0.057	0.057
Mercury (Hg)	mg/L	0.000013	0.00005	0.000043	0.000017	0.00005	0.00005	0.00005	0.00005	0.000013	0.00005	0.000043	0.000017	0.00005	0.00005	0.00005	0.00005	0.000013	0.00005	0.00004	0.00002	0.00005	0.00005	0.00005	0.00005
Molybdenum (Mo)	mg/L	<0.002	<0.002	<0.002	-	<0.002	<0.002	<0.002	<0.002	0.005	0.012	0.0073	0.0022	0.006	0.006	0.008	0.011	<0.002	<0.002	<0.002	-	<0.002	<0.002	<0.002	<0.002
Nickel (Ni)	mg/L	<0.003	<0.003	<0.003	-	<0.003	<0.003	<0.003	<0.003	<0.003	<0.003	<0.003	-	<0.003	<0.003	<0.003	<0.003	<0.003	<0.003	<0.003	-	<0.003	<0.003	<0.003	<0.003
Selenium (Se)	mg/L	0.002	0.05	0.0089	0.017	0.002	0.002	0.002	0.036	0.002	0.05	0.0089	0.017	0.002	0.002	0.002	0.036	0.002	0.05	0.012	0.019	0.002	0.002	0.002	0.04
Silver (Ag)	mg/L	0.00002	0.00005	0.000046	0.00001	0.00005	0.00005	0.00005	0.00005	0.00001	0.00005	0.000044	0.000014	0.00005	0.00005	0.00005	0.00005	0.000005	0.0001	0.000051	0.00003	0.00005	0.00005	0.00005	0.00009
Strontium (Sr)	mg/L	0.053	0.078	0.065	0.0083	0.06	0.064	0.072	0.077	0.052	0.083	0.064	0.01	0.057	0.063	0.07	0.08	0.014	0.14	0.075	0.043	0.052	0.076	0.087	0.13
Thallium (Tl)	mg/L	0.000005	0.00015	0.00013	0.000051	0.00015	0.00015	0.00015	0.00015	0.000005	0.00015	0.00013	0.000051	0.00015	0.00015	0.00015	0.00015	0.000005	0.00015	0.00012	0.000058	0.00015	0.00015	0.00015	0.00015
Titanium (Ti)	mg/L	0.001	0.011	0.0024	0.0035	0.001	0.001	0.001	0.008	0.001	0.002	0.0011	0.00035	0.001	0.001	0.001	0.0017	<0.002	<0.002	<0.002	-	<0.002	<0.002	<0.002	<0.002
Tungsten (W)	mg/L	<0.01	<0.01	<0.01	-	<0.01	<0.01	<0.01	<0.01	0.005	0.029	0.011	0.0082	0.005	0.005	0.013	0.025	<0.01	<0.01	<0.01	-	<0.01	<0.01	<0.01	<0.01
Uranium (U)	mg/L	<0.002	<0.002	<0.002	-	<0.002	<0.002	<0.002	<0.002	<0.002	<0.002	<0.002	-	<0.002	<0.002	<0.002	<0.002	<0.002	<0.002	<0.002	-	<0.002	<0.002	<0.002	<0.002
Vanadium (V)	mg/L	<0.002	<0.002	<0.002	-	<0.002	<0.002	<0.002	<0.002	0.001	0.003	0.002	0.00093	0.001	0.002	0.003	0.003	<0.002	<0.002	<0.002	-	<0.002	<0.002	<0.002	<0.002
Zinc (Zn)	mg/L	0.0025	0.024	0.0075	0.0082	0.0025	0.0025	0.0093	0.022	0.0025	0.23	0.037	0.078	0.0025	0.0025	0.0095	0.16	0.0025	0.028	0.0083	0.0099	0.0025	0.0025	0.006	0.024
Zirconium (Zr)	mg/L	<0.004	<0.004	<0.004	-	<0.004	<0.004	<0.004	<0.004	<0.004	<0.004	<0.004	-	<0.004	<0.004	<0.004	<0.004	<0.004	<0.004	<0.004	-	<0.004	<0.004	<0.004	<0.004
OTHER PARAMETERS																									
Total Cyanide	mg/L	0.001	0.012	0.0026	0.0038	0.001	0.001	0.001	0.0087	<0.002	<0.002	<0.002	-	<0.002	<0.002	<0.002	<0.002	<0.002	<0.002	<0.002	-	<0.002	<0.002	<0.002	<0.002
Total Ammonia (NH ₃ + NH ₄)	mg/L as N	0.17	0.4	0.29	0.085	0.22	0.28	0.37	0.39	0.02	0.18	0.11	0.047	0.095	0.13	0.14	0.17	0.01	0.22						

TABLE 3a
STATISTICAL SUMMARY OF UPDATED BASELINE GROUNDWATER QUALITY DATASET
CÔTÉ GOLD PROJECT

Parameter	Unit	DH12-WD-27B (n=5)							
		Minimum	Maximum	Average	Standard Deviation	25th percentile	Median	75 th percentile	95 th percentile
GENERAL PARAMETERS									
pH	pH units	6.09	8.13	7.46	0.8	7.22	7.85	8.01	8.11
Alkalinity	mg/L as CaCO ₃	21	136	88.2	53	25	125	134	136
Electrical Conductivity (EC)	µS/cm	59	272	186	100	69	259	271	272
Total Dissolved Solids (TDS)	mg/L	2180	6100	3936	1476	2490	3960	4950	5870
Total Suspended Solids (TSS)	mg/L as CaCO ₃	58	608	221	198	110	152	176	522
Total Hardness	mg/L as CaCO ₃	23	157	91	56	26.2	114	136	153
MAJOR IONS									
Calcium (Ca)	mg/L	4.8	45	26	17	5.7	33	39	44
Magnesium (Mg)	mg/L	0.61	0.9	0.78	0.10	0.71	0.8	0.86	0.89
Potassium (K)	mg/L	1.4	8.1	3.4	2.4	2.0	2.6	3.1	7.1
Sodium (Na)	mg/L	0.025	0.17	0.05	0.06	0.025	0.025	0.025	0.14
Chloride (Cl)	mg/L	2.6	11	6.6	3.3	2.9	7.6	9.1	10
Fluoride (F)	mg/L	0.38	1.2	0.88	0.29	0.77	0.96	1.1	1.2
Sulphate (SO ₄)	mg/L	4.3	14	9.7	4.1	5.2	12	13	14
METALS									
Aluminum (Al)	mg/L	0.008	0.15	0.066	0.054	0.028	0.04	0.10	0.14
Antimony (Sb)	mg/L	<0.006	<0.006	<0.006	-	<0.006	<0.006	<0.006	<0.006
Arsenic (As)	mg/L	0.0015	0.05	0.011	0.019	0.0015	0.0015	0.0015	0.040
Barium (Ba)	mg/L	0.001	0.017	0.0098	0.0072	0.001	0.014	0.016	0.017
Beryllium (Be)	mg/L	<0.001	<0.001	<0.001	-	<0.001	<0.001	<0.001	<0.001
Boron (B)	mg/L	<0.01	<0.01	<0.01	-	<0.01	<0.01	<0.01	<0.01
Cadmium (Cd)	mg/L	0.00001	0.00005	0.000042	0.000016	0.00005	0.00005	0.00005	0.00005
Chromium (Cr)	mg/L	<0.003	<0.003	<0.003	-	<0.003	<0.003	<0.003	<0.003
Cobalt (Co)	mg/L	<0.0005	<0.0005	<0.0005	-	<0.0005	<0.0005	<0.0005	<0.0005
Copper (Cu)	mg/L	0.0004	0.005	0.0017	0.0017	0.001	0.001	0.001	0.0042
Iron (Fe)	mg/L	0.005	0.15	0.05	0.056	0.005	0.028	0.061	0.14
Lead (Pb)	mg/L	0.0001	0.0005	0.00042	0.00016	0.0005	0.0005	0.0005	0.0005
Manganese (Mn)	mg/L	0.001	0.063	0.0234	0.024	0.001	0.016	0.036	0.058
Mercury (Hg)	mg/L	0.00000125	0.00005	0.000040	0.000020	0.00005	0.00005	0.00005	0.00005
Molybdenum (Mo)	mg/L	<0.002	<0.002	<0.002	-	<0.002	<0.002	<0.002	<0.002
Nickel (Ni)	mg/L	0.0015	0.004	0.002	0.001	0.0015	0.0015	0.0015	0.0035
Selenium (Se)	mg/L	0.002	0.05	0.0116	0.0192	0.002	0.002	0.002	0.0404
Silver (Ag)	mg/L	0.00005	0.0001	0.00006	0.00002	0.00005	0.00005	0.00005	0.00009
Strontium (Sr)	mg/L	0.014	0.075	0.044	0.025	0.015	0.054	0.06	0.072
Thallium (Tl)	mg/L	0.000005	0.00015	0.00012	0.000058	0.00015	0.00015	0.00015	0.00015
Titanium (Ti)	mg/L	0.001	0.005	0.0018	0.0016	0.001	0.001	0.001	0.0042
Tungsten (W)	mg/L	<0.01	<0.01	<0.01	-	<0.01	<0.01	<0.01	<0.01
Uranium (U)	mg/L	0.001	0.003	0.0016	0.0008	0.001	0.001	0.002	0.0028
Vanadium (V)	mg/L	<0.002	<0.002	<0.002	-	<0.002	<0.002	<0.002	<0.002
Zinc (Zn)	mg/L	0.0025	0.166	0.0389	0.063952639	0.0025	0.0025	0.021	0.137
Zirconium (Zr)	mg/L	<0.004	<0.004	<0.004	-	<0.004	<0.004	<0.004	<0.004
OTHER PARAMETERS									
Total Cyanide	mg/L	<0.002	<0.002	<0.002	-	<0.002	<0.002	<0.002	<0.002
Total Ammonia (NH ₃ + NH ₄)	mg/L as N	0.01	0.12	0.042	0.04	0.02	0.02	0.04	0.10

Notes:

Values with the less than sign ("<") indicate concentrations below the laboratory method detection limit.
 For the purposes of statistical calculations, values less than the laboratory detection limit were assumed to be equal to one-half the detection limit.
 Dashes ("-") indicate the statistic was not calculated.

TABLE 4a
QUALITY ASSURANCE/QUALITY CONTROL BLIND DUPLICATES WITH RELATIVE PERCENT DIFFERENCE >20%
CÔTÉ GOLD PROJECT

Sample Location	Sampling Date	Parameter (units)	Sample Concentration	Duplicate Concentration	Detection Limit
SL	31-May-12	TDS (mg/L)	56	80	20
		Total Cyanide (mg/L)	0.004	0.002	0.002
		Total Ammonia (mg/L)	0.19	0.02	0.02
		Barium (mg/L)	0.005	0.004	0.002
		Iron (mg/L)	0.014	0.01	0.01
		Zinc (mg/L)	0.061	0.005	0.005
	18-Jul-12	Iron (mg/L)	0.034	0.05	0.01
		Manganese (mg/L)	0.033	0.045	0.002
		Zinc (mg/L)	<0.005	0.065	0.005
		Total Phosphorus (mg/L)	<0.02	0.03	0.02
	20-Aug-12	Alkalinity (mg/L)	27	13	5
		Electrical Conductivity (µS/cm)	0.06	0.043	0.002
		TSS (mg/L)	10	0.01	1, 10
		Total Hardness (mg/L)	28.9	20.2	0.5
	24-Sep-12	Total Phosphorus (mg/L)	0.03	0.02	0.02
		TSS (mg/L)	<1	2	1
		Zinc (mg/L)	0.007	<0.005	0.005
	23-Oct-12	TSS (mg/L)	3	4	1
	17-Dec-12	Aluminum (mg/L)	0.012	0.015	0.004
	29-Jan-13	Alkalinity (mg/L)	28	21	5
		Chloride (mg/L)	0.38	0.74	0.1
		TDS (mg/L)	44	20	20
		TSS (mg/L)	13.2	1	1, 10
		DOC (mg/L)	8.5	14.2	0.5
		Calcium (mg/L)	9.46	7.18	0.05
		Sodium (mg/L)	0.73	1.17	0.05
		Chloride (mg/L)	0.38	0.74	0.1
		Sulphate (mg/L)	3.19	3.95	0.1
		Aluminum (mg/L)	0.028	0.096	0.004
		Barium (mg/L)	0.007	0.005	0.002
		Copper (mg/L)	0.002	0.004	0.002
		Iron (mg/L)	0.041	0.176	0.01
Manganese (mg/L)		0.023	0.01	0.002	
Strontium (mg/L)		0.025	0.02	0.005	
24-Feb-13	Alkalinity (mg/L)	28	16	5	
	Electrical Conductivity (µS/cm)	0.073	0.052	0.002	
	TSS (mg/L)	3	1	1, 10	
	Total Hardness (mg/L)	32.2	24.2	0.5	
	Dissolved Organic Carbon (mg/L)	8.2	13.5	0.5	
	Chloride (mg/L)	0.34	0.91	0.1	
	Total Ammonia (mg/L)	0.52	0.3	0.02	
	Potassium (mg/L)	0.36	0.47	0.05	
	Calcium (mg/L)	10.4	7.46	0.05	
	Sodium (mg/L)	0.78	1.11	0.05	
	Aluminum (mg/L)	0.03	0.058	0.004	
	Barium (mg/L)	0.008	0.006	0.002	
	Manganese (mg/L)	0.039	0.01	0.002	
	Strontium (mg/L)	0.024	0.013	0.005	
BPD	31-May-12	Sodium (mg/L)	0.91	0.71	0.05
		Barium (mg/L)	0.004	0.005	0.002
		Zinc (mg/L)	0.006	0.044	0.005

TABLE 4a
QUALITY ASSURANCE/QUALITY CONTROL BLIND DUPLICATES WITH RELATIVE PERCENT DIFFERENCE >20%
CÔTÉ GOLD PROJECT

Sample Location	Sampling Date	Parameter (units)	Sample Concentration	Duplicate Concentration	Detection Limit
3D-c	28-Jun-12	Total Cyanide (mg/L)	<0.002	0.012	0.002
		Dissolved Aluminum (mg/L)	0.043	0.03	0.004
		Barium (mg/L)	0.004	0.006	0.002
		Iron (mg/L)	0.104	0.137	0.01
		Manganese (mg/L)	0.022	0.036	0.002
		Strontium (mg/L)	0.012	0.025	0.005
		Zinc (mg/L)	0.024	0.32	0.005
	18-Jul-12	Total Cyanide (mg/L)	0.002	0.016	0.002
		Total Dissolved Solids (mg/L)	48	38	20
		Barium (mg/L)	0.004	0.003	0.002
	20-Aug-12	Zinc (mg/L)	0.02	0.007	0.005
		Fluoride (mg/L)	0.05	0.00005	0.05, 50
	20-Aug-12	Total Phosphorus (mg/L)	<0.02	0.04	0.02
		TSS (mg/L)	<1	2	1
	24-Sep-12	Aluminum (mg/L)	0.013	0.018	0.004
		Cadmium (mg/L)	0.0001	0.0003	0.0001
		TDS (mg/L)	50	40	20
	30-Oct-12	Chloride (mg/L)	0.58	0.00059	0.1
		Zinc (mg/L)	0.007	<0.005	0.005
	29-Jan-13	TDS (mg/L)	20	88	20
		Total Ammonia (mg/L)	0.04	0.05	0.02
Zinc (mg/L)		0.017	0.011	0.005	
24-Feb-13	Total Ammonia (mg/L)	0.04	0.03	0.02	
	DOC (mg/L)	12.8	10	0.5	
	Chloride (mg/L)	0.88	0.38	0.1	
	Iron (mg/L)	0.107	0.159	0.01	
	Magnesium (mg/L)	1.36	1.87	0.05	
24-Feb-13	Zinc (mg/L)	0.043	0.009	0.005	
	19-Mar-13	Manganese (mg/L)	0.009	0.007	0.002
CHLK	25-Jun-12	Zinc (mg/L)	<0.005	0.016	0.005
DH12-PO-14B	28-May-12	TSS (mg/L)	16000	12300	10
		Potassium (mg/L)	0.59	0.86	0.05
		Sodium (mg/L)	8.55	4.98	0.05
		Aluminum (mg/L)	0.094	0.025	0.004
		Zinc (mg/L)	0.153	0.028	0.004
		Ammonia (mg/L)	0.27	0.11	0.02
DH12-TMF-16	6-Jun-12	Aluminum (mg/L)	0.184	0.025	0.004
		Barium (mg/L)	0.006	0.003	0.002
		Iron (mg/L)	0.02	<0.01	0.01
		Manganese (mg/L)	0.017	0.004	0.002
		Silver (mg/L)	0.0002	<0.0001	0.0001
		Strontium (mg/L)	0.034	0.021	0.005
DH12-TMF-27A	29-Nov-12	Zinc (mg/L)	0.353	<0.005	0.005
		TSS (mg/L)	598	772	10
		Sulphate (mg/L)	6.84	5.53	0.1
		Copper (mg/L)	0.004	0.003	0.002
		Silver (mg/L)	0.0001	0.0002	0.0001
BH12-4	29-Nov-12	Titanium (mg/L)	0.002	0.003	0.0001, 0.002
		TSS (mg/L)	189	283	10
		TDS (mg/L)	182	90	20
		Aluminum (mg/L)	0.031	0.017	0.004
DH12-WD-25B	29-Nov-12	Zinc (mg/L)	0.043	0.01	0.005
		TSS (mg/L)	7550	5770	10
		Aluminum (mg/L)	0.082	0.02	0.004
		Arsenic (mg/L)	0.005	0.004	0.003
		Zinc (mg/L)	0.137	<0.005	0.005

TABLE 5a
SUMMARY OF SURFACE WATER QUALITY MONITORING PROGRAM
CÔTÉ GOLD PROJECT

Station	Station Description	Northing (NAD83 Zone 17N)	Easting (NAD83 Zone 17N)	Monitoring Events	Total Number of Monitoring Events	Approximate Monitoring Frequency	Water Quality Station	Water Column Profile Lake Station
<i>Mesomikenda Lake Watershed</i>								
P-6	Outlet of wetland to creek upstream of Bagsverd Lake	5268056	427783	March 2012 April 2012 May 2012 June 2012 July 2012 August 2012 September 2012 October 2012 November 2012 December 2012 January 2013 February 2013 March 2013 April 2013 May 2013 June 2013 July 2013 August 2013 September 2013 October 2013 November 2013 December 2013 April 2014 May 2014	24	monthly	✓	
LCM	Outlet of Little Clam Lake to small watercourse	5267779	428484	February 2012 April 2012 May 2012 June 2012 July 2012 August 2012 September 2012 October 2012 November 2012 January 2013 February 2013 March 2013 May 2013 June 2013 July 2013 August 2013 September 2013 October 2013 November 2013 December 2013 January 2014 May 2014	22	monthly	✓	
P-3	Watercourse that drains into Bagsverd Lake	5268328	430462	November 2012 February 2013 May 2013 August 2013 November 2013 May 2014	6	quarterly	✓	
SL	Bridge crossing upstream of Bagsverd Lake, downstream of Schist Lake	5269771	428496	January 2012 February 2012 March 2012 April 2012 May 2012 June 2012 July 2012 August 2012 September 2012 October 2012 November 2012 December 2012 January 2013 February 2013 March 2013 April 2013 May 2013 June 2013 July 2013 August 2013 September 2013 October 2013 November 2013 December 2013 January 2014 April 2014	26	monthly	✓	
BAG-LS1	Bagsverd Lake (upper)	5270214	429886	May 2013 August 2013 October 2013 February 2014 June 2014	5	quarterly	✓	✓
BAG-LS2	Bagsverd Lake (lower)	5269674	430218	May 2013 August 2013 October 2013 February 2014 June 2014	5	quarterly		✓

**TABLE 5a
SUMMARY OF SURFACE WATER QUALITY MONITORING PROGRAM
CÔTÉ GOLD PROJECT**

Station	Station Description	Northing (NAD83 Zone 17N)	Easting (NAD83 Zone 17N)	Monitoring Events	Total Number of Monitoring Events	Approximate Monitoring Frequency	Water Quality Station	Water Column Profile Lake Station
BPD	Channel-wide rock outcrop on Bagsverd Creek upstream of BL-a subwatershed, downstream of Bagsverd Lake	5270639	431343	March 2012 April 2012 May 2012 June 2012 July 2012 August 2012 September 2012 October 2012 November 2012 December 2012 January 2013 February 2013 March 2013 May 2013 June 2013 July 2013 August 2013 September 2013 October 2013 November 2013 December 2013 January 2014 May 2014	23	monthly	✓	
L-2	Culvert road crossing of creek upstream of BL-b subwatershed	5273456	428297	March 2012 April 2012 May 2012 June 2012 July 2012 August 2012 September 2012 October 2012 November 2012 December 2012 January 2013 February 2013 March 2013 April 2013 May 2013 June 2013 July 2013 August 2013 September 2013 October 2013 November 2013 December 2013 January 2014 April 2014	24	monthly	✓	
BL-a	Culvert road crossing of Bagsverd Creek upstream of BL-b subwatershed	5273627	430136	January 2012 February 2012 March 2012 April 2012 May 2012 June 2012 July 2012 August 2012 September 2012 October 2012 November 2012 December 2012 January 2013 February 2013 March 2013 April 2013 May 2013 June 2013 July 2013 August 2013 September 2013 October 2013 November 2013 December 2013 January 2014 April 2014	26	monthly	✓	
BL-b	Culvert road crossing of Bagsverd Creek upstream of Neville Lake	5277424	430561	January 2012 February 2012 March 2012 April 2012 May 2012 June 2012 July 2012 August 2012 September 2012 October 2012 November 2012 December 2012 January 2013 February 2013 March 2013 April 2013 May 2013 June 2013 July 2013 August 2013 September 2013 October 2013 November 2013 December 2013 January 2014 April 2014 May 2014	27	monthly	✓	

TABLE 5a
SUMMARY OF SURFACE WATER QUALITY MONITORING PROGRAM
CÔTÉ GOLD PROJECT

Station	Station Description	Northing (NAD83 Zone 17N)	Easting (NAD83 Zone 17N)	Monitoring Events	Total Number of Monitoring Events	Approximate Monitoring Frequency	Water Quality Station	Water Column Profile Lake Station
WL-1	Wolf Lake	5278209	426646	May 2012 August 2012 November 2012 February 2013 May 2013 June 2013 July 2013 August 2013 September 2013 October 2013 November 2013 January 2014	12	quarterly	✓	
SR	Culvert road crossing of Somme River upstream of Neville Lake	5280153	429894	January 2012 February 2012 March 2012 May 2012 August 2012 November 2012 December 2012 January 2013 February 2013 March 2013 April 2013 May 2013 June 2013 July 2013 August 2013 September 2013 October 2013 November 2013 December 2013 April 2014	20	monthly	✓	
NL	Neville Lake outflow	5278422	431497	January 2013 February 2013 March 2013 May 2013 June 2013 July 2013 August 2013 September 2013 October 2013 December 2013 January 2014 May 2014	12	monthly	✓	
NEV-LS	Neville Lake	5277466	431443	May 2013 August 2013 October 2013 November 2013 February 2014 June 2014	6	quarterly	✓	✓
MESO-OUT	Mesomikenda Lake dam (upper basin)	5283774	435026	January 2013 February 2013 March 2013 May 2013 June 2013 July 2013 August 2013 September 2013 October 2013 November 2013 December 2013 January 2014 May 2014	13	monthly	✓	
MESO-LS1	Mesomikenda Lake (upper basin)	5284838	433043	May 2013 August 2013 November 2013 February 2014 June 2014	5	quarterly		✓
MESO-LS2	Mesomikenda Lake (upper basin)	5281444	433501	May 2013 August 2013 November 2013 February 2014 June 2014	5	quarterly	✓	✓
MESO-LS3	Mesomikenda Lake (upper basin)	5277486	433694	May 2013 August 2013 November 2013 February 2014 June 2014	5	quarterly		✓
MESO-LS4	Mesomikenda Lake (upper/middle basin)	5274044	433428	May 2013 August 2013 November 2013 February 2014 June 2014	5	quarterly	✓	✓

TABLE 5a
SUMMARY OF SURFACE WATER QUALITY MONITORING PROGRAM
CÔTÉ GOLD PROJECT

Station	Station Description	Northing (NAD83 Zone 17N)	Easting (NAD83 Zone 17N)	Monitoring Events	Total Number of Monitoring Events	Approximate Monitoring Frequency	Water Quality Station	Water Column Profile Lake Station
MESO-LS5	Mesomikenda Lake (middle basin)	5272218	433282	May 2013 August 2013 November 2013 February 2014 June 2014	5	quarterly	✓	✓
MESO-LS6	Mesomikenda Lake (middle basin)	5269712	433695	May 2013 August 2013 November 2013 February 2014 June 2014	5	quarterly		✓
MESO-LS7	Mesomikenda Lake (lower basin)	5267851	434288	May 2013 August 2013 November 2013 February 2014 June 2014	5	quarterly		✓
<i>Mollie River Watershed</i>								
CHLK	Culvert road crossing at Chester Lake outlet	5265373	429883	January 2012 February 2012 March 2012 April 2012 May 2012 June 2012 July 2012 August 2012 September 2012 October 2012 November 2012 December 2012 January 2013 February 2013 March 2013 April 2013 May 2013 June 2013 July 2013 August 2013 September 2013 October 2013 November 2013 December 2013 January 2014 April 2014 May 2014	27	monthly	✓	
CHLK-LS	Chester Lake	5263895	429580	May 2013 August 2013 October 2013 February 2014	4	quarterly	✓	✓
P-2	Watercourse from small beaver impoundment that merges with drainage from Chester Lake	5265587	430358	November 2012 February 2013 May 2013 August 2013 November 2013 May 2014	6	quarterly	✓	
P-1	Intermittent watercourse that drains into Clam Lake	5265572	429420	February 2013	1	quarterly	✓	
P-5	Ponded area between Clam Lake and Côté Lake	5265822	429599	May 2012 November 2012 May 2013 August 2013 November 2013 April 2014	6	quarterly	✓	
CM	Culvert road crossing of Clam Lake	5267121	428624	January 2012 February 2012 March 2012 April 2012 May 2012 June 2012 July 2012 August 2012 September 2012 October 2012 November 2012 December 2012 January 2013 February 2013 March 2013 April 2013 May 2013 June 2013 July 2013 August 2013 September 2013 October 2013 November 2013 December 2013 January 2014 April 2014	26	monthly	✓	

TABLE 5a
SUMMARY OF SURFACE WATER QUALITY MONITORING PROGRAM
CÔTÉ GOLD PROJECT

Station	Station Description	Northing (NAD83 Zone 17N)	Easting (NAD83 Zone 17N)	Monitoring Events	Total Number of Monitoring Events	Approximate Monitoring Frequency	Water Quality Station	Water Column Profile Lake Station
CM-LS1	Clam Lake (upper basin)	5267008	428195	May 2013 August 2013 October 2013 February 2014 June 2014	5	quarterly		✓
CM-LS2	Clam Lake (lower basin)	5266218	428286	May 2013 August 2013 October 2013 February 2014 June 2014	5	quarterly	✓	✓
CL	Culvert road crossing of Mollie River, upstream of Three Duck Lakes, downstream of Côté Lake	5267486	430164	September 2011 October 2011 November 2011 December 2011 January 2012 February 2012 March 2012 April 2012 May 2012 June 2012 July 2012 August 2012 September 2012 October 2012 November 2012 December 2012 January 2013 February 2013 March 2013 April 2013 May 2013 June 2013 July 2013 August 2013 September 2013 October 2013 November 2013 December 2013 January 2014 April 2014	30	monthly	✓	
WD	Culvert road crossing at Weeduck Lake outlet, upstream of Three Duck Lakes	5268135	431442	September 2011 October 2011 November 2011 December 2011 January 2012 February 2012 March 2012 April 2012 May 2012 June 2012 July 2012 August 2012 September 2012 October 2012 November 2012 December 2012 January 2013 February 2013 March 2013 April 2013 May 2013 June 2013 July 2013 August 2013 September 2013 October 2013 November 2013 December 2013 January 2014 April 2014	30	monthly	✓	
MP	Culvert road crossing upstream of northern basin of Three Duck Lakes, downstream of ore processing plant pond	5267531	431992	September 2011 October 2011 November 2011 December 2011 January 2012 February 2012 March 2012 April 2012 May 2012 June 2012 July 2012 August 2012 September 2012 October 2012 November 2012 December 2012 January 2013 April 2013 May 2013 June 2013 July 2013 August 2013 September 2013 October 2013 November 2013 January 2014 April 2014	27	monthly	✓	

TABLE 5a
SUMMARY OF SURFACE WATER QUALITY MONITORING PROGRAM
CÔTÉ GOLD PROJECT

Station	Station Description	Northing (NAD83 Zone 17N)	Easting (NAD83 Zone 17N)	Monitoring Events	Total Number of Monitoring Events	Approximate Monitoring Frequency	Water Quality Station	Water Column Profile Lake Station
P-7	Watercourse that drains into central basin of Three Duck Lakes	5266019	432777	May 2012 August 2012 November 2012 February 2013 May 2013 August 2013 November 2013 April 2014	8	quarterly	✓	
3D-LS1	Three Duck Lakes (upper basin)	5267888	431472	May 2013 August 2013 October 2013 February 2014 June 2014	5	quarterly	✓	✓
3D-LS2	Three Duck Lakes (middle basin)	5265870	431875	May 2013 August 2013 October 2013 February 2014 June 2014	5	quarterly	✓	✓
3D-c	Narrows in south basin of Three Duck Lakes, near outlet	5263621	432866	February 2012 March 2012 April 2012 May 2012 June 2012 July 2012 August 2012 September 2012 October 2012 November 2012 January 2013 February 2013 March 2013 May 2013 June 2013 July 2013 August 2013 September 2013 October 2013 December 2013 January 2014 May 2014	22	monthly	✓	
P-4	Watercourse that drains into Moille River, downstream of Three Duck Lakes outlet	5263631	432098	May 2012 November 2012 February 2013 April 2014	4	quarterly	✓	
DEL-LS	Delaney Lake	5262415	431333	May 2013 August 2013 February 2014	3	quarterly	✓	✓
DIV-LS	Dividing Lake	5261248	435197	May 2013 August 2013 November 2013 June 2014	4	quarterly	✓	✓

TABLE 6a
WATER QUALITY COMPARISON OF LAKES AND WATERCOURSES AFFECTED BY REALIGNMENT - CÔTÉ LAKE AND THREE DUCK LAKES (UPPER)
CÔTÉ GOLD PROJECT

Parameter	Unit	CL - Côté Lake Outlet (n=30)								3D-LS1 - Three Duck Lakes (Upper) (Lake Station) (n=10)							
		Minimum	Maximum	Average	Standard Deviation	25 th percentile	Median	75 th percentile	95 th percentile	Minimum	Maximum	Average	Standard Deviation	25 th percentile	Median	75 th percentile	95 th percentile
FIELD PARAMETERS																	
pH	pH units	5.20	7.52	6.83	0.48	6.71	6.92	7.07	7.40	6.00	8.20	7.00	0.60	6.70	6.80	7.40	8.05
Temperature	degrees Celsius	-1.3	24	8.5	8.8	0.30	4.1	18	22	0.66	20	12	6.1	10.0	11	16	20
Conductivity	µS/cm	20	49	32	8.1	25	29	37	44	32	99	53	24	33	46	55	99
Dissolved Oxygen (DO)	mg/L	4.9	18	9.9	2.8	8.3	9.8	11	15	3.0	11.0	8.4	2.7	7.8	9.3	11.0	11
GENERAL PARAMETERS																	
Lab pH	pH units	5.79	7.45	6.65	0.36	6.44	6.67	6.89	7.10	6.16	6.84	6.46	0.24	6.28	6.40	6.62	6.84
Alkalinity	mg/L as CaCO ₃	8.0	30	14	3.8	12	13	15	19	8.0	14	11	2.3	8.3	11	13	14
Electrical Conductivity (EC)	µS/cm	33	57	45	5.4	43	46	49	54	33	48	41	5.5	34	43	45	47
Total Dissolved Solids (TDS)	mg/L	28	524	69	85	44	54	60	81	24	60	45	13	32	50	56	58
Total Suspended Solids (TSS)	mg/L	0.50	5.0	3.1	1.7	2.0	3.0	5.0	5.0	0.50	5.0	4.3	1.5	5.0	5.0	5.0	5.0
Total Hardness	mg/L as CaCO ₃	17	27	22	2.6	20	22	23	26	15	25	19	2.8	18	19	20	24
Dissolved Organic Carbon (DOC)	mg/L	11	27	13	2.8	12	13	14	16	9.6	16	13	1.9	12	13	14	15
MAJOR IONS																	
Calcium (Ca)	mg/L	5.2	8.2	6.8	0.80	6.3	6.9	7.3	8.2	4.6	7.7	5.9	0.88	5.6	5.8	6.2	7.4
Magnesium (Mg)	mg/L	0.89	1.5	1.2	0.15	1.1	1.2	1.3	1.4	0.82	1.4	1.0	0.14	0.97	1.00	1.1	1.3
Potassium (K)	mg/L	0.22	0.45	0.33	0.060	0.29	0.33	0.39	0.42	0.26	0.42	0.33	0.053	0.31	0.32	0.37	0.42
Sodium (Na)	mg/L	0.76	1.3	0.95	0.12	0.85	0.94	1.0	1.1	0.65	0.99	0.82	0.10	0.78	0.80	0.91	0.96
Chloride (Cl)	mg/L	0.27	1.3	0.63	0.21	0.53	0.62	0.69	1.01	0.28	0.65	0.44	0.11	0.38	0.41	0.52	0.62
Fluoride (F)	mg/L	<0.05	<0.05	<0.05	-	<0.05	<0.05	<0.05	<0.05	<0.05	<0.05	<0.05	-	<0.05	<0.05	<0.05	<0.05
Sulphate (SO ₄)	mg/L	1.8	3.7	2.9	0.52	2.5	2.9	3.2	3.7	2.2	3.3	2.9	0.34	2.8	2.9	3.0	3.3
METALS																	
Aluminum (Al)	mg/L	0.015	0.095	0.057	0.021	0.042	0.055	0.073	0.088	0.031	0.11	0.070	0.031	0.034	0.085	0.098	0.103
Antimony (Sb)	mg/L	<0.006	<0.006	<0.006	-	<0.006	<0.006	<0.006	<0.006	0.0015	0.0030	0.0018	0.00060	0.0015	0.0015	0.0015	0.0030
Arsenic (As)	mg/L	<0.003	<0.003	<0.003	-	<0.003	<0.003	<0.003	<0.003	<0.003	<0.003	<0.003	-	<0.003	<0.003	<0.003	<0.003
Barium (Ba)	mg/L	0.0030	0.0070	0.0051	0.00096	0.0040	0.0050	0.0060	0.0066	0.0040	0.0070	0.0046	0.00092	0.0040	0.0040	0.0050	0.0061
Beryllium (Be)	mg/L	<0.001	<0.001	<0.001	-	<0.001	<0.001	<0.001	<0.001	<0.001	<0.001	<0.001	-	<0.001	<0.001	<0.001	<0.001
Boron (B)	mg/L	<0.01	<0.01	<0.01	-	<0.01	<0.01	<0.01	<0.01	<0.01	<0.01	<0.01	-	<0.01	<0.01	<0.01	<0.01
Cadmium (Cd)	mg/L	0.000010	0.00030	0.000049	0.000050	0.000050	0.000050	0.000050	0.000050	0.000010	0.000050	0.000019	0.000016	0.000010	0.000010	0.000018	0.000050
Chromium (Cr)	mg/L	<0.003	<0.003	<0.003	-	<0.003	<0.003	<0.003	<0.003	<0.003	<0.003	<0.003	-	<0.003	<0.003	<0.003	<0.003
Cobalt (Co)	mg/L	<0.0005	<0.0005	<0.0005	-	<0.0005	<0.0005	<0.0005	<0.0005	<0.0005	<0.0005	<0.0005	-	<0.0005	<0.0005	<0.0005	<0.0005
Copper (Cu)	mg/L	0.00060	0.0030	0.0011	0.00052	0.0010	0.0010	0.0010	0.0024	0.0010	0.0031	0.0016	0.00063	0.0012	0.0014	0.0016	0.0028
Iron (Fe)	mg/L	0.095	0.41	0.22	0.085	0.15	0.21	0.28	0.36	0.10	0.32	0.17	0.071	0.11	0.15	0.20	0.30
Lead (Pb)	mg/L	0.000050	0.0030	0.00050	0.00049	0.00050	0.00050	0.00050	0.00050	0.00010	0.00050	0.00025	0.00014	0.00020	0.00020	0.00028	0.00050
Manganese (Mn)	mg/L	0.012	0.11	0.039	0.022	0.024	0.034	0.047	0.071	0.011	0.093	0.034	0.026	0.019	0.023	0.029	0.086
Mercury (Hg)	mg/L	0.0000095	0.000050	0.000040	0.000020	0.000050	0.000050	0.000050	0.000050	0.0000095	0.000050	0.000012	0.000019	0.0000095	0.0000095	0.0000067	0.0000500
Molybdenum (Mo)	mg/L	<0.002	<0.002	<0.002	-	<0.002	<0.002	<0.002	<0.002	0.000050	0.0010	0.00081	0.00038	0.0010	0.0010	0.0010	0.0010
Nickel (Ni)	mg/L	<0.003	<0.003	<0.003	-	<0.003	<0.003	<0.003	<0.003	0.0015	0.017	0.0032	0.0046	0.0015	0.0015	0.0015	0.0107
Selenium (Se)	mg/L	0.000050	0.0020	0.0016	0.00080	0.0020	0.0020	0.0020	0.0020	0.000050	0.0020	0.00044	0.00078	0.000050	0.000050	0.000050	0.002000
Silver (Ag)	mg/L	0.0000050	0.00020	0.000045	0.000034	0.000050	0.000050	0.000050	0.000050	0.0000050	0.000050	0.000018	0.000019	0.0000050	0.0000050	0.000031	0.000050
Strontium (Sr)	mg/L	0.011	0.021	0.015	0.0020	0.013	0.015	0.015	0.018	0.0090	0.017	0.012	0.0023	0.010	0.013	0.013	0.016
Thallium (Tl)	mg/L	0.0000050	0.00015	0.00012	0.000060	0.00015	0.00015	0.00015	0.00015	0.0000050	0.00015	0.000034	0.000058	0.0000050	0.0000050	0.0000050	0.0001500
Titanium (Ti)	mg/L	0.0010	0.0030	0.0012	0.00054	0.0010	0.0010	0.0010	0.0026	<0.002	<0.002	<0.002	-	<0.002	<0.002	<0.002	<0.002
Tungsten (W)	mg/L	<0.01	<0.01	<0.01	-	<0.01	<0.01	<0.01	<0.01	<0.01	<0.01	<0.01	-	<0.01	<0.01	<0.01	<0.01
Uranium (U)	mg/L	<0.002	<0.002	<0.002	-	<0.002	<0.002	<0.002	<0.002	<0.002	<0.002	<0.002	-	<0.002	<0.002	<0.002	<0.002
Vanadium (V)	mg/L	<0.002	<0.002	<0.002	-	<0.002	<0.002	<0.002	<0.002	<0.002	<0.002	<0.002	-	<0.002	<0.002	<0.002	<0.002
Zinc (Zn)	mg/L	0.0025	0.049	0.0064	0.0092	0.0025	0.0025	0.0060	0.0182	0.0025	0.010	0.0036	0.0024	0.0025	0.0025	0.0025	0.0082
Zirconium (Zr)	mg/L	<0.004	<0.004	<0.004	-	<0.004	<0.004	<0.004	<0.004	<0.004	<0.004	<0.004	-	<0.004	<0.004	<0.004	0.0020
OTHER PARAMETERS																	
Total Cyanide	mg/L	<0.002	<0.002	<0.002	-	<0.002	<0.002	<0.002	<0.002	<0.002	<0.002	<0.002	-	<0.002	<0.002	<0.002	<0.002
Total Ammonia (NH ₃ + NH ₄)	mg/L as N	0.010	0.060	0.026	0.019	0.010	0.020	0.038	0.060	0.010	0.080	0.022	0.022	0.010	0.010	0.025	0.062
Un-ionized Ammonia (NH ₃)	mg/L	0.0000004	0.00022	0.000045	0.000055	0.000013	0.000023	0.000046	0.000163	0.0000080	0.00028	0.000084	0.000084	0.0000143	0.000058	0.00013	0.00023
Total Phosphorus (P)	mg/L	0.010	0.060	0.017	0.012	0.010	0.010	0.026	0.030	0.010	0.030	0.014	0.0061	0.010	0.011	0.015	0.025

Notes:

Values with the less than sign ("<") indicate concentrations below the laboratory method detection limit.
 For the purposes of statistical calculations, values less than the laboratory detection limit were assumed to be equal to one-half the detection limit.
 Dashes ("-") indicate the statistic was not calculated.

⁽¹⁾ For sample locations where n=1, statistics were not calculated.

TABLE 6a
WATER QUALITY COMPARISON OF LAKES AND WATERCOURSES AFFECTED BY REALIGNMENT - CHESTER LAKE AND CLAM LAKE
CÔTÉ GOLD PROJECT

Parameter	Unit	CHLK - Chester Lake (n=27)								CM - Culvert Road Crossing of Clam Lake (n=26)							
		Minimum	Maximum	Average	Standard Deviation	25 th percentile	Median	75 th percentile	95 th percentile	Minimum	Maximum	Average	Standard Deviation	25 th percentile	Median	75 th percentile	95 th percentile
FIELD PARAMETERS																	
pH	pH units	4.50	7.68	6.68	0.66	6.54	6.78	7.11	7.50	5.54	8.48	6.97	0.65	6.66	6.99	7.35	7.90
Temperature	degrees Celsius	-0.080	26	8.9	8.8	1.6	4.0	18	24	-1.0	27	8.4	8.9	1.3	3.1	18	25
Conductivity	µS/cm	19	48	29	8.2	23	27	33	45	20	58	30	9.5	25	34	48	
Dissolved Oxygen (DO)	mg/L	5.5	15	9.8	2.5	8.1	9.4	12	14	1.2	19	9.1	4.5	6.2	8.8	13	16
GENERAL PARAMETERS																	
Lab pH	pH units	6.02	6.98	6.53	0.26	6.36	6.60	6.74	6.90	6.02	7.13	6.63	0.26	6.44	6.61	6.80	7.00
Alkalinity	mg/L as CaCO ₃	6.0	17	12	2.4	11	12	14	15	9.0	17	13	1.6	13	14	14	16
Electrical Conductivity (EC)	µS/cm	27	51	41	5.9	38	41	43	50	36	52	44	3.7	41	43	46	50
Total Dissolved Solids (TDS)	mg/L	10	70	45	15	41	46	55	62	10	86	37	15	28	37	47	50
Total Suspended Solids (TSS)	mg/L	0.50	6.0	2.6	2.0	0.75	2.0	5.0	5.0	0.50	5.8	3.7	1.8	2.0	5.0	5.0	5.0
Total Hardness	mg/L as CaCO ₃	13	25	20	2.9	18	20	22	24	15	24	19	2.0	18	19	20	22
Dissolved Organic Carbon (DOC)	mg/L	8.3	17	13	1.9	12	13	13	16	5.7	11	8.1	1.1	7.2	7.9	8.7	10.0
MAJOR IONS																	
Calcium (Ca)	mg/L	4.1	7.7	6.2	0.93	5.4	6.2	6.8	7.6	4.9	7.9	6.2	0.66	5.8	6.3	6.5	7.3
Magnesium (Mg)	mg/L	0.73	1.4	1.1	0.16	0.99	1.1	1.2	1.3	0.67	1.1	0.92	0.093	0.86	0.92	0.98	1.04
Potassium (K)	mg/L	0.18	0.36	0.29	0.049	0.26	0.30	0.33	0.36	0.27	0.33	0.40	0.12	0.35	0.38	0.42	0.47
Sodium (Na)	mg/L	0.68	1.0	0.81	0.080	0.77	0.81	0.87	0.93	0.55	0.82	0.69	0.052	0.67	0.69	0.72	0.75
Chloride (Cl)	mg/L	0.15	0.54	0.32	0.087	0.24	0.33	0.38	0.41	0.24	0.48	0.34	0.053	0.29	0.34	0.36	0.44
Fluoride (F)	mg/L	<0.05	<0.05	<0.05	-	<0.05	<0.05	<0.05	<0.05	<0.05	<0.05	<0.05	-	<0.05	<0.05	<0.05	<0.05
Sulphate (SO ₄)	mg/L	1.6	3.8	2.9	0.45	2.7	2.8	3.1	3.6	2.5	4.9	3.6	0.61	3.2	3.7	4.0	4.8
METALS																	
Aluminum (Al)	mg/L	0.024	0.10	0.062	0.019	0.047	0.060	0.071	0.092	0.0040	0.078	0.020	0.017	0.0073	0.018	0.026	0.050
Antimony (Sb)	mg/L	<0.006	<0.006	<0.006	-	<0.006	<0.006	<0.006	<0.006	<0.006	<0.006	<0.006	-	<0.006	<0.006	<0.006	<0.006
Arsenic (As)	mg/L	<0.003	<0.003	<0.003	-	<0.003	<0.003	<0.003	<0.003	<0.003	<0.003	<0.003	-	<0.003	<0.003	<0.003	<0.003
Barium (Ba)	mg/L	0.0030	0.0080	0.0046	0.00091	0.0040	0.0050	0.0050	0.0057	0.0030	0.0060	0.0042	0.00088	0.0040	0.0040	0.0048	0.0060
Beryllium (Be)	mg/L	<0.001	<0.001	<0.001	-	<0.001	<0.001	<0.001	<0.001	<0.001	<0.001	<0.001	-	<0.001	<0.001	<0.001	<0.001
Boron (B)	mg/L	<0.01	<0.01	<0.01	-	<0.01	<0.01	<0.01	<0.01	<0.01	<0.01	<0.01	-	<0.01	<0.01	<0.01	<0.01
Cadmium (Cd)	mg/L	0.000010	0.000050	0.000038	0.000018	0.000010	0.000050	0.000050	0.000050	0.000010	0.000050	0.000039	0.000018	0.000020	0.000050	0.000050	0.000050
Chromium (Cr)	mg/L	<0.003	<0.003	<0.003	-	<0.003	<0.003	<0.003	<0.003	<0.003	<0.003	<0.003	-	<0.003	<0.003	<0.003	<0.003
Cobalt (Co)	mg/L	<0.0005	<0.0005	<0.0005	-	<0.0005	<0.0005	<0.0005	<0.0005	<0.0005	<0.0005	<0.0005	-	<0.0005	<0.0005	<0.0005	<0.0005
Copper (Cu)	mg/L	0.00060	0.0010	0.00092	0.00013	0.00085	0.0010	0.0010	0.0010	0.0010	0.0027	0.0012	0.00038	0.0010	0.0010	0.0011	0.0019
Iron (Fe)	mg/L	0.086	0.35	0.19	0.074	0.14	0.18	0.24	0.32	0.0050	0.29	0.077	0.067	0.035	0.051	0.092	0.222
Lead (Pb)	mg/L	0.00010	0.00050	0.00039	0.00017	0.00020	0.00050	0.00050	0.00050	0.000050	0.00050	0.00038	0.00019	0.00020	0.00050	0.00050	0.00050
Manganese (Mn)	mg/L	0.010	0.065	0.027	0.013	0.018	0.023	0.034	0.053	0.0030	0.058	0.017	0.013	0.0083	0.013	0.018	0.039
Mercury (Hg)	mg/L	0.0000095	0.000050	0.000036	0.000021	0.000027	0.000050	0.000050	0.000050	0.0000095	0.000050	0.000037	0.000022	0.000040	0.000050	0.000050	0.000050
Molybdenum (Mo)	mg/L	<0.002	<0.002	<0.002	-	<0.002	<0.002	<0.002	<0.002	<0.002	<0.002	<0.002	-	<0.002	<0.002	<0.002	<0.002
Nickel (Ni)	mg/L	<0.003	<0.003	<0.003	-	<0.003	<0.003	<0.003	<0.003	<0.003	<0.003	<0.003	-	<0.003	<0.003	<0.003	<0.003
Selenium (Se)	mg/L	0.000050	0.0020	0.0014	0.00087	0.00025	0.0020	0.0020	0.0020	0.000050	0.0020	0.0015	0.00085	0.00065	0.0020	0.0020	0.0020
Silver (Ag)	mg/L	0.0000050	0.000050	0.000037	0.000020	0.000008	0.000050	0.000050	0.000050	0.0000050	0.00010	0.000040	0.000023	0.000016	0.000050	0.000050	0.000050
Strontium (Sr)	mg/L	0.0080	0.025	0.013	0.0031	0.011	0.013	0.015	0.017	0.010	0.017	0.013	0.0017	0.012	0.013	0.014	0.017
Thallium (Tl)	mg/L	0.0000050	0.00015	0.00011	0.000065	0.00001	0.00015	0.00015	0.00015	0.0000050	0.00015	0.00011	0.000064	0.000041	0.00015	0.00015	0.00015
Titanium (Ti)	mg/L	<0.002	<0.002	<0.002	-	<0.002	<0.002	<0.002	<0.002	0.0010	0.0030	0.0011	0.00042	0.0010	0.0010	0.0010	0.0018
Tungsten (W)	mg/L	<0.01	<0.01	<0.01	-	<0.01	<0.01	<0.01	<0.01	<0.01	<0.01	<0.01	-	<0.01	<0.01	<0.01	<0.01
Uranium (U)	mg/L	<0.002	<0.002	<0.002	-	<0.002	<0.002	<0.002	<0.002	<0.002	<0.002	<0.002	-	<0.002	<0.002	<0.002	<0.002
Vanadium (V)	mg/L	<0.002	<0.002	<0.002	-	<0.002	<0.002	<0.002	<0.002	<0.002	<0.002	<0.002	-	<0.002	<0.002	<0.002	<0.002
Zinc (Zn)	mg/L	0.0025	0.055	0.011	0.014	0.0025	0.0025	0.010	0.040	0.0025	0.0090	0.0034	0.0021	0.0025	0.0025	0.0025	0.0088
Zirconium (Zr)	mg/L	<0.004	<0.004	<0.004	-	<0.004	<0.004	<0.004	<0.004	<0.004	<0.004	<0.004	-	<0.004	<0.004	<0.004	<0.004
OTHER PARAMETERS																	
Total Cyanide	mg/L	<0.002	<0.002	<0.002	-	<0.002	<0.002	<0.002	<0.002	<0.002	<0.002	<0.002	-	<0.002	<0.002	<0.002	<0.002
Total Ammonia (NH ₃ + NH ₄)	mg/L as N	0.010	0.070	0.024	0.017	0.010	0.020	0.035	0.057	0.010	0.13	0.034	0.029	0.010	0.030	0.040	0.080
Un-ionized Ammonia (NH ₃)	mg/L	0.0000014	0.00018	0.000038	0.000048	0.0000090	0.000014	0.000047	0.000135	0.0000010	0.0012	0.00011	0.00023	0.000010	0.000039	0.00011	0.00030
Total Phosphorus (P)	mg/L	0.010	0.050	0.019	0.012	0.010	0.010	0.030	0.040	0.0090	0.040	0.017	0.011	0.010	0.010	0.028	0.040

Notes:

Values with the less than sign ("<") indicate concentrations below the laboratory method detection limit.
 For the purposes of statistical calculations, values less than the laboratory detection limit were assumed to be equal to one-half the detection limit.
 Dashes ("-") indicate the statistic was not calculated.

⁽¹⁾ For sample locations where n=1, statistics were not calculated.

TABLE 6a
WATER QUALITY COMPARISON OF LAKES AND WATERCOURSES AFFECTED BY REALIGNMENT - LITTLE CLAM LAKE AND WEST BEAVER POND
CÔTÉ GOLD PROJECT

Parameter	Unit	LCM - Little Clam Lake Outlet (n=22)								P-6 - Inflow to Bagsverd Lake (n=24)							
		Minimum	Maximum	Average	Standard Deviation	25 th percentile	Median	75 th percentile	95 th percentile	Minimum	Maximum	Average	Standard Deviation	25 th percentile	Median	75 th percentile	95 th percentile
FIELD PARAMETERS																	
pH	pH units	4.23	7.58	6.41	0.82	6.07	6.51	6.94	7.50	5.73	7.63	6.73	0.42	6.50	6.84	7.00	7.20
Temperature	degrees Celsius	-1.5	22	8.4	8.3	0.10	6.4	17	21	-0.20	25	9.0	8.2	0.95	6.4	16	20
Conductivity	µS/cm	13	42	27	7.9	21	27	33	42	0.50	94	45	22	29	39	58	84
Dissolved Oxygen (DO)	mg/L	2.6	16	7.3	3.5	4.4	6.9	8.6	13.2	0.87	12	5.7	3.6	2.9	5.1	9.3	11.3
GENERAL PARAMETERS																	
Lab pH	pH units	5.72	6.96	6.32	0.34	6.10	6.29	6.55	6.80	6.16	7.40	6.69	0.28	6.54	6.66	6.83	7.10
Alkalinity	mg/L as CaCO ₃	<5	21	11	3.4	9.0	10	13	14	9.0	46	26	11	18	25	36	43
Electrical Conductivity (EC)	µS/cm	25	46	37	5.3	34	36	41	46	34	100	64	19	50	60	79	100
Total Dissolved Solids (TDS)	mg/L	26	94	48	19	35	44	48	93	32	120	64	17	56	62	69	92
Total Suspended Solids (TSS)	mg/L	<1	6.0	2.2	2.1	0.50	0.50	5.0	5.0	0.50	20	2.1	4.3	0.50	0.50	1.3	9.6
Total Hardness	mg/L as CaCO ₃	10.9	28	18	4.3	16	17	19	27	16	53	31	9	24	30	35	45
Dissolved Organic Carbon (DOC)	mg/L	7.5	34	14	6.5	9.6	11	14	27	8.6	16	12	1.9	11	12	13	15
MAJOR IONS																	
Calcium (Ca)	mg/L	3.6	10	6.0	1.5	5.2	5.5	6.3	9.3	5.1	16	9.4	2.8	7.2	9.2	11	14
Magnesium (Mg)	mg/L	0.47	1.1	0.72	0.14	0.63	0.69	0.82	0.98	0.9	3	1.8	0.51	1.5	1.7	2.2	2.5
Potassium (K)	mg/L	<0.05	0.55	0.26	0.13	0.16	0.27	0.32	0.52	0.025	0.41	0.20	0.10	0.13	0.20	0.26	0.36
Sodium (Na)	mg/L	0.63	0.89	0.73	0.069	0.68	0.71	0.77	0.85	0.69	2.5	1.0	0.34	0.85	0.97	1.1	1.3
Chloride (Cl)	mg/L	0.12	0.43	0.30	0.068	0.27	0.31	0.35	0.41	0.11	0.64	0.34	0.14	0.24	0.31	0.42	0.63
Fluoride (F)	mg/L	<0.05	<0.05	<0.05	-	<0.05	<0.05	<0.05	<0.05	<0.050	<0.050	<0.05	-	<0.05	<0.05	<0.05	<0.05
Sulphate (SO ₄)	mg/L	0.16	4.1	2.7	1.1	2.5	3.0	3.3	3.7	1.0	4.8	2.6	1.3	1.4	3.0	3.6	4.7
METALS																	
Aluminum (Al)	mg/L	0.016	0.12	0.056	0.028	0.034	0.051	0.066	0.108	0.0090	0.17	0.057	0.039	0.025	0.051	0.090	0.12
Antimony (Sb)	mg/L	<0.0060	<0.0060	<0.0060	-	<0.0060	<0.0060	<0.0060	<0.0060	<0.0060	<0.0060	<0.0060	-	<0.0060	<0.0060	<0.0060	<0.0060
Arsenic (As)	mg/L	<0.0030	<0.0030	<0.0030	-	<0.0030	<0.0030	<0.0030	<0.0030	<0.0030	<0.0030	<0.0030	-	<0.0030	<0.0030	<0.0030	<0.0030
Barium (Ba)	mg/L	0.0020	0.0080	0.0045	0.0014	0.0040	0.0040	0.0050	0.0070	0.0010	0.23	0.014	0.045	0.0030	0.0030	0.0050	0.011
Beryllium (Be)	mg/L	<0.0010	<0.0010	<0.0010	-	<0.0010	<0.0010	<0.0010	<0.0010	<0.0010	<0.0010	<0.0010	-	<0.0010	<0.0010	<0.0010	<0.0010
Boron (B)	mg/L	<0.01	<0.01	<0.01	-	<0.01	<0.01	<0.01	<0.01	<0.01	<0.01	<0.01	-	<0.01	<0.01	<0.01	<0.01
Cadmium (Cd)	mg/L	<0.00002	0.000050	0.000037	0.000019	0.000010	0.000050	0.000050	0.000050	<0.000020	<0.00010	0.000038	0.000018	0.000010	0.000050	0.000050	0.000050
Chromium (Cr)	mg/L	<0.003	<0.003	<0.003	-	<0.003	<0.003	<0.003	<0.003	<0.003	<0.003	<0.003	-	<0.003	<0.003	<0.003	<0.003
Cobalt (Co)	mg/L	<0.00050	0.0011	0.00036	0.00025	0.00025	0.00025	0.00025	0.00090	<0.00050	0.00090	0.00032	0.00020	0.00025	0.00025	0.00025	0.00087
Copper (Cu)	mg/L	0.00050	0.0010	0.00092	0.00016	0.0010	0.0010	0.0010	0.0010	0.00030	0.0010	0.00091	0.00019	0.0010	0.0010	0.0010	0.0010
Iron (Fe)	mg/L	0.020	0.46	0.14	0.13	0.045	0.086	0.17	0.43	0.043	2.7	0.45	0.66	0.097	0.17	0.36	1.8
Lead (Pb)	mg/L	0.00050	0.00050	0.00042	0.00014	0.00043	0.00050	0.00050	0.00050	<0.00010	<0.0010	0.00037	0.00020	0.000050	0.00050	0.00050	0.00050
Manganese (Mn)	mg/L	0.0030	0.15	0.038	0.047	0.0080	0.013	0.055	0.15	0.0030	2.8	0.41	0.74	0.017	0.052	0.21	1.8
Mercury (Hg)	mg/L	0.0000095	0.000050	0.000036	0.000022	0.000048	0.000050	0.000050	0.000050	0.0000095	<0.0001	0.000036	0.000022	0.0000073	0.000050	0.000050	0.000050
Molybdenum (Mo)	mg/L	<0.0020	<0.0020	<0.0020	-	<0.0020	<0.0020	<0.0020	<0.0020	<0.0020	<0.0020	<0.0020	-	<0.0020	<0.0020	<0.0020	<0.0020
Nickel (Ni)	mg/L	<0.0030	<0.0030	<0.0030	-	<0.0030	<0.0030	<0.0030	<0.0030	<0.0030	<0.0030	<0.0030	-	<0.0030	<0.0030	<0.0030	<0.0030
Selenium (Se)	mg/L	<0.00001	<0.004	0.0014	0.00091	0.000050	0.0020	0.0020	0.0020	<0.00010	<0.0040	0.0014	0.00089	0.000050	0.0020	0.0020	0.0020
Silver (Ag)	mg/L	<0.00001	<0.00010	0.000036	0.000021	0.000050	0.000050	0.000050	0.000050	<0.000010	<0.00010	0.000037	0.000020	0.0000088	0.000050	0.000050	0.000050
Strontium (Sr)	mg/L	0.0080	0.030	0.014	0.0043	0.012	0.013	0.016	0.018	0.011	0.034	0.021	0.0064	0.017	0.022	0.025	0.033
Thallium (Tl)	mg/L	<0.000010	<0.0003	0.00010	0.000068	0.000050	0.00015	0.00015	0.00015	<0.000010	<0.00030	0.00011	0.000066	0.0000050	0.00015	0.00015	0.00015
Titanium (Ti)	mg/L	<0.0020	<0.0020	<0.0020	-	<0.0020	<0.0020	<0.0020	<0.0020	<0.0020	<0.0020	<0.0020	-	<0.0020	<0.0020	<0.0020	<0.0020
Tungsten (W)	mg/L	<0.010	<0.010	<0.010	-	<0.010	<0.010	<0.010	<0.010	<0.010	<0.010	<0.010	-	<0.010	<0.010	<0.010	<0.010
Uranium (U)	mg/L	<0.0020	<0.0020	<0.0020	-	<0.0020	<0.0020	<0.0020	<0.0020	<0.0020	<0.0020	<0.0020	-	<0.0020	<0.0020	<0.0020	<0.0020
Vanadium (V)	mg/L	<0.0020	<0.0020	<0.0020	-	<0.0020	<0.0020	<0.0020	<0.0020	<0.0020	<0.0020	<0.0020	-	<0.0020	<0.0020	<0.0020	<0.0020
Zinc (Zn)	mg/L	0.0025	0.014	0.0051	0.0037	0.0025	0.0025	0.0080	0.0110	0.0025	0.054	0.0098	0.014	0.0025	0.0025	0.0080	0.038
Zirconium (Zr)	mg/L	<0.0040	<0.0040	<0.0040	-	<0.0040	<0.0040	<0.0040	<0.0040	<0.0040	<0.0040	<0.0040	-	<0.0040	<0.0040	<0.0040	<0.0040
OTHER PARAMETERS																	
Total Cyanide	mg/L	<0.0020	<0.0020	<0.0020	-	<0.0020	<0.0020	<0.0020	<0.0020	<0.0020	<0.0020	<0.0020	-	<0.0020	<0.0020	<0.0020	<0.0020
Total Ammonia (NH ₃ + NH ₄)	mg/L as N	<0.02	0.16	0.026	0.036	0.010	0.010	0.018	0.089	<0.020	0.29	0.053	0.077	0.010	0.015	0.043	0.24
Un-ionized Ammonia (NH ₃)	mg/L	0.0000002	0.00014	0.000032	0.000044	0.000024	0.000011	0.000042	0.00013	0.0000015	0.00052	0.000069	0.00011	0.0000067	0.000019	0.000084	0.00024
Total Phosphorus (P)	mg/L	0.0090	0.050	0.019	0.013	0.010	0.010	0.029	0.050	0.0090	0.070	0.017	0.015	0.010	0.010	0.012	0.049

Notes:

Values with the less than sign ("<") indicate concentrations below the laboratory method detection limit.

For the purposes of statistical calculations, values less than the laboratory detection limit were assumed to be equal to one-half the detection limit.

Dashes ("-") indicate the statistic was not calculated.

⁽¹⁾ For sample locations where n=1, statistics were not calculated.

TABLE 6a
WATER QUALITY COMPARISON OF LAKES AND WATERCOURSES AFFECTED BY REALIGNMENT - BAGSVERD LAKE AND WEEDUCK LAKE
CÔTÉ GOLD PROJECT

Parameter	Unit	BPD - Bagsverd Creek, near Bagsverd Lake Outflow (n=23)								WD - Weeduck Lake Outlet (n=30)							
		Minimum	Maximum	Average	Standard Deviation	25 th percentile	Median	75 th percentile	95 th percentile	Minimum	Maximum	Average	Standard Deviation	25 th percentile	Median	75 th percentile	95 th percentile
FIELD PARAMETERS																	
pH	pH units	6.13	7.77	7.12	0.39	7.09	7.15	7.34	7.50	5.56	8.14	7.12	0.54	6.84	7.22	7.50	7.90
Temperature	degrees Celsius	-0.44	24	9.7	8.4	1.5	8.0	18	22	-0.20	24	8.7	8.9	0.77	5.8	18	24
Conductivity	µS/cm	23	58	41	10	34	37	50	56	16	42	28	6.8	23	25	33	39
Dissolved Oxygen (DO)	mg/L	5.6	16	10.2	2.5	8.2	10.2	12	14	1.2	19	8.7	3.7	7.2	8.3	11	13
GENERAL PARAMETERS																	
Lab pH	pH units	6.15	7.34	6.77	0.27	6.68	6.76	6.94	7.20	5.80	7.26	6.60	0.40	6.31	6.72	6.93	7.10
Alkalinity	mg/L as CaCO ₃	17	26	21	2.7	20	22	24	25	2.5	15	12	2.3	12	13	13	14
Electrical Conductivity (EC)	µS/cm	48	68	56	5.4	53	56	58	67	26	45	39	3.5	37	38	40	44
Total Dissolved Solids (TDS)	mg/L	36	80	51	10	44	50	58	62	10	82	36	15	28	35	44	55
Total Suspended Solids (TSS)	mg/L	0.50	5.0	2.1	2.0	0.50	1.0	4.5	5.0	0.50	5.0	2.9	2.0	0.63	3.0	5.0	5.0
Total Hardness	mg/L as CaCO ₃	nc	33	26	6.2	25	27	29	31	12	21	18	1.7	17	17	18	20
Dissolved Organic Carbon (DOC)	mg/L	6.7	12	9.2	1.2	8.3	8.9	10	11	6.1	173	14	30	7.8	8.3	9.7	13.9
MAJOR IONS																	
Calcium (Ca)	mg/L	7.6	11	8.8	0.84	8.0	8.8	9.5	10	3.5	6.2	5.2	0.51	4.9	5.2	5.4	5.9
Magnesium (Mg)	mg/L	1.1	1.6	1.3	0.14	1.2	1.3	1.5	1.5	0.77	1.4	1.1	0.12	1.1	1.1	1.2	1.3
Potassium (K)	mg/L	0.19	0.36	0.28	0.041	0.26	0.28	0.32	0.35	0.31	0.52	0.40	0.057	0.37	0.39	0.44	0.52
Sodium (Na)	mg/L	0.62	0.91	0.73	0.070	0.68	0.71	0.77	0.85	0.54	0.85	0.69	0.076	0.63	0.66	0.75	0.83
Chloride (Cl)	mg/L	0.21	0.44	0.31	0.061	0.26	0.31	0.35	0.41	0.20	0.52	0.33	0.093	0.27	0.32	0.37	0.51
Fluoride (F)	mg/L	<0.05	<0.05	<0.05	-	<0.05	<0.05	<0.05	<0.05	<0.05	<0.05	<0.05	-	<0.05	<0.05	<0.05	<0.05
Sulphate (SO ₄)	mg/L	2.4	3.6	3.0	0.24	2.9	3.0	3.1	3.3	1.7	2.8	2.3	0.27	2.1	2.3	2.4	2.7
METALS																	
Aluminum (Al)	mg/L	0.0060	0.035	0.016	0.0078	0.0090	0.015	0.019	0.030	0.0020	0.029	0.010	0.0062	0.0060	0.0090	0.013	0.022
Antimony (Sb)	mg/L	<0.0060	<0.0060	<0.0060	-	<0.0060	<0.0060	<0.0060	<0.0060	<0.006	<0.006	<0.006	-	<0.006	<0.006	<0.006	<0.006
Arsenic (As)	mg/L	<0.0030	<0.0030	<0.0030	-	<0.0030	<0.0030	<0.0030	<0.0030	<0.003	<0.003	<0.003	-	<0.003	<0.003	<0.003	<0.003
Barium (Ba)	mg/L	0.0040	0.0070	0.0051	0.00068	0.0050	0.0050	0.0050	0.0060	0.0030	0.0060	0.0051	0.00081	0.0050	0.0050	0.0060	0.0060
Beryllium (Be)	mg/L	<0.0010	<0.0010	<0.0010	-	<0.0010	<0.0010	<0.0010	<0.0010	<0.001	<0.001	<0.001	-	<0.001	<0.001	<0.001	<0.001
Boron (B)	mg/L	<0.01	<0.01	<0.01	-	<0.01	<0.01	<0.01	<0.01	<0.01	<0.01	<0.01	-	<0.01	<0.01	<0.01	<0.01
Cadmium (Cd)	mg/L	0.000010	0.000050	0.000038	0.000018	0.000010	0.000050	0.000050	0.000050	0.000010	0.000050	0.000041	0.000017	0.000050	0.000050	0.000050	0.000050
Chromium (Cr)	mg/L	<0.003	<0.003	<0.003	-	<0.003	<0.003	<0.003	<0.003	<0.003	<0.003	<0.003	-	<0.003	<0.003	<0.003	<0.003
Cobalt (Co)	mg/L	<0.0005	<0.0005	<0.0005	-	<0.0005	<0.0005	<0.0005	<0.0005	<0.0005	<0.0005	<0.0005	-	<0.0005	<0.0005	<0.0005	<0.0005
Copper (Cu)	mg/L	0.00020	0.0010	0.00083	0.00026	0.00060	0.0010	0.0010	0.0010	0.00050	0.0010	0.00092	0.00016	0.0010	0.0010	0.0010	0.0010
Iron (Fe)	mg/L	0.0050	0.090	0.018	0.020	0.0050	0.0050	0.023	0.051	0.0050	0.15	0.036	0.035	0.0050	0.025	0.052	0.090
Lead (Pb)	mg/L	0.000050	0.00050	0.00037	0.00020	0.000075	0.00050	0.00050	0.00050	0.000050	0.00050	0.00040	0.00019	0.00050	0.00050	0.00050	0.00050
Manganese (Mn)	mg/L	0.0090	0.07	0.027	0.014	0.014	0.025	0.033	0.048	0.0040	0.13	0.041	0.036	0.016	0.028	0.053	0.116
Mercury (Hg)	mg/L	0.0000095	0.000050	0.000035	0.000022	0.0000048	0.000050	0.000050	0.000050	0.0000095	0.000050	0.000038	0.000021	0.000050	0.000050	0.000050	0.000050
Molybdenum (Mo)	mg/L	<0.0020	<0.0020	<0.0020	-	<0.0020	<0.0020	<0.0020	<0.0020	<0.002	<0.002	<0.002	-	<0.002	<0.002	<0.002	<0.002
Nickel (Ni)	mg/L	<0.0030	<0.0030	<0.0030	-	<0.0030	<0.0030	<0.0030	<0.0030	<0.003	<0.003	<0.003	-	<0.003	<0.003	<0.003	<0.003
Selenium (Se)	mg/L	0.000050	0.0020	0.0014	0.00090	0.000050	0.0020	0.0020	0.0020	0.000050	0.0020	0.0015	0.00082	0.0020	0.0020	0.0020	0.0020
Silver (Ag)	mg/L	0.0000050	0.000050	0.000036	0.000021	0.0000050	0.000050	0.000050	0.000050	0.0000050	0.000050	0.000040	0.000019	0.000050	0.000050	0.000050	0.000050
Strontium (Sr)	mg/L	0.015	0.026	0.020	0.0027	0.018	0.020	0.022	0.024	0.0080	0.016	0.013	0.0016	0.012	0.013	0.014	0.015
Thallium (Tl)	mg/L	0.0000050	0.00015	0.00011	0.000065	0.000018	0.00015	0.00015	0.00015	0.0000050	0.00015	0.00012	0.000061	0.00015	0.00015	0.00015	0.00015
Titanium (Ti)	mg/L	<0.0020	<0.0020	<0.0020	-	<0.0020	<0.0020	<0.0020	<0.0020	<0.002	<0.002	<0.002	-	<0.002	<0.002	<0.002	<0.002
Tungsten (W)	mg/L	<0.010	<0.010	<0.010	-	<0.010	<0.010	<0.010	<0.010	<0.01	<0.01	<0.01	-	<0.01	<0.01	<0.01	<0.01
Uranium (U)	mg/L	<0.0020	<0.0020	<0.0020	-	<0.0020	<0.0020	<0.0020	<0.0020	<0.002	<0.002	<0.002	-	<0.002	<0.002	<0.002	<0.002
Vanadium (V)	mg/L	<0.0020	<0.0020	<0.0020	-	<0.0020	<0.0020	<0.0020	<0.0020	<0.002	<0.002	<0.002	-	<0.002	<0.002	<0.002	<0.002
Zinc (Zn)	mg/L	0.0025	0.033	0.0054	0.0072	0.0025	0.0025	0.0025	0.0159	0.0025	0.025	0.0073	0.0072	0.0025	0.0025	0.010	0.024
Zirconium (Zr)	mg/L	<0.0040	<0.0040	<0.0040	-	<0.0040	<0.0040	<0.0040	<0.0040	<0.004	<0.004	<0.004	-	<0.004	<0.004	<0.004	<0.004
OTHER PARAMETERS																	
Total Cyanide	mg/L	<0.0020	<0.0020	<0.0020	-	<0.0020	<0.0020	<0.0020	<0.0020	<0.002	<0.002	<0.002	-	<0.002	<0.002	<0.002	<0.002
Total Ammonia (NH ₃ + NH ₄)	mg/L as N	0.010	0.25	0.055	0.073	0.010	0.010	0.070	0.210	0.010	0.070	0.028	0.021	0.010	0.015	0.048	0.066
Un-ionized Ammonia (NH ₃)	mg/L	0.0000093	0.0010	0.00013	0.00022	0.000019	0.00004	0.00013	0.00055	0.0000019	0.00078	0.00011	0.00018	0.000020	0.000028	0.00012	0.00045
Total Phosphorus (P)	mg/L	0.0080	0.050	0.016	0.011	0.010	0.010	0.020	0.039	0.0030	0.090	0.016	0.017	0.010	0.010	0.010	0.046

Notes:

Values with the less than sign ("<") indicate concentrations below the laboratory method detection limit.

For the purposes of statistical calculations, values less than the laboratory detection limit were assumed to be equal to one-half the detection limit.

Dashes ("-") indicate the statistic was not calculated.

⁽¹⁾ For sample locations where n=1, statistics were not calculated.

TABLE 6a
WATER QUALITY COMPARISON OF LAKES AND WATERCOURSES AFFECTED BY REALIGNMENT - BAGSVERD LAKE AND UNNAMED LAKE #2
CÔTÉ GOLD PROJECT

Parameter	Unit	BPD - Bagsverd Creek, near Bagsverd Lake Outflow (n=23)								L-2 - Inflow to Bagsverd Creek (n=24)							
		Minimum	Maximum	Average	Standard Deviation	25 th percentile	Median	75 th percentile	95 th percentile	Minimum	Maximum	Average	Standard Deviation	25 th percentile	Median	75 th percentile	95 th percentile
FIELD PARAMETERS																	
pH	pH units	6.13	7.77	7.12	0.39	7.09	7.15	7.34	7.50	5.63	7.50	6.64	0.46	6.41	6.79	6.97	7.10
Temperature	degrees Celsius	-0.44	24	9.7	8.4	1.5	8.0	18	22	-0.53	26	9.0	8.9	1.2	4.3	18	24
Conductivity	µS/cm	23	58	41	10	34	37	50	56	19	41	25	6.0	21	23	29	37
Dissolved Oxygen (DO)	mg/L	5.6	16	10.2	2.5	8.2	10.2	12	14	6.3	14	10.1	2.1	8.7	9.7	12	13
GENERAL PARAMETERS																	
Lab pH	pH units	6.15	7.34	6.77	0.27	6.68	6.76	6.94	7.20	5.92	6.91	6.43	0.25	6.21	6.48	6.60	6.80
Alkalinity	mg/L as CaCO ₃	17	26	21	2.7	20	22	24	25	6.0	25	11	3.4	9.0	11	11	13
Electrical Conductivity (EC)	µS/cm	48	68	56	5.4	53	56	58	67	28	66	38	6.9	35	37	38	44
Total Dissolved Solids (TDS)	mg/L	36	80	51	10	44	50	58	62	20	68	48	11	42	48	54	65
Total Suspended Solids (TSS)	mg/L	0.50	5.0	2.1	2.0	0.50	1.0	4.5	5.0	0.50	5.0	2.8	1.8	1.0	3.0	5.0	5.0
Total Hardness	mg/L as CaCO ₃	nc	33	26	6.2	25	27	29	31	nc	22	17	4.1	17	18	19	21
Dissolved Organic Carbon (DOC)	mg/L	6.7	12	9.2	1.2	8.3	8.9	10	11	9.2	20	14	2.5	13	14	15	19
MAJOR IONS																	
Calcium (Ca)	mg/L	7.6	11	8.8	0.84	8.0	8.8	9.5	10	3.9	5.9	4.9	0.54	4.6	4.9	5.3	5.8
Magnesium (Mg)	mg/L	1.1	1.6	1.3	0.14	1.2	1.3	1.5	1.5	1.1	1.7	1.4	0.15	1.3	1.4	1.5	1.6
Potassium (K)	mg/L	0.19	0.36	0.28	0.041	0.26	0.28	0.32	0.35	0.18	0.52	0.28	0.068	0.24	0.27	0.28	0.38
Sodium (Na)	mg/L	0.62	0.91	0.73	0.070	0.68	0.71	0.77	0.85	0.80	1.1	0.89	0.069	0.84	0.88	0.92	1.01
Chloride (Cl)	mg/L	0.21	0.44	0.31	0.061	0.26	0.31	0.35	0.41	0.14	0.40	0.29	0.071	0.26	0.30	0.35	0.38
Fluoride (F)	mg/L	<0.05	<0.05	<0.05	-	<0.05	<0.05	<0.05	<0.05	<0.05	<0.05	<0.05	-	<0.05	<0.05	<0.05	<0.05
Sulphate (SO ₄)	mg/L	2.4	3.6	3.0	0.24	2.9	3.0	3.1	3.3	2.1	3.2	2.6	0.30	2.4	2.6	2.8	3.2
METALS																	
Aluminum (Al)	mg/L	0.0060	0.035	0.016	0.0078	0.0090	0.015	0.019	0.030	0.031	0.19	0.11	0.043	0.080	0.098	0.14	0.17
Antimony (Sb)	mg/L	<0.0060	<0.0060	<0.0060	-	<0.0060	<0.0060	<0.0060	<0.0060	<0.0060	<0.0060	<0.0060	-	<0.0060	<0.0060	<0.0060	<0.0060
Arsenic (As)	mg/L	<0.0030	<0.0030	<0.0030	-	<0.0030	<0.0030	<0.0030	<0.0030	<0.0030	<0.0030	<0.0030	-	<0.0030	<0.0030	<0.0030	<0.0030
Barium (Ba)	mg/L	0.0040	0.0070	0.0051	0.00068	0.0050	0.0050	0.0050	0.0060	0.0030	0.0060	0.0042	0.00069	0.0040	0.0040	0.0043	0.0050
Beryllium (Be)	mg/L	<0.0010	<0.0010	<0.0010	-	<0.0010	<0.0010	<0.0010	<0.0010	<0.0010	<0.0010	<0.0010	-	<0.0010	<0.0010	<0.0010	<0.0010
Boron (B)	mg/L	<0.01	<0.01	<0.01	-	<0.01	<0.01	<0.01	<0.01	<0.01	<0.01	<0.01	-	<0.01	<0.01	<0.01	0.0050
Cadmium (Cd)	mg/L	0.000010	0.000050	0.000038	0.000018	0.000010	0.000050	0.000050	0.000050	0.000010	0.000050	0.000038	0.000018	0.000010	0.000050	0.000050	0.000050
Chromium (Cr)	mg/L	<0.003	<0.003	<0.003	-	<0.003	<0.003	<0.003	<0.003	<0.003	<0.003	<0.003	-	<0.003	<0.003	<0.003	<0.003
Cobalt (Co)	mg/L	<0.0005	<0.0005	<0.0005	-	<0.0005	<0.0005	<0.0005	<0.0005	<0.0005	<0.0005	<0.0005	-	<0.0005	<0.0005	<0.0005	<0.0005
Copper (Cu)	mg/L	0.00020	0.0010	0.00083	0.00026	0.00060	0.0010	0.0010	0.0010	0.00060	0.0010	0.00093	0.00012	0.00090	0.0010	0.0010	0.0010
Iron (Fe)	mg/L	0.0050	0.090	0.018	0.020	0.0050	0.0050	0.023	0.051	0.12	0.64	0.29	0.14	0.19	0.26	0.32	0.58
Lead (Pb)	mg/L	0.000050	0.00050	0.00037	0.00020	0.000075	0.00050	0.00050	0.00050	0.00010	0.00050	0.00041	0.00015	0.00028	0.00050	0.00050	0.00050
Manganese (Mn)	mg/L	0.0090	0.07	0.027	0.014	0.014	0.025	0.033	0.048	0.0090	0.035	0.022	0.0072	0.017	0.021	0.028	0.033
Mercury (Hg)	mg/L	0.0000095	0.000050	0.000035	0.000022	0.0000048	0.000050	0.000050	0.000050	0.0000095	0.000050	0.000036	0.000021	0.0000068	0.000050	0.000050	0.000050
Molybdenum (Mo)	mg/L	<0.0020	<0.0020	<0.0020	-	<0.0020	<0.0020	<0.0020	<0.0020	<0.0020	<0.0020	<0.0020	-	<0.0020	<0.0020	<0.0020	<0.0020
Nickel (Ni)	mg/L	<0.0030	<0.0030	<0.0030	-	<0.0030	<0.0030	<0.0030	<0.0030	<0.0030	<0.0030	<0.0030	-	<0.0030	<0.0030	<0.0030	<0.0030
Selenium (Se)	mg/L	0.000050	0.0020	0.0014	0.00090	0.000050	0.0020	0.0020	0.0020	0.000050	0.0020	0.0014	0.00088	0.00088	0.0020	0.0020	0.0020
Silver (Ag)	mg/L	0.0000050	0.000050	0.000036	0.000021	0.0000050	0.000050	0.000050	0.000050	0.0000050	0.000050	0.000038	0.000019	0.000020	0.000050	0.000050	0.000050
Strontium (Sr)	mg/L	0.015	0.026	0.020	0.0027	0.018	0.020	0.022	0.024	0.011	0.019	0.014	0.0018	0.013	0.015	0.015	0.018
Thallium (Tl)	mg/L	0.0000050	0.00015	0.00011	0.000065	0.000018	0.00015	0.00015	0.00015	0.0000050	0.00015	0.00011	0.000066	0.0000050	0.00015	0.00015	0.00015
Titanium (Ti)	mg/L	<0.0020	<0.0020	<0.0020	-	<0.0020	<0.0020	<0.0020	<0.0020	0.0010	0.0020	0.0011	0.00028	0.0010	0.0010	0.0010	0.0019
Tungsten (W)	mg/L	<0.010	<0.010	<0.010	-	<0.010	<0.010	<0.010	<0.010	<0.010	<0.010	<0.010	-	<0.010	<0.010	<0.010	<0.010
Uranium (U)	mg/L	<0.0020	<0.0020	<0.0020	-	<0.0020	<0.0020	<0.0020	<0.0020	<0.0020	<0.0020	<0.0020	-	<0.0020	<0.0020	<0.0020	<0.0020
Vanadium (V)	mg/L	<0.0020	<0.0020	<0.0020	-	<0.0020	<0.0020	<0.0020	<0.0020	<0.0020	<0.0020	<0.0020	-	<0.0020	<0.0020	<0.0020	<0.0020
Zinc (Zn)	mg/L	0.0025	0.033	0.0054	0.0072	0.0025	0.0025	0.0025	0.0159	0.0025	0.058	0.0084	0.015	0.0025	0.0025	0.0034	0.0489
Zirconium (Zr)	mg/L	<0.0040	<0.0040	<0.0040	-	<0.0040	<0.0040	<0.0040	<0.0040	<0.0040	<0.0040	<0.0040	-	<0.0040	<0.0040	<0.0040	<0.0040
OTHER PARAMETERS																	
Total Cyanide	mg/L	<0.0020	<0.0020	<0.0020	-	<0.0020	<0.0020	<0.0020	<0.0020	<0.0020	<0.0020	<0.0020	-	<0.0020	<0.0020	<0.0020	<0.0020
Total Ammonia (NH ₃ + NH ₄)	mg/L as N	0.010	0.25	0.055	0.073	0.010	0.010	0.070	0.210	0.010	0.080	0.024	0.019	0.010	0.020	0.030	0.060
Un-ionized Ammonia (NH ₃)	mg/L	0.0000093	0.0010	0.00013	0.00022	0.000019	0.00004	0.00013	0.00055	0.0000080	0.00059	0.00011	0.00018	0.0000056	0.000026	0.00012	0.00048
Total Phosphorus (P)	mg/L	0.0080	0.050	0.016	0.011	0.010	0.010	0.020	0.039	0.0070	0.070	0.019	0.014	0.010	0.010	0.023	0.040

Notes:

Values with the less than sign ("<") indicate concentrations below the laboratory method detection limit.

For the purposes of statistical calculations, values less than the laboratory detection limit were assumed to be equal to one-half the detection limit.

Dashes ("-") indicate the statistic was not calculated.

⁽¹⁾ For sample locations where n=1, statistics were not calculated.

TABLE 7a
95TH PERCENTILE CONCENTRATIONS OF UPDATED BASELINE DATASET - MOLLIE RIVER WATERSHED
CÔTÉ GOLD PROJECT

Parameter	Unit	CHLK-LS Chester Lake (Lake Station)	CHLK Chester Lake Outlet (CHLK)	P-2 Drainage from Beaver Pond	P-1 Intermittent Watercourse ⁽¹⁾	P-5 Seasonal Pond	CM-LS Clam Lake	CM Culvert Road Crossing of Clam Lake	CL Côté Lake Outlet	WD Weeduck Lake Outlet	MP Inflow to Three Duck Lakes	P7 Inflow to Three Ducks Lakes	3D-LS1 Three Duck Lakes (Upper) (Lake Station)	3D-LS2 Three Duck Lakes (Lower) (Lake Station)	3D-c Three Ducks Lakes, near Outlet	DEL-LS Delaney Lake (Lake Station)	DEL Delaney Lake ⁽¹⁾	P-4 Inflow to Mollie River	DIV-LS Dividing Lake	DIV Dividing Lake ⁽¹⁾
FIELD PARAMETERS																				
pH	pH units	8.15	7.50	6.60	6.87	6.80	7.70	7.90	7.40	7.90	7.00	6.91	8.05	7.80	7.80	6.88	5.78	6.87	7.50	6.80
Temperature	degrees Celsius	18	24	17	-0.10	18	21	25	22	24	21	20	20	20	22	22	8.3	14.9	19.9	5.5
Conductivity	µS/cm	90	45	65	26	49	131	48	44	39	65	60	99	135	40	45	14	31	139	40
Dissolved Oxygen (DO)	mg/L	10.2	14	11.2	8.1	10.9	70.0	16	15	13	12	12	11	11.0	16	9.6	12	13	13.0	11
GENERAL PARAMETERS																				
Lab pH	pH units	6.84	6.90	6.60	6.42	6.50	6.90	7.00	7.10	7.10	7.20	7.05	6.84	6.90	6.90	6.50	5.70	6.53	7.50	6.77
Alkalinity	mg/L as CaCO ₃	15	15	54	16	20	16	16	19	14	29	29	14	16	15	8.8	<5.0	13	39	18
Electrical Conductivity (EC)	µS/cm	48	50	105	51	57	48	50	54	44	87	67	47	80	51	37	21	47	113	64
Total Dissolved Solids (TDS)	mg/L	64	62	103	28	80	48	50	81	55	96	65	58	62	64	58	68	71	83	82
Total Suspended Solids (TSS)	mg/L	<10	5.0	11.8	<1.0	7.5	5.0	5.0	5.0	5.0	5.0	10.2	5.0	5.0	5.0	<10	2.0	4.9	5.0	0.50
Total Hardness	mg/L as CaCO ₃	21	24	53	24	28	22	22	26	20	40	33	24	25	24	20	10	25	50	0.00033
Dissolved Organic Carbon (DOC)	mg/L	15	16	30	16	33	10.6	10.0	16	13.9	21	15	15	16	16	27	15	26	13	11
MAJOR IONS																				
Calcium (Ca)	mg/L	6.6	7.6	16.9	7.6	9.0	7.2	7.3	8.2	5.9	12	10.0	7.4	7.8	7.4	5.9	3.1	7.7	16	9.0
Magnesium (Mg)	mg/L	1.1	1.3	2.7	1.3	1.4	1.03	1.04	1.4	1.3	2.1	1.9	1.3	1.4	1.4	1.2	0.59	1.3	2.8	1.6
Potassium (K)	mg/L	0.31	0.36	0.64	0.32	0.83	0.46	0.47	0.42	0.52	0.83	0.49	0.42	0.46	0.5	0.31	0.30	0.48	0.64	0.42
Sodium (Na)	mg/L	0.90	0.93	1.14	0.71	1.00	0.82	0.75	1.1	0.83	2.6	1.2	0.96	1.2	1.1	0.84	0.55	0.97	3.0	1.8
Chloride (Cl)	mg/L	0.36	0.41	0.49	0.33	0.67	0.43	0.44	1.01	0.51	4.1	1.3	0.62	0.73	0.9	0.49	0.22	0.34	5.7	2.6
Fluoride (F)	mg/L	<0.05	<0.05	<0.05	<0.05	<0.05	<0.05	<0.05	<0.05	<0.05	<0.05	<0.05	<0.05	<0.05	<0.05	<0.05	<0.05	<0.05	<0.05	0.025
Sulphate (SO ₄)	mg/L	3.0	3.6	3.8	2.8	3.1	3.8	4.8	3.7	2.7	8.1	3.5	3.3	3.2	3.4	2.6	1.9	3.8	4.0	3.1
METALS																				
Aluminum (Al)	mg/L	0.091	0.092	0.24	0.040	0.096	0.11	0.050	0.088	0.022	0.14	0.15	0.103	0.103	0.090	0.16	0.12	0.14	0.087	0.060
Antimony (Sb)	mg/L	<0.006	<0.006	<0.006	<0.006	<0.006	0.0030	<0.006	<0.006	<0.006	<0.006	<0.006	0.0030	0.0030	<0.003	<0.003	<0.006	<0.006	0.0030	0.0030
Arsenic (As)	mg/L	<0.003	<0.003	<0.003	<0.003	<0.003	<0.003	<0.003	<0.003	<0.003	<0.003	<0.003	<0.003	<0.003	<0.003	<0.003	<0.003	<0.003	<0.003	0.0015
Barium (Ba)	mg/L	0.0050	0.0057	0.0168	0.0090	0.0095	0.0070	0.0060	0.0066	0.0060	0.0107	0.0067	0.0061	0.0070	0.0060	0.0058	0.0030	0.0069	0.0047	0.0040
Beryllium (Be)	mg/L	<0.001	<0.001	<0.001	<0.001	<0.001	<0.001	<0.001	<0.001	<0.001	<0.001	<0.001	<0.001	<0.001	<0.001	<0.001	<0.001	<0.001	<0.001	0.00050
Boron (B)	mg/L	<0.01	<0.01	<0.01	<0.01	<0.01	<0.01	<0.01	<0.01	<0.01	<0.01	<0.01	<0.01	<0.01	<0.01	<0.01	<0.01	<0.01	<0.01	0.0050
Cadmium (Cd)	mg/L	0.000044	0.000050	0.000050	<0.0001	0.000050	0.000077	0.000050	0.000050	0.000050	0.000050	0.000050	0.000050	0.000083	0.000050	0.000048	<0.00002	0.000050	0.000050	0.000010
Chromium (Cr)	mg/L	<0.003	<0.003	<0.003	<0.003	<0.003	<0.003	<0.003	<0.003	<0.003	<0.003	<0.003	<0.003	0.0023	<0.003	<0.003	<0.003	<0.003	<0.003	0.0015
Cobalt (Co)	mg/L	<0.0005	<0.0005	0.00180	<0.0005	0.00096	<0.0005	<0.0005	<0.0005	<0.0005	0.00064	<0.0005	<0.0005	<0.0005	<0.0005	<0.0005	<0.0005	<0.0005	<0.0005	0.00025
Copper (Cu)	mg/L	0.0010	0.0010	0.0011	<0.002	0.0010	0.0018	0.0019	0.0024	0.0010	0.0050	0.0010	0.0028	0.0018	0.0011	0.00098	0.00090	0.0010	0.0011	0.00090
Iron (Fe)	mg/L	0.26	0.32	3.4	0.24	0.77	0.35	0.222	0.36	0.090	0.54	0.47	0.30	0.68	0.23	0.54	0.28	0.67	0.12	0.14
Lead (Pb)	mg/L	0.00046	0.00050	0.00050	<0.001	0.00050	0.000775	0.00050	0.00050	0.00050	0.00050	0.00050	0.00050	0.00050	0.00050	0.00059	0.00030	0.00050	0.00050	0.00010
Manganese (Mn)	mg/L	0.023	0.053	0.46	0.072	0.324	0.296	0.039	0.071	0.116	0.088	0.105	0.086	0.158	0.045	0.042	0.024	0.073	0.31	0.020
Mercury (Hg)	mg/L	0.000046	0.000050	0.000050	<0.0001	0.000050	0.000050	0.000050	0.000050	0.000050	0.000050	0.004915	0.0000500	0.0000500	0.000050	0.000047	0.0000099	0.000050	0.000050	0.0000079
Molybdenum (Mo)	mg/L	0.0010	<0.002	<0.002	<0.002	<0.002	<0.002	<0.002	<0.002	<0.002	<0.002	<0.002	0.0010	0.0010	<0.002	<0.002	<0.002	<0.002	0.0010	0.0010
Nickel (Ni)	mg/L	<0.003	<0.003	<0.003	<0.003	<0.003	<0.003	<0.003	<0.003	<0.003	<0.003	<0.003	0.0107	<0.003	<0.003	<0.003	<0.003	<0.003	<0.003	0.0015
Selenium (Se)	mg/L	0.0017	0.0020	0.0020	<0.004	0.0020	0.002000	0.0020	0.0020	0.0020	0.0020	0.0020	0.002000	0.002000	0.0020	0.0018	<0.0001	0.0020	0.00200	0.000050
Silver (Ag)	mg/L	0.000043	0.000050	0.000050	<0.0001	0.000050	0.000050	0.000050	0.000050	0.000050	0.000050	0.000050	0.000050	0.000050	0.000050	<0.00001	<0.00001	0.000050	0.000050	0.000050
Strontium (Sr)	mg/L	0.013	0.017	0.038	0.016	0.019	0.015	0.017	0.018	0.015	0.026	0.020	0.016	0.021	0.015	0.013	0.0070	0.019	0.020	0.015
Thallium (Tl)	mg/L	0.000128	0.00015	0.00015	<0.0003	0.00015	0.0001500	0.00015	0.00015	0.00015	0.00015	0.00015	0.0001500	0.000150	0.00015	0.000136	<0.00001	0.00015	0.00015	0.000050
Titanium (Ti)	mg/L	<0.002	<0.002	0.0055	<0.002	0.0043	<0.002	0.0018	0.0026	<0.002	0.0010	<0.002	<0.002	0.0021	<0.002	0.0019	<0.002	0.0030	<0.002	0.0010
Tungsten (W)	mg/L	<0.01	<0.01	<0.01	<0.01	<0.01	<0.01	<0.01	<0.01	<0.01	<0.01	<0.01	<0.01	<0.01	<0.01	<0.01	<0.01	<0.01	<0.01	0.0050
Uranium (U)	mg/L	<0.002	<0.002	<0.002	<0.002	<0.002	<0.002	<0.002	<0.002	<0.002	<0.002	<0.002	<0.002	<0.002	<0.002	<0.002	<0.002	<0.002	<0.002	0.0010
Vanadium (V)	mg/L	<0.002	<0.002	<0.002	<0.002	<0.002	<0.002	<0.002	<0.002	<0.002	<0.002	<0.002	<0.002	<0.002	<0.002	<0.002	<0.002	<0.002	<0.002	0.0010
Zinc (Zn)	mg/L	<0.005	0.040	0.040	<0.005	0.062	0.0113	0.0088	0.0182	0.024	0.107	0.1144	0.0082	<0.005	0.0434	0.021	<0.005	0.019	0.0233	0.0025
Zirconium (Zr)	mg/L	<0.004	<0.004	<0.004	<0.004	<0.004	<0.004	<0.004	<0.004	<0.004	<0.004	<0.004	0.0020	<0.004	<0.004	<0.004	<0.004	<0.004	<0.004	0.0020
OTHER PARAMETERS																				
Total Cyanide	mg/L	<0.002	<0.002	<0.002	<0.002	0.0025	0.0021	<0.002	<0.002	<0.002	<0.002	<0.002	<0.002	0.0120	<0.002	<0.002	<0.002	0.0027	0.0010	0.0010
Total Ammonia (NH ₃ + NH ₄)	mg/L as N	0.020	0.057	0.48	0.34	0.740	0.076	0.080	0.060	0.066	0.108	0.046	0.062	0.070	0.069	0.055	0.060	0.056	0.037	0.030
Un-ionized Ammonia (NH ₃)	mg/L	0.00063	0.000135	0.000110	0.00028	0.000109	0.00035	0.00030	0.000163	0.00045	0.003490	0.000038	0.00023	0.000135	0.000146	0.000036	0.000030	0.000020	0.000000	0.000025
Total Phosphorus (P)	mg/L	0.012	0.040	0.040	<0.02	0.073	0.014	0.040	0.030	0.046	0.050	0.030	0.025	0.022	0.040	0.015	0.025	0.033	0.019	0.022

Notes:

Values with the less than sign (" $<$ ") indicate concentrations below the laboratory method detection limit.

For the purposes of statistical calculations, values

TABLE 8a
95TH PERCENTILE CONCENTRATIONS OF UPDATED BASELINE DATASET - MESOMIKENDA LAKE WATERSHED
CÔTÉ GOLD PROJECT

Parameter	Unit	LCM Little Clam Lake Outlet	P-3 Inflow to Bagsverd Lake	P-6 Inflow to Bagsverd Lake	SL Schist Lake Outflow	BAG-LS1 Bagsverd Lake (Lake Station)	BPD Bagsverd Creek, near Bagsverd Lake Outflow	BL-a Bagsverd Creek	L-2 Inflow to Bagsverd Creek	BL-b Bagsverd Creek, near Neville Lake Inflow	WL-1 Wolf Lake Outlet	SR Somme River	NEV-LS Neville Lake (Lake Station)	NL Neville Lake Outflow	MESO-LS7 Mesomikenda Lake (Lake Station)	MESO-LS5 - Mesomikenda Lake (Lake Station)	MESO-LS4 Mesomikenda Lake (Lake Station)	MESO-LS2 Mesomikenda Lake (Lake Station)	MESO-OUT Mesomikenda Lake Outflow
FIELD PARAMETERS																			
pH	pH units	7.50	6.64	7.20	7.40	7.90	7.50	7.40	7.10	7.20	7.60	7.60	7.50	7.20	7.60	7.60	7.60	7.30	8.00
Temperature	degrees Celsius	21	15	20	21	21	22	20	24	20	23	20	20	23	19	18	19.3	18.7	21
Conductivity	µS/cm	42	32	84	55	109	56	52	37	55	45	43	136	42	142	89	87	65	53
Dissolved Oxygen (DO)	mg/L	13.2	15.3	11.3	14.4	11	14	16	13	16	15	13	12	16	14	13	12	12	18
GENERAL PARAMETERS																			
Lab pH	pH units	6.80	6.30	7.10	7.20	7.10	7.20	7.20	6.80	7.00	6.80	7.00	7.00	6.60	7.70	7.50	7.50	7.40	7.10
Alkalinity	mg/L as CaCO ₃	14	12	43	29	24	25	26	13	25	21	18	24	20	37	24	24	22	22
Electrical Conductivity (EC)	µS/cm	46	45	100	73	61	67	66	44	64	51	54	58	58	143	90	84	62	63
Total Dissolved Solids (TDS)	mg/L	93	74	92	58	56	62	75	65	90	63	60	126	60	101	68	88	60	73
Total Suspended Solids (TSS)	mg/L	5.0	3.0	9.6	5.0	5	5.0	5.0	5.0	5.0	8.2	5.0	5.0	2.9	5.0	5.0	5.0	5.0	3.4
Total Hardness	mg/L as CaCO ₃	27	22	45	33	29	31	33	21	32	24	24	26	27	46	34	31	27	29
Dissolved Organic Carbon (DOC)	mg/L	27	22	15	12	12	11	21	19	26	15	14	21	14	6.6	11.0	9.3	12.0	14.0
MAJOR IONS																			
Calcium (Ca)	mg/L	9.3	7.3	14	10.5	9.4	10	10.3	5.8	9.8	6.8	6.8	8.2	7.8	14	10.2	9.4	8.0	8.4
Magnesium (Mg)	mg/L	0.98	0.92	2.5	1.6	1.4	1.5	1.7	1.6	1.9	1.7	1.8	1.4	1.8	2.5	2.0	1.9	1.7	2.0
Potassium (K)	mg/L	0.52	0.42	0.36	0.38	0.33	0.35	0.39	0.38	0.37	0.40	0.38	0.30	0.33	0.54	0.44	0.43	0.36	0.39
Sodium (Na)	mg/L	0.85	1.0	1.3	0.81	0.75	0.85	0.87	1.01	0.93	1.09	1.1	1.00	0.98	9.8	5.0	4.4	1.5	1.5
Chloride (Cl)	mg/L	0.41	0.39	0.63	0.40	0.33	0.41	0.41	0.38	0.54	0.49	0.48	0.67	0.42	16	7.8	7.3	1.5	1.3
Fluoride (F)	mg/L	<0.05	<0.05	<0.05	<0.05	0.039	<0.05	<0.05	<0.05	<0.05	0.036	<0.05	<0.05	<0.05	<0.05	<0.05	<0.05	<0.05	<0.05
Sulphate (SO ₄)	mg/L	3.7	4.7	4.7	3.5	3.4	3.3	3.3	3.2	3.2	3.6	4.0	3.0	3.6	4.6	4.9	4.2	3.4	3.8
METALS																			
Aluminum (Al)	mg/L	0.11	0.16	0.12	0.041	0.045	0.030	0.094	0.17	0.11	0.10	0.11	0.17	0.096	0.031	0.044	0.073	0.066	0.090
Antimony (Sb)	mg/L	<0.0060	<0.0060	<0.0060	<0.0060	0.0030	<0.0060	<0.0060	<0.0060	<0.0060	<0.0060	<0.0060	0.0030	<0.0060	0.0030	0.0030	0.0030	0.0030	<0.0060
Arsenic (As)	mg/L	<0.0030	<0.0030	<0.0030	<0.0030	<0.0030	<0.0030	<0.0030	<0.0030	<0.0030	<0.0030	<0.0030	<0.0030	<0.0030	<0.0030	<0.0030	<0.0030	<0.0030	<0.0030
Barium (Ba)	mg/L	0.0070	0.0068	0.011	0.0080	0.0071	0.0060	0.0068	0.0050	0.0060	0.0050	0.0051	0.0098	0.0055	0.0040	0.0046	0.0040	0.0040	0.0050
Beryllium (Be)	mg/L	<0.0010	<0.0010	<0.0010	<0.0010	<0.0010	<0.0010	<0.0010	<0.0010	<0.0010	<0.0010	<0.0010	<0.0010	<0.0010	<0.0010	<0.0010	<0.0010	<0.0010	<0.0010
Boron (B)	mg/L	<0.01	<0.01	<0.01	<0.01	<0.01	<0.01	<0.01	0.0050	<0.01	<0.01	0.0050	<0.01	<0.01	<0.01	<0.01	<0.01	<0.01	<0.01
Cadmium (Cd)	mg/L	0.000050	0.000050	0.000050	0.000050	0.000050	0.000050	0.000050	0.000050	0.000050	0.000050	0.050	0.000050	0.000050	0.000050	0.000050	0.000050	0.000050	0.000050
Chromium (Cr)	mg/L	<0.003	<0.003	<0.003	<0.003	<0.003	<0.003	<0.003	<0.003	<0.003	<0.003	<0.003	<0.003	<0.003	<0.003	<0.003	<0.003	<0.003	<0.003
Cobalt (Co)	mg/L	0.00090	<0.0005	0.00087	<0.0005	<0.0005	<0.0005	<0.0005	<0.0005	<0.0005	<0.0005	<0.0005	0.0011	<0.0005	<0.0005	<0.0005	<0.0005	<0.0005	<0.0005
Copper (Cu)	mg/L	0.0010	0.0010	0.0010	0.0010	0.0015	0.0010	0.0010	0.0010	0.0010	0.0013	0.0010	0.0015	0.0011	0.00117	0.00155	0.00100	0.0012	0.0012
Iron (Fe)	mg/L	0.43	0.28	1.8	0.092	0.16	0.051	0.18	0.58	0.37	0.25	0.27	3.86	0.24	0.0300	0.033	0.057	0.118	0.16
Lead (Pb)	mg/L	0.00050	0.00050	0.00050	0.00050	0.00050	0.00050	0.00050	0.00050	0.00050	0.00050	0.00050	0.00074	0.00050	0.000500	0.02772	0.000500	0.000500	0.00050
Manganese (Mn)	mg/L	0.15	0.058	1.8	0.051	0.22	0.048	0.062	0.033	0.061	0.022	0.029	0.43	0.030	0.050	0.0050	0.0040	0.0111	0.0110
Mercury (Hg)	mg/L	0.000050	0.000050	0.000050	0.000050	0.000050	0.000050	0.000050	0.000050	0.000050	0.000050	0.000050	0.000050	0.000050	0.0000500	0.000050	0.000050	0.0000500	0.000050
Molybdenum (Mo)	mg/L	<0.0020	<0.0020	<0.0020	<0.0020	0.001	<0.0020	<0.0020	<0.0020	<0.0020	<0.0020	<0.0020	<0.0020	<0.0020	0.0010	0.0010	0.0010	0.0010	<0.0020
Nickel (Ni)	mg/L	<0.0030	<0.0030	<0.0030	<0.0030	<0.0030	<0.0030	<0.0030	<0.0030	<0.0030	<0.0030	<0.0030	<0.0030	<0.0030	<0.0030	<0.0030	<0.0030	<0.0030	<0.0030
Selenium (Se)	mg/L	0.0020	0.0020	0.0020	0.0020	0.0020	0.0020	0.0020	0.0020	0.0020	0.0020	0.0020	0.00200	0.0020	0.00200	0.00200	0.00200	0.002000	0.0020
Silver (Ag)	mg/L	0.000050	0.000050	0.000050	0.000050	0.000050	0.000050	0.000050	0.000050	0.000050	0.000050	0.000050	0.000050	0.000050	0.000050	0.000050	0.000050	0.000050	0.000050
Strontium (Sr)	mg/L	0.018	0.017	0.033	0.027	0.020	0.024	0.025	0.018	0.025	0.017	0.018	0.021	0.021	0.022	0.019	0.019	0.017	0.019
Thallium (Tl)	mg/L	0.00015	0.00015	0.00015	0.00015	0.00015	0.00015	0.00015	0.00015	0.00015	0.00015	0.00015	0.00015	0.00015	0.00015	0.00015	0.00015	0.00015	0.00015
Titanium (Ti)	mg/L	<0.0020	<0.0020	<0.0020	<0.0020	<0.0020	<0.0020	0.0010	0.0019	0.0020	<0.0020	<0.0020	0.0025	0.0020	<0.0020	<0.0020	<0.0020	<0.0020	0.0018
Tungsten (W)	mg/L	<0.010	<0.010	<0.010	<0.010	<0.010	<0.010	<0.010	<0.010	<0.010	<0.010	<0.010	<0.010	<0.010	<0.010	<0.010	<0.010	<0.010	<0.010
Uranium (U)	mg/L	<0.0020	<0.0020	<0.0020	<0.0020	<0.0020	<0.0020	<0.0020	<0.0020	<0.0020	<0.0020	<0.0020	<0.0020	<0.0020	<0.0020	<0.0020	<0.0020	<0.0020	<0.0020
Vanadium (V)	mg/L	<0.0020	<0.0020	<0.0020	<0.0020	<0.0020	<0.0020	<0.0020	<0.0020	<0.0020	<0.0020	<0.0020	0.0019	<0.0020	<0.0020	<0.0020	<0.0020	<0.0020	<0.0020
Zinc (Zn)	mg/L	0.0110	0.0089	0.038	0.0079	<0.005	0.0159	0.021	0.0489	0.0197	0.0077	0.0190	0.0169	0.0133	<0.005	<0.005	0.0110	<0.005	0.0063
Zirconium (Zr)	mg/L	<0.0040	<0.0040	<0.0040	<0.0040	<0.0040	<0.0040	<0.0040	<0.0040	<0.0040	<0.0040	<0.0040	<0.0040	<0.0040	<0.0040	<0.0040	<0.0040	<0.0040	<0.0040
OTHER PARAMETERS																			
Total Cyanide	mg/L	<0.0020	<0.0020	<0.0020	0.0010	<0.0020	<0.0020	<0.0020	<0.0020	<0.0020	<0.0020	0.0011	0.0010	<0.0020	<0.0020	<0.0020	<0.0020	<0.0020	<0.0020
Total Ammonia (NH ₃ + NH ₄)	mg/L as N	0.089	0.048	0.24	0.59	0.11	0.210	0.208	0.060	0.168	0.069	0.060	0.33	0.084	0.101	0.051	0.026	0.088	0.06
Un-ionized Ammonia (NH ₃)	mg/L	0.00013	0.000010	0.00024	0.00160	0.00027	0.00055	0.000170	0.00048	0.00011	0.00040	0.00012	0.00060	0.00036	0.00100	0.00011	0.00019	0.00027	0.00100
Total Phosphorus (P)	mg/L	0.050	0.025	0.049	0.030	0.035	0.039	0.039	0.040	0.040	0.045	0.021	0.093	0.026	0.012	0.051	0.029	0.014	0.027

Notes:
 Values with the less than sign ("<") indicate concentrations below the laboratory method detection limit.
 For the purposes of statistical calculations, values less than the laboratory detection limit were assumed to be equal to one-half the detection limit.
⁽¹⁾ For sample locations where n=1, statistics were not calculated.

**COMPARISON OF 95TH PERCENTILE BASELINE CONCENTRATIONS - ORIGINAL VERSUS UPDATED DATASETS
CÔTÉ GOLD PROJECT**

Parameter	Unit	95 th Percentile Concentrations - Original Baseline Dataset (to May 2013)	95 th Percentile Concentrations - Updated Baseline Dataset (to May 2014)
GENERAL PARAMETERS			
pH	pH units	7.2	7.1
Alkalinity	mg/L as CaCO ₃	29	27
Electrical Conductivity (EC)	µS/cm	80	75
Total Dissolved Solids (TDS)	mg/L	86	82
Total Suspended Solids (TSS)	mg/L	5.0	5.0
Total Hardness	mg/L as CaCO ₃	33	32
Dissolved Organic Carbon (DOC)	mg/L	18	20
MAJOR IONS			
Calcium (Ca)	mg/L	10	10
Magnesium (Mg)	mg/L	2.0	1.9
Potassium (K)	mg/L	0.49	0.47
Sodium (Na)	mg/L	1.3	1.5
Chloride (Cl)	mg/L	1.2	1.4
Fluoride (F)	mg/L	0.025	0.025
Sulphate (SO ₄)	mg/L	4.1	4.0
METALS			
Aluminum (Al)	mg/L	0.12	0.14
Antimony (Sb)	mg/L	0.0030	0.0030
Arsenic (As)	mg/L	0.0015	0.0015
Barium (Ba)	mg/L	0.0070	0.0070
Beryllium (Be)	mg/L	0.00050	0.00050
Boron (B)	mg/L	0.0050	0.0050
Cadmium (Cd)	mg/L	0.00005	0.000050
Chromium (Cr)	mg/L	0.0015	0.0015
Cobalt (Co)	mg/L	0.00025	0.00025
Copper (Cu)	mg/L	0.0010	0.0014
Iron (Fe)	mg/L	0.37	0.46
Lead (Pb)	mg/L	0.00050	0.00050
Manganese (Mn)	mg/L	0.088	0.12
Mercury (Hg)	mg/L	0.000050	0.000
Molybdenum (Mo)	mg/L	0.0010	0.0010
Nickel (Ni)	mg/L	0.0015	0.0015
Selenium (Se)	mg/L	0.0020	0.0020
Silver (Ag)	mg/L	0.000050	0.000050
Strontium (Sr)	mg/L	0.026	0.024
Thallium (Tl)	mg/L	0.00015	0.00015
Titanium (Ti)	mg/L	0.0020	0.0020
Tungsten (W)	mg/L	0.0050	0.0050
Uranium (U)	mg/L	0.0010	0.0010
Vanadium (V)	mg/L	0.0010	0.0010
Zinc (Zn)	mg/L	0.032	0.025
Zirconium (Zr)	mg/L	0.0020	0.0020
OTHER PARAMETERS			
Total Cyanide	mg/L	0.0010	0.0010
Total Ammonia (NH ₃ + NH ₄)	mg/L as N	0.21	0.18
Un-ionized Ammonia (NH ₃)	mg/L	0.00049	0.00043
Total Phosphorus (TP)	mg/L	0.05	0.040

Notes:

For the purposes of statistical calculations, values less than the laboratory detection limit were assumed to be equal to one-half the detection limit.

**COMPARISON OF 95TH PERCENTILE CONCENTRATIONS AND 75TH PERCENTILE CONCENTRATIONS OF UPDATED BASELINE DATASET
CÔTÉ GOLD PROJECT**

Parameter	Unit	95 th Percentile Concentrations - Updated Baseline Dataset	75 th Percentile Concentrations - Updated Baseline Dataset
GENERAL PARAMETERS			
pH	pH units	7.1	6.8
Alkalinity	mg/L as CaCO ₃	27	21
Electrical Conductivity (EC)	µS/cm	75	55
Total Dissolved Solids (TDS)	mg/L	82	58
Total Suspended Solids (TSS)	mg/L	5.0	5.0
Total Hardness	mg/L as CaCO ₃	32	26
Dissolved Organic Carbon (DOC)	mg/L	20	13
MAJOR IONS			
Calcium (Ca)	mg/L	10	8
Magnesium (Mg)	mg/L	1.9	1.5
Potassium (K)	mg/L	0.47	0.38
Sodium (Na)	mg/L	1.5	1.0
Chloride (Cl)	mg/L	1.4	0.5
Fluoride (F)	mg/L	0.025	0.025
Sulphate (SO ₄)	mg/L	4.0	3.3
METALS			
Aluminum (Al)	mg/L	0.14	0.08
Antimony (Sb)	mg/L	0.0030	0.0030
Arsenic (As)	mg/L	0.0015	0.0015
Barium (Ba)	mg/L	0.0070	0.0050
Beryllium (Be)	mg/L	0.00050	0.00050
Boron (B)	mg/L	0.0050	0.0050
Cadmium (Cd)	mg/L	0.000050	0.000050
Chromium (Cr)	mg/L	0.0015	0.0015
Cobalt (Co)	mg/L	0.00025	0.00025
Copper (Cu)	mg/L	0.0014	0.0010
Iron (Fe)	mg/L	0.46	0.21
Lead (Pb)	mg/L	0.00050	0.00050
Manganese (Mn)	mg/L	0.12	0.03
Mercury (Hg)	mg/L	0.000	0.000
Molybdenum (Mo)	mg/L	0.0010	0.0010
Nickel (Ni)	mg/L	0.0015	0.0015
Selenium (Se)	mg/L	0.0020	0.0020
Silver (Ag)	mg/L	0.000050	0.000050
Strontium (Sr)	mg/L	0.024	0.018
Thallium (Tl)	mg/L	0.00015	0.00015
Titanium (Ti)	mg/L	0.0020	0.0010
Tungsten (W)	mg/L	0.0050	0.0050
Uranium (U)	mg/L	0.0010	0.0010
Vanadium (V)	mg/L	0.0010	0.0010
Zinc (Zn)	mg/L	0.025	0.003
Zirconium (Zr)	mg/L	0.0020	0.0020
OTHER PARAMETERS			
Total Cyanide	mg/L	0.0010	0.0010
Total Ammonia (NH ₃ + NH ₄)	mg/L as N	0.18	0.05
Un-ionized Ammonia (NH ₃)	mg/L	0.00043	0.00010
Total Phosphorus (TP)	mg/L	0.040	0.020

Notes:

For the purposes of statistical calculations, values less than the laboratory detection limit were assumed to be equal to one-half the detection limit.

TABLE 11a
INPUTS TO LAKESHORE CAPACITY MODEL
CÔTÉ GOLD PROJECT

Lake	Northing	Easting	Runoff (m)	Surface Area (ha)	Catchment Area (ha)	% Wetland	% Cleared	Years of Spring Overturn Total Phosphorus Sampling	Number of Spring Overturn Total Phosphorus Samples	Average Measured Total Phosphorus in Spring Overturn Samples (mg/L)	Bottom Water Anoxic at End-of-Summer (y/n)	Lake Trout Presence /Absence (y/n)	Is the lake surface area greater than 25 ha? (y/n)
Mollie River Watershed													
Clam Lake	5267121	428624	0.300	80.0	391	0.7	6.0	2	2	0.009	y	n	y
Chester Lake	5265373	429883	0.300	98.0	3,345	0.7	13.8	1	1	0.010	y	n	y
Côté Lake	5267486	430164	0.300	18.0	527	1.1	2.2	0	0	n/a	y	n	n
Three Duck Lakes	5263621	432867	0.300	201.0	1,980	0.4	1.2	2	4	0.0152	y	n	y
Delaney Lake	5261878	431442	0.300	27.0	903	2.9	0.3	1	1	0.010	y	n	y
Dividing Lake	5260542	435933	0.300	129.0	2,609	2.2	13.9	2	2	0.0125	y	n	y
Mesomikenda Lake Watershed													
Little Clam Lake	5267779	428484	0.300	7.0	32	0	0	0	0	n/a	y	n	n
Schist Lake	5269771	428496	0.300	403.0	3,104	0.98	0.96	0	0	n/a	y	n	y
Bagsverd Lake	5270639	431343	0.300	215.0	1,169	0.64	2.57	2	2	0.0155	y	n	y
Unnamed Lake #2	5273456	428297	0.300	91.8	1,177	1.99	15.46	0	0	n/a	y	n	y
Unnamed Lake #1	5273426	428247	0.300	18.9	1,353	3.60	17.98	0	0	n/a	y	n	n
Schou Lake	5273828	423987	0.300	220.0	926	0.6	7.5	0	0	n/a	y	n	y
Wolf Lake	5278208	426646	0.300	104.0	11,672	1.6	5.3	0	0	n/a	y	n	y
Somme Lake	5280152	429894	0.300	68.0	7,133	1.2	11.3	0	0	n/a	y	n	y
Neville Lake	5278422	431497	0.300	108.0	4,906	4.4	7.9	2	2	0.015	y	n	y
Mesomikenda Lake	5283774	435026	0.300	1705.0	33,603	1.09	10.34	2	8	0.0975	y	y	y

Notes:

n/a - spring overturn total phosphorus data is not available

TABLE 12a
ANTHROPOGENIC INPUTS TO LAKESHORE CAPACITY MODEL
CÔTÉ GOLD PROJECT

Lake	Northing	Easting	Anthropogenic Source Classification								
			Permanent	Extended Seasonal	Seasonal	Resort	Trailer Parks	Youth Camps	Campgrounds/ Tent Trailers/ RV Parks	Vacant Lots of Record	Other (e.g., agriculture, urbanization, golf course)
Mollie River Watershed											
Clam Lake	5267121	428624	0	0	0	0	0	0	0	0	
Chester Lake	5265373	429883	0	0	0	0	0	0	0	0	
Côté Lake	5267486	430164	0	0	0	0	0	0	0	0	
Three Duck Lakes	5263621	432867	0	0	0	0	0	0	0	0	
Delaney Lake	5261878	431442	0	0	0	0	0	0	0	0	
Dividing Lake	5260542	435933	0	0	1	0	0	1	0	0	
Mesomikenda Lake Watershed											
Little Clam Lake	5267779	428484	0	0	0	0	0	0	0	0	
Schist Lake	5269771	428496	0	0	0	0	0	0	0	0	
Bagsverd Lake	5270639	431343	0	0	0	0	0	0	0	0	
Unnamed Lake #2	5273456	428297	0	0	0	0	0	0	0	0	
Unnamed Lake #1	5273426	428247	0	0	0	0	0	0	0	0	
Schou Lake	5273828	423987	0	0	2	0	0	0	0	0	
Wolf Lake	5278208	426646	0	0	2	0	0	0	0	0	
Somme Lake	5280152	429894	0	0	0	0	0	0	0	0	
Neville Lake	5278422	431497	0	0	0	0	0	0	0	0	Effluent discharge from the polishing pond during operations
Mesomikenda Lake	5283774	435026	5	0	41	0	0	0	0	0	

**PREDICTED AVERAGE TOTAL PHOSPHORUS CONCENTRATIONS IN
NEVILLE LAKE AND MESOMIKENDA LAKE
CÔTÉ GOLD PROJECT**

	Neville Lake	Mesomikenda Lake
Lakeshore Capacity Model Results - Predicted Total Phosphorus Concentrations (mg/L)		
Lake outflow total phosphorus (TP out)	0.0131	0.0105
Ice-free total phosphorus (TP lake)	0.0137	0.0110
Spring overturn total phosphorus (TP so)	0.0144	0.0117
Future total phosphorus (TP future)	0.0203	0.0129
Background total phosphorus (TP bk)	0.0137	0.0109
Total phosphorus threshold (TP bk+40%)	0.0192	0.0153
Total phosphorus threshold (TP bk+50%)	0.0205	0.0164
Total phosphorus threshold (TP bk+60%)	0.0219	0.0174
GoldSim Model Results - Predicted Total Phosphorus Concentrations (mg/L)		
Average Climatic Condition	0.0211	0.0145

TABLE 14a
PREDICTED PHOSPHOROUS CONCENTRATIONS IN LAKES DOWNSTREAM OF THE
CAMP SITE SEPTIC SYSTEM
CÔTÉ GOLD PROJECT

Description of Phosphorous Concentration	Bagsverd Lake (South)	Three Duck Lakes (Lower)
Provincial Water Quality Objectives		
PWQO ⁽¹⁾ (mg/L)	0.020	0.020
Predicted Average Total Phosphorous Concentrations ⁽²⁾		
Average Year Flow Conditions	0.015	0.016
Dry Year Flow Conditions	0.019	0.019
Wet Year Flow Conditions	0.014	0.017

Notes:

(1) Provincial Water Quality Objectives, Ministry of Environment and Energy (1994, Revised 1999).

(2) The predicted total phosphorous concentrations that account for solubility controls in the lake was completed using the equilibrium geochemical speciation/mass transfer model PHREEQC and geochemically creditable phases that are known to control phosphorous concentrations in the environment.

TABLE 15a
PREDICTED NITRATE, NITRITE AND AMMONIA CONCENTRATIONS IN LAKES DOWNSTREAM OF THE CAMP SITE SEPTIC SYSTEM
CÔTÉ GOLD PROJECT

Description of Concentration	Bagsverd Lake (South)				Three Duck Lakes (Lower)			
	Nitrate	Nitrite	Ammonia	Un-ionized Ammonia	Nitrate	Nitrite	Ammonia	Un-ionized Ammonia
Water Quality Guidelines								
PWQO ⁽²⁾ (mg/L)	N/A ⁽¹⁾	N/A ⁽¹⁾	N/A ⁽¹⁾	0.02	N/A ⁽¹⁾	N/A ⁽¹⁾	N/A ⁽¹⁾	0.02
CWQG ⁽³⁾ (mg/L)	13	0.06	6.89	0.019	13	0.06	6.89	0.019
Predicted Average Concentrations								
Average Year Flow Conditions (mg/L)	0.22	0.03	0.069	0.00020	0.21	0.027	0.073	0.00020
Dry Year Flow Conditions (mg/L)	0.25	0.029	0.074	0.00021	0.23	0.027	0.077	0.00022
Wet Year Flow Conditions (mg/L)	0.22	0.028	0.069	0.00020	0.22	0.027	0.075	0.00021

Notes:

(1) N/A = not applicable, no PWQO for nitrate, nitrite, or total ammonia.

(2) Provincial Water Quality Objectives, Ministry of Environment and Energy (1994, Revised 1999).

(3) CWQG - Canadian Water Quality Guidelines for the protection of aquatic life. Canadian Environmental Quality Guidelines, Canadian Council of Ministers of the Environment, September 2013 (CCME 2012).

TABLE 16a
COMPARISON OF PREDICTED NEVILLE LAKE WATER QUALITY WITH AND WITHOUT TOTAL SUSPENDED SOLIDS INPUT FROM THE POLISHING POND
CÔTÉ GOLD PROJECT

Parameter	Median Elemental Composition of Mine Rock Samples (n=236) ⁽¹⁾	Median Elemental Composition of Mine Rock Samples (n=236) (%)	Concentration in Total Suspended Solids Discharged from Polishing Pond ⁽²⁾ (mg/L)	Concentration in Total Dissolved Solids Discharged from Polishing Pond ⁽³⁾ (mg/L)	Predicted Monthly Average Neville Lake Concentration, Average Climatic Conditions (mg/L)			
					Without Total Suspended Solids Input ⁽⁴⁾		With Total Suspended Solids Input ⁽⁵⁾	
					Min	Max	Min	Max
Aluminum	16000	1.60	0.240	0.0986	0.0472	0.0555	0.0472	0.0859
Antimony	0.8	0.0000800	0.0000120	0.00828	0.000256	0.00111	0.000256	0.00111
Arsenic	1.5	0.000150	0.0000225	0.0233	0.00153	0.00389	0.00153	0.00389
Barium	21	0.00210	0.000315	0.0338	0.00585	0.00898	0.00585	0.00902
Beryllium	0.26	0.0000260	0.00000390	0.000562	0.000509	0.000540	0.000509	0.000541
Cadmium	0.03	0.00000300	0.000000450	0.0000627	0.0000203	0.0000257	0.0000203	0.0000257
Calcium	14500	1.45	0.218	154	7.44	23.1	7.44	23.2
Chromium	58	0.00580	0.000870	0.00844	0.00153	0.00232	0.00153	0.00243
Cobalt	5.7	0.000570	0.0000855	0.00117	0.000274	0.000382	0.000274	0.000393
Copper	42	0.00420	0.000630	0.0115	0.00111	0.00230	0.00111	0.00238
Iron	20000	2.00	0.300	0.117	0.173	0.184	0.174	0.22
Lead	1.7	0.00017	0.0000255	0.000470	0.0000523	0.0000983	0.0000523	0.000102
Magnesium	6950	0.695	0.104	4.27	1.36	1.72	1.36	1.73
Manganese	220	0.0220	0.00330	0.225	0.0588	0.0785	0.0588	0.0790
Mercury	0.05	0.00000500	0.000000750	0.000164	0.000000968	0.0000182	0.000000968	0.0000183
Molybdenum	0.7	0.0000700	0.0000105	0.0170	0.00104	0.00269	0.00104	0.00269
Nickel	9.3	0.000930	0.000140	0.00295	0.00153	0.00175	0.00153	0.00177
Potassium	1040	0.104	0.0156	9.79	0.366	1.38	0.366	1.38
Selenium	0.2	0.0000200	0.00000300	0.0158	0.0000521	0.00171	0.0000521	0.00171
Sodium	370	0.0370	0.00555	3.70	1.25	2.12	1.25	2.12
Strontium	16	0.00160	0.000240	0.249	0.0173	0.0425	0.0173	0.0425
Thallium	0.02	0.00000200	0.000000300	0.000384	0.000154	0.000185	0.000154	0.000185
Titanium	800	0.0800	0.0120	0.00209	0.00115	0.00133	0.00115	0.00286
Uranium	0.78	0.0000780	0.0000117	0.0193	0.00102	0.00297	0.00102	0.00297
Vanadium	20	0.00200	0.000300	0.00862	0.00102	0.00186	0.00102	0.00190
Zinc	22	0.00220	0.000330	0.0382	0.00887	0.0123	0.00887	0.0123

Notes:

Minimum (Min) and maximum (Max) monthly average concentrations are in mg/L. The minimum and maximum monthly average concentrations are taken from the results of the average climatic condition.

(1) Appendix E, Geochemical Characterization, Table 7-9.

(2) For the purposes of this analysis, the discharge of TSS was assumed to be conservatively high by using the Metal Mining Effluent Regulations [MMER] and O.Reg. 560/94 maximum permissible effluent TSS concentration of 15 mg/L as the TSS input concentration.

(3) The annual average parameter concentration in the polishing pond discharge under the average climatic condition.

(4) Without Total Suspended Solids Input - In the original model approach, total suspended solids concentrations were not predicted, but were qualitatively assessed based on rock geochemistry and process water quality at comparable gold operations.

(5) With Total Suspended Solids Input - In the revised model approach, the concentrations of various parameters comprising the total suspended solids was estimated using the median elemental composition of all mine rock samples (n=236) as presented in Appendix E – Geochemical Characterization Report, Table 7-9, assuming a maximum total suspended solids concentration of 15 mg/L (as the treated effluent from the polishing pond will be discharged in accordance with

TABLE 17a
COMPARISON OF ORIGINAL AND REVISED WATER QUALITY MODELING INPUT
LOADING RATES AFTER ADDING TAILINGS GEOCHEMISTRY DATA
CÔTÉ GOLD PROJECT

Parameter	Original Model Input Loading Rates ⁽¹⁾ (mg/kg/week)	Revised Model Input Loading Rates ⁽²⁾ (mg/kg/week)
Aluminum	0.057	0.067
Antimony	0.00025	0.00082
Arsenic	0.00073	0.00065
Barium	0.00089	0.0047
Boron	0.00058	0.0036
Cadmium	0.0000015	0.0000042
Calcium	4.7	81
Cobalt	0.000034	0.00032
Copper	0.00035	0.0015
Iron	0.0015	0.020
Lead	0.000012	0.000044
Magnesium	0.098	1.8
Manganese	0.0061	0.021
Molybdenum	0.00030	0.0059
Nickel	0.000067	0.0010
Potassium	0.31	3.2
Sodium	0.084	23
Strontium	0.0077	0.081
Sulphate	0.36	109
Uranium	0.00058	0.0012
Vanadium	0.00026	0.000088
Zinc	0.0010	0.0030

Notes:

(1) Original model input loading rates based on lithology-weighted loading rates calculated from humidity cell testing (weeks 20 to 34) of mine rock samples. Geochemical source terms were provided by AMEC.

(2) Revised model input loading rates based on the average loading rates calculated from humidity cell testing (weeks 0 to 18) of three composite tailings samples. Geochemical source terms were provided by AMEC.

TABLE 18a
COMPARISON OF ORIGINAL AND REVISED WATER QUALITY MODELING INPUT
PROCESS WATER QUALITY
CÔTÉ GOLD PROJECT

Parameter	Original Model Process Water Quality ⁽¹⁾ (mg/L)	Revised Model Process Water Quality ⁽²⁾ (mg/L)
Aluminum	0.050	1.5
Ammonia (Total)	20	20
Ammonia (Un-ionized) ⁽³⁾	N/A	N/A
Antimony	0.0010	0.0034
Arsenic	0.0010	0.0016
Barium	0.050	0.026
Boron	0.00001	0.015
Cadmium	0.000001	0.0000015
Calcium	50	104
Chloride	25	24
Cobalt	0.0010	0.0088
Copper	0.10	0.24
Cyanide (Total)	2.0	1.5
Cyanide (Free) ⁽⁴⁾	0.50	0.38
Iron	0.50	2.1
Lead	0.00010	0.00064
Magnesium	25	5.3
Manganese	0.05	0.044
Molybdenum	0.050	0.075
Nickel	0.010	0.0036
Nitrate	0	0.30
Potassium	25	44
Sodium	100	986
Strontium	0.10	0.19
Sulphate	250	2133
Uranium	0.0050	0.0054
Vanadium	0.00010	0.0020
Zinc	0.0020	0.0093

Notes:

(1) Original model input process water quality derived using knowledge of analogue gold mining project sites and professional judgment, with the exception of cyanide concentrations that were assumed based on the concept-level cyanide destruction treatment specifications.

(2) Revised model input process water quality based on bench-scale metallurgical testing and laboratory analysis of process water quality through an ageing test procedure on Day 0, Day 7, Day 29 and Day 60, with the average concentration from the Day 0 test data applied as the model input.

(3) N/A - not applicable. Un-ionized ammonia is calculated within the model using field pH and field temperature.

(4) Free cyanide concentration estimated from total cyanide concentration using the geochemical speciation model PHREEQC.

**TABLE 19a
COMPARISON OF ORIGINAL AND REVISED WATER QUALITY MODELING RESULTS AFTER ADDING TAILINGS GEOCHEMISTRY AND PROCESS WATER QUALITY DATA
CÔTÉ GOLD PROJECT**

Parameter	MESOMIKENDA LAKE WATERSHED																			
	Bagsverd Lake				Unnamed Lake #1				Bagsverd Creek				Neville Lake (Lower, Mixing Zone)				Mesomikenda Lake (Upper)			
	Original Model Predictions ⁽¹⁾		Revised Model Predictions ⁽²⁾		Original Model Predictions ⁽¹⁾		Revised Model Predictions ⁽²⁾		Original Model Predictions ⁽¹⁾		Revised Model Predictions ⁽²⁾		Original Model Predictions ⁽¹⁾		Revised Model Predictions ⁽²⁾		Original Model Predictions ⁽¹⁾		Revised Model Predictions ⁽²⁾	
	Min	Max	Min	Max	Min	Max	Min	Max	Min	Max	Min	Max	Min	Max	Min	Max	Min	Max	Min	Max
Aluminum	0.049	0.059	0.051	0.064	0.049	0.096	0.051	0.11	0.022	0.071	0.027	0.082	0.047	0.054	0.047	0.055	0.045	0.047	0.045	0.047
Ammonia (Total)	0.077	0.13	0.077	0.13	0.082	0.37	0.082	0.37	0.075	0.23	0.075	0.23	0.057	0.35	0.057	0.35	0.060	0.076	0.060	0.076
Ammonia (Un-ionized)	0.000069	0.00072	0.000069	0.00072	0.000092	0.0022	0.000092	0.0022	0.000086	0.0012	0.000086	0.0012	0.000041	0.0018	0.000041	0.0018	0.000042	0.00045	0.000042	0.00045
Antimony	0.00027	0.00033	0.00027	0.00033	0.00027	0.00053	0.00027	0.00056	0.00012	0.00039	0.00013	0.00041	0.00025	0.0012	0.00026	0.0012	0.00028	0.00035	0.00028	0.00035
Arsenic	0.0016	0.0019	0.0016	0.0019	0.0016	0.0031	0.0016	0.0031	0.00073	0.0023	0.00073	0.0023	0.0015	0.0040	0.0015	0.0041	0.0016	0.0018	0.0016	0.0018
Barium	0.0062	0.0076	0.0062	0.0075	0.0062	0.013	0.0062	0.012	0.0029	0.0092	0.0029	0.0090	0.0059	0.0091	0.0059	0.0091	0.0058	0.0061	0.0057	0.0061
Boron	0.0054	0.0065	0.0054	0.0065	0.0053	0.010	0.0054	0.011	0.0024	0.0077	0.0025	0.0078	0.0051	0.0070	0.0051	0.0070	0.0050	0.0052	0.0050	0.0052
Cadmium	0.000022	0.000026	0.000022	0.000026	0.000021	0.000041	0.000021	0.000041	0.000010	0.000031	0.000010	0.000031	0.000020	0.000026	0.000020	0.000026	0.000020	0.000021	0.000020	0.000021
Calcium	7.9	9.6	7.9	9.7	7.9	16	7.9	16	3.7	12	3.8	12	7.4	24	7.4	24	7.7	9.1	7.7	9.1
Chloride	0.79	0.99	0.79	0.99	0.79	1.8	0.79	1.8	0.42	1.3	0.42	1.3	0.73	1.4	0.73	1.4	0.72	0.79	0.72	0.79
Cobalt	0.00029	0.00035	0.00030	0.00037	0.00029	0.00056	0.00030	0.00067	0.00013	0.00042	0.00016	0.00048	0.00027	0.00038	0.00027	0.00038	0.00026	0.00028	0.00027	0.00028
Copper	0.0012	0.0016	0.0013	0.0019	0.0012	0.0031	0.0014	0.0045	0.00073	0.0022	0.0010	0.0030	0.0011	0.0023	0.0011	0.0024	0.0011	0.0012	0.0011	0.0012
Cyanide (Total)	0.0039	0.0083	0.0028	0.0052	0.0045	0.029	0.0031	0.017	0.0039	0.018	0.0028	0.010	0.0015	0.0035	0.0013	0.0025	0.0016	0.0017	0.0015	0.0015
Cyanide (Free)	0.0010	0.0021	0.00070	0.0013	0.0011	0.0073	0.00077	0.0042	0.0010	0.0044	0.00069	0.0026	0.00045	0.00092	0.00040	0.00067	0.00043	0.00045	0.00039	0.00041
Iron	0.18	0.22	0.19	0.23	0.18	0.36	0.18	0.38	0.084	0.26	0.089	0.28	0.17	0.19	0.17	0.19	0.16	0.17	0.16	0.17
Magnesium	1.5	1.8	1.4	1.7	1.5	3.1	1.4	2.8	0.72	2.2	0.66	2.1	1.4	1.7	1.4	1.7	1.3	1.4	1.3	1.4
Manganese	0.062	0.075	0.062	0.075	0.062	0.12	0.062	0.12	0.028	0.089	0.028	0.089	0.059	0.079	0.059	0.079	0.057	0.060	0.057	0.060
Molybdenum	0.0011	0.0014	0.0012	0.0015	0.0011	0.0027	0.0012	0.0031	0.00064	0.0019	0.00072	0.0021	0.0010	0.0028	0.0010	0.0028	0.0010	0.0012	0.0010	0.0012
Lead	0.000055	0.000067	0.000056	0.000068	0.000055	0.00011	0.000056	0.00011	0.000025	0.000079	0.000027	0.000083	0.000052	0.00010	0.000052	0.00010	0.000052	0.000056	0.000052	0.000056
Nickel	0.0016	0.0020	0.0016	0.0020	0.0016	0.0032	0.0016	0.0032	0.00076	0.0024	0.00074	0.0023	0.0015	0.0018	0.0015	0.0018	0.0015	0.0015	0.0015	0.0015
Nitrate	0.066	0.079	0.066	0.080	0.066	0.13	0.066	0.13	0.030	0.094	0.031	0.096	0.062	1.1	0.062	1.07	0.090	0.14	0.090	0.14
Potassium	0.40	0.52	0.42	0.58	0.40	1.0	0.43	1.3	0.24	0.72	0.30	0.87	0.36	1.4	0.37	1.5	0.38	0.47	0.38	0.47
Sodium	1.2	1.6	2.2	4.4	1.2	3.4	2.5	15	0.79	2.3	2.2	9.1	1.0	1.4	1.2	2.2	1.0	1.0	1.1	1.2
Strontium	0.018	0.022	0.018	0.023	0.018	0.036	0.018	0.038	0.0085	0.027	0.0088	0.028	0.017	0.044	0.017	0.044	0.018	0.020	0.018	0.020
Sulphate	3.5	4.7	5.8	10.6	3.6	9.5	6.3	34	2.2	6.5	5.7	21	3.1	4.6	3.6	6.1	3.0	3.2	3.3	3.5
Uranium	0.0011	0.0013	0.0011	0.0013	0.0011	0.0021	0.0011	0.0021	0.00050	0.0016	0.00050	0.0016	0.0010	0.0031	0.0010	0.0031	0.0011	0.0012	0.0011	0.0012
Vanadium	0.0011	0.0013	0.0011	0.0013	0.0011	0.0021	0.0011	0.0021	0.00049	0.0015	0.00049	0.0015	0.0010	0.0019	0.0010	0.0019	0.0010	0.0011	0.0010	0.0011
Zinc	0.0094	0.011	0.0094	0.011	0.0093	0.018	0.0093	0.018	0.0042	0.013	0.0043	0.013	0.0089	0.012	0.0089	0.012	0.0086	0.0091	0.0086	0.0091

Notes:
 Minimum (Min) and maximum (Max) monthly average concentrations are in mg/L. The minimum and maximum monthly average concentrations are taken from the results of the average, 1:25-year dry and 1:25-year wet conditions.
 (1) Original model inputs assumed the tailings geochemistry, including metal leaching characteristics, were similar to the mine rock; as such, the model input for the tailings geochemistry was assigned based on MRA loading rates. Process water quality was derived using knowledge of analogue gold mining project sites and professional judgement; the exception was cyanide concentrations in the process water that were assumed based on the concept-level cyanide destruction treatment specifications.
 (2) Revised model inputs are based on the results of recent bench-scale metallurgical testing. The model input for the tailings geochemistry was assigned based on the results of humidity cell testing performed on three composite tailings samples produced for the Côté Gold Project. The model input process water quality was based on laboratory analysis of process water quality through an ageing test procedure on Day 0, Day 7, Day 29 and Day 60, with the average concentration from the Day 0 test data applied as the model input.

TABLE 20a
PREDICTED LOADS FROM SEEPAGE FROM TAILINGS MANAGEMENT FACILITY AND MINE
ROCK AREA UNDER AVERAGE CLIMATIC CONDITION
CÔTÉ GOLD PROJECT

Parameter	Total Seepage Load from Tailings Management Facility (kg/day)	Total Seepage Load from Mine Rock Area (kg/day)
Aluminum	0.14	28
Ammonia (total)	1.9	251
Antimony	0.00033	2.47
Arsenic	0.00015	7.3
Barium	0.0025	8.8
Boron	0.0014	5.8
Cadmium	0.00000014	0.015
Calcium	9.9	46965
Chloride	2.3	1986
Cobalt	0.00085	0.33
Copper	0.017	3.5
Cyanide (total)	0.14	N/A
Cyanide (free)	0.036	N/A
Iron	0.20	15
Lead	0.000061	0.11
Magnesium	0.51	969
Manganese	0.0042	61.0
Molybdenum	0.0072	3.0
Nickel	0.00035	0.68
Nitrate	0.029	862
Phosphorus (total)	0.00096	104
Potassium	4.2	3063
Sodium	94	830
Strontium	0.018	76
Sulphate	204	3596
Uranium	0.00052	5.8
Vanadium	0.00019	2.6
Zinc	0.00089	9.9

Notes:

N/A - not applicable.

TABLE 21a
REVISED MONTHLY AVERAGE FREE CYANIDE CONCENTRATIONS - MESOMIKENDA LAKE WATERSHED
CÔTÉ GOLD PROJECT

Climatic Condition	Month	Monthly Average Free Cyanide Concentration (mg/L)				
		Bagsverd Lake	Unnamed Lake	Bagsverd Creek	Neville Lake	Mesomikenda Lake
Average Condition	January	0.0011	0.0019	0.0019	0.00058	0.00040
	February	0.0012	0.0021	0.0021	0.00060	0.00040
	March	0.0012	0.0017	0.0016	0.00066	0.00039
	April	0.0012	0.0012	0.00094	0.00057	0.00039
	May	0.00089	0.00077	0.00069	0.00046	0.00039
	June	0.00070	0.00092	0.00091	0.00041	0.00039
	July	0.00078	0.0015	0.0015	0.00041	0.00040
	August	0.00087	0.0022	0.0022	0.00044	0.00039
	September	0.00095	0.0026	0.0026	0.00049	0.00039
	October	0.0010	0.0020	0.0019	0.00056	0.00039
	November	0.0011	0.0017	0.0015	0.00062	0.00040
	December	0.0011	0.0014	0.0014	0.00061	0.00039
1:25-Year Dry Condition	January	0.0012	0.0022	0.0022	0.00061	0.00040
	February	0.0012	0.0018	0.0017	0.00064	0.00040
	March	0.0012	0.0021	0.0020	0.00063	0.00040
	April	0.0011	0.00087	0.00073	0.00053	0.00040
	May	0.00090	0.0011	0.0011	0.00045	0.00040
	June	0.00095	0.0019	0.0016	0.00046	0.00040
	July	0.0011	0.0037	0.00099	0.00046	0.00040
	August	0.0012	0.0041	0.0021	0.00055	0.00041
	September	0.0013	0.0042	0.0023	0.00057	0.00041
	October	0.0013	0.0022	0.0019	0.00063	0.00040
	November	0.0013	0.0014	0.0011	0.00067	0.00040
	December	0.0013	0.0015	0.0014	0.00063	0.00040
1:25-Year Wet Condition	January	0.0012	0.0023	0.0023	0.00062	0.00040
	February	0.0012	0.0022	0.0021	0.00063	0.00041
	March	0.0013	0.0017	0.0015	0.00066	0.00041
	April	0.0012	0.0011	0.00086	0.00059	0.00041
	May	0.00082	0.00078	0.00073	0.00044	0.00040
	June	0.00072	0.00092	0.00091	0.00040	0.00040
	July	0.00078	0.0013	0.0013	0.00041	0.00040
	August	0.00086	0.0021	0.0021	0.00043	0.00040
	September	0.00095	0.0026	0.0024	0.00047	0.00040
	October	0.00098	0.0013	0.0011	0.00051	0.00040
	November	0.00092	0.00095	0.00086	0.00046	0.00040
	December	0.00089	0.0011	0.0010	0.00047	0.00040

Notes:

- Concentrations are less than the Provincial Water Quality Objective/Canadian Water Quality Guideline of 0.005 mg/L.
- Revised free cyanide predictions incorporate attenuation within the shallow tailings.

**COMPARISON OF ORIGINAL AND REVISED WATER QUALITY MODELING INPUT ARSENIC LOADING RATES
CÔTÉ GOLD PROJECT**

Original Model Input Loading Rates ⁽¹⁾				Revised Model Input Loading Rates ⁽²⁾					
Humidity Cell Sample ID	Lithology	Arsenic Loading Rate (mg/kg/week)	Arsenic Loading Rate Weighted by Lithology Tonnage ⁽³⁾ (mg/kg/week)	Humidity Cell Sample ID	Lithology	Arsenic Loading Rate (mg/kg/week)	Arsenic Loading Rate Weighted by Lithology Tonnage ⁽³⁾ (mg/kg/week)		
HC-1	Tonalite	0.00070		HC-1	Tonalite	0.00061			
HC-2	Tonalite	0.00060		HC-2	Tonalite	0.00045			
HC-3	Tonalite	0.00063		HC-3	Tonalite	0.0004			
HC-4	Tonalite	0.00036		HC-4	Tonalite	0.00029			
HC-6	Tonalite	0.00099		HC-6	Tonalite	0.00064			
HC-8	Tonalite	0.0016		HC-8	Tonalite	0.00087			
Tonalite Median		0.00066		0.000426	Tonalite median			0.00053	0.000341
HC-5	Magma Mixing Breccia	0.00040			HC-5	Magma Mixing Breccia		0.00032	
HC-7	Magma Mixing Breccia	0.00093	HC-7		Magma Mixing Breccia	0.00067			
Magma Mixing Breccia Median		0.00066	0.00000734		Magma Mixing Breccia Median		0.00050	0.00000550	
HC-9	Diorite	0.0055		HC-9	Diorite	0.0045			
HC-14	Diorite	0.0024		HC-14	Diorite	0.002			
HC-10	Diorite	0.00093		HC-10	Diorite	0.00093			
HC-13	Diorite	0.00056		HC-13	Diorite	0.00036			
Median "High" Diorite		0.0039		0.0000394	Median Diorite			0.0015	0.000293
Median "Low" Diorite		0.00075	0.000142						
HC-11	Diorite Breccia	0.0015		HC-11	Diorite Breccia	0.0011			
HC-12	Diorite Breccia	0.00043		HC-12	Diorite Breccia	0.00026			
Diorite Breccia Median		0.00094	0.0000743	Diorite Breccia Median		0.00068	0.0000535		
Median Other Lithologies		0.00066	0.0000446	Median Other Lithologies		0.00063	0.0000421		
TOTAL			0.000733	TOTAL			0.000735		

Notes:

- (1) Original model inputs based on humidity cell test loading rates (weeks 20-34) with "higher arsenic" and "lower arsenic" mine rock designations weighted by tonnage.
- (2) Revised model inputs based on updated humidity cell test loading rates (to week 75) and equitably applying diorite humidity cell loading rates to the total tonnage of diorite.
- (3) Arsenic loading rates were weighted by tonnage by multiplying the median loading rate by the proportion of each lithology's tonnage as compared to the total tonnage.

TABLE 23a
COMPARISON OF ORIGINAL AND REVISED WATER QUALITY
MODELING RESULTS AFTER REVISING ARSENIC INPUTS FROM
UPDATED HUMIDITY CELL TEST DATA -
MESOMIKENDA LAKE WATERSHED
CÔTÉ GOLD PROJECT

		Original Model Predictions ⁽¹⁾	Revised Model Predictions ⁽²⁾
Bagsverd Lake	Min	0.001614	0.001615
	Max	0.001942	0.001944
Unnamed Lake #1	Min	0.001606	0.001607
	Max	0.003118	0.003126
Bagsverd Creek	Min	0.000730	0.000732
	Max	0.002307	0.002312
Neville Lake (Lower, Mixing)	Min	0.001526	0.001527
	Max	0.004047	0.004053
Mesomikenda Lake	Min	0.001561	0.001561
	Max	0.001779	0.001780

Notes:

Minimum (Min) and maximum (Max) monthly average concentrations are in mg/L. The minimum and maximum monthly average concentrations are taken from the results of the average, 1:25-year dry and 1:25-year wet conditions.

(1) Original model inputs based on humidity cell test loading rates (weeks 20-34) with "higher arsenic" and "lower arsenic" mine rock designations weighted by tonnage.

(2) Revised model inputs based on updated humidity cell test loading rates (to week 75) and equitably applying diorite humidity cell loading rates to the total tonnage of diorite.

TABLE 24a
COMPARISON OF ORIGINAL AND REVISED WATER QUALITY MODELING
RESULTS AFTER REVISING ARSENIC INPUTS FROM UPDATED HUMIDITY
CELL TEST DATA -
MOLLIE RIVER WATERSHED
CÔTÉ GOLD PROJECT

		Original Model Predictions ⁽¹⁾	Revised Model Predictions ⁽²⁾
Chester Lake	Min	0.001696	0.001696
	Max	0.002341	0.002343
Clam Lake	Min	0.001720	0.001720
	Max	0.002193	0.002195
Little Clam Lake	Min	0.001769	0.001769
	Max	0.002233	0.002234
Bagsverd Lake (South)	Min	0.001811	0.001801
	Max	0.002267	0.002238
Weeduck Lake	Min	0.001809	0.001798
	Max	0.002083	0.002071
Three Duck Lakes (Upper/Middle)	Min	0.001482	0.001474
	Max	0.003279	0.003237
Three Duck Lakes (Lower)	Min	0.001945	0.001945
	Max	0.002298	0.002298
Delaney Lake	Min	0.001623	0.001624
	Max	0.004369	0.004372
Dividing Lake	Min	0.001953	0.001947
	Max	0.002163	0.002154

Notes:

Minimum (Min) and maximum (Max) monthly average concentrations are in mg/L. The minimum and maximum monthly average concentrations are taken from the results of the average, 1:25-year dry and 1:25-year wet conditions.

(1) Original model inputs based on humidity cell test loading rates (weeks 20-34) with "higher arsenic" and "lower arsenic" mine rock designations weighted by tonnage.

(2) Revised model inputs based on updated humidity cell test loading rates (to week 75) and equitably applying diorite humidity cell loading rates to the total tonnage of diorite.

UPDATED BASELINE SURFACE WATER QUALITY DATASET - AVERAGE PARAMETER CONCENTRATIONS, MOLLIE RIVER WATERSHED
CÔTÉ GOLD PROJECT

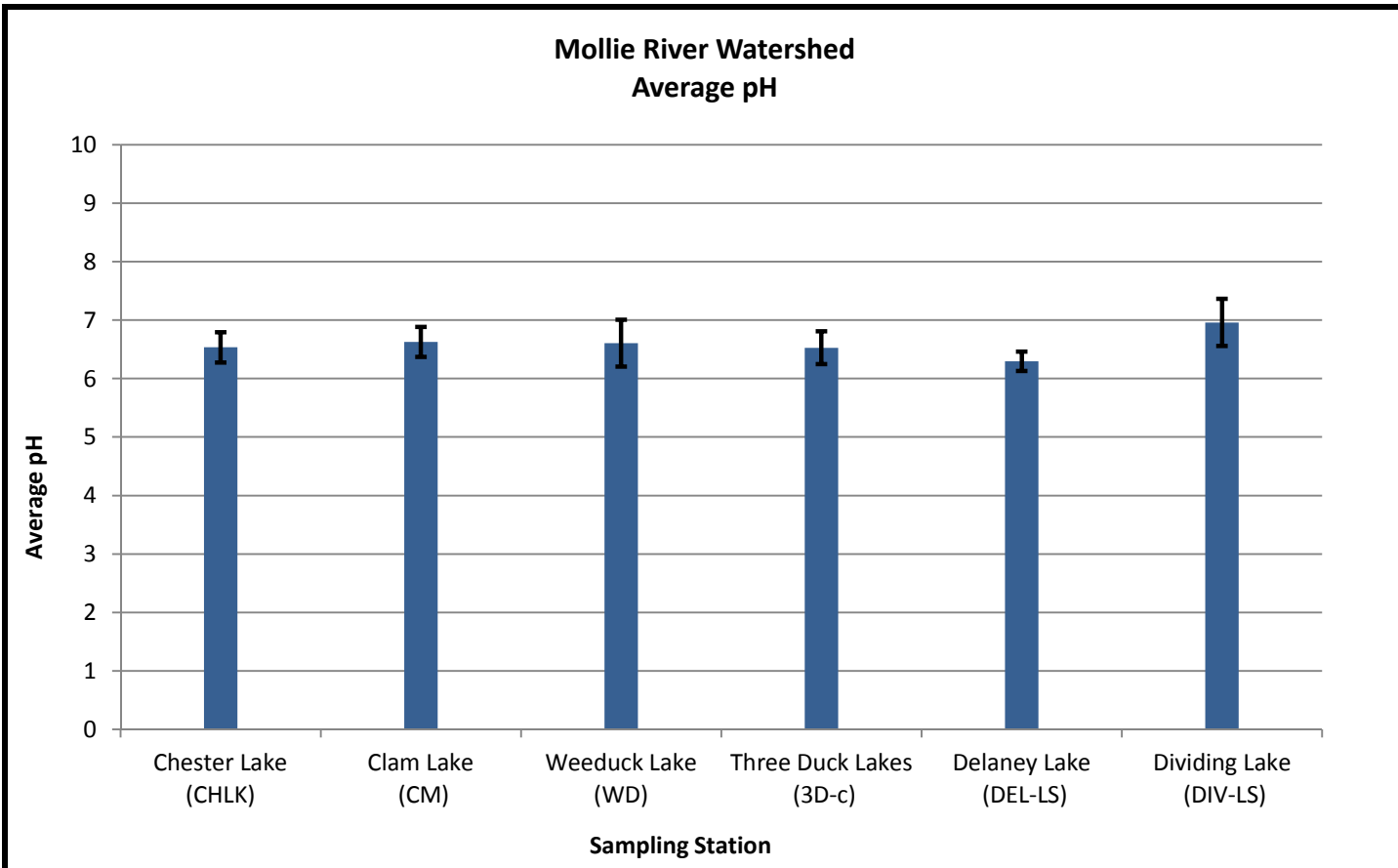

Note: For the purposes of statistical calculations, concentrations below the detection limit were assumed to be one-half the detection limit. Bars depict one standard deviation.

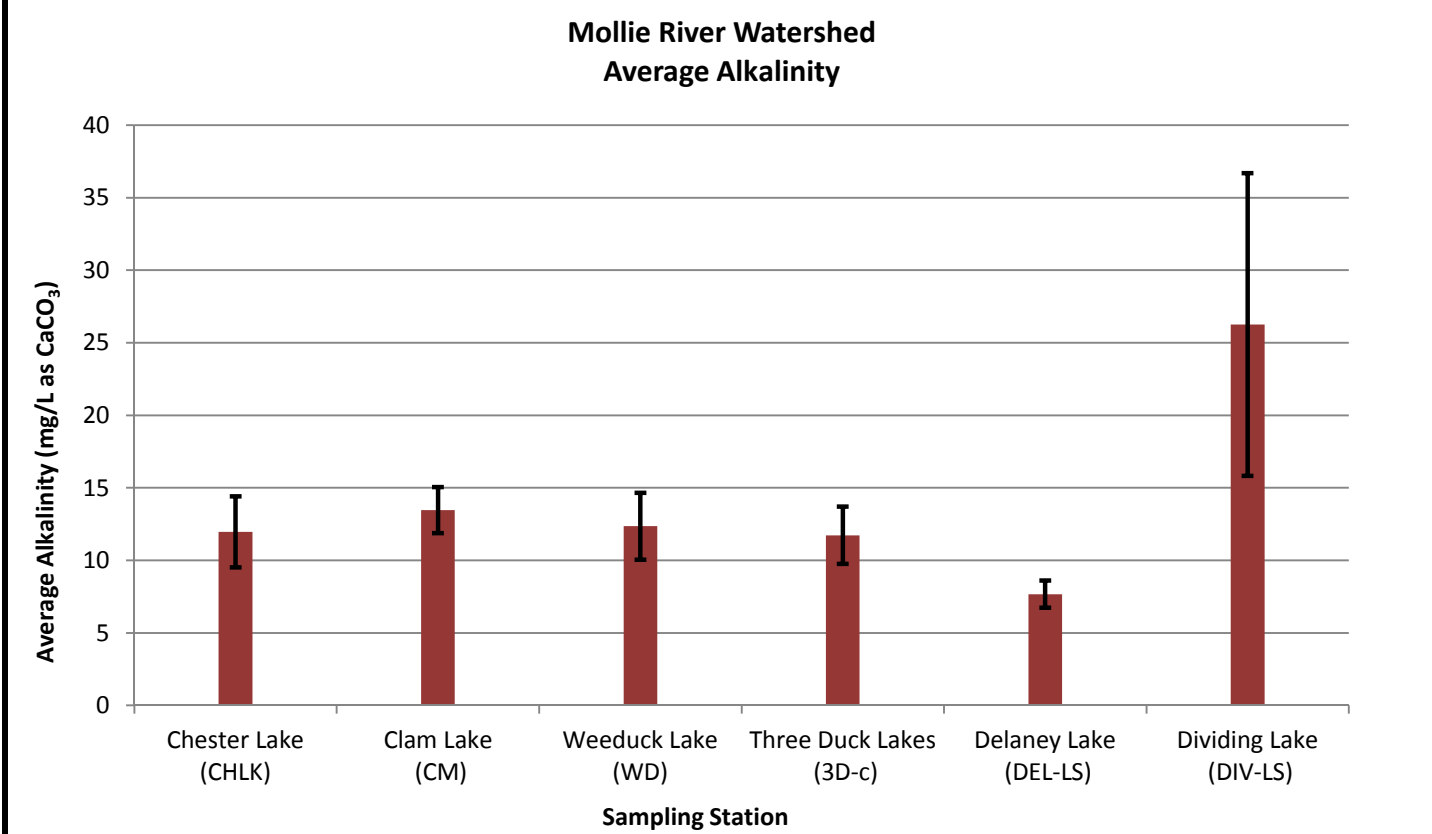

Note: For the purposes of statistical calculations, concentrations below the detection limit were assumed to be one-half the detection limit. Bars depict one standard deviation.

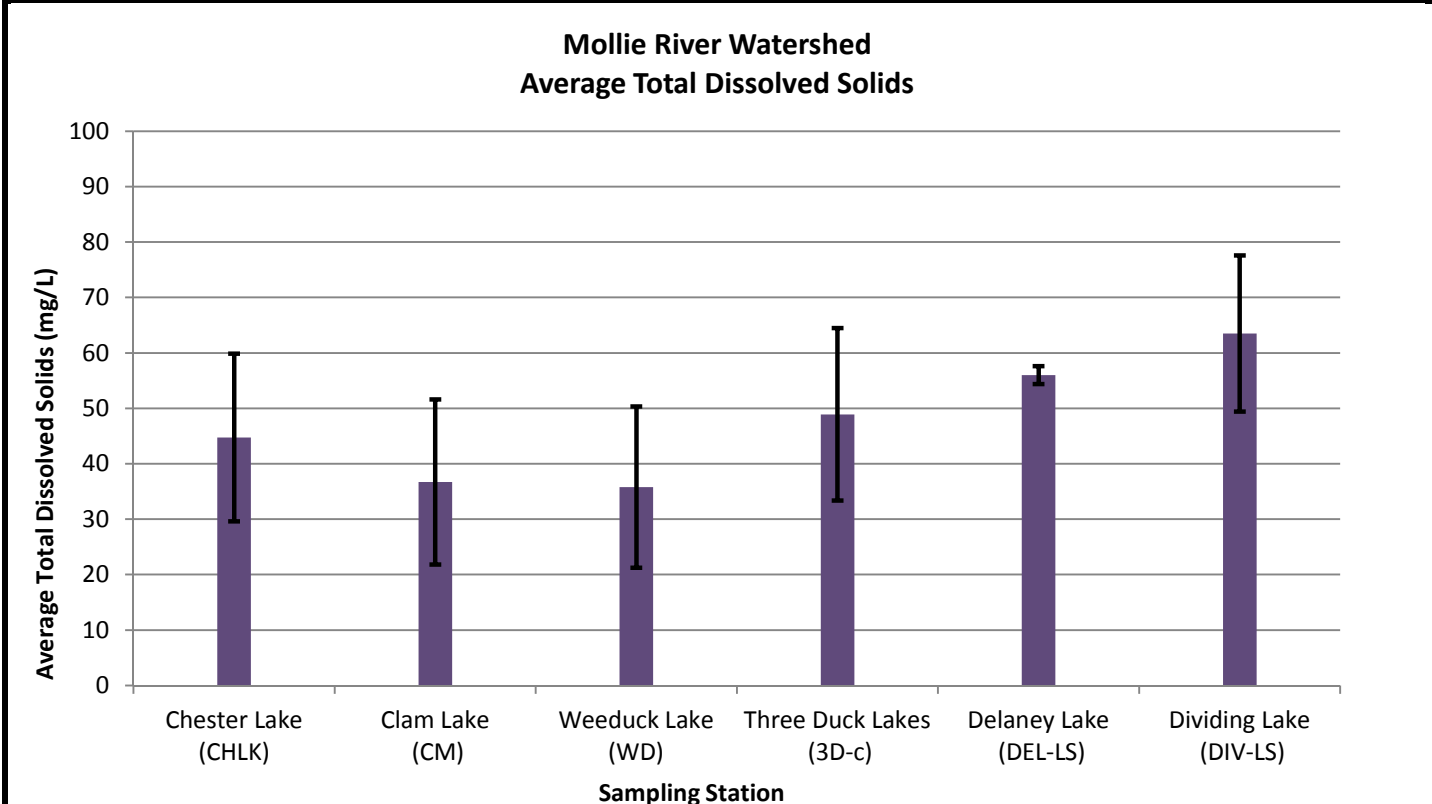

Note: For the purposes of statistical calculations, concentrations below the detection limit were assumed to be one-half the detection limit. Bars depict one standard deviation.

UPDATED BASELINE SURFACE WATER QUALITY DATASET - AVERAGE PARAMETER CONCENTRATIONS, MOLLIE RIVER WATERSHED
CÔTÉ GOLD PROJECT

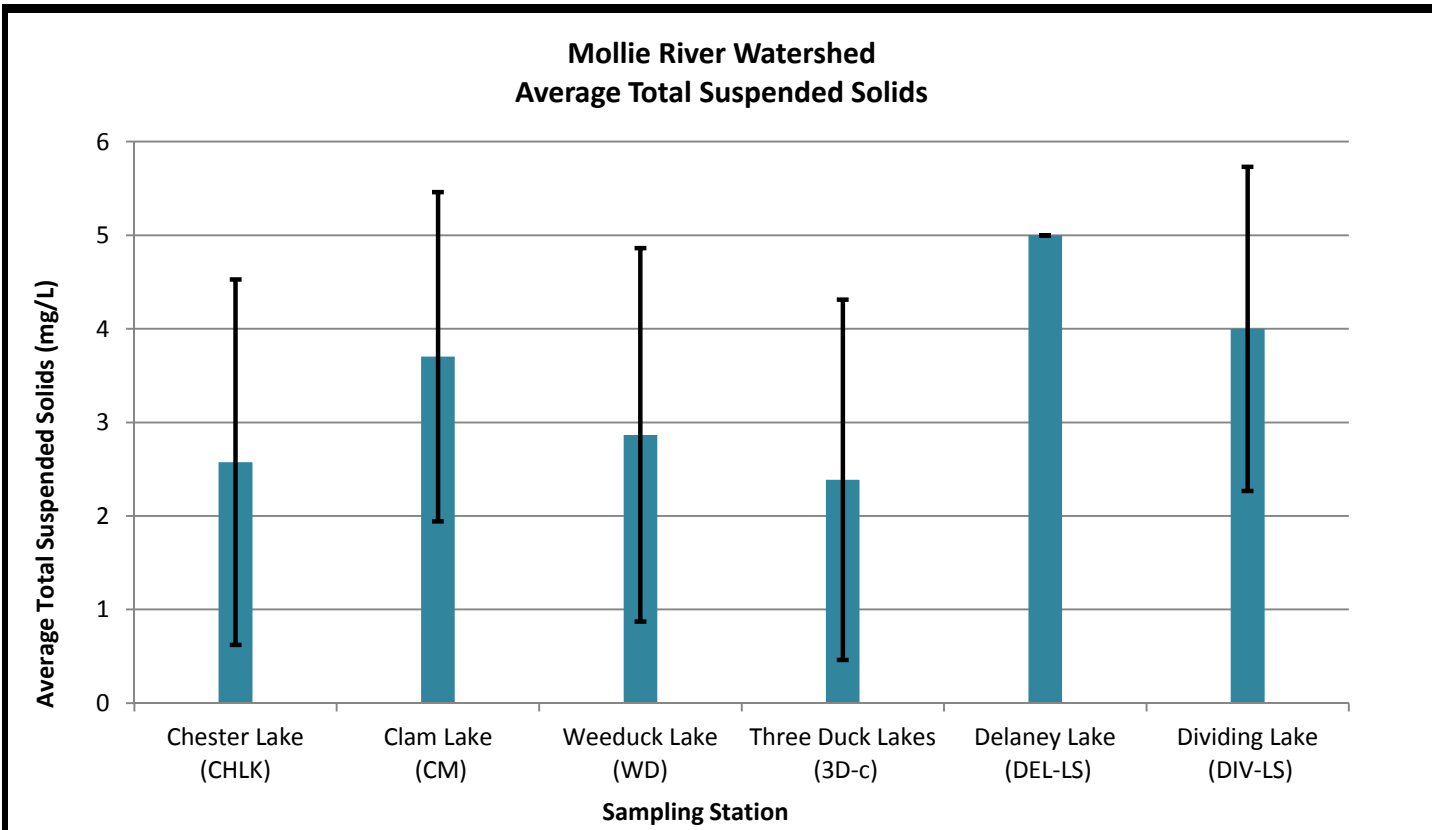

Note: For the purposes of statistical calculations, concentrations below the detection limit were assumed to be one-half the detection limit. Bars depict one standard deviation.

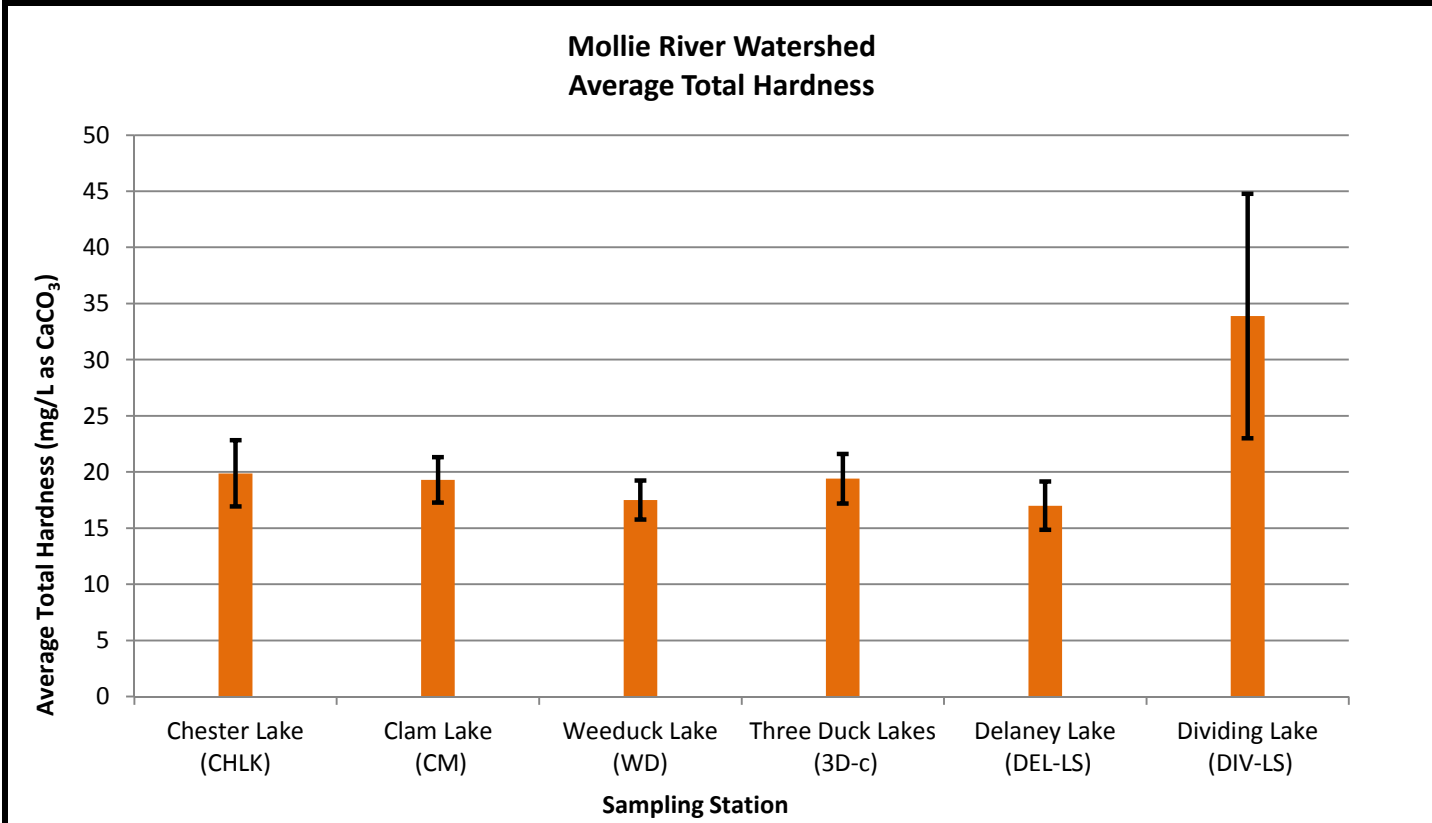

Note: For the purposes of statistical calculations, concentrations below the detection limit were assumed to be one-half the detection limit. Bars depict one standard deviation.

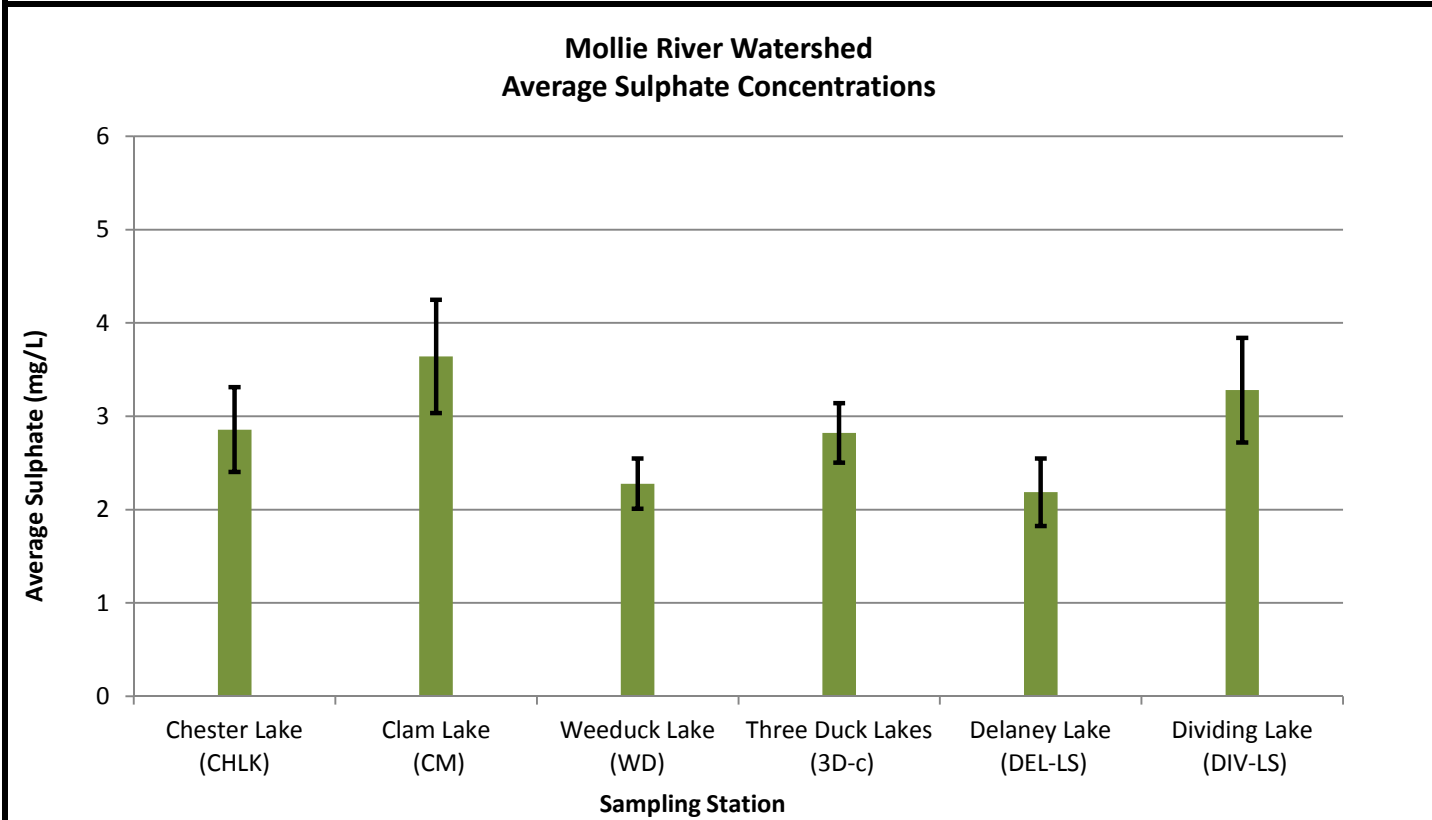

Note: For the purposes of statistical calculations, concentrations below the detection limit were assumed to be one-half the detection limit. Bars depict one standard deviation.

UPDATED BASELINE SURFACE WATER QUALITY DATASET - AVERAGE PARAMETER CONCENTRATIONS, MOLLIE RIVER WATERSHED
CÔTÉ GOLD PROJECT

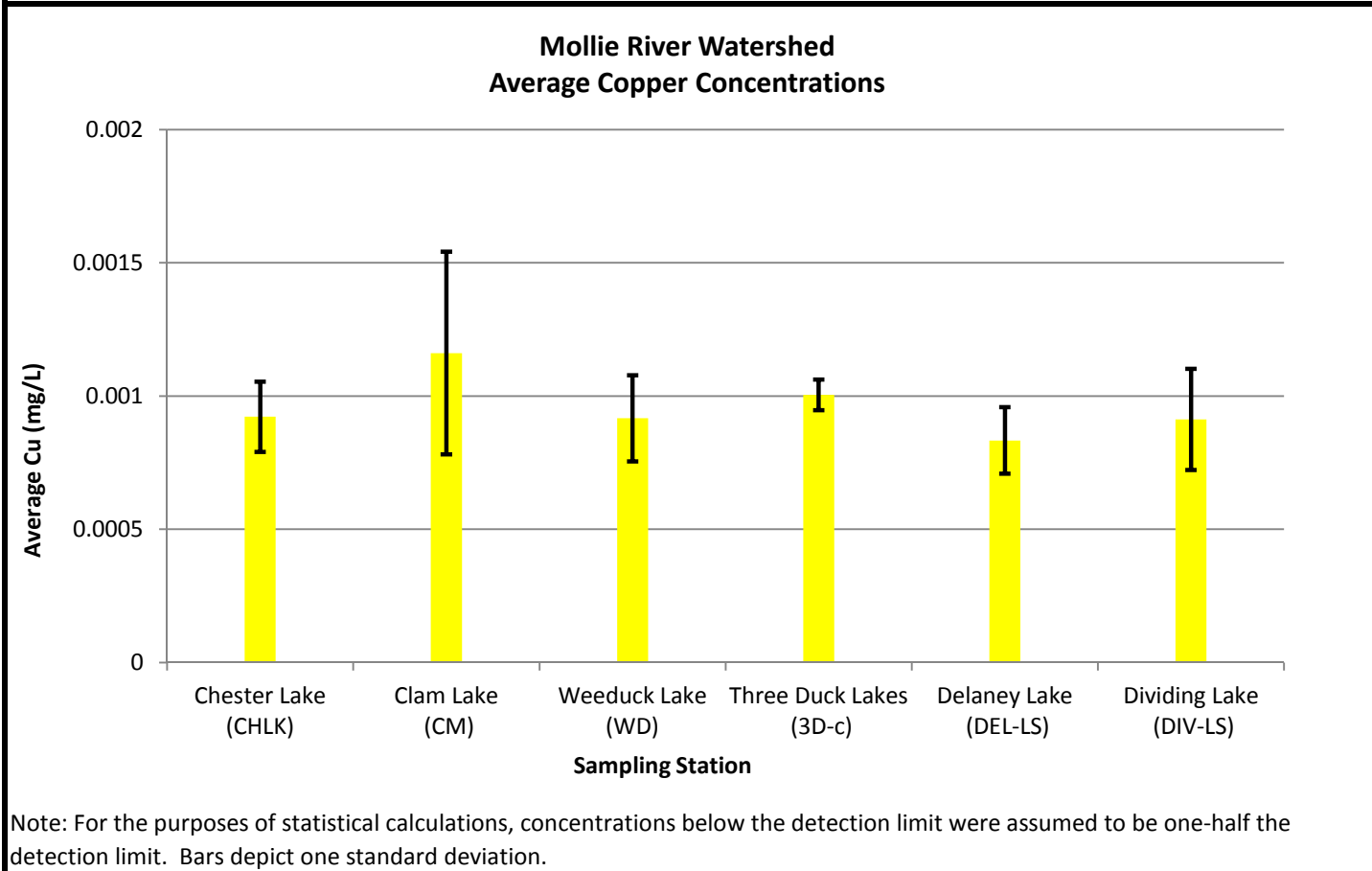
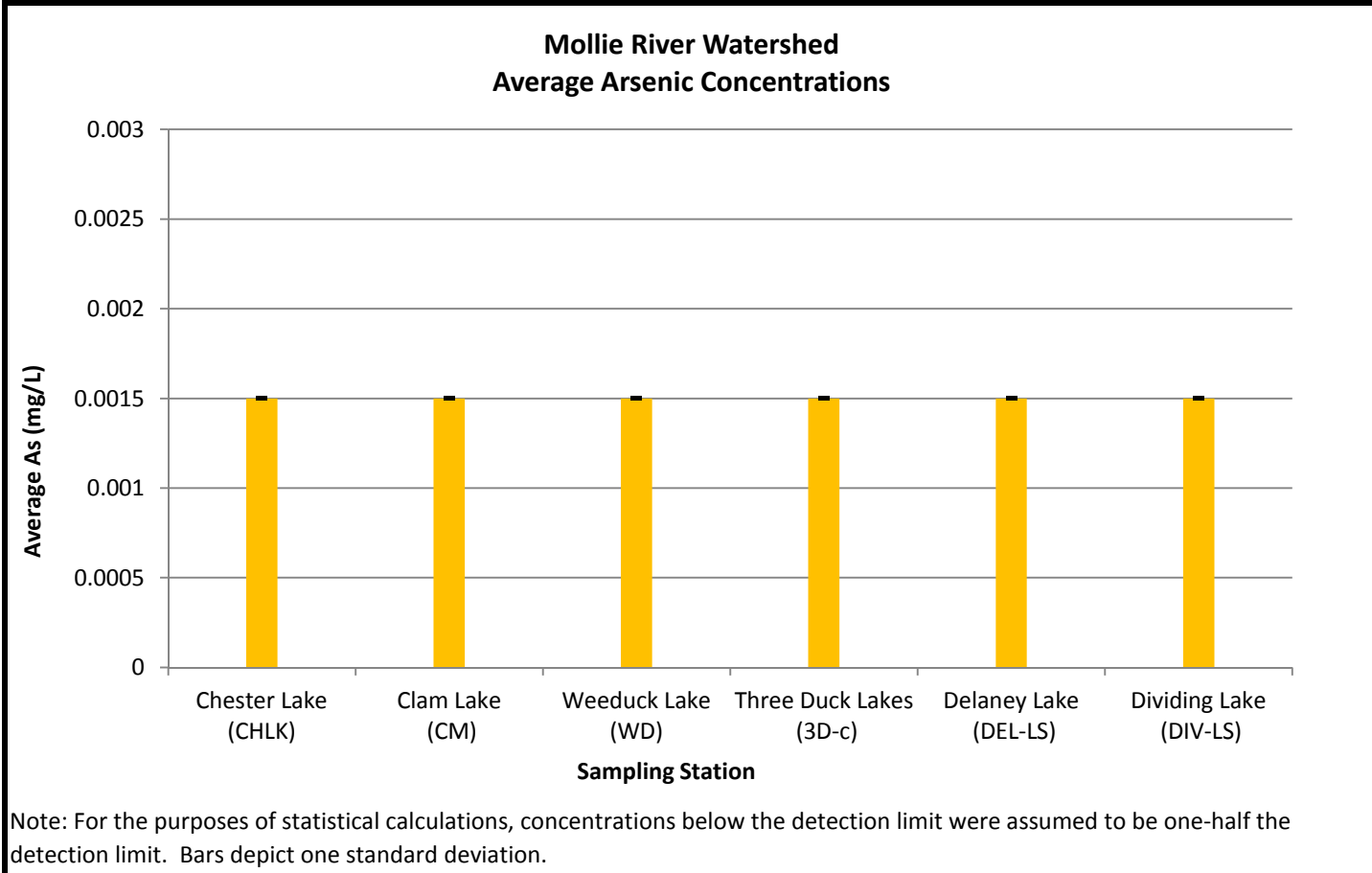
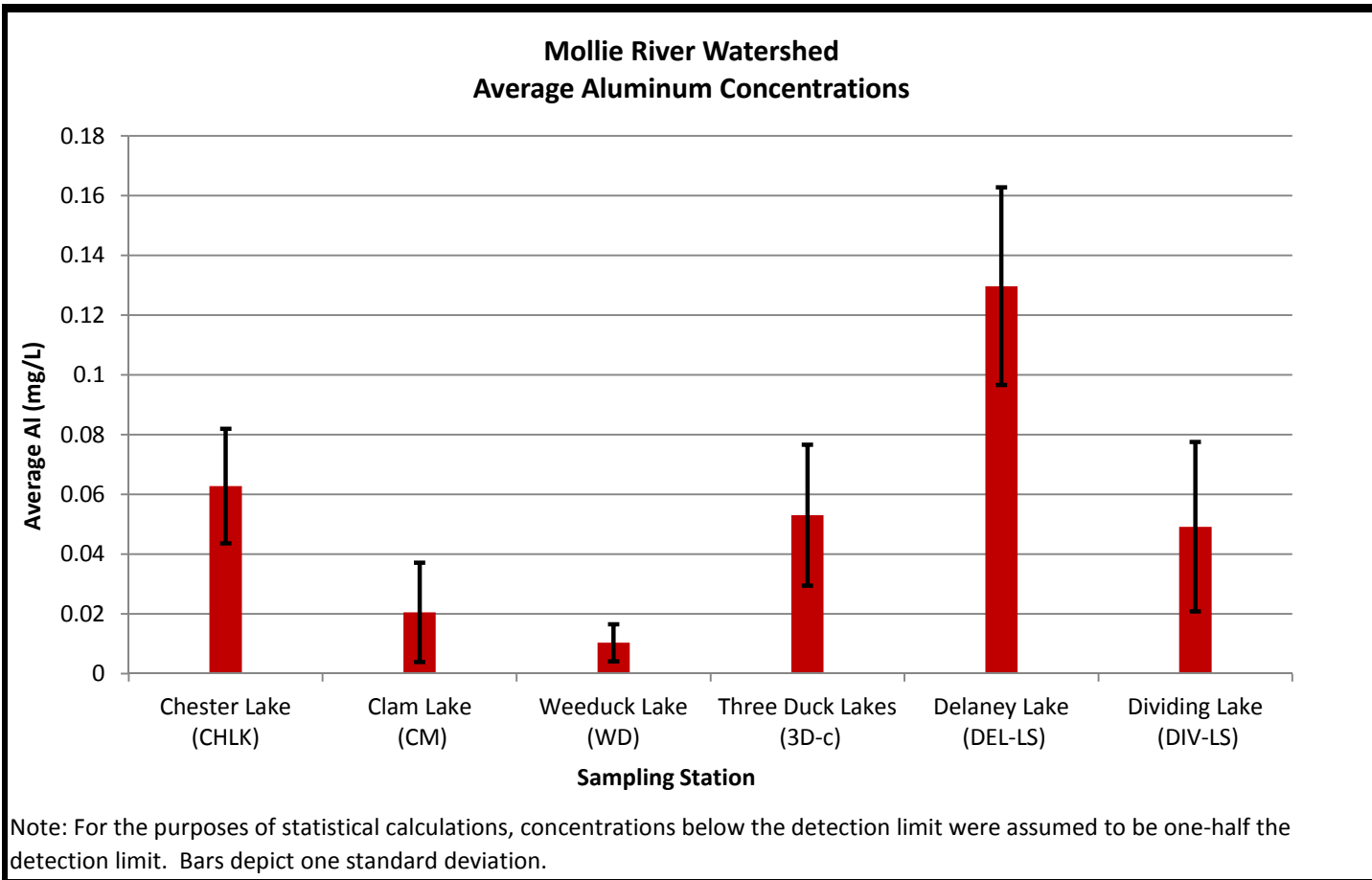

UPDATED BASELINE SURFACE WATER QUALITY DATASET - AVERAGE PARAMETER CONCENTRATIONS, MOLLIE RIVER WATERSHED
CÔTÉ GOLD PROJECT

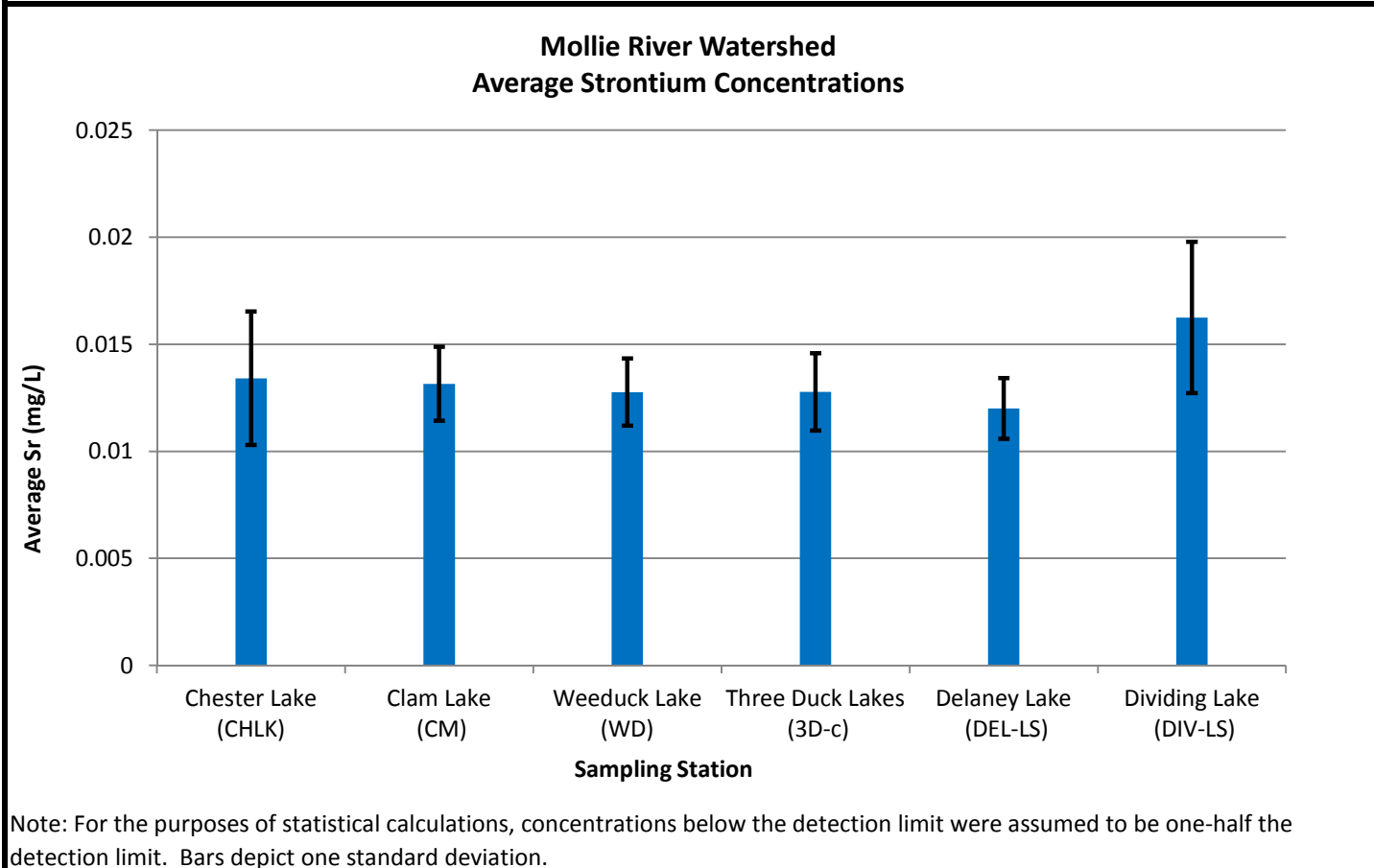
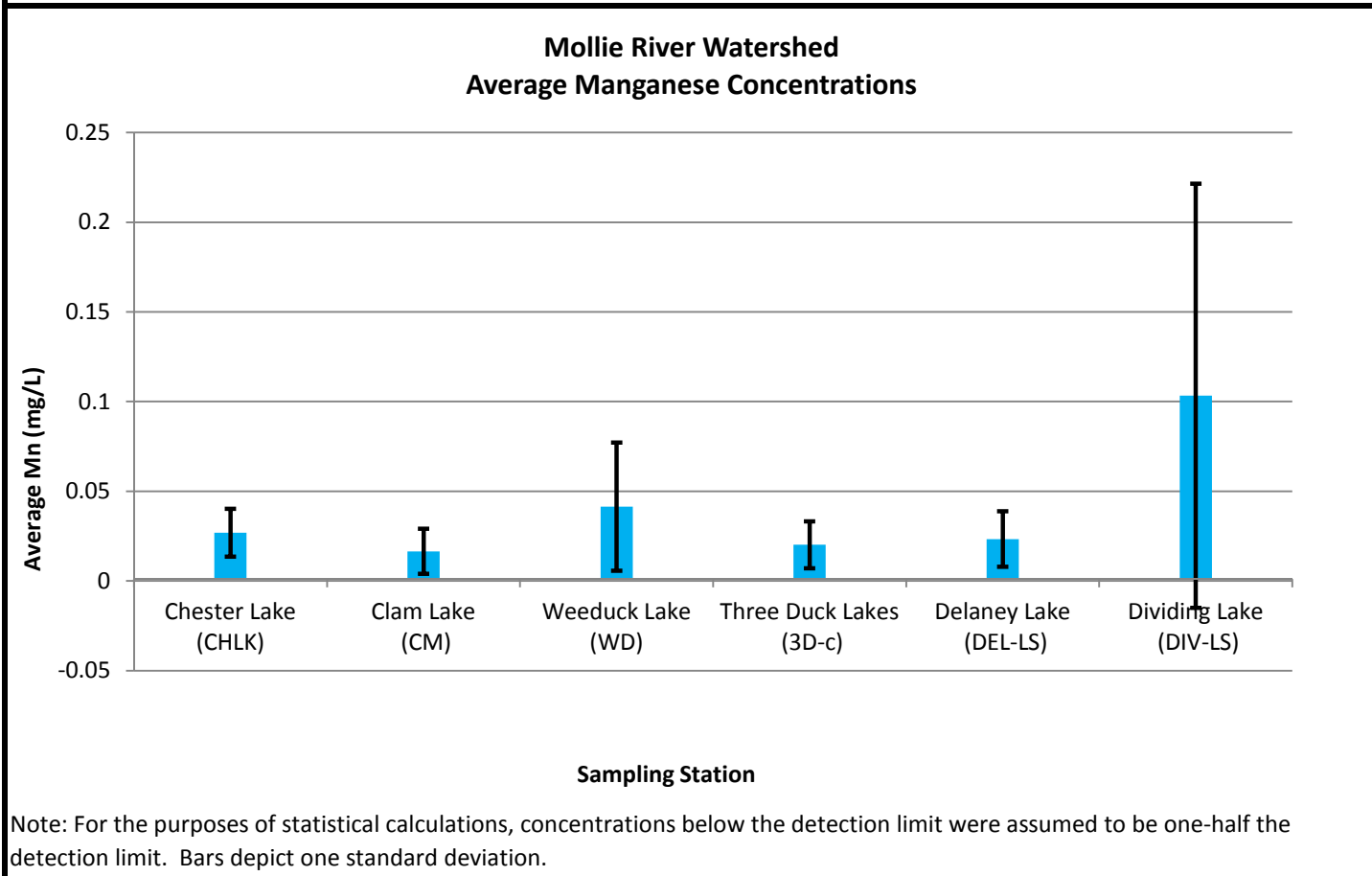
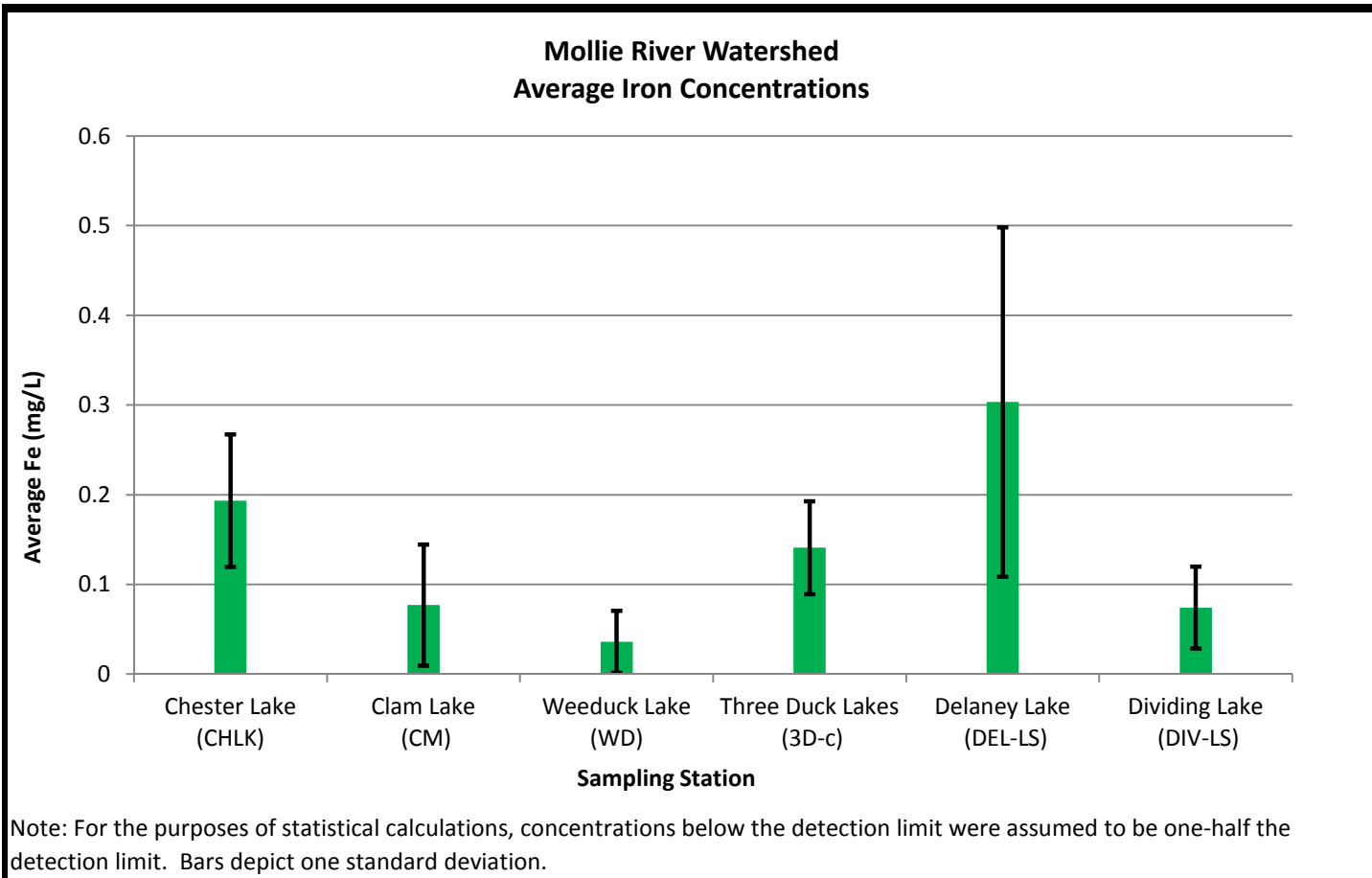

UPDATED BASELINE SURFACE WATER QUALITY DATASET - AVERAGE PARAMETER CONCENTRATIONS, MOLLIE RIVER WATERSHED
CÔTÉ GOLD PROJECT

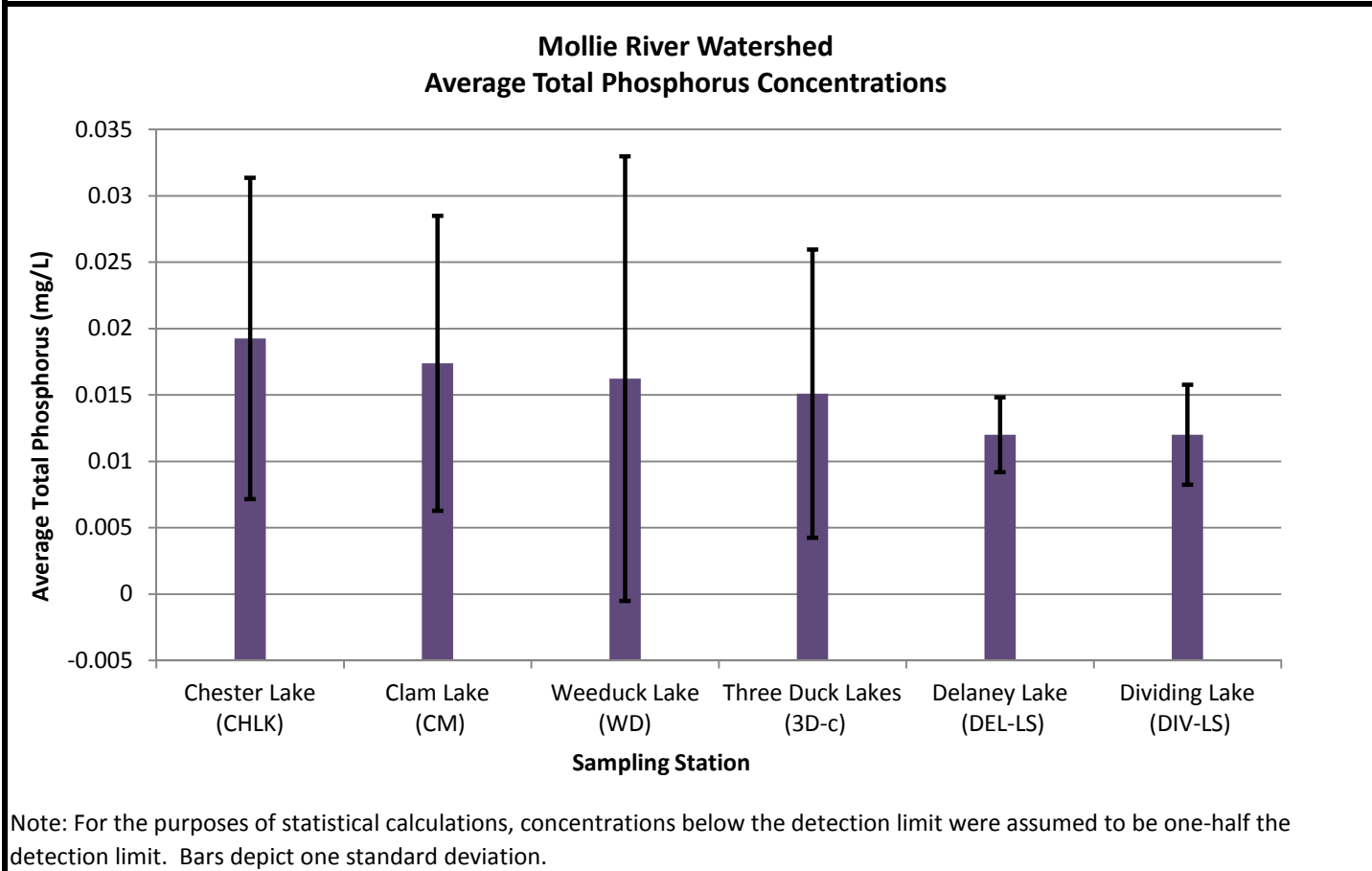
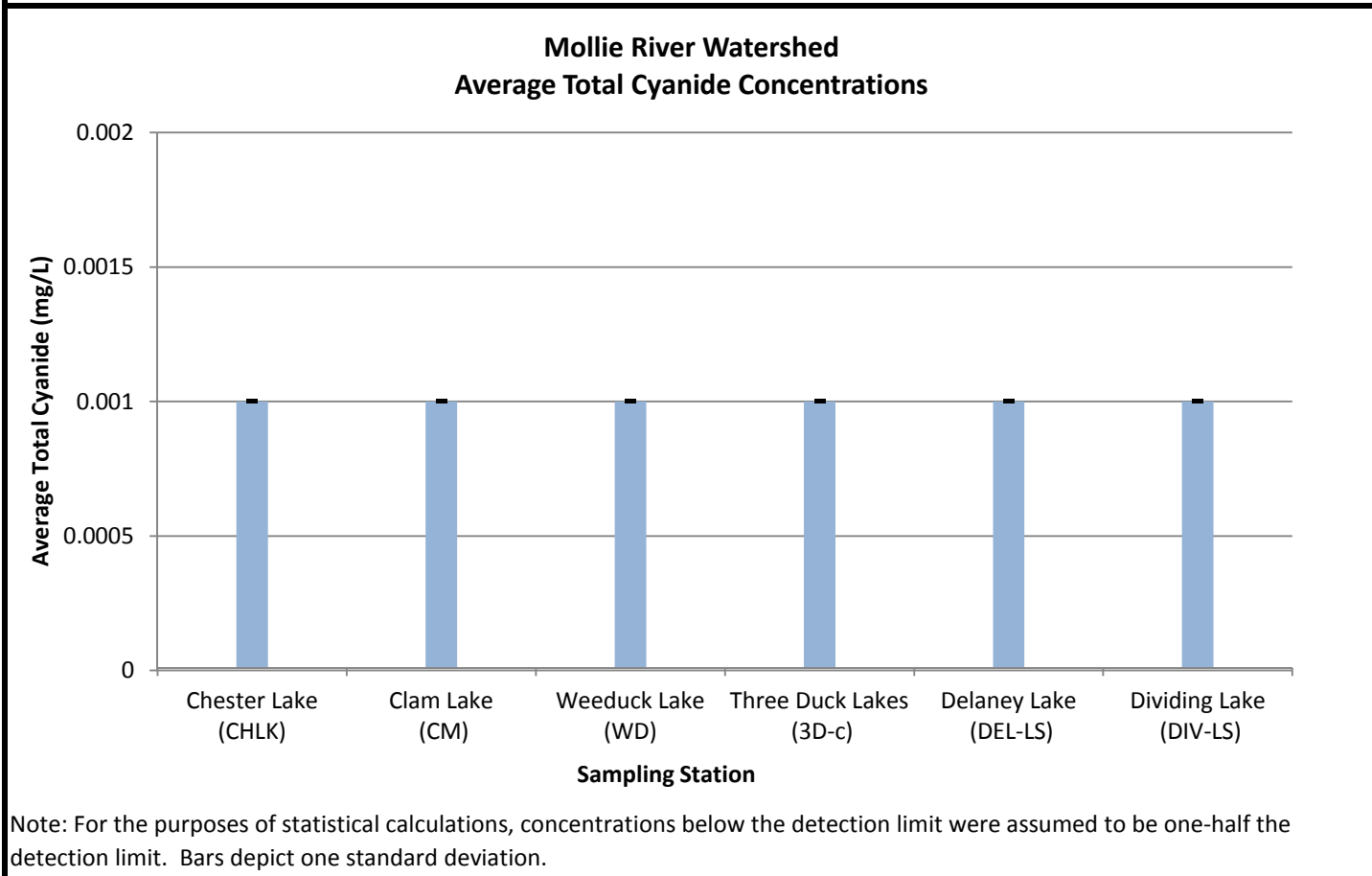
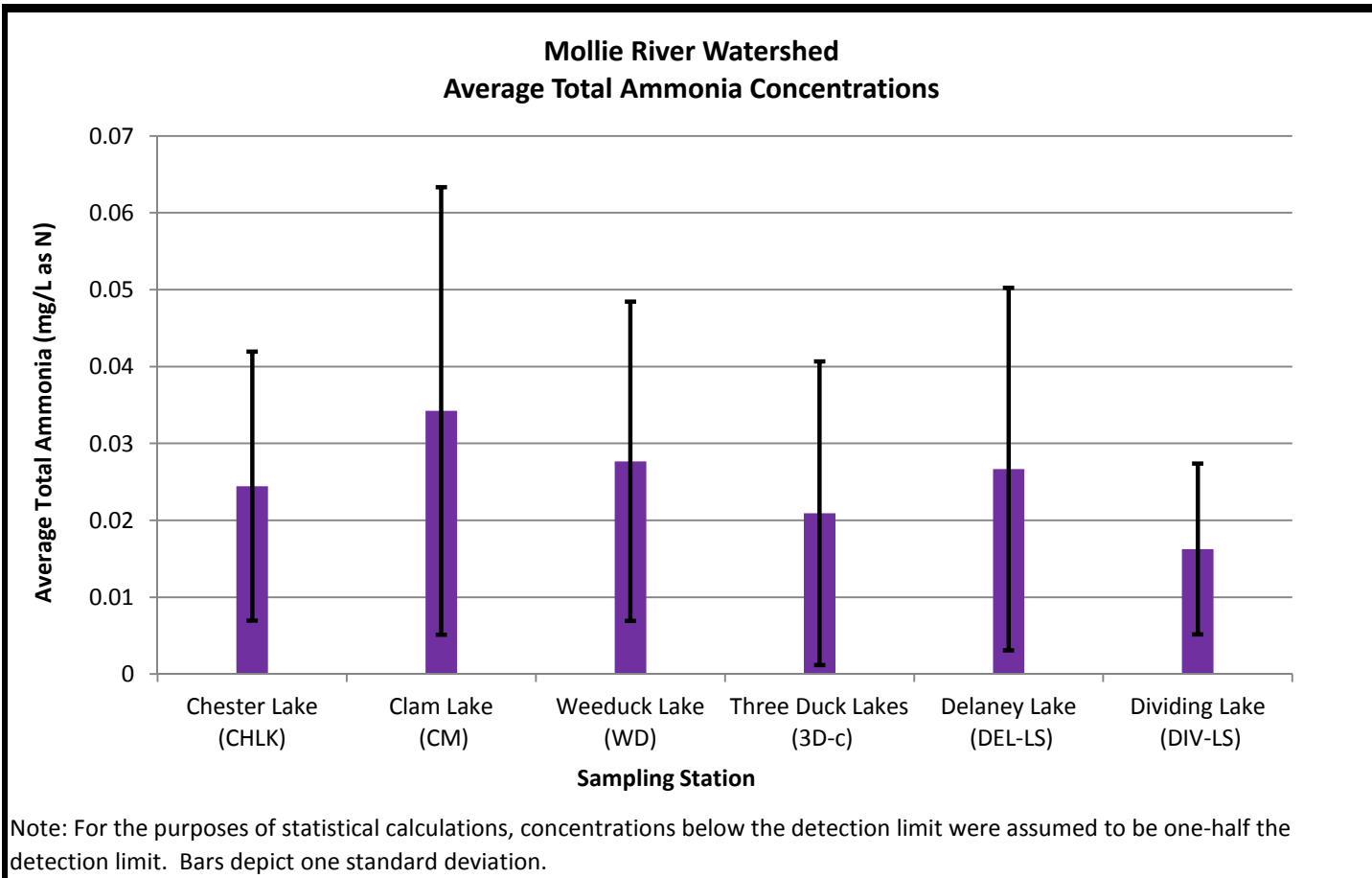

UPDATED BASELINE SURFACE WATER QUALITY DATASET - AVERAGE PARAMETER CONCENTRATIONS, MOLLIE RIVER WATERSHED
CÔTÉ GOLD PROJECT

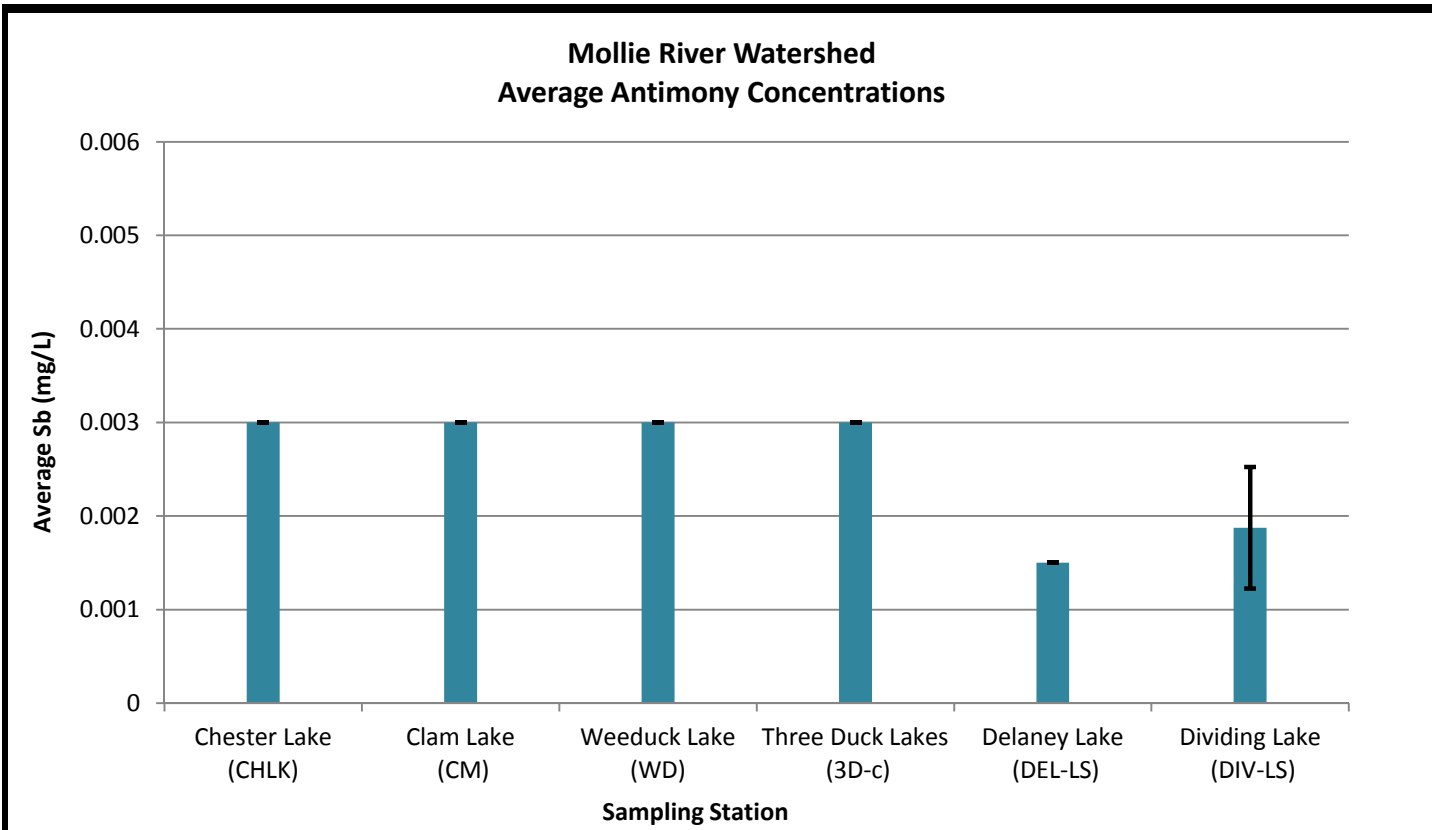

Note: For the purposes of statistical calculations, concentrations below the detection limit were assumed to be one-half the detection limit. Bars depict one standard deviation.

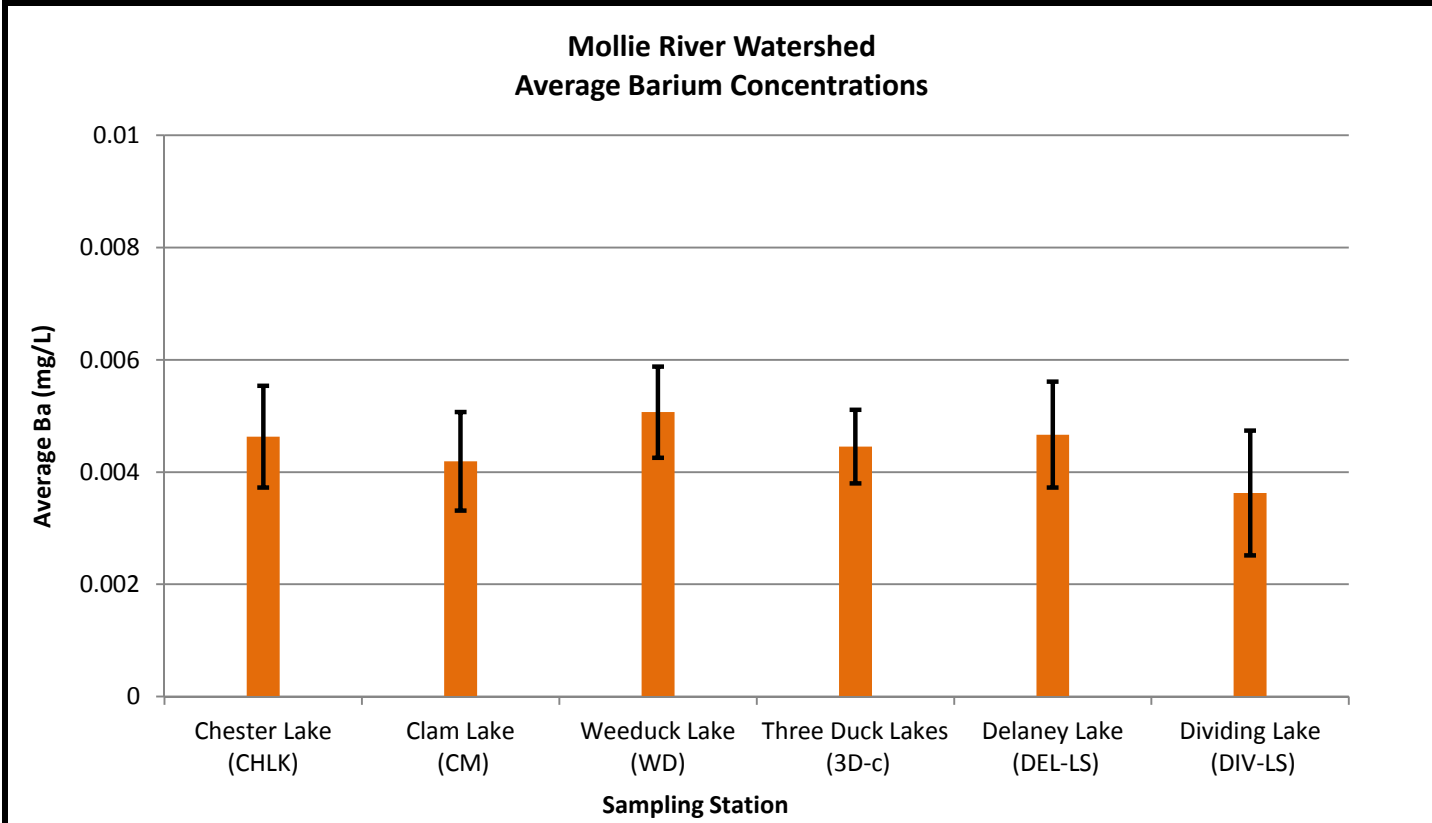

Note: For the purposes of statistical calculations, concentrations below the detection limit were assumed to be one-half the detection limit. Bars depict one standard deviation.

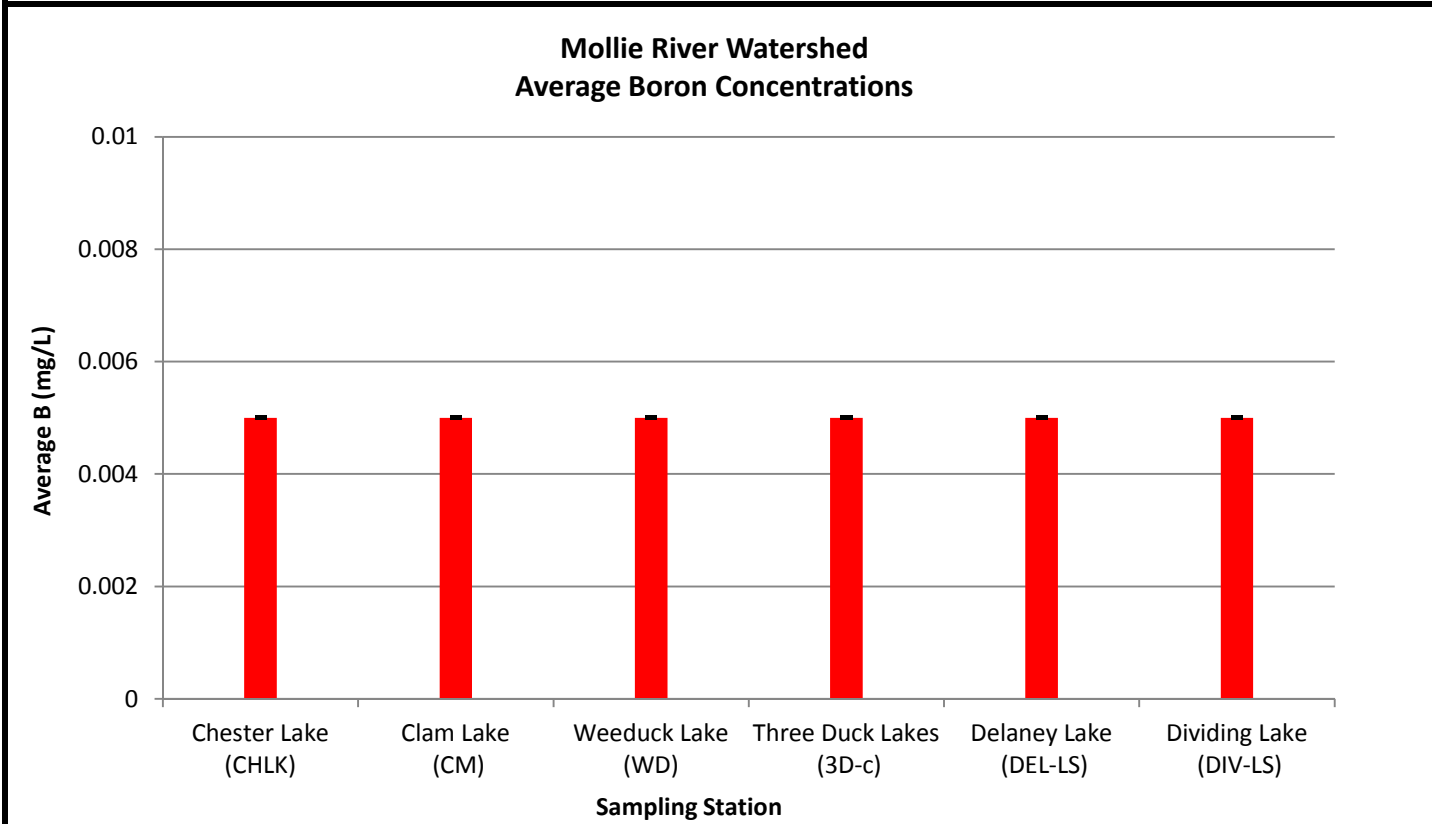

Note: For the purposes of statistical calculations, concentrations below the detection limit were assumed to be one-half the detection limit. Bars depict one standard deviation.

UPDATED BASELINE SURFACE WATER QUALITY DATASET - AVERAGE PARAMETER CONCENTRATIONS, MOLLIE RIVER WATERSHED
CÔTÉ GOLD PROJECT

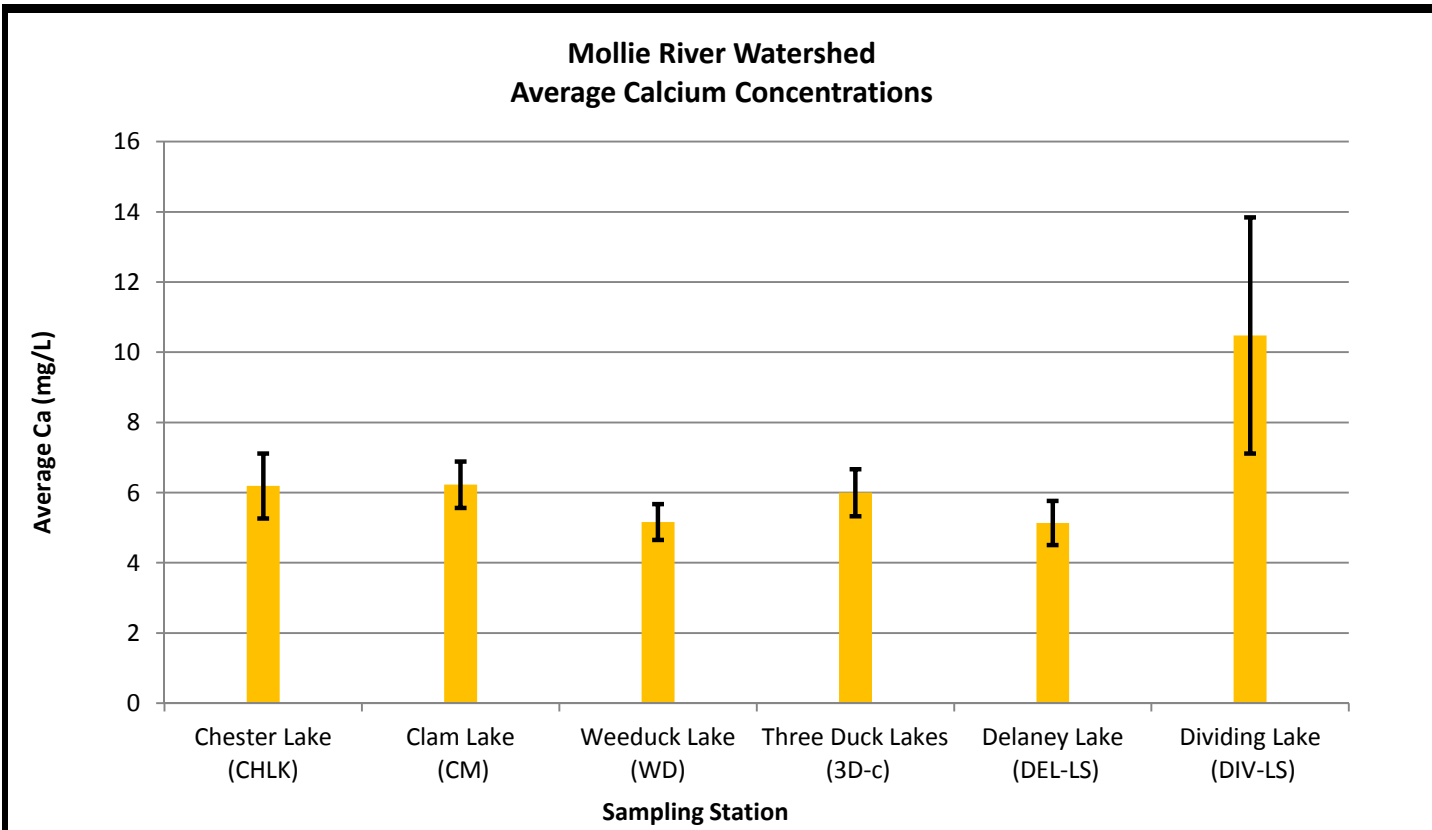

Note: For the purposes of statistical calculations, concentrations below the detection limit were assumed to be one-half the detection limit. Bars depict one standard deviation.

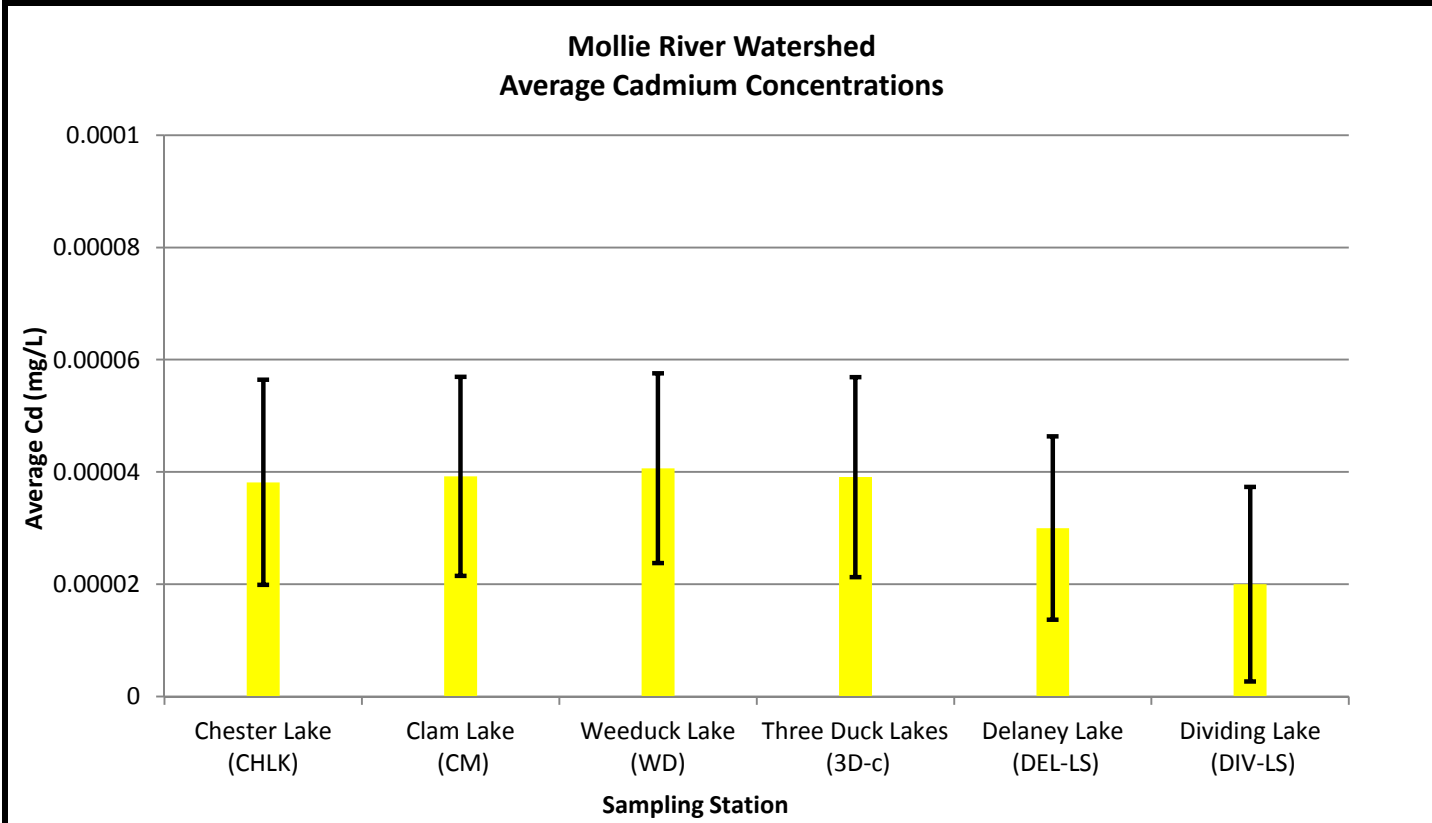

Note: For the purposes of statistical calculations, concentrations below the detection limit were assumed to be one-half the detection limit. Bars depict one standard deviation.

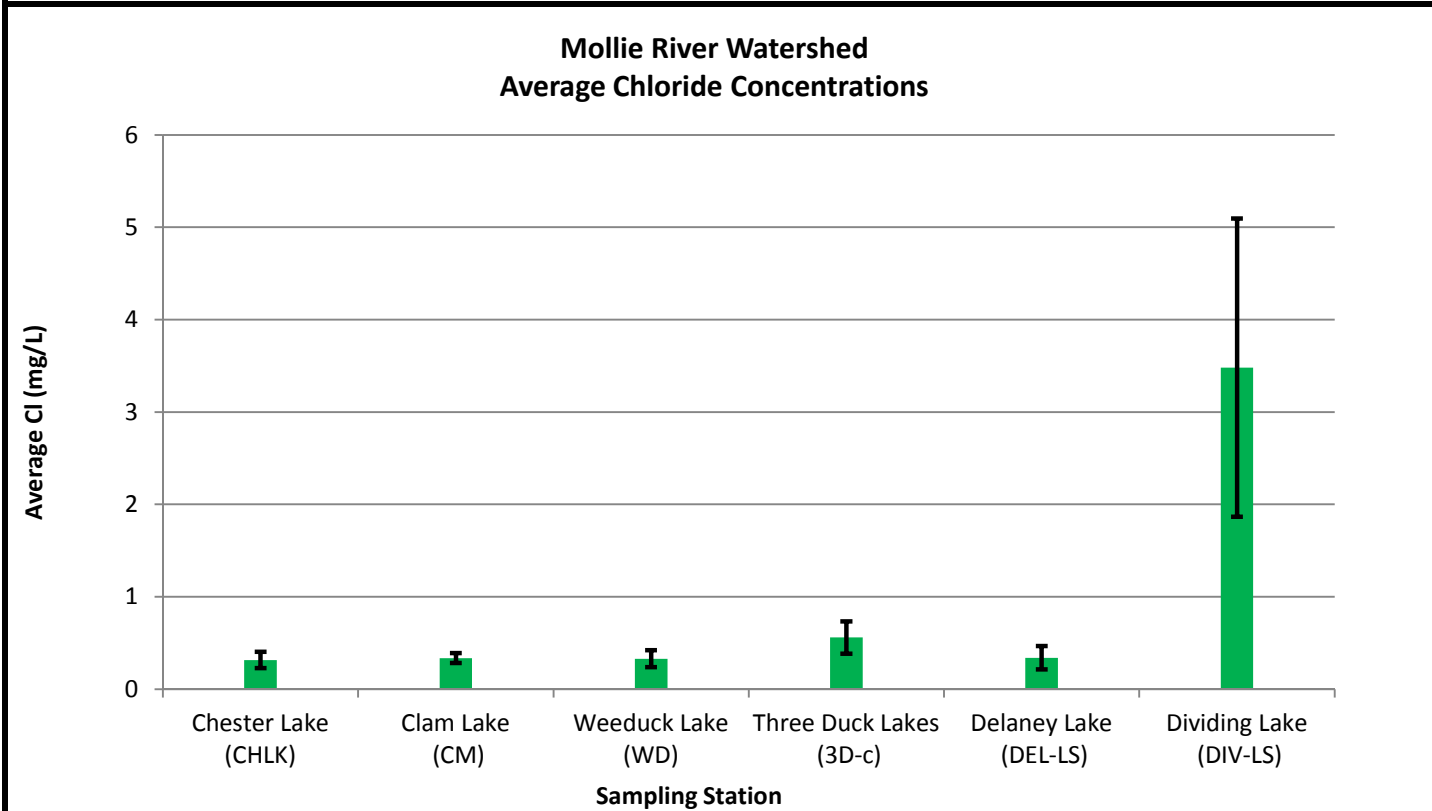

Note: For the purposes of statistical calculations, concentrations below the detection limit were assumed to be one-half the detection limit. Bars depict one standard deviation.

UPDATED BASELINE SURFACE WATER QUALITY DATASET - AVERAGE PARAMETER CONCENTRATIONS, MOLLIE RIVER WATERSHED
CÔTÉ GOLD PROJECT

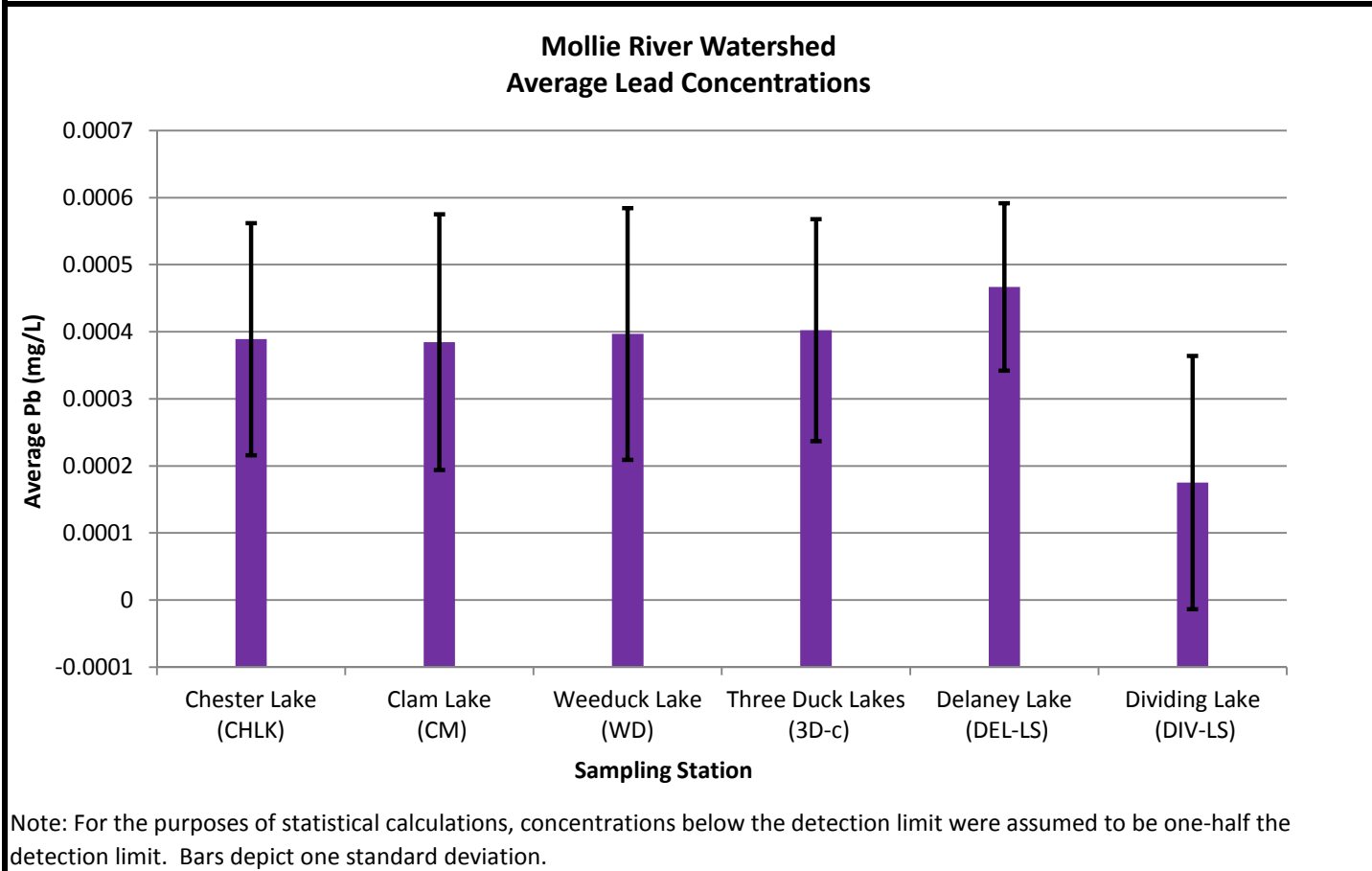
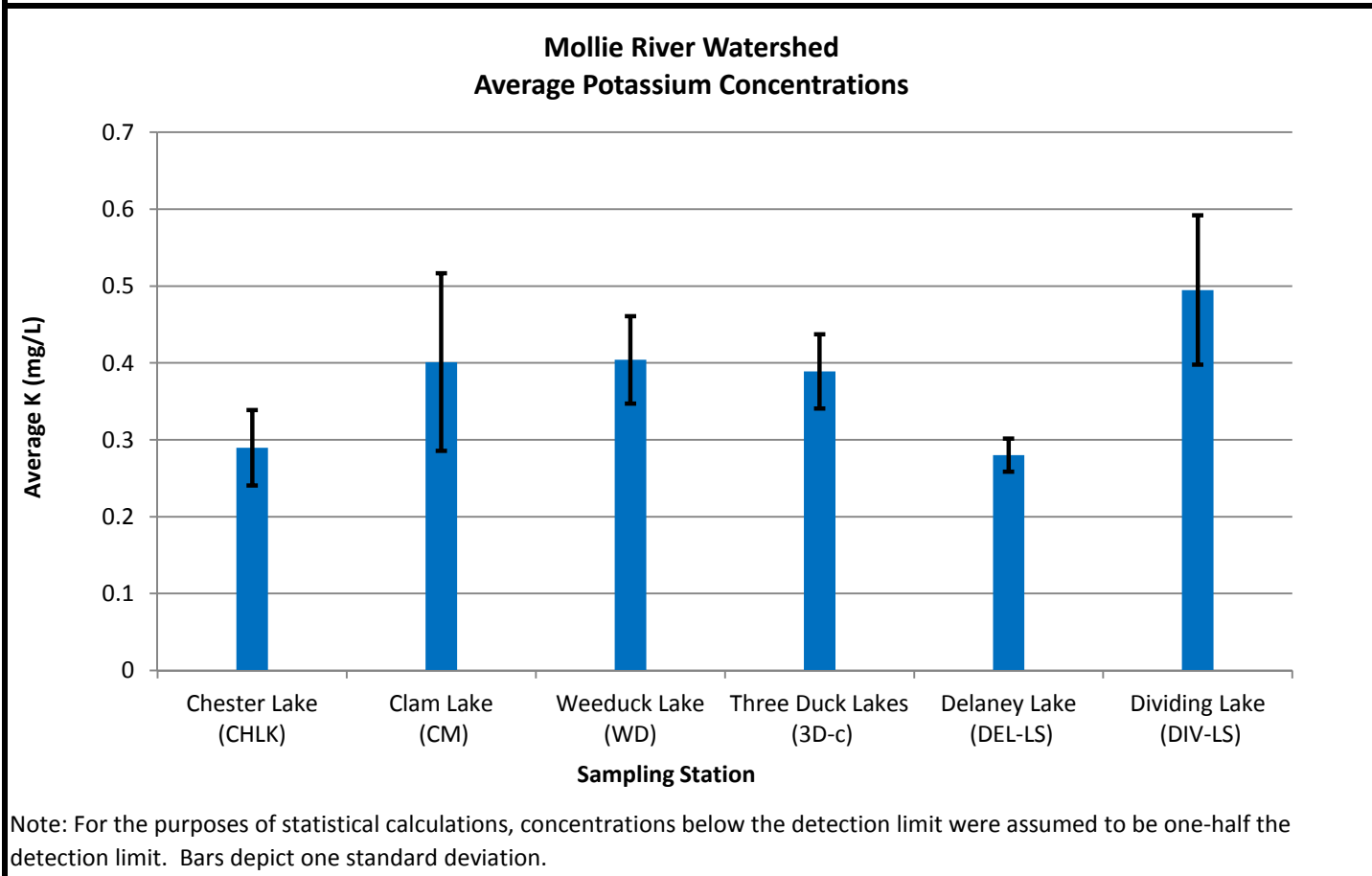
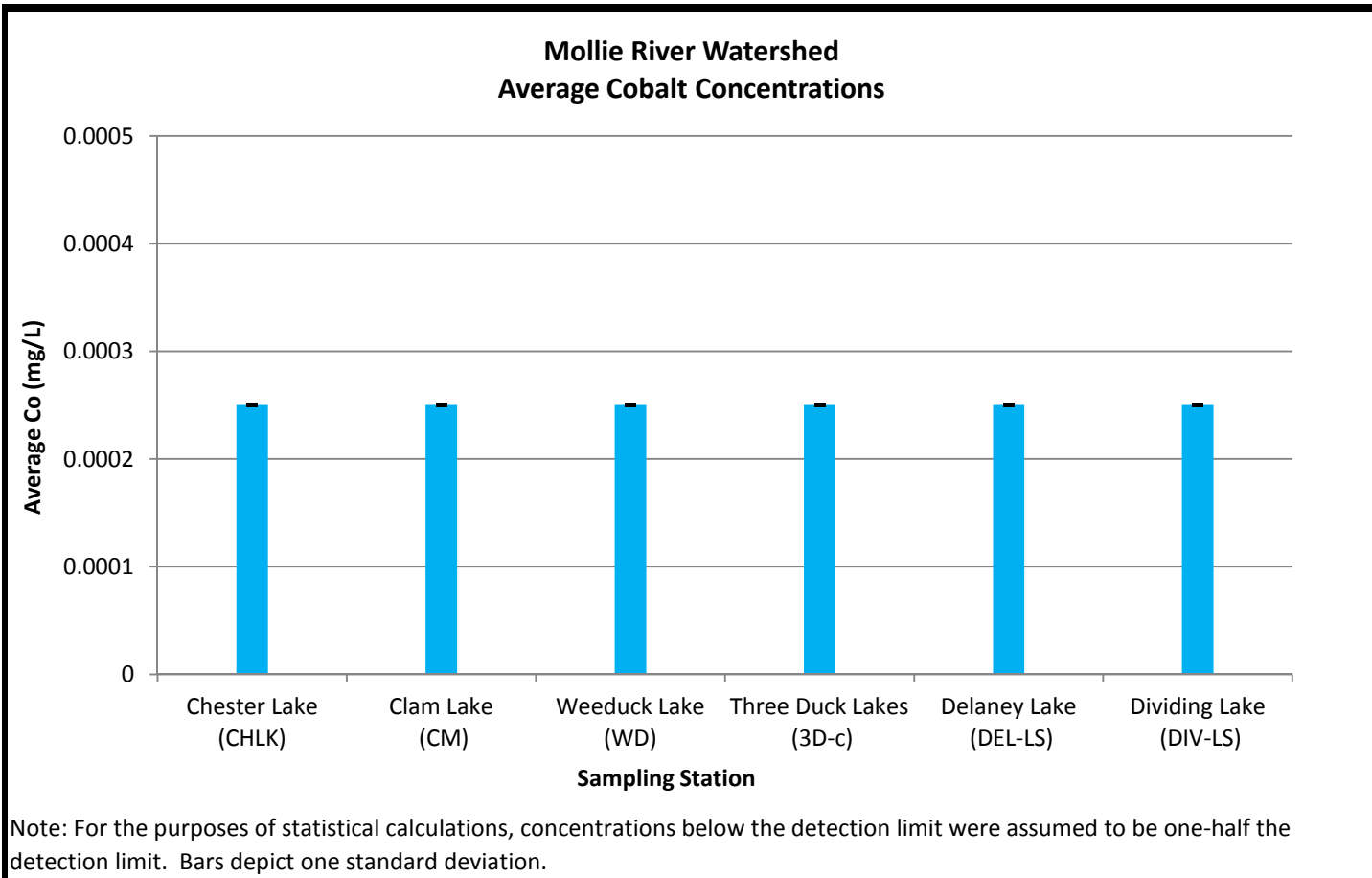

UPDATED BASELINE SURFACE WATER QUALITY DATASET - AVERAGE PARAMETER CONCENTRATIONS, MOLLIE RIVER WATERSHED
CÔTÉ GOLD PROJECT

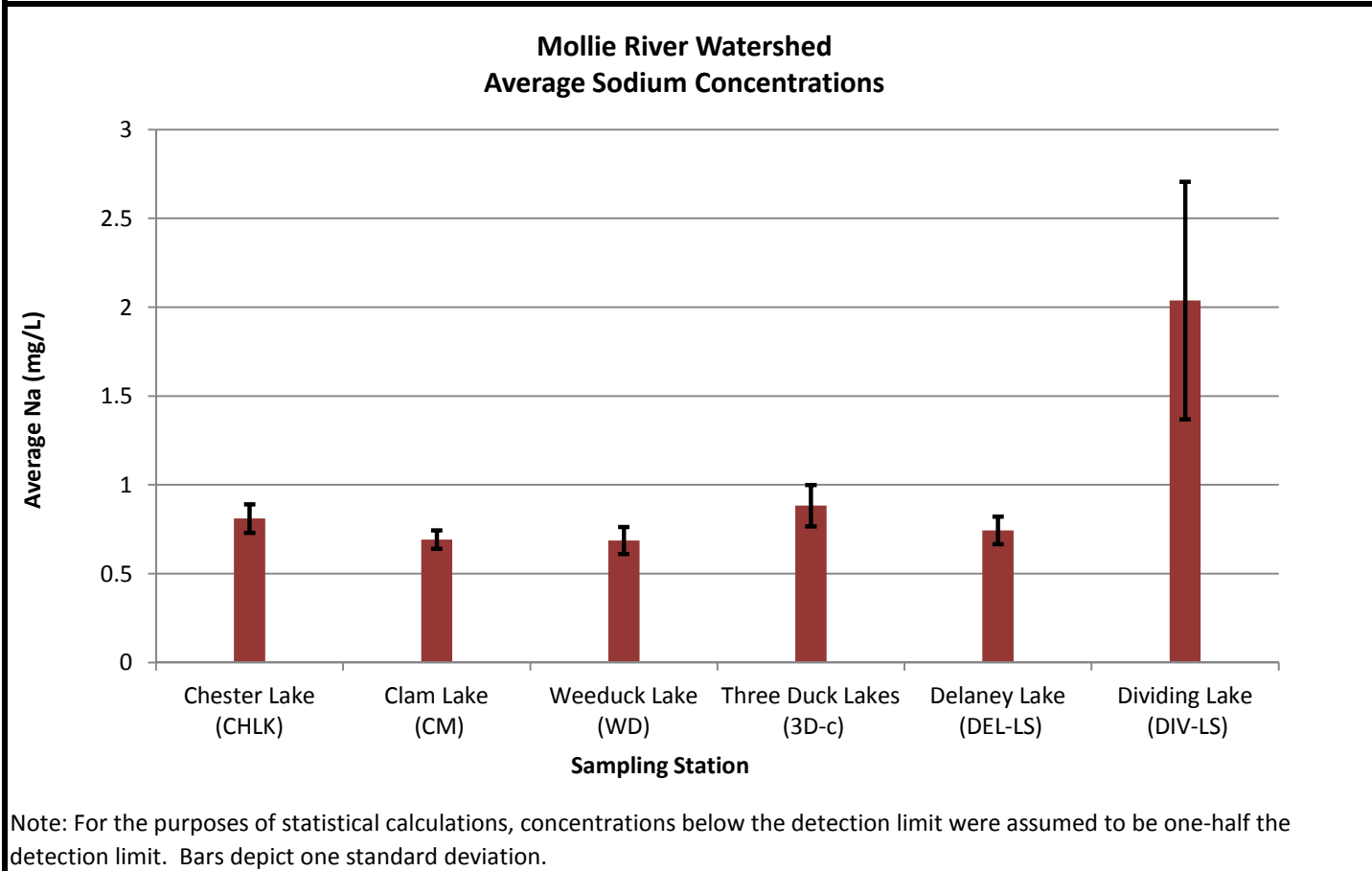
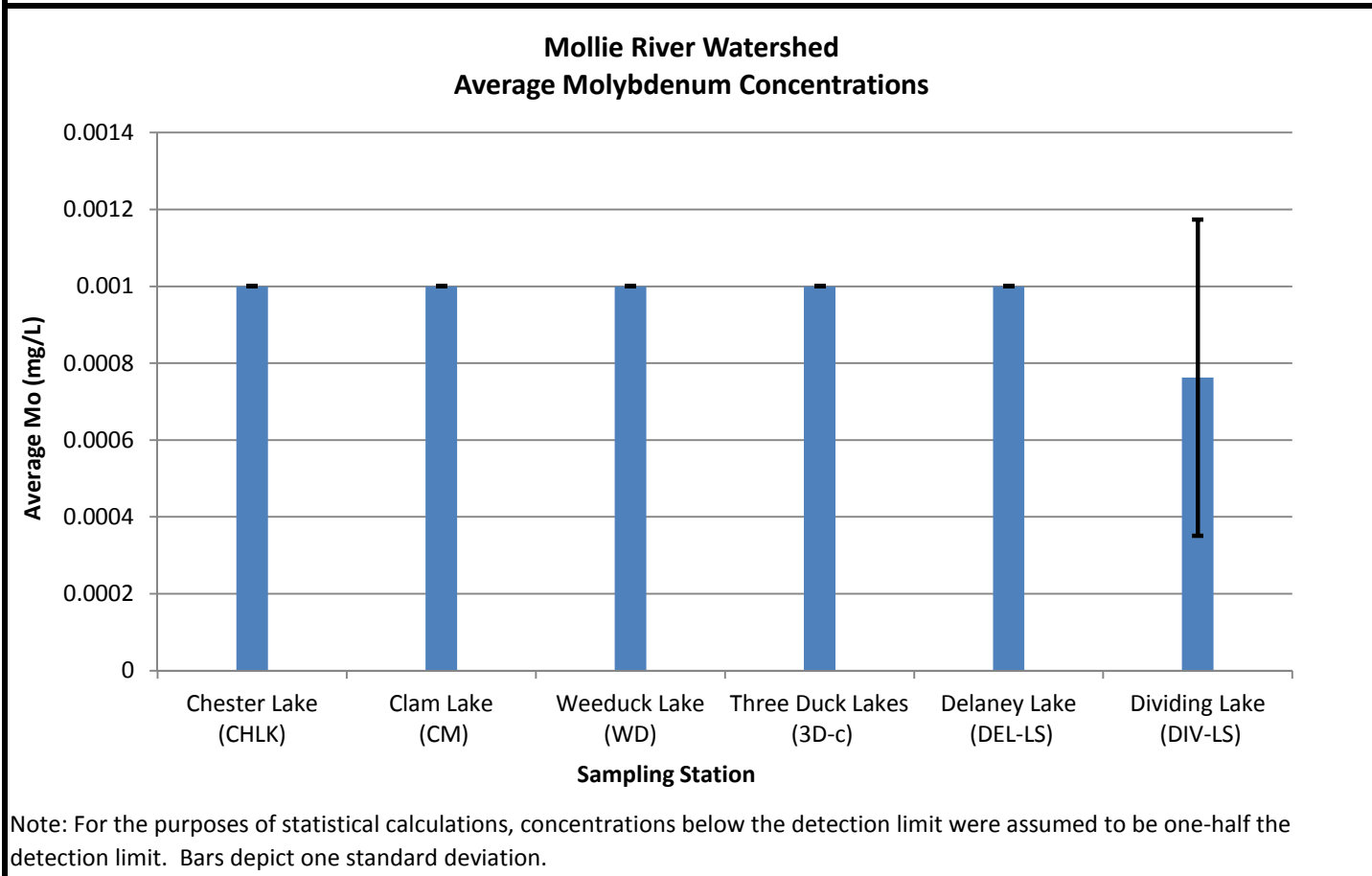
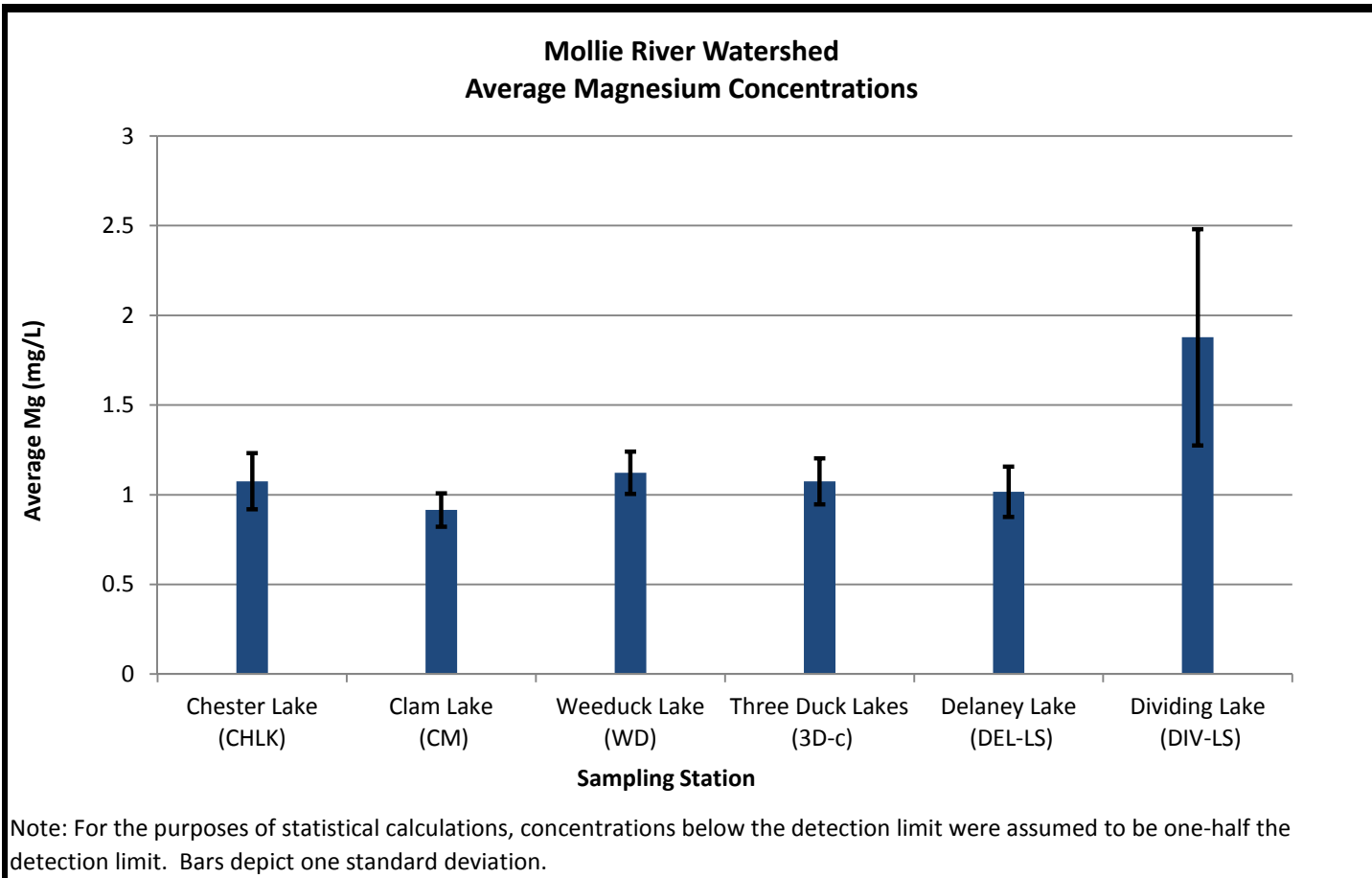

UPDATED BASELINE SURFACE WATER QUALITY DATASET - AVERAGE PARAMETER CONCENTRATIONS, MOLLIE RIVER WATERSHED
CÔTÉ GOLD PROJECT

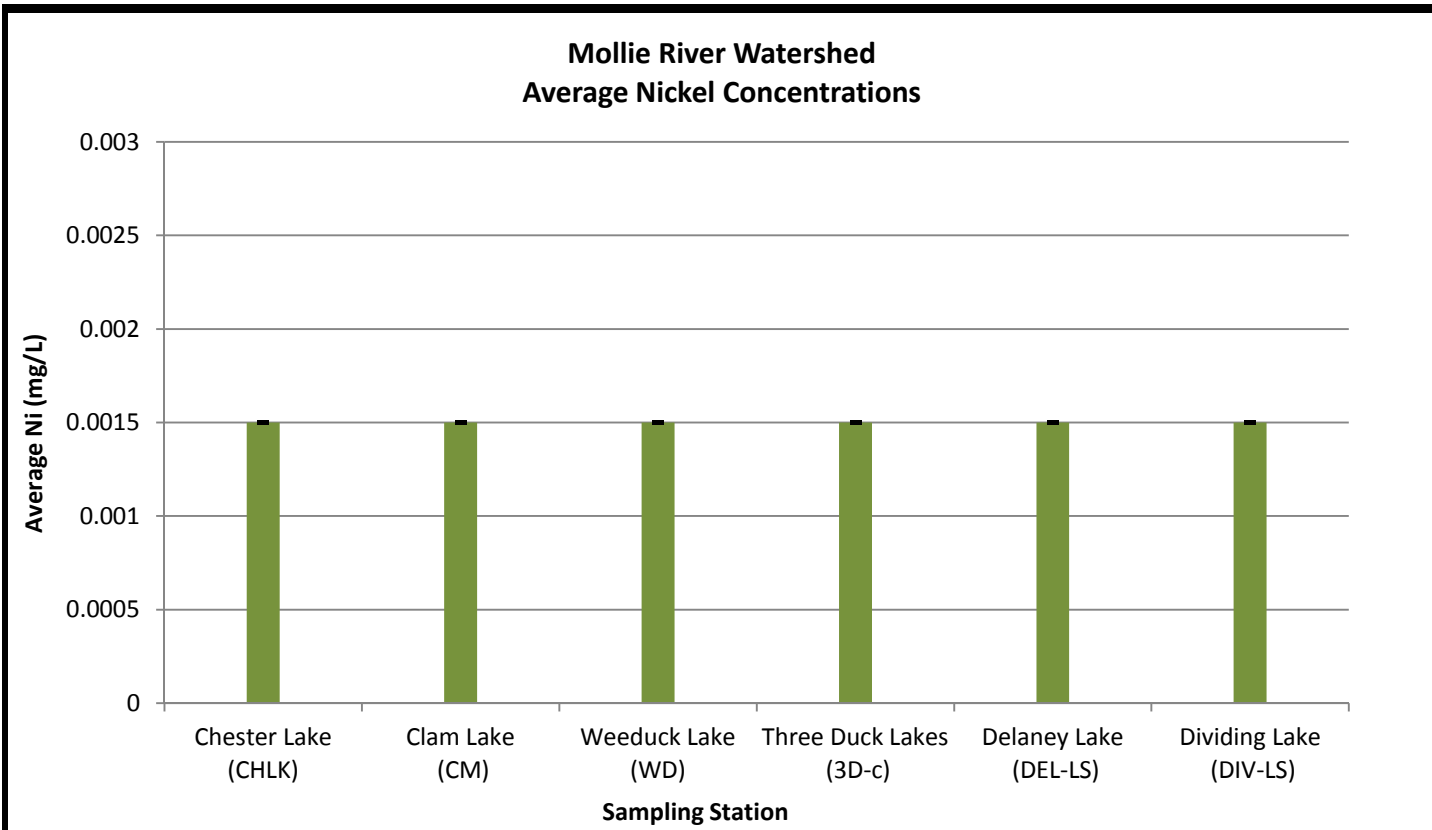

Note: For the purposes of statistical calculations, concentrations below the detection limit were assumed to be one-half the detection limit. Bars depict one standard deviation.

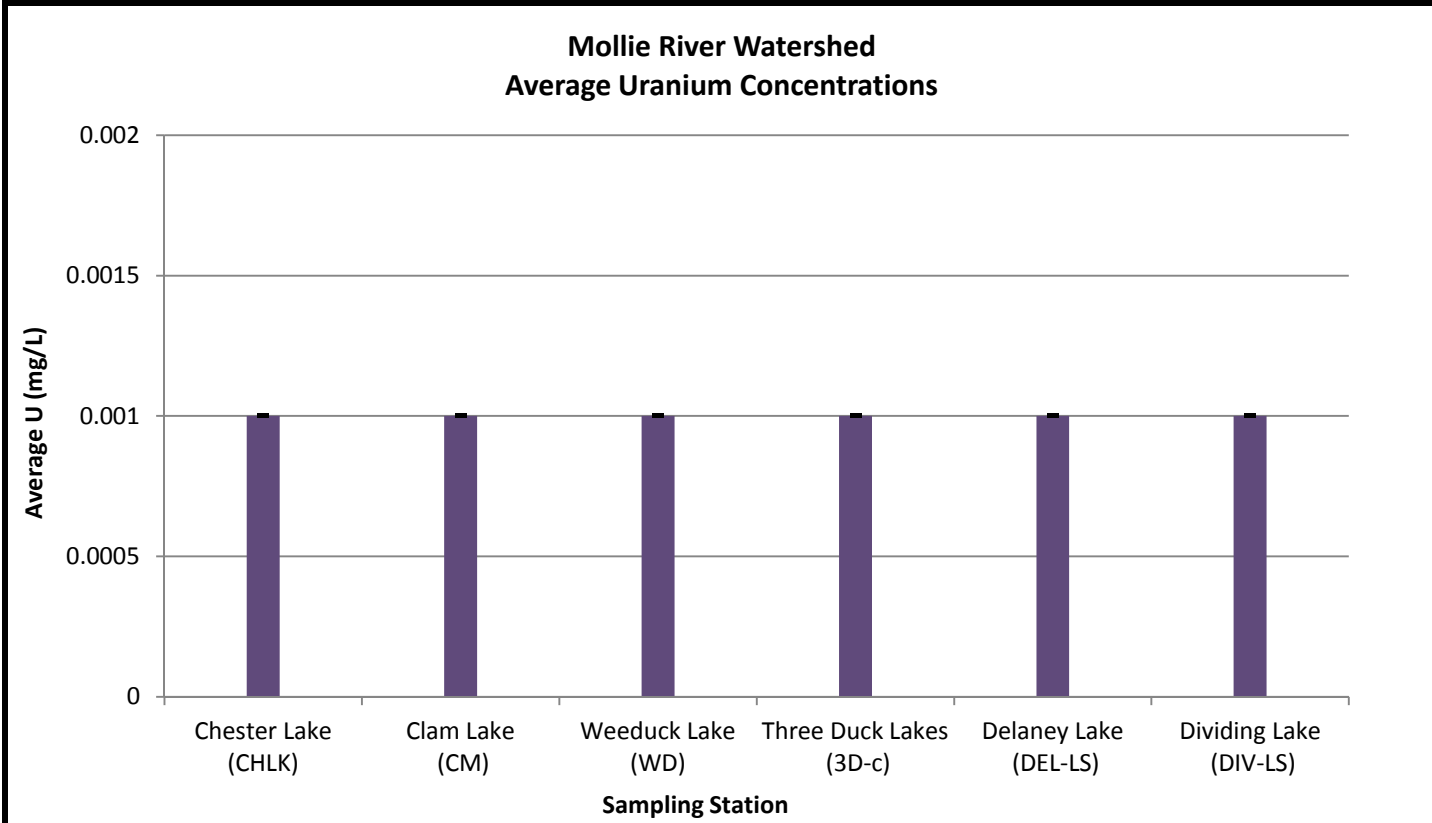

Note: For the purposes of statistical calculations, concentrations below the detection limit were assumed to be one-half the detection limit. Bars depict one standard deviation.

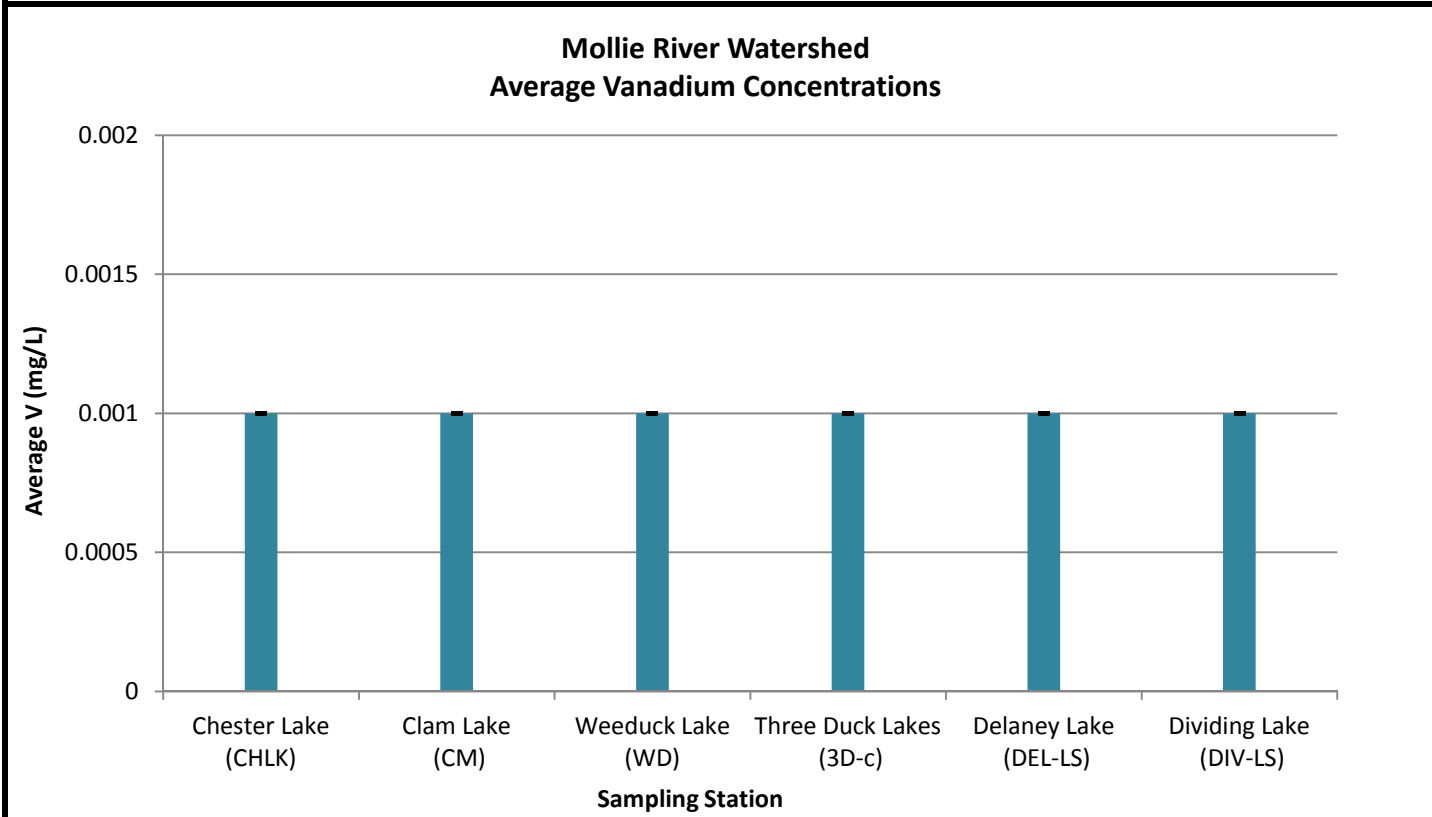

Note: For the purposes of statistical calculations, concentrations below the detection limit were assumed to be one-half the detection limit. Bars depict one standard deviation.

UPDATED BASELINE SURFACE WATER QUALITY DATASET - AVERAGE PARAMETER CONCENTRATIONS, MOLLIE RIVER WATERSHED
CÔTÉ GOLD PROJECT

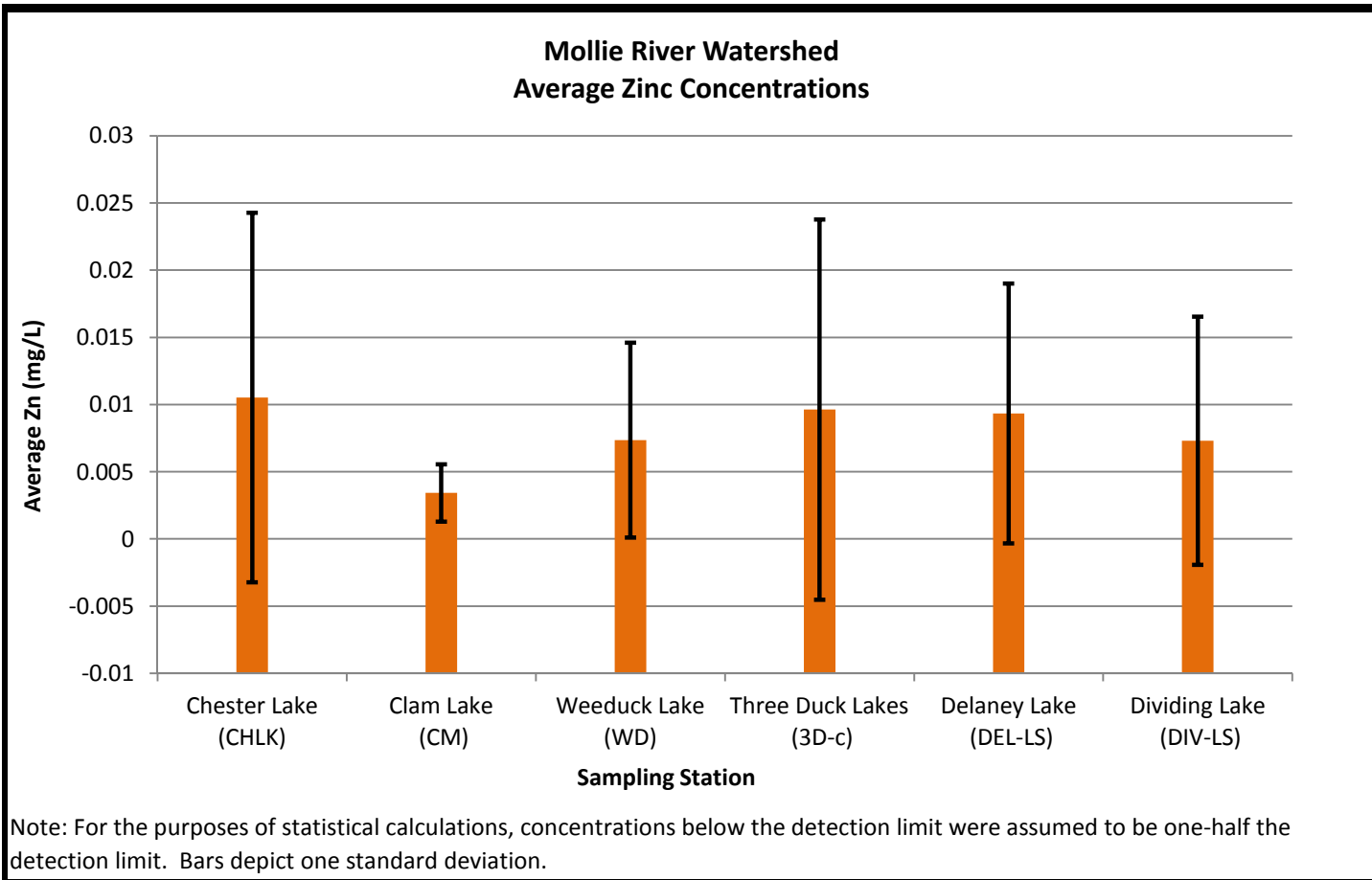

UPDATED BASELINE SURFACE WATER QUALITY DATASET - AVERAGE PARAMETER CONCENTRATIONS, MESOMIKENDA LAKE WATERSHED
CÔTÉ GOLD PROJECT

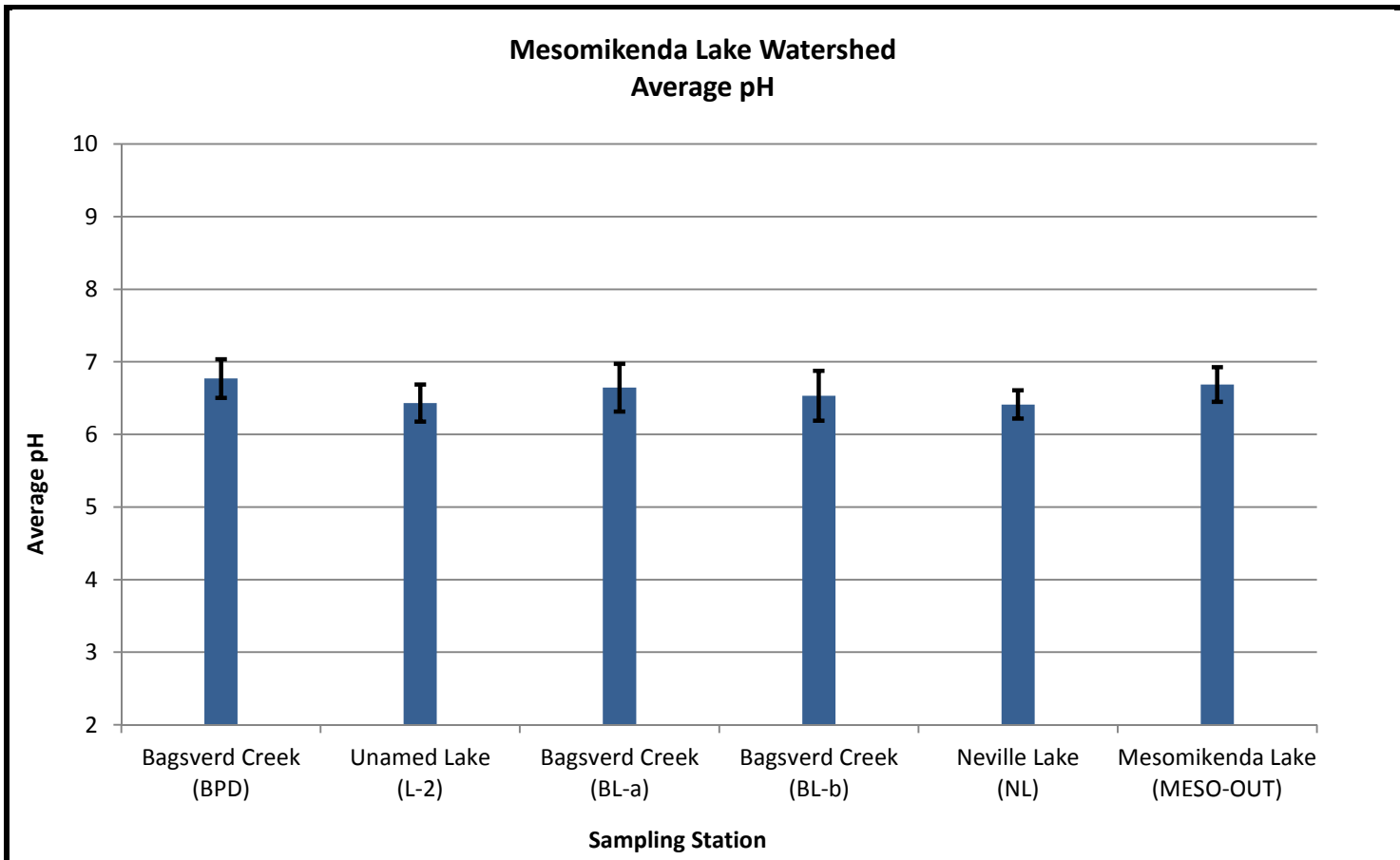

Note: For the purposes of statistical calculations, concentrations below the detection limit were assumed to be one-half the detection limit. Bars depict one standard deviation.

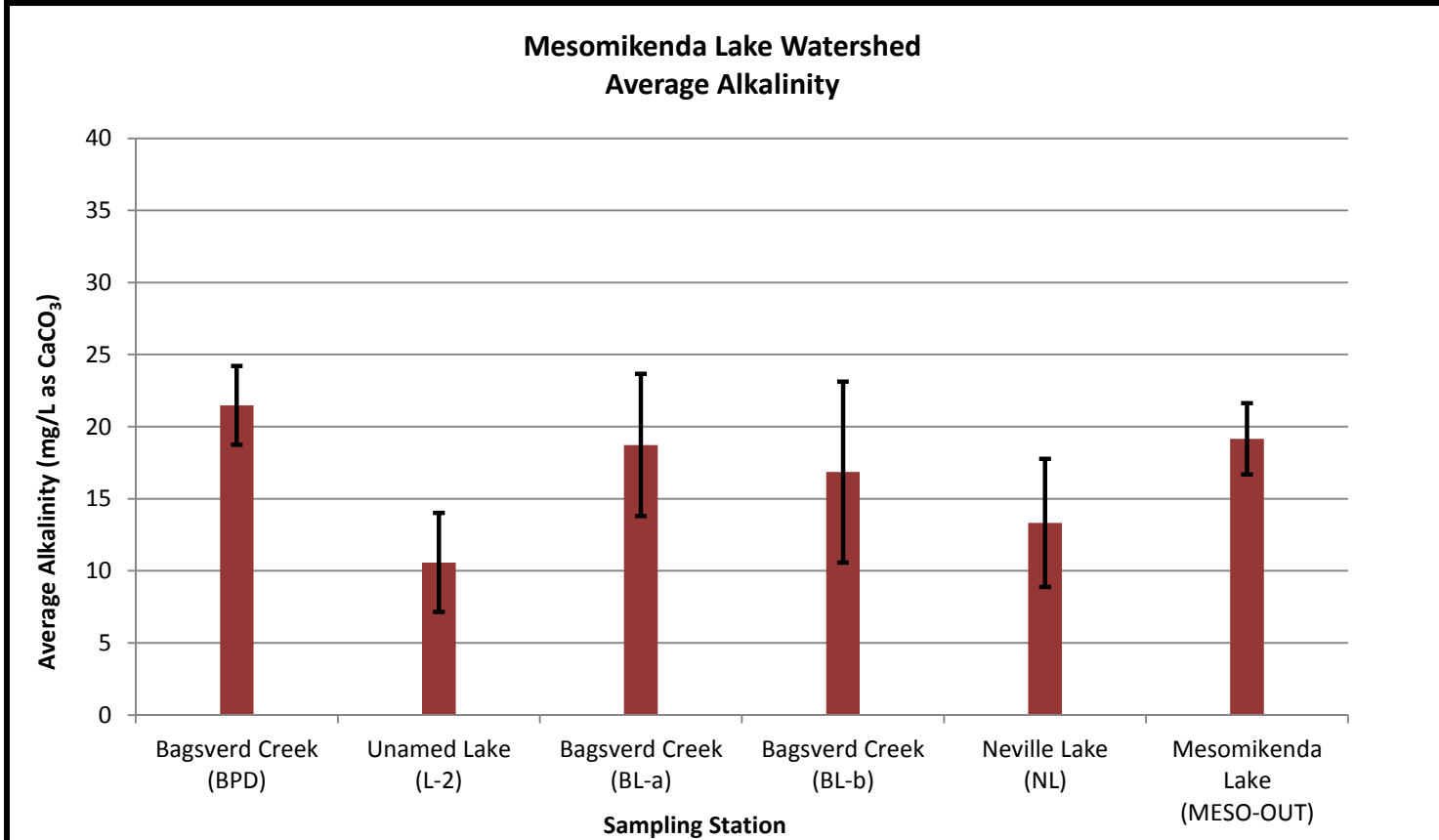

Note: For the purposes of statistical calculations, concentrations below the detection limit were assumed to be one-half the detection limit. Bars depict one standard deviation.

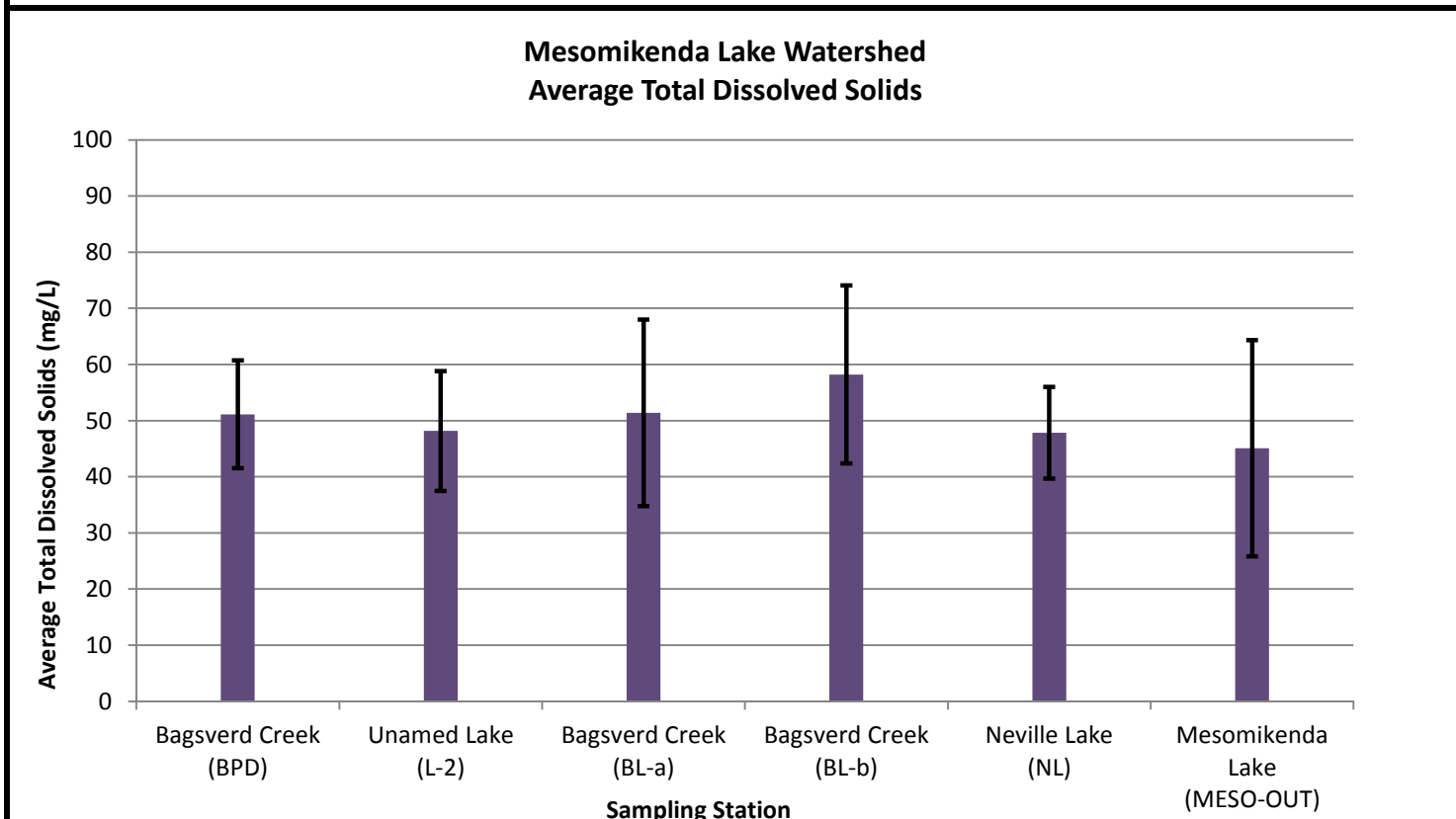

Note: For the purposes of statistical calculations, concentrations below the detection limit were assumed to be one-half the detection limit. Bars depict one standard deviation.

UPDATED BASELINE SURFACE WATER QUALITY DATASET - AVERAGE PARAMETER CONCENTRATIONS, MESOMIKENDA LAKE WATERSHED
CÔTÉ GOLD PROJECT

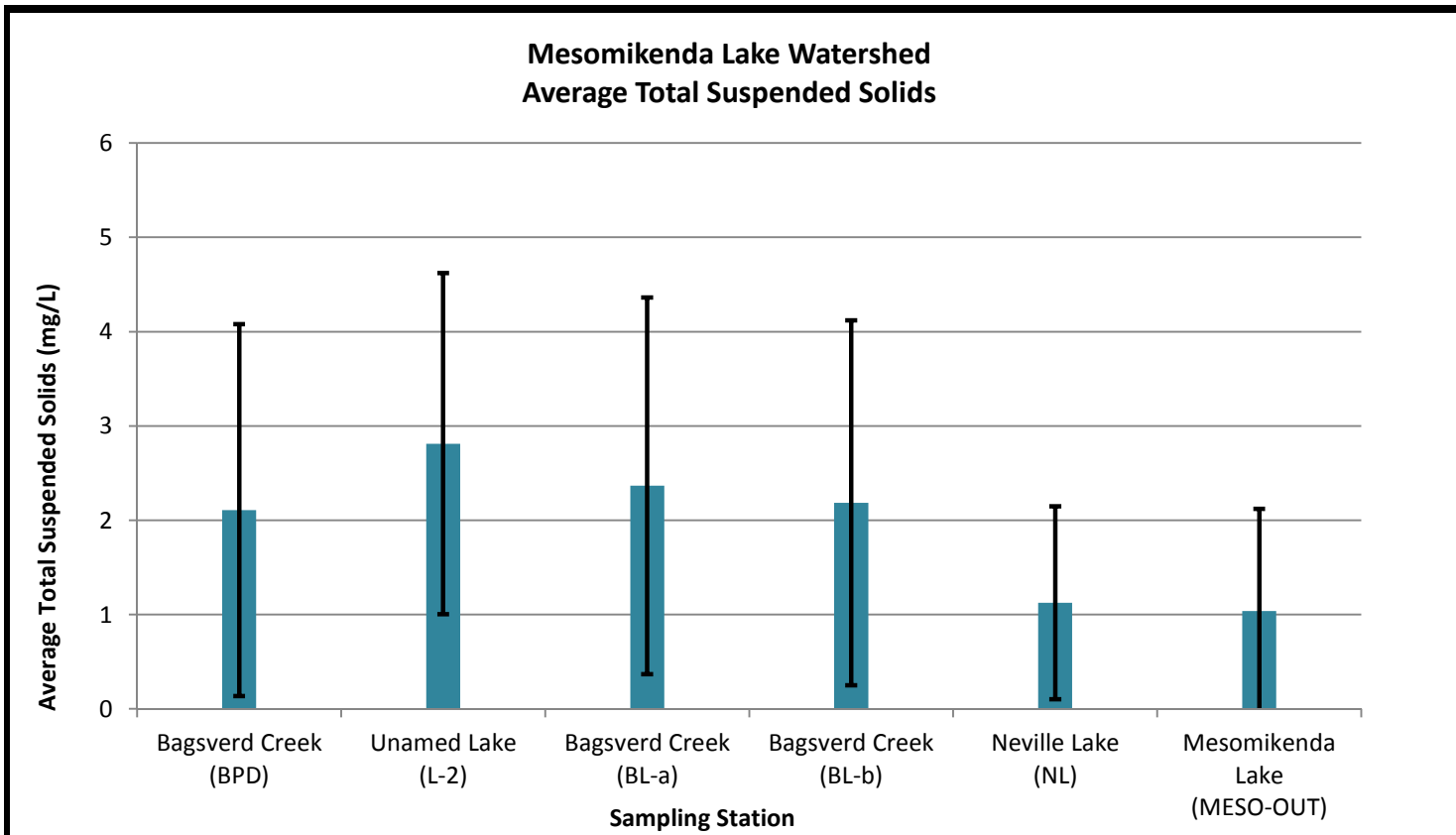

Note: For the purposes of statistical calculations, concentrations below the detection limit were assumed to be one-half the detection limit. Bars depict one standard deviation.

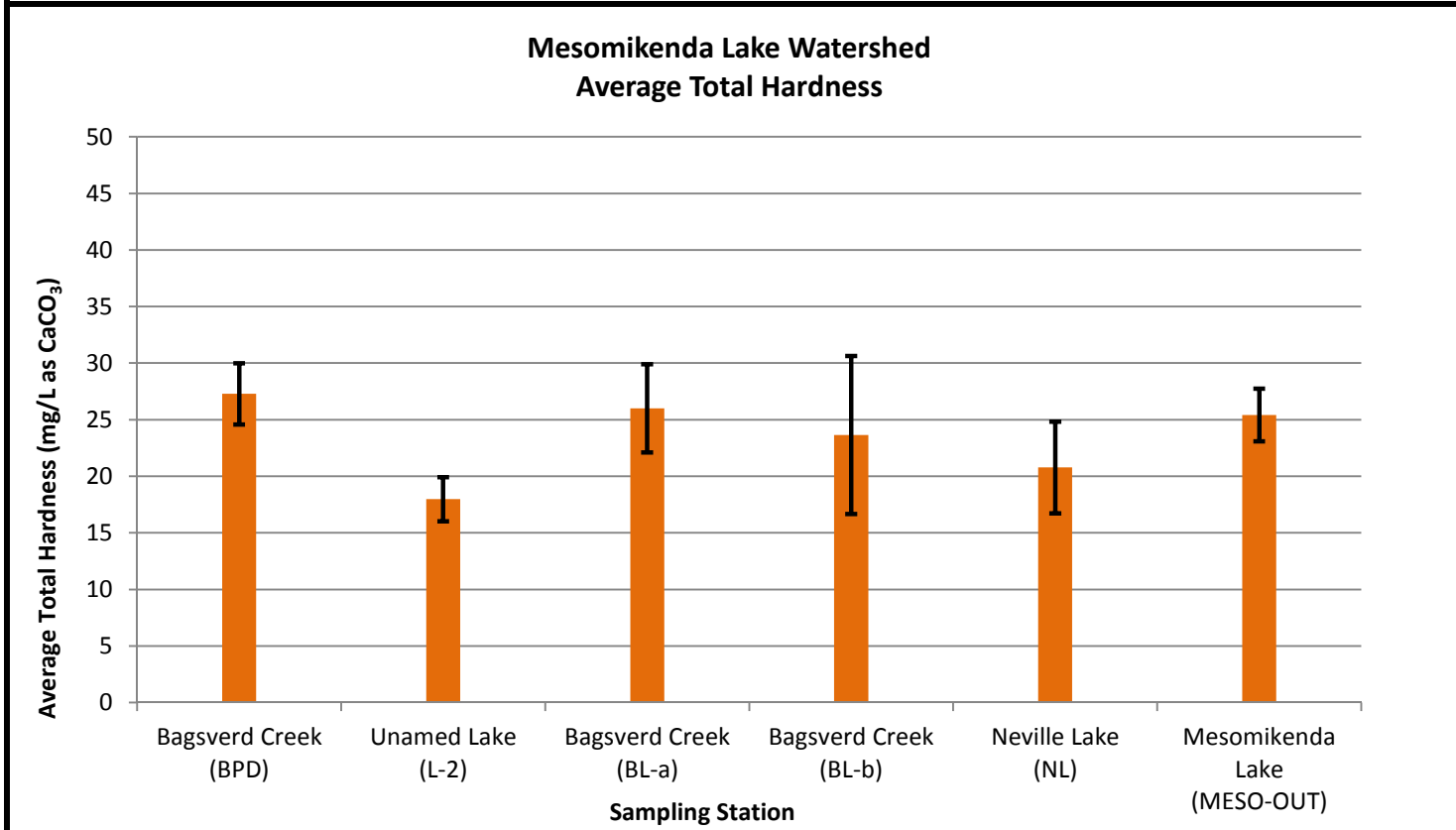

Note: For the purposes of statistical calculations, concentrations below the detection limit were assumed to be one-half the detection limit. Bars depict one standard deviation.

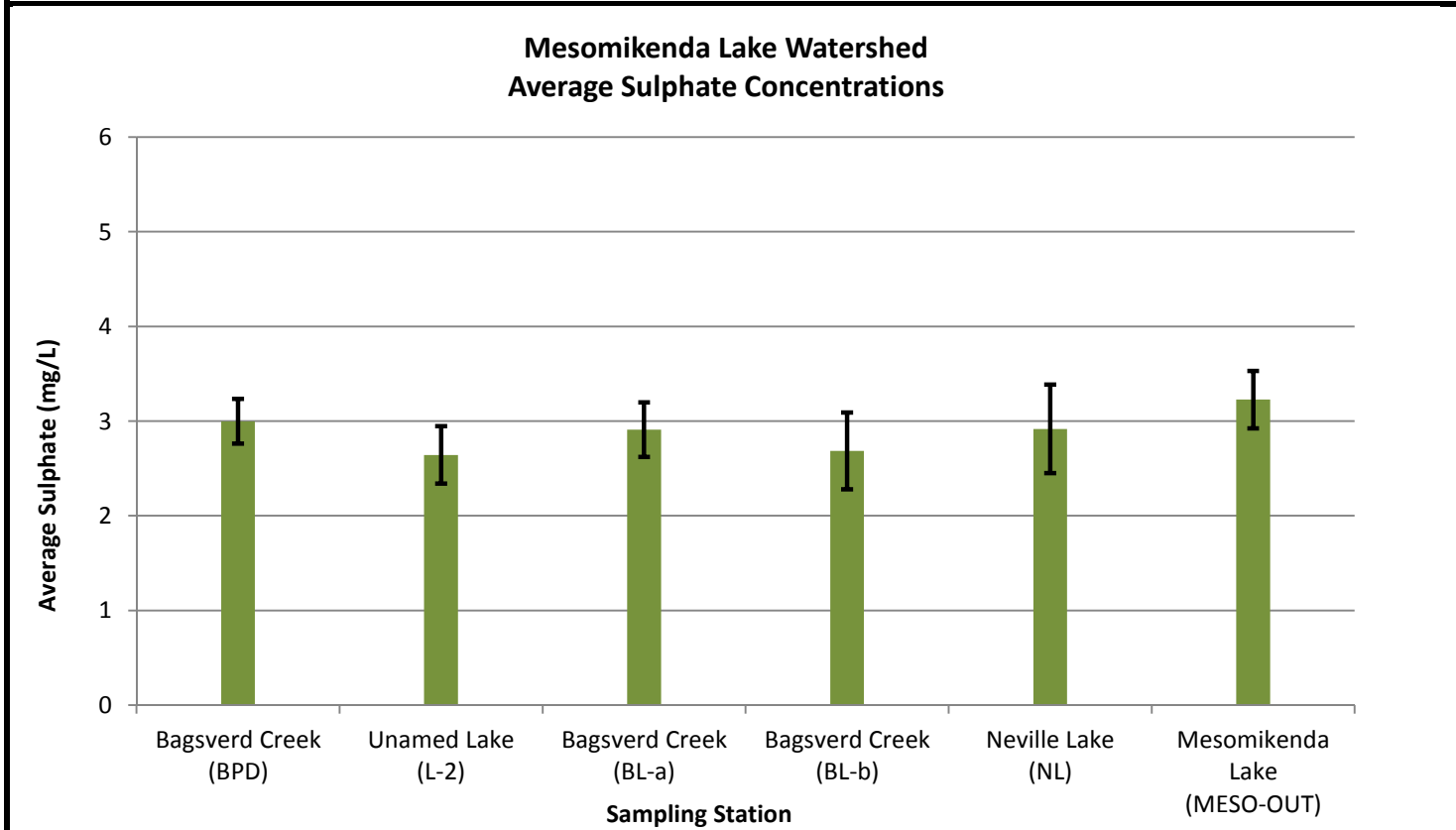

Note: For the purposes of statistical calculations, concentrations below the detection limit were assumed to be one-half the detection limit. Bars depict one standard deviation.

UPDATED BASELINE SURFACE WATER QUALITY DATASET - AVERAGE PARAMETER CONCENTRATIONS, MESOMIKENDA LAKE WATERSHED
CÔTÉ GOLD PROJECT

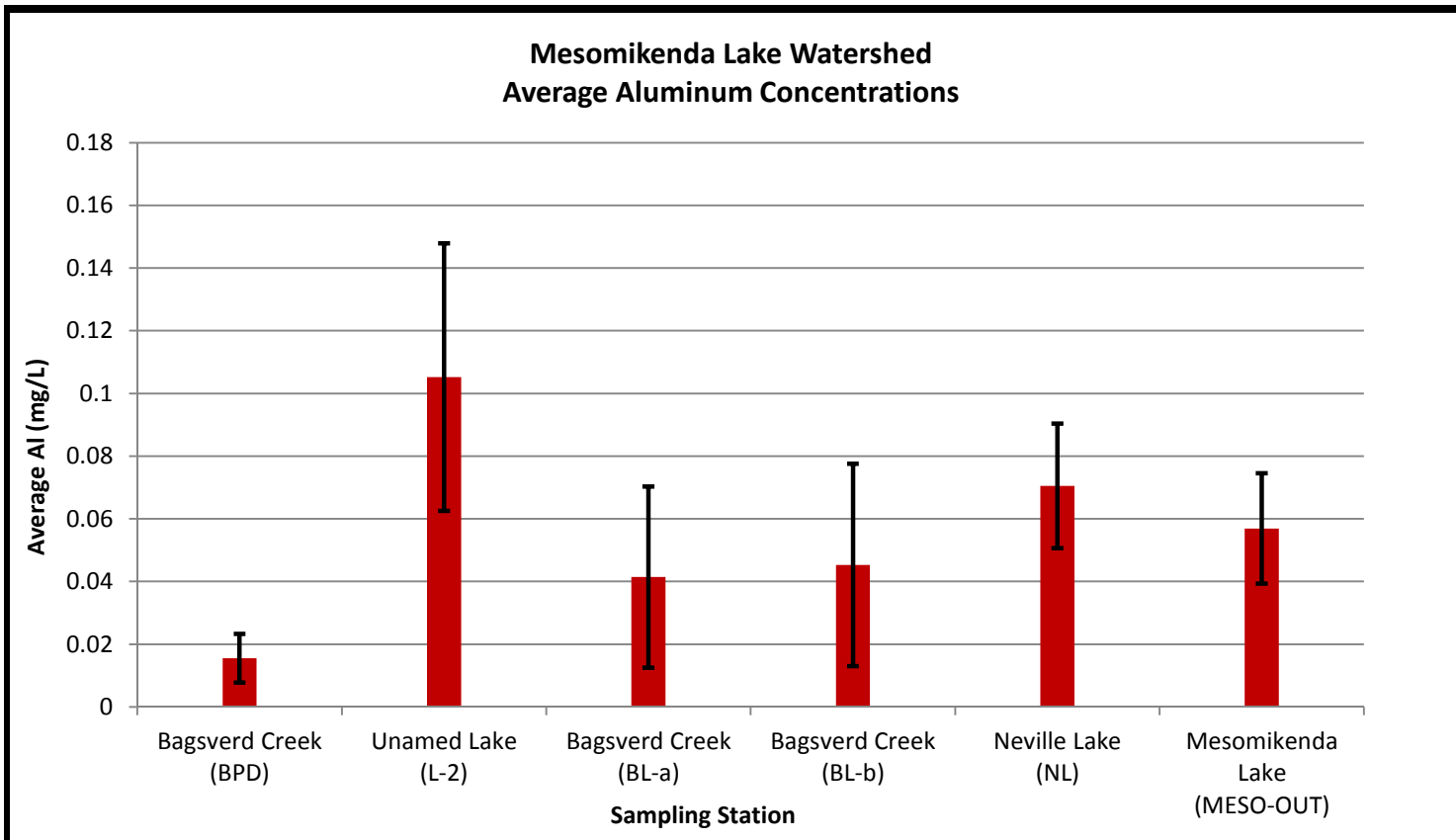

Note: For the purposes of statistical calculations, concentrations below the detection limit were assumed to be one-half the detection limit. Bars depict one standard deviation.

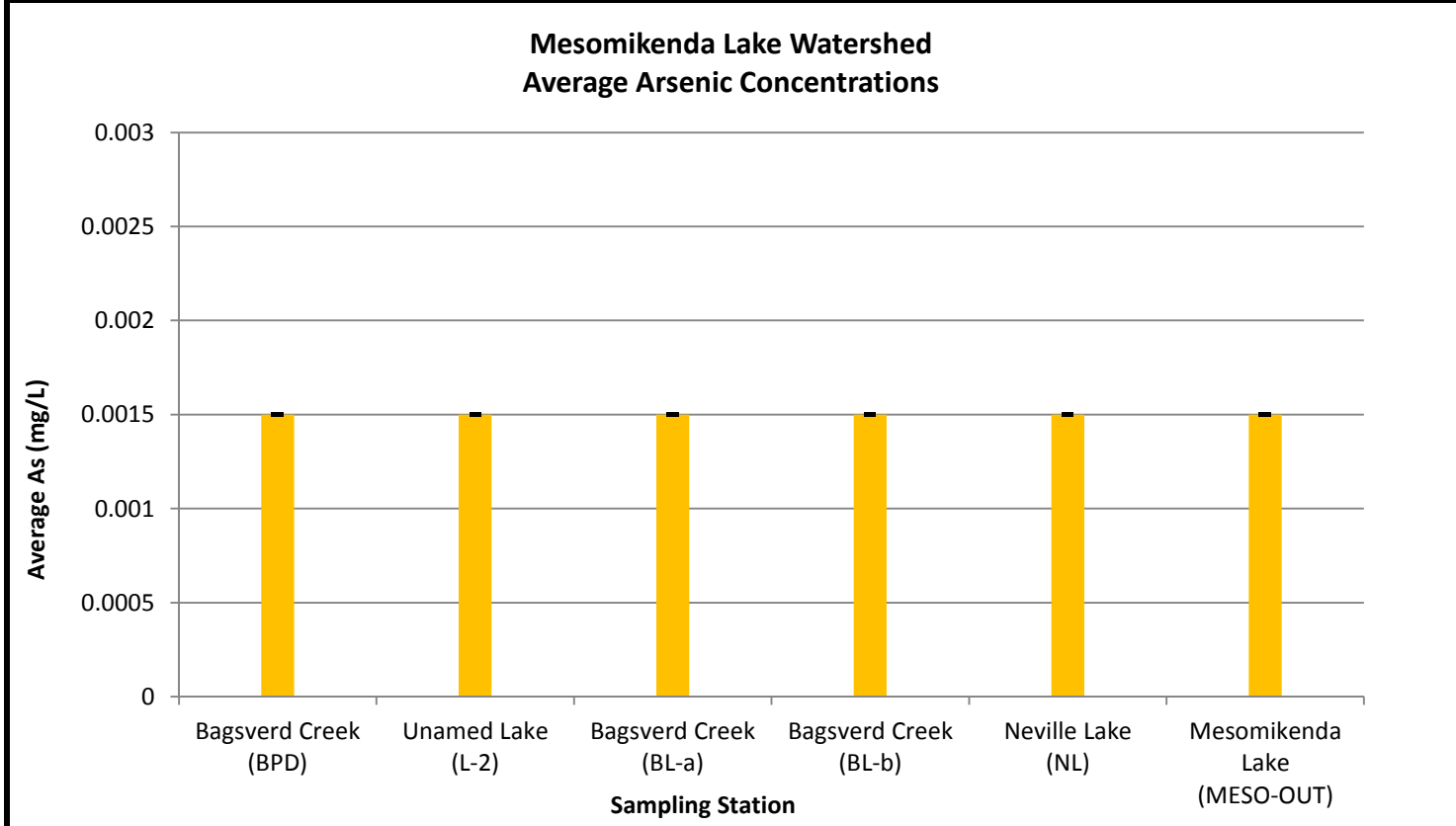

Note: For the purposes of statistical calculations, concentrations below the detection limit were assumed to be one-half the detection limit. Bars depict one standard deviation.

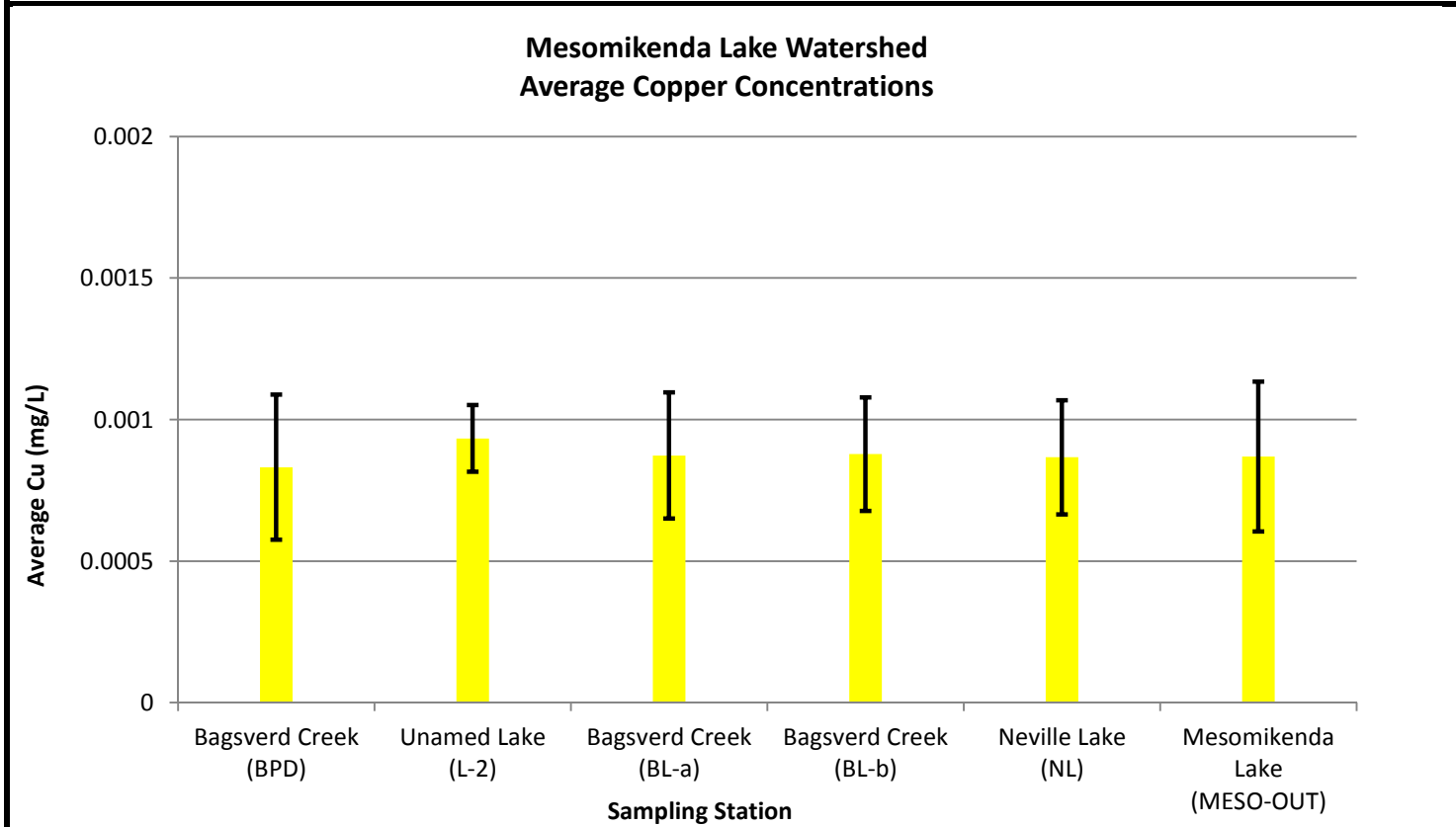

Note: For the purposes of statistical calculations, concentrations below the detection limit were assumed to be one-half the detection limit. Bars depict one standard deviation.

UPDATED BASELINE SURFACE WATER QUALITY DATASET - AVERAGE PARAMETER CONCENTRATIONS, MESOMIKENDA LAKE WATERSHED
CÔTÉ GOLD PROJECT

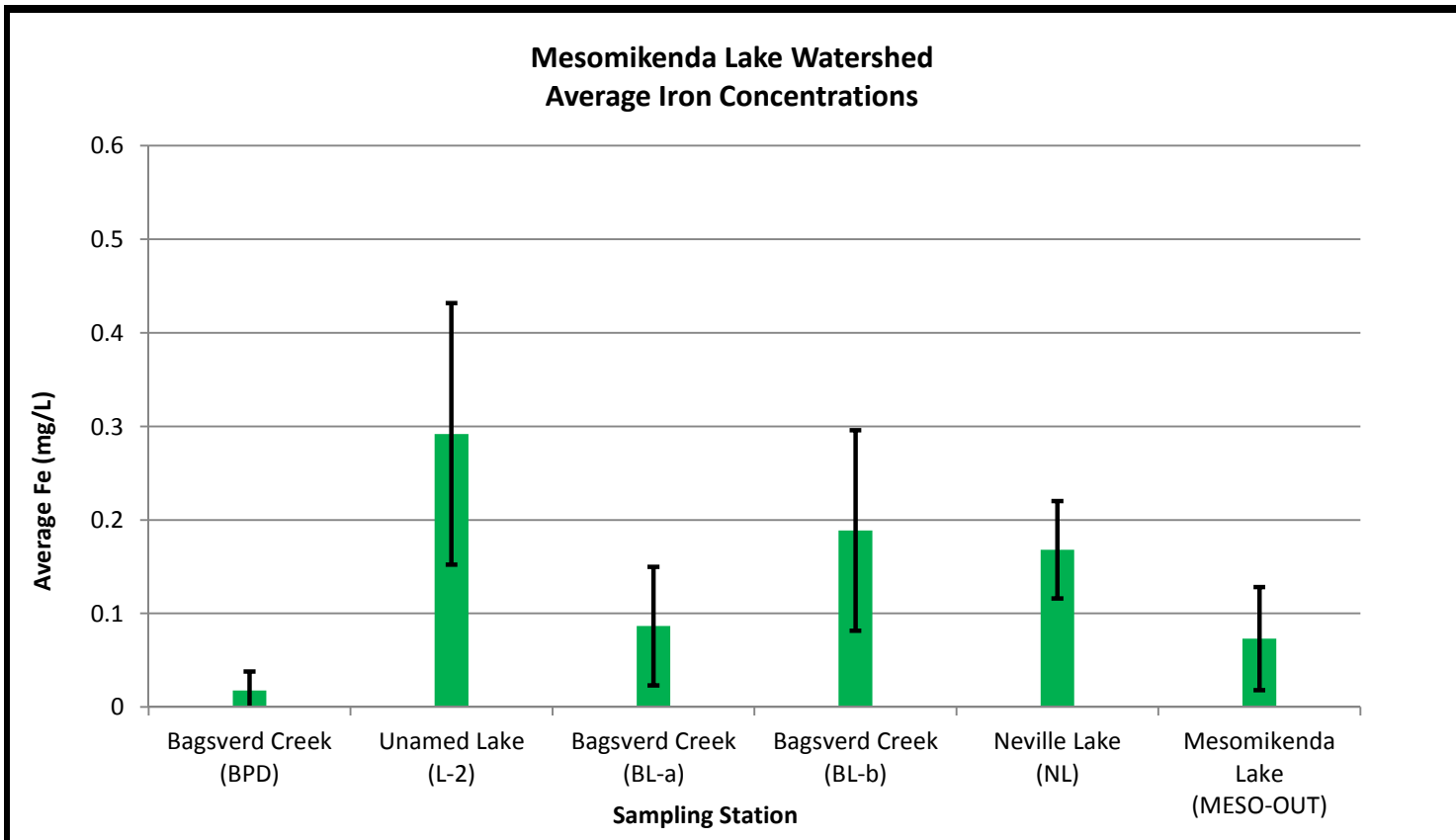

Note: For the purposes of statistical calculations, concentrations below the detection limit were assumed to be one-half the detection limit. Bars depict one standard deviation.

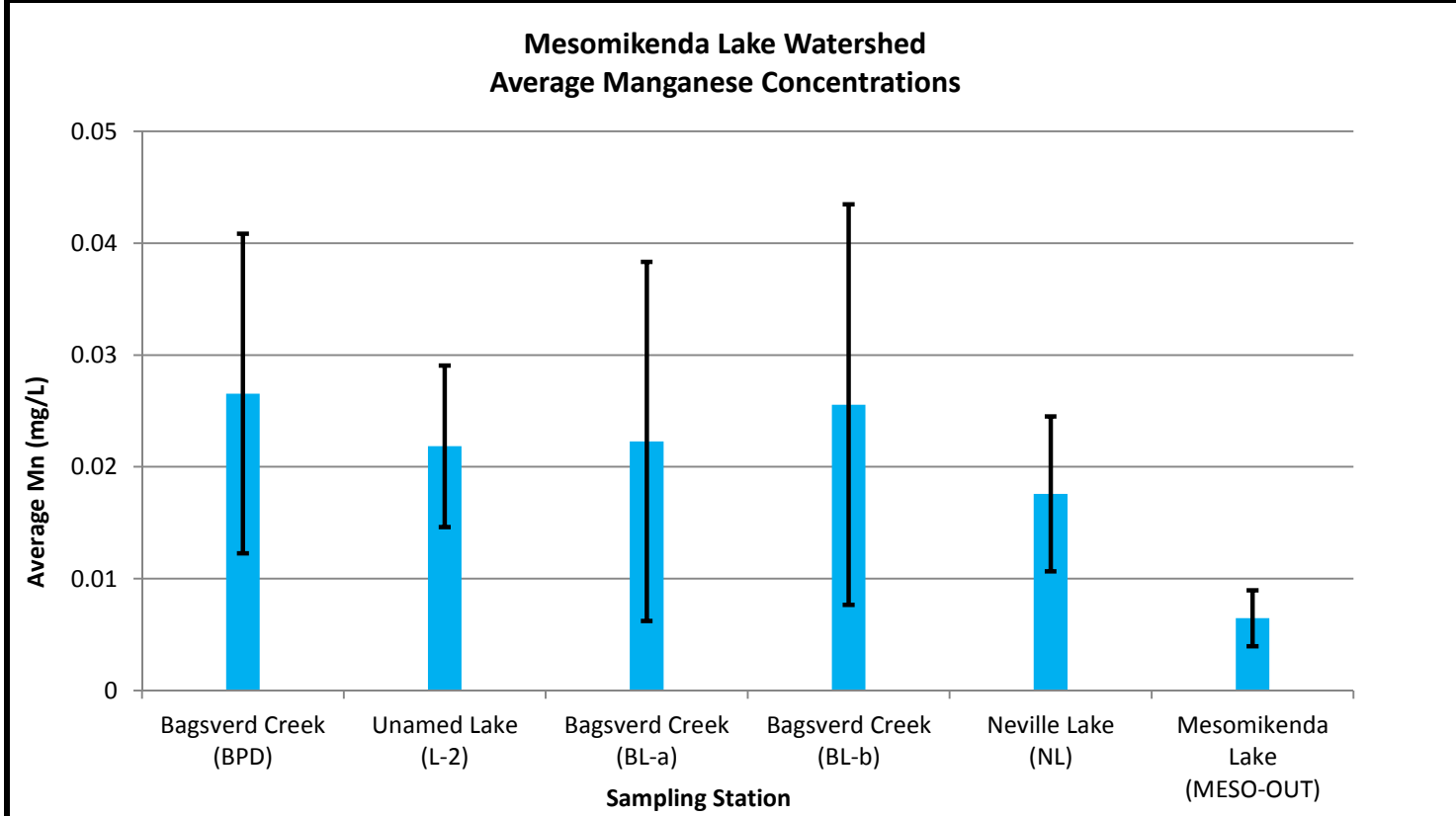

Note: For the purposes of statistical calculations, concentrations below the detection limit were assumed to be one-half the detection limit. Bars depict one standard deviation.

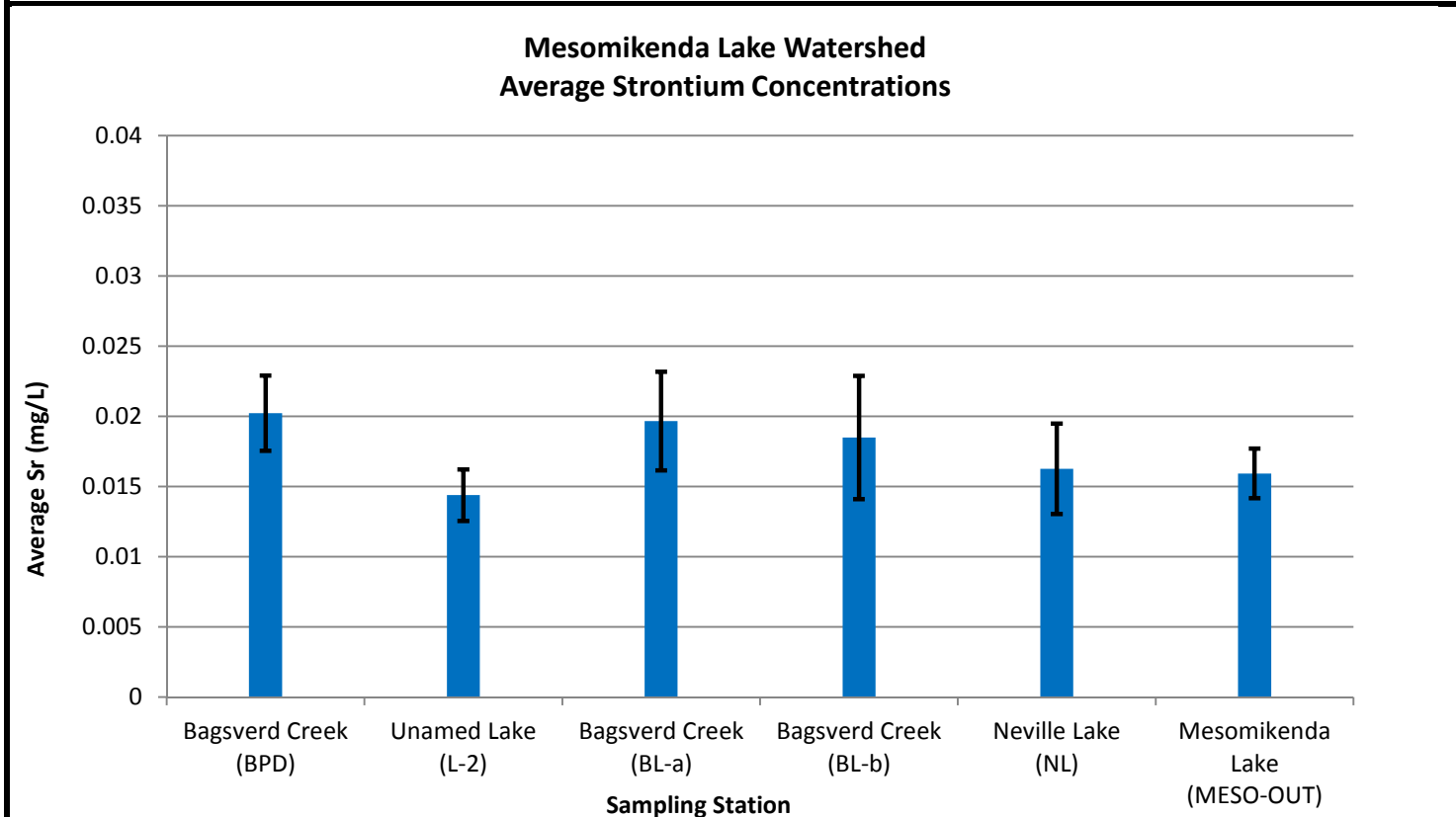

Note: For the purposes of statistical calculations, concentrations below the detection limit were assumed to be one-half the detection limit. Bars depict one standard deviation.

UPDATED BASELINE SURFACE WATER QUALITY DATASET - AVERAGE PARAMETER CONCENTRATIONS, MESOMIKENDA LAKE WATERSHED
CÔTÉ GOLD PROJECT

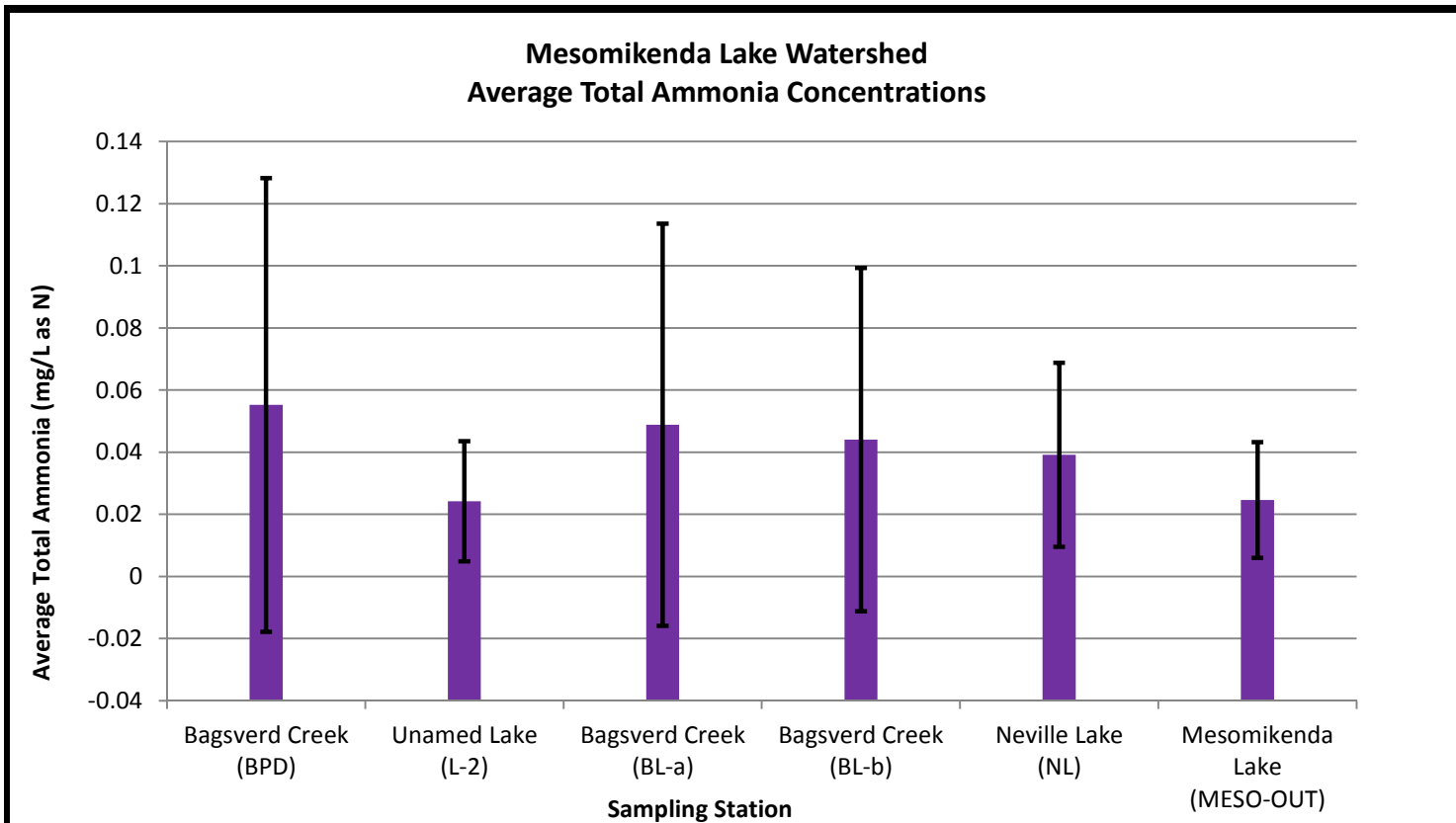

Note: For the purposes of statistical calculations, concentrations below the detection limit were assumed to be one-half the detection limit. Bars depict one standard deviation.

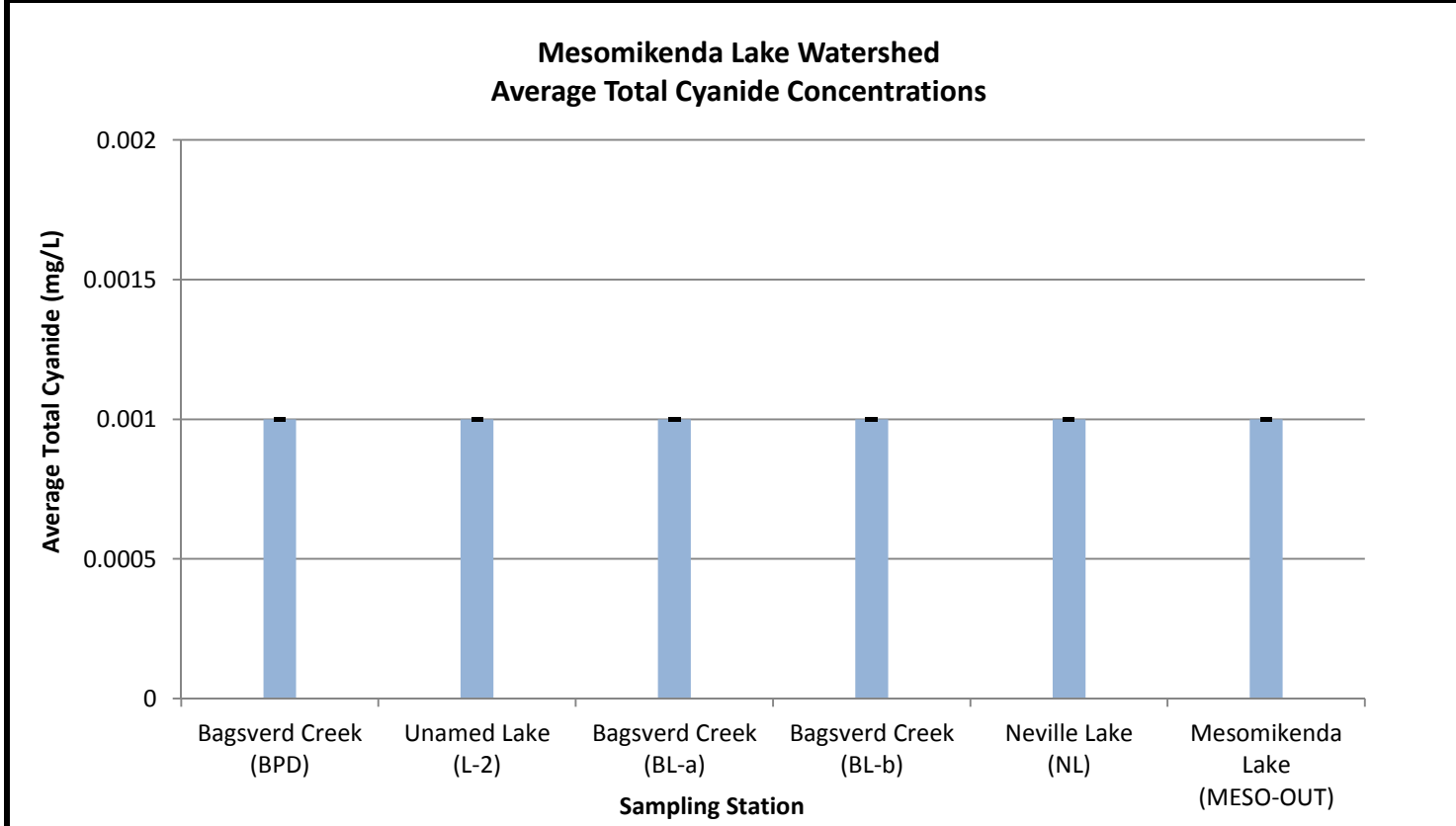

Note: For the purposes of statistical calculations, concentrations below the detection limit were assumed to be one-half the detection limit. Bars depict one standard deviation.

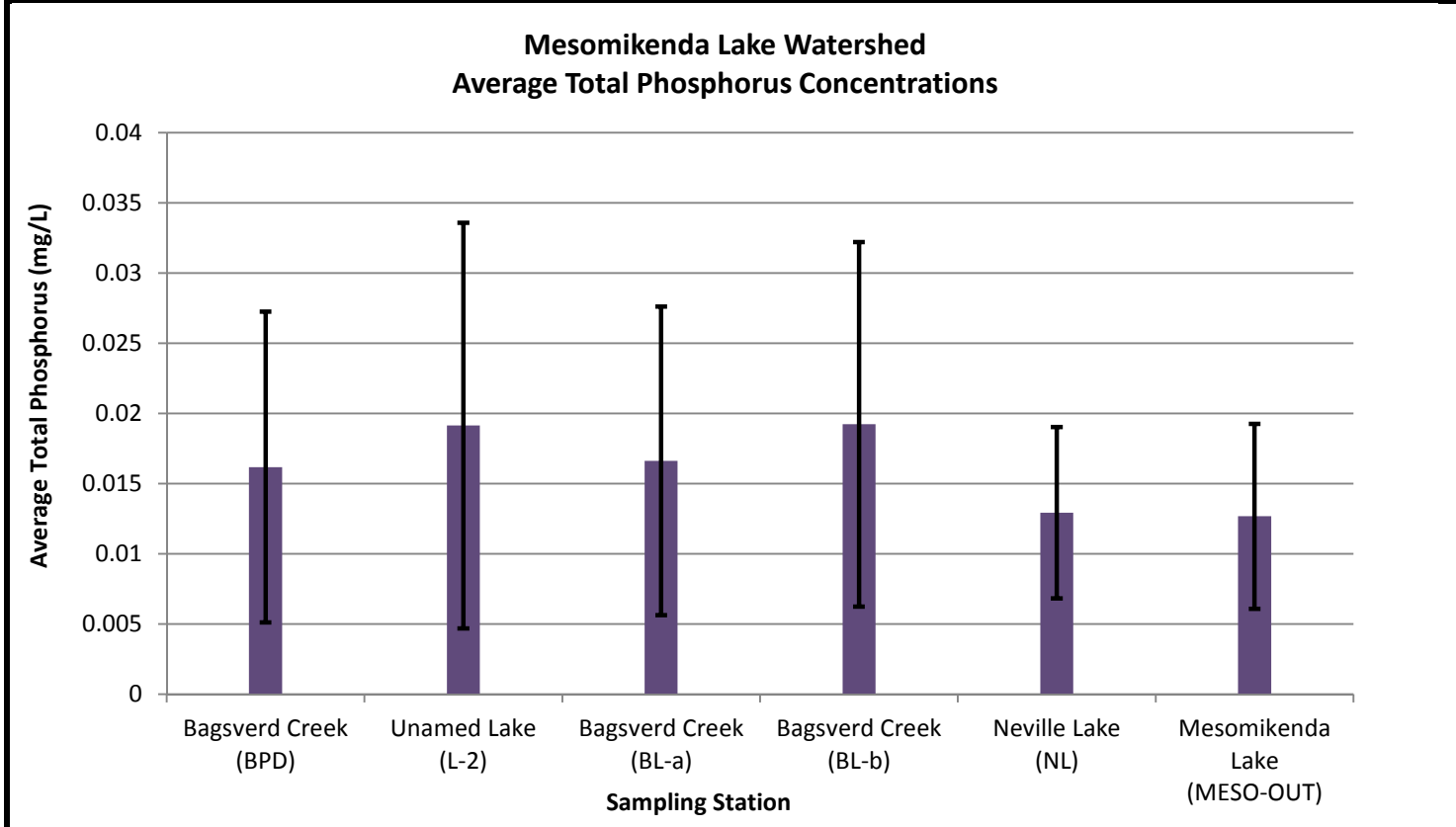

Note: For the purposes of statistical calculations, concentrations below the detection limit were assumed to be one-half the detection limit. Bars depict one standard deviation.

UPDATED BASELINE SURFACE WATER QUALITY DATASET - AVERAGE PARAMETER CONCENTRATIONS, MESOMIKENDA LAKE WATERSHED
CÔTÉ GOLD PROJECT

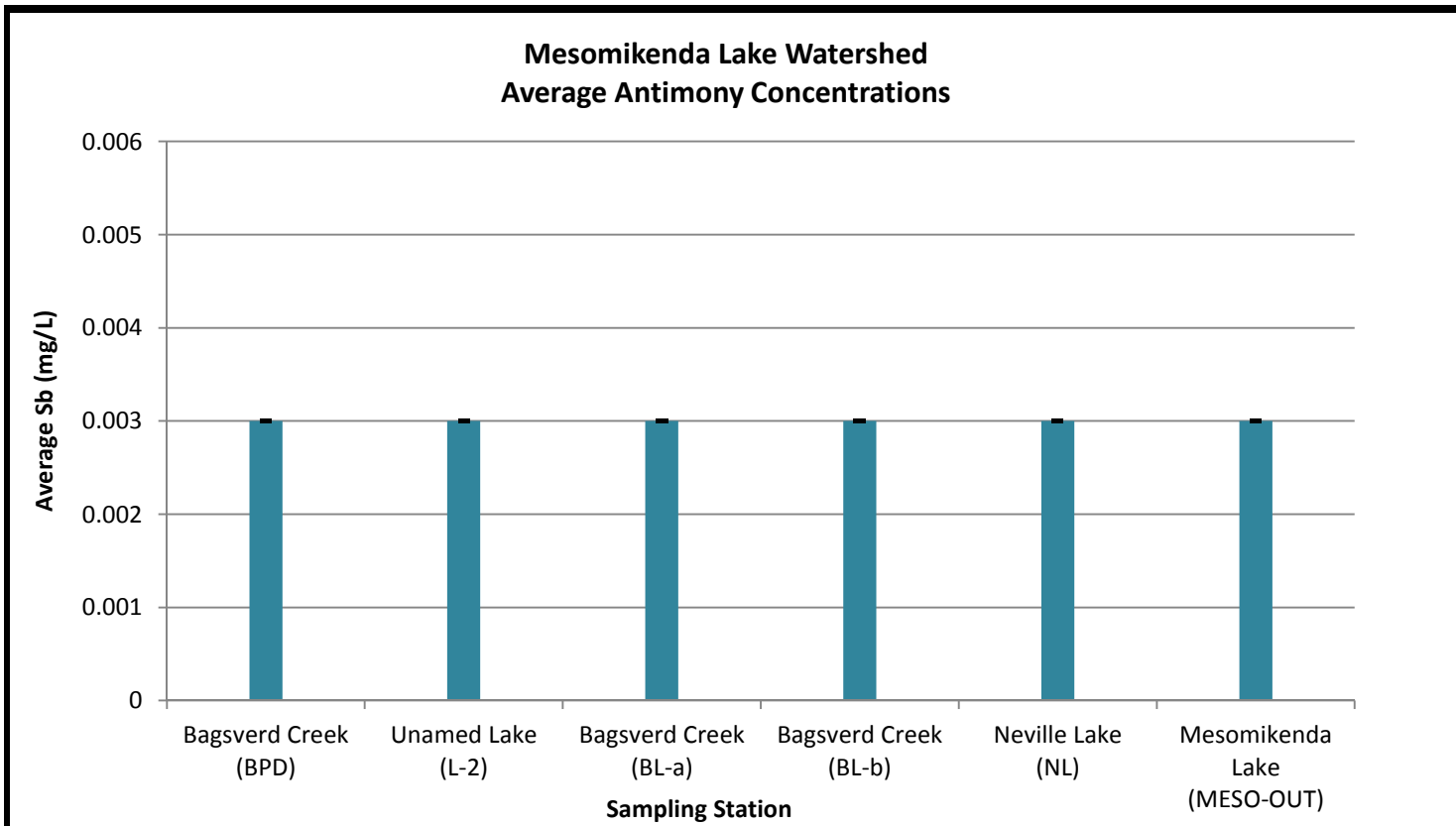

Note: For the purposes of statistical calculations, concentrations below the detection limit were assumed to be one-half the detection limit. Bars depict one standard deviation.

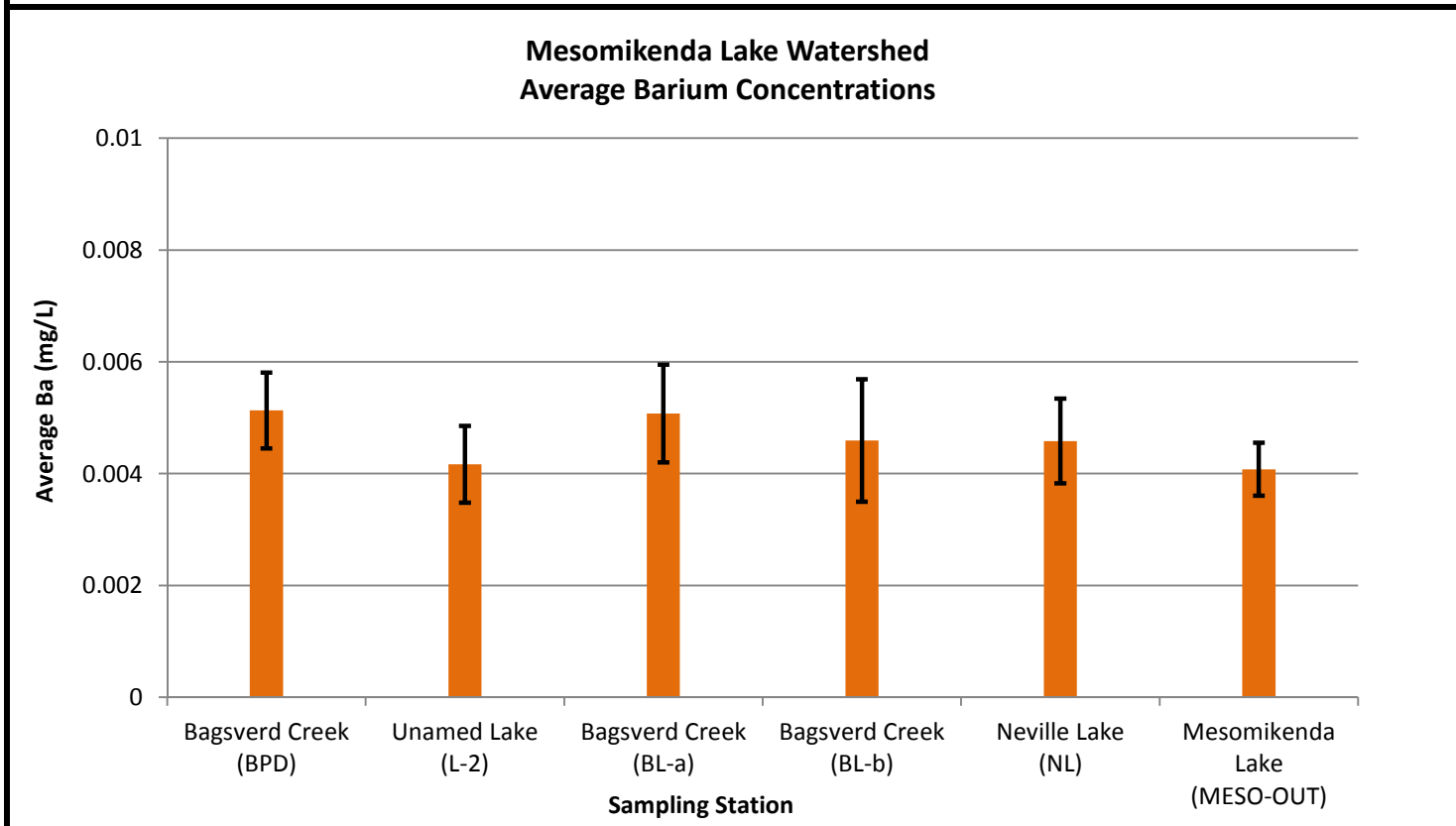

Note: For the purposes of statistical calculations, concentrations below the detection limit were assumed to be one-half the detection limit. Bars depict one standard deviation.

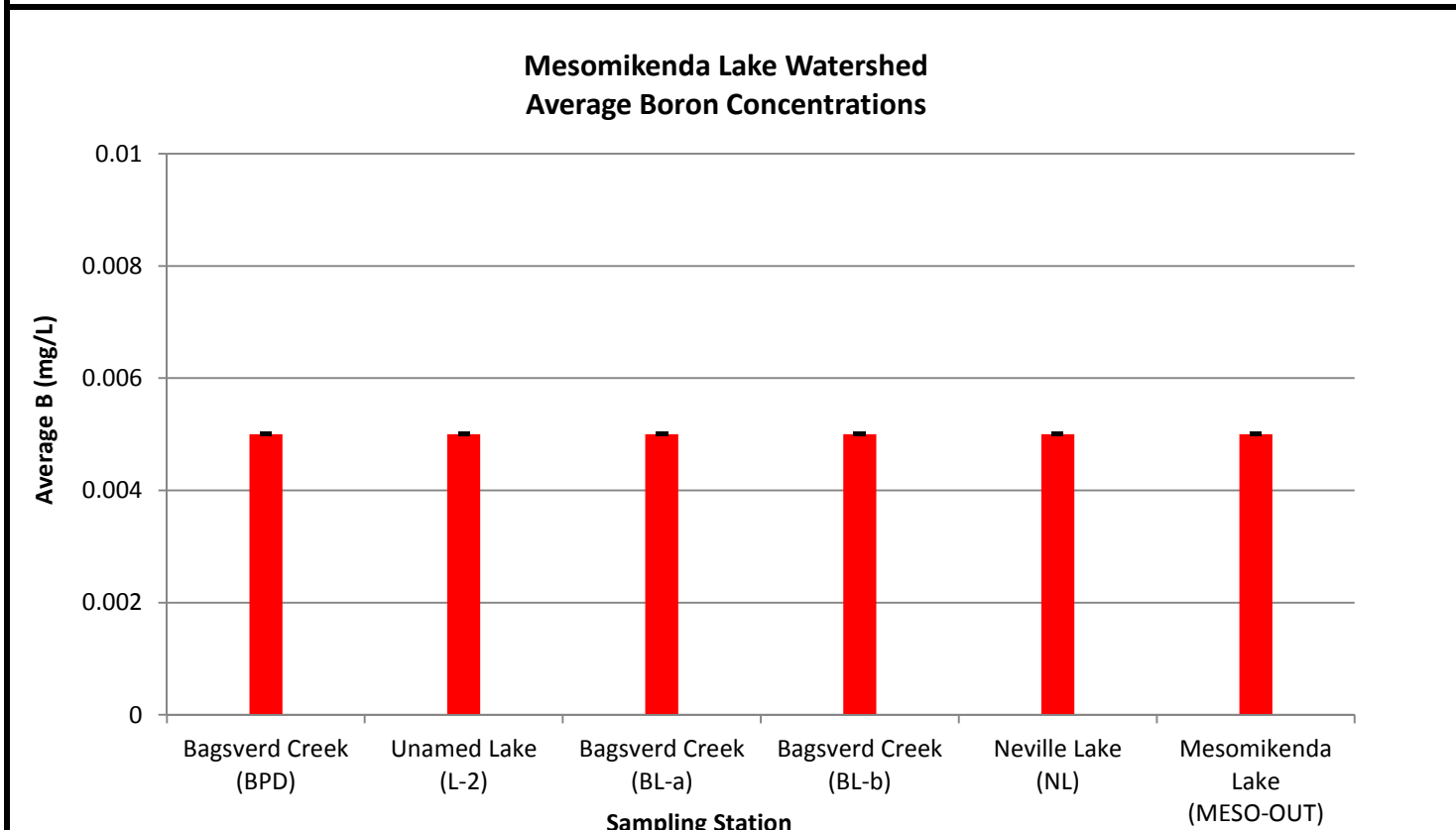

Note: For the purposes of statistical calculations, concentrations below the detection limit were assumed to be one-half the detection limit. Bars depict one standard deviation.

UPDATED BASELINE SURFACE WATER QUALITY DATASET - AVERAGE PARAMETER CONCENTRATIONS, MESOMIKENDA LAKE WATERSHED
CÔTÉ GOLD PROJECT

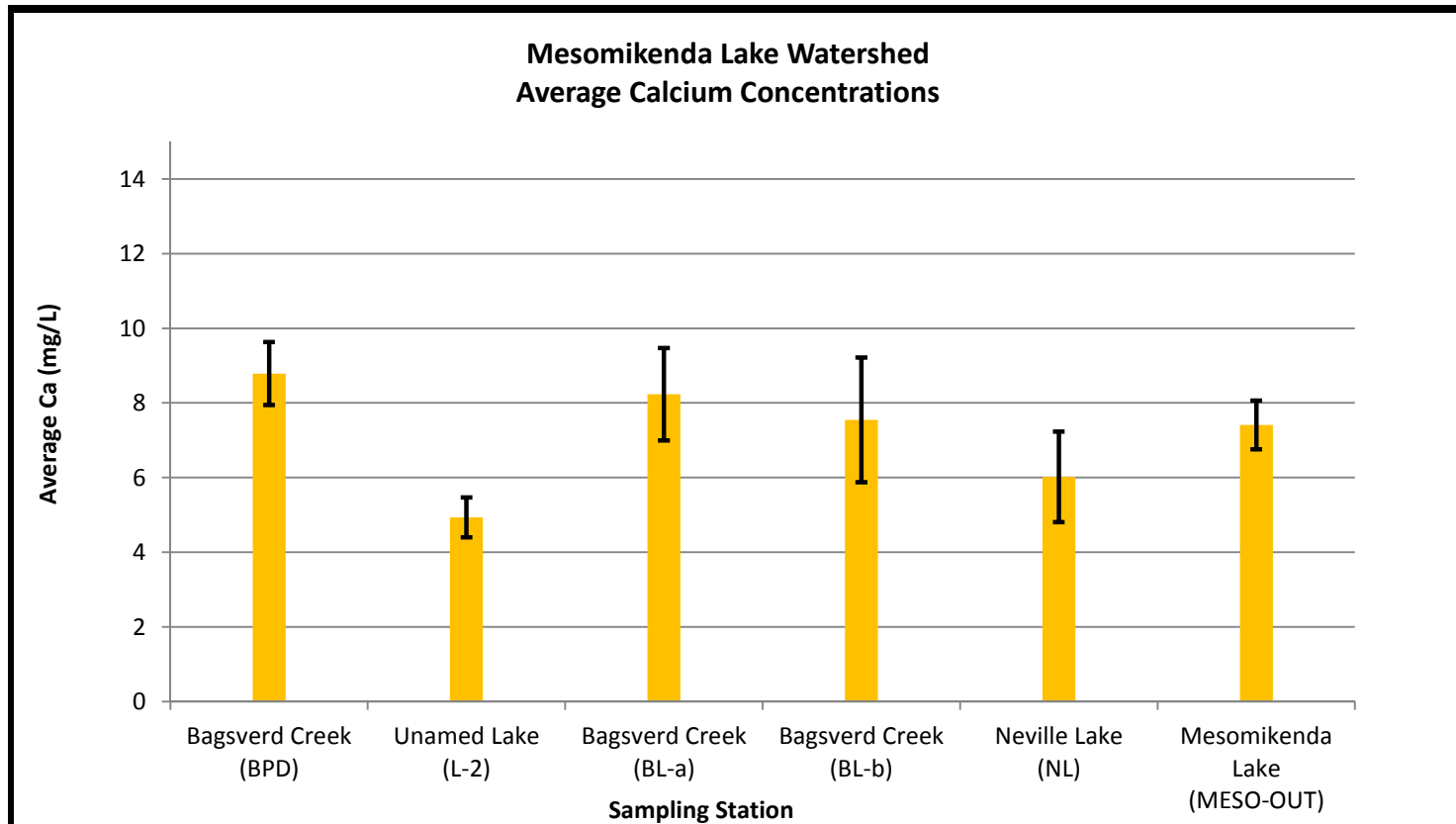

Note: For the purposes of statistical calculations, concentrations below the detection limit were assumed to be one-half the detection limit. Bars depict one standard deviation.

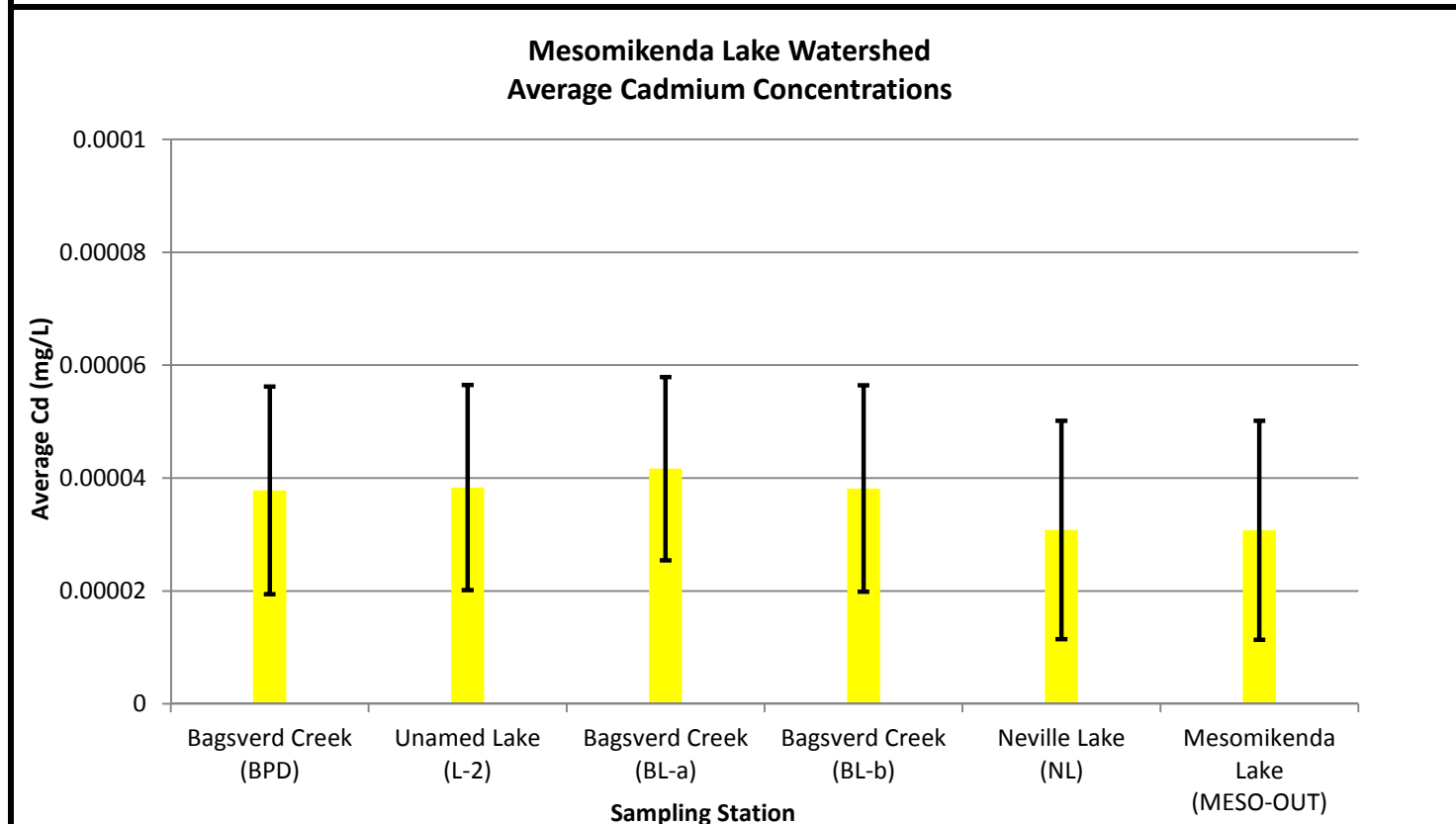

Note: For the purposes of statistical calculations, concentrations below the detection limit were assumed to be one-half the detection limit. Bars depict one standard deviation.

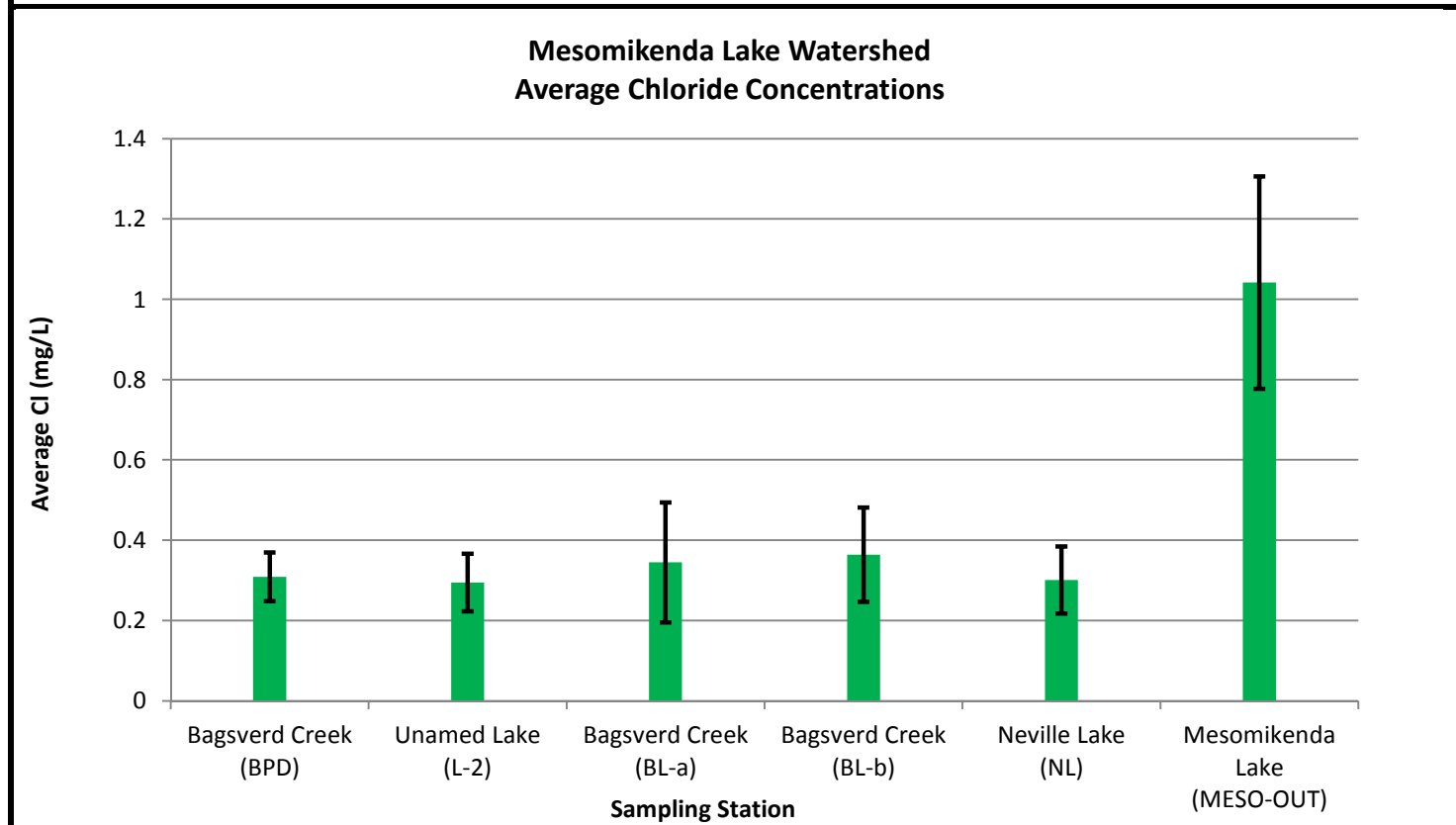

Note: For the purposes of statistical calculations, concentrations below the detection limit were assumed to be one-half the detection limit. Bars depict one standard deviation.

UPDATED BASELINE SURFACE WATER QUALITY DATASET - AVERAGE PARAMETER CONCENTRATIONS, MESOMIKENDA LAKE WATERSHED
CÔTÉ GOLD PROJECT

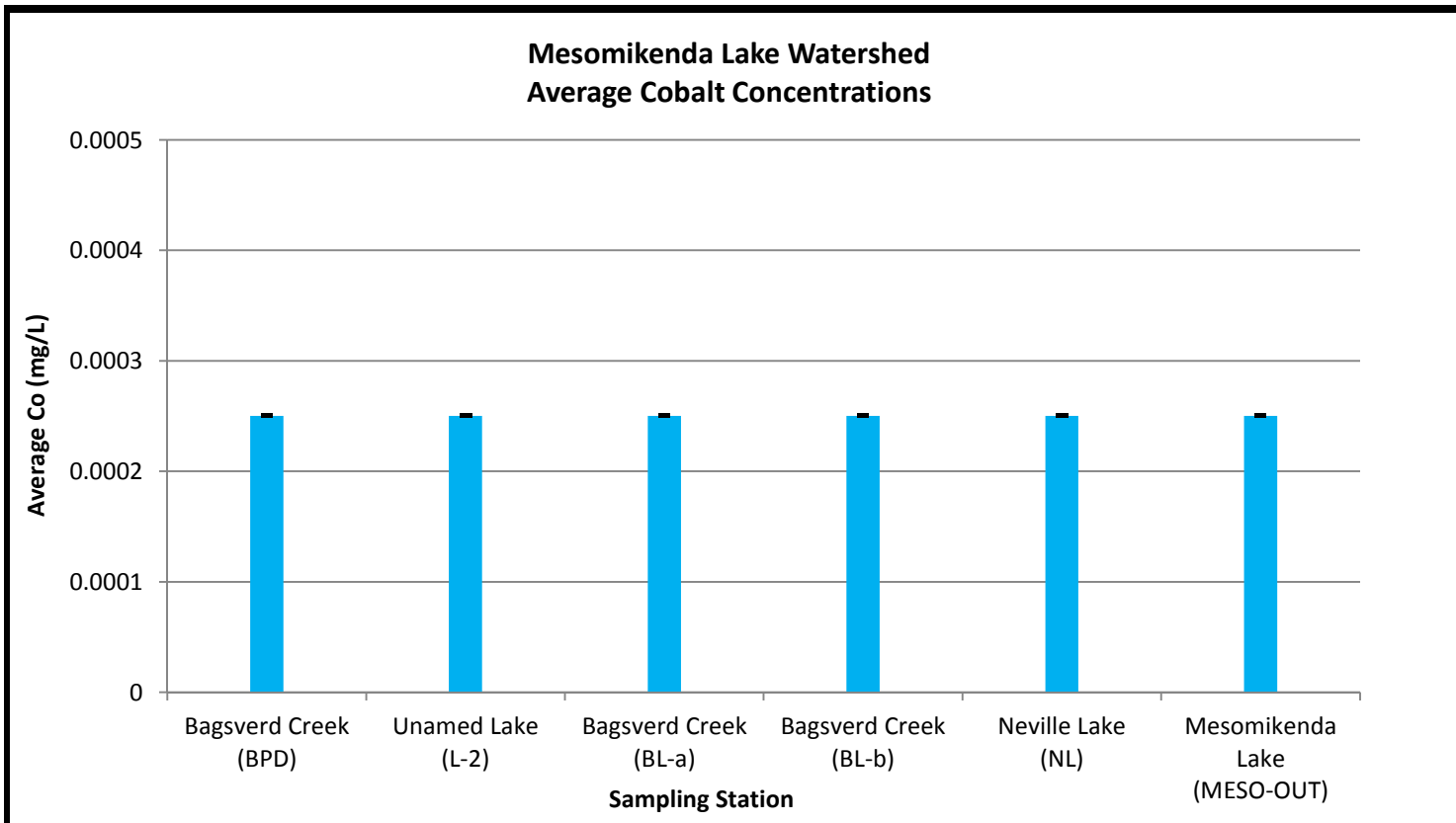

Note: For the purposes of statistical calculations, concentrations below the detection limit were assumed to be one-half the detection limit. Bars depict one standard deviation.

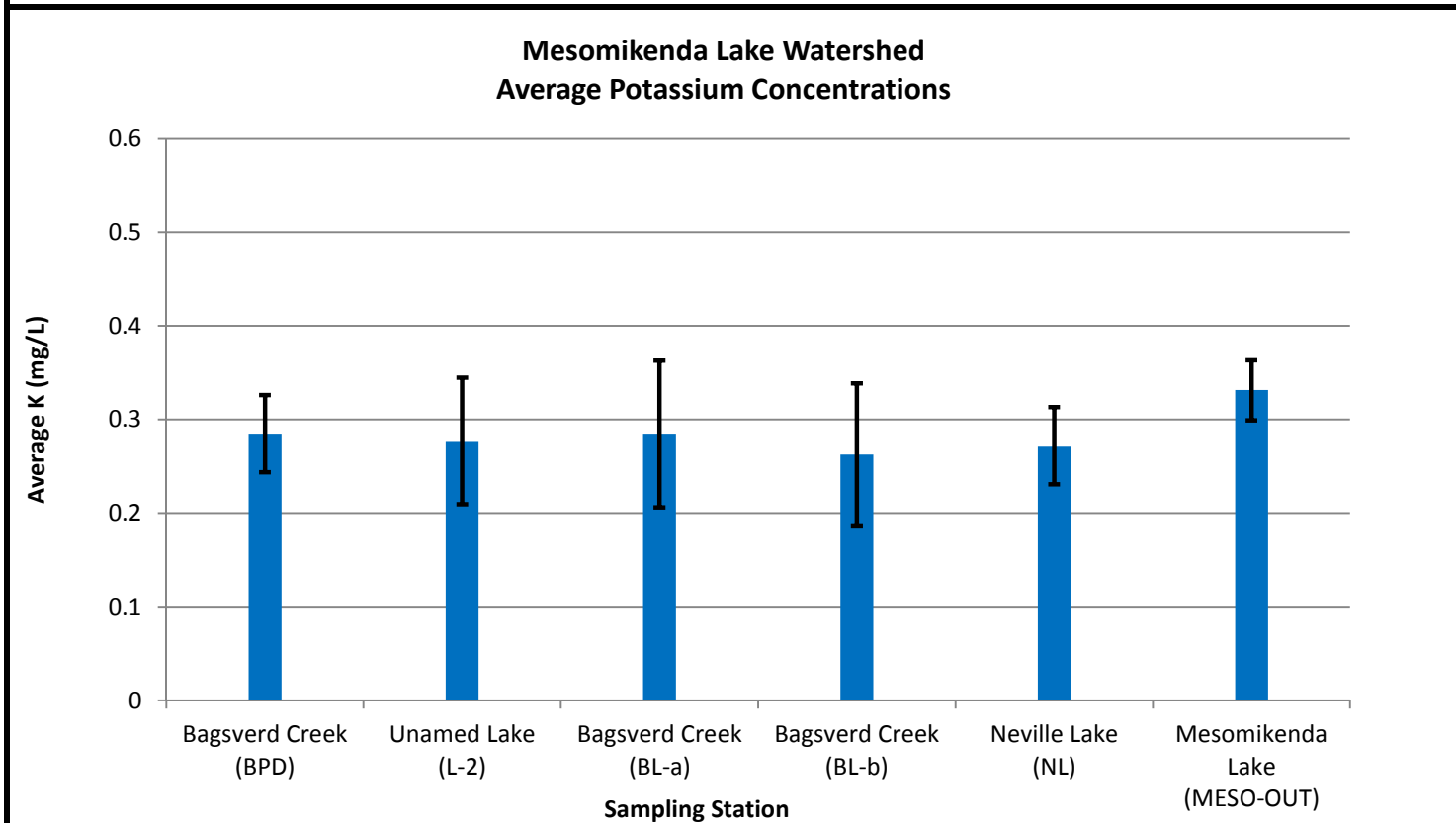

Note: For the purposes of statistical calculations, concentrations below the detection limit were assumed to be one-half the detection limit. Bars depict one standard deviation.

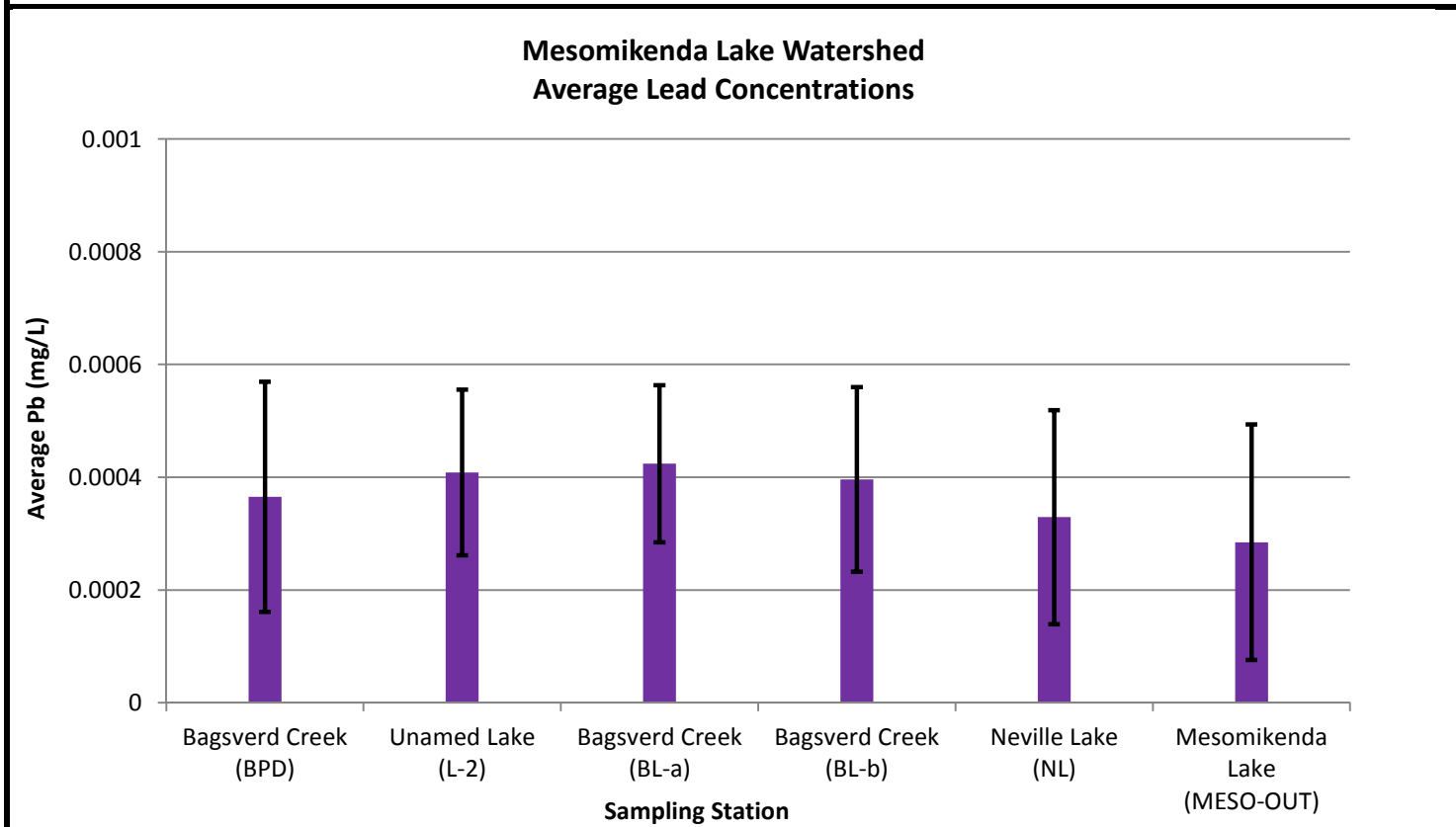

Note: For the purposes of statistical calculations, concentrations below the detection limit were assumed to be one-half the detection limit. Bars depict one standard deviation.

UPDATED BASELINE SURFACE WATER QUALITY DATASET - AVERAGE PARAMETER CONCENTRATIONS, MESOMIKENDA LAKE WATERSHED
CÔTÉ GOLD PROJECT

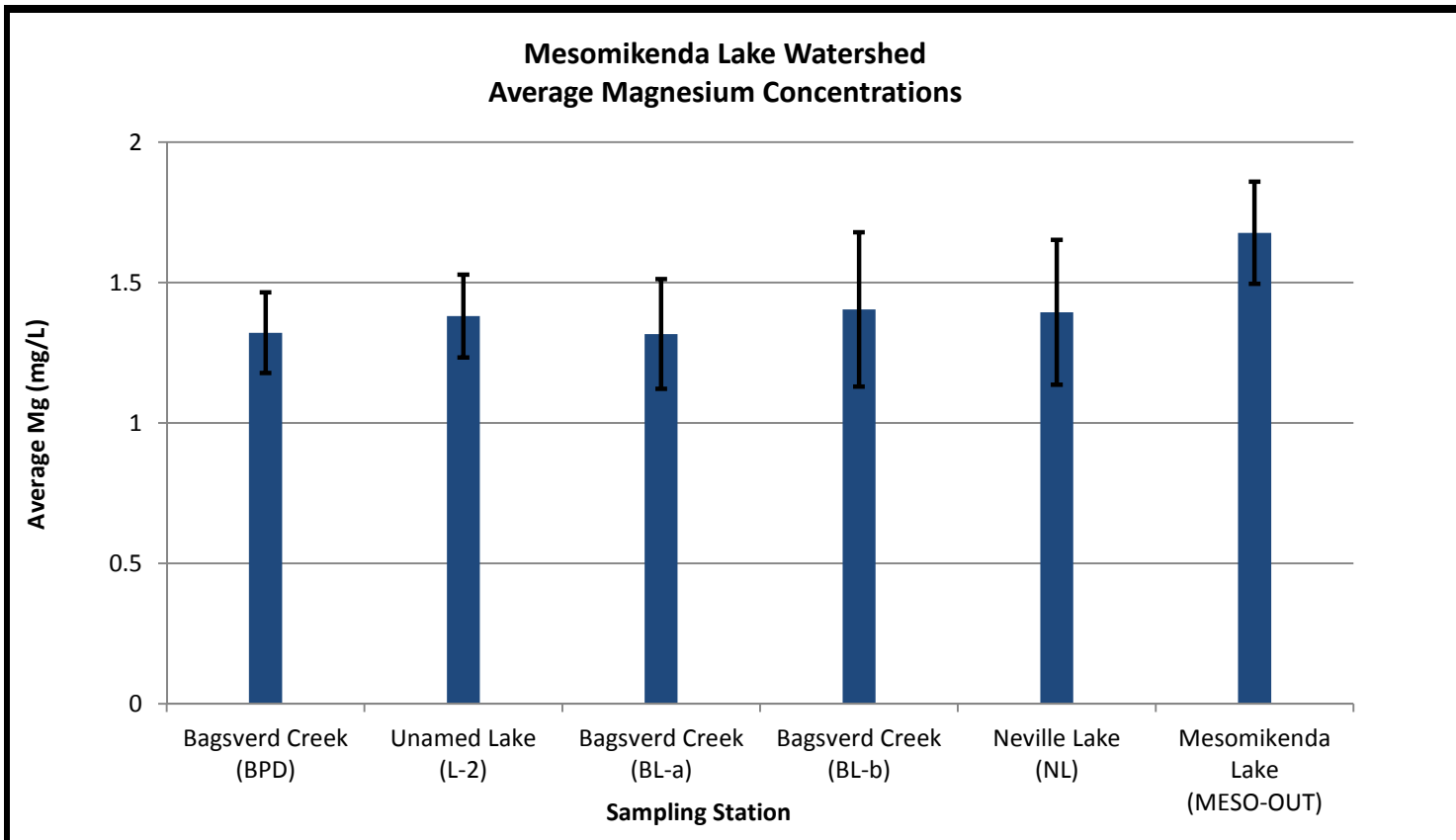

Note: For the purposes of statistical calculations, concentrations below the detection limit were assumed to be one-half the detection limit. Bars depict one standard deviation.

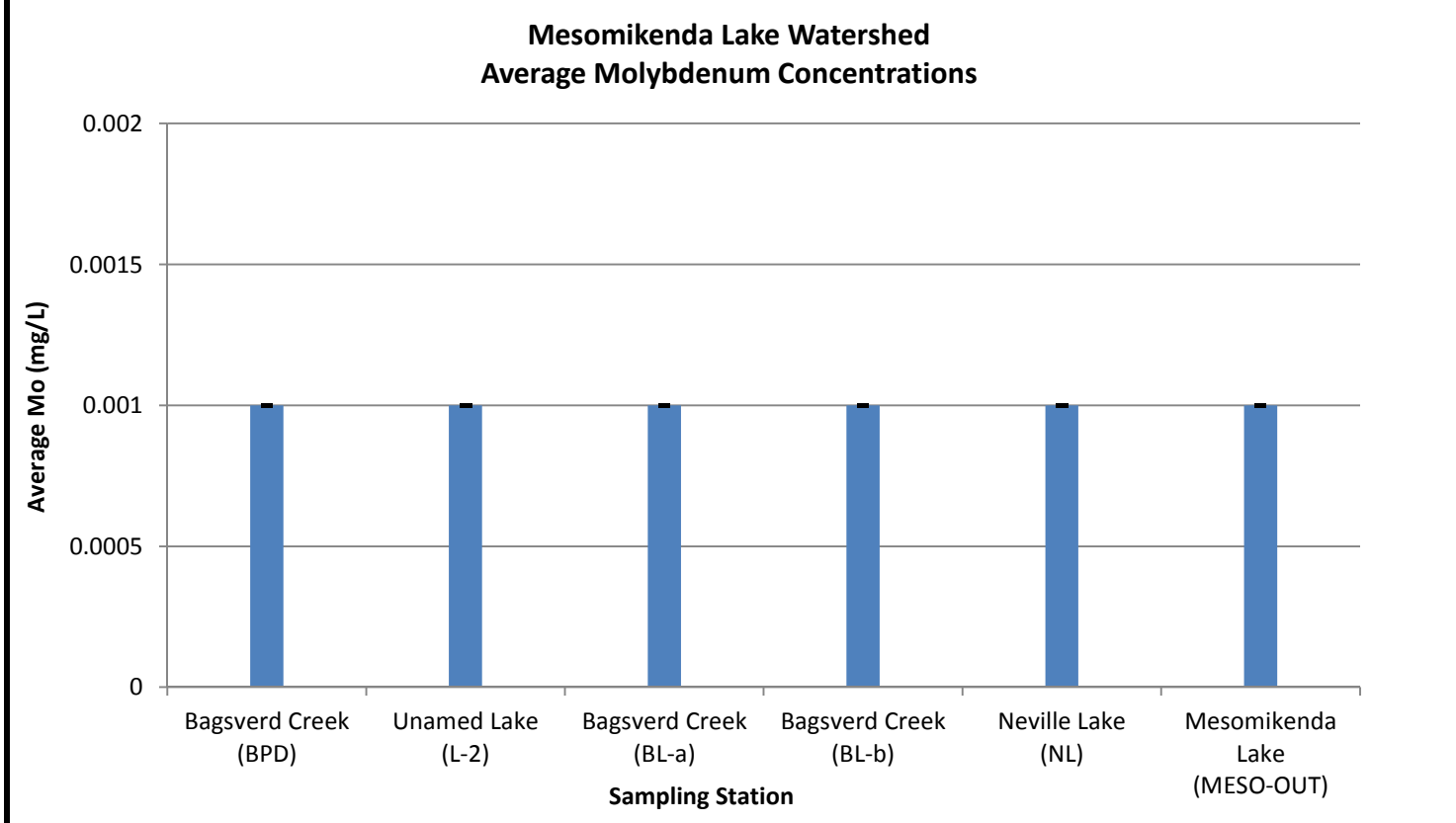

Note: For the purposes of statistical calculations, concentrations below the detection limit were assumed to be one-half the detection limit. Bars depict one standard deviation.

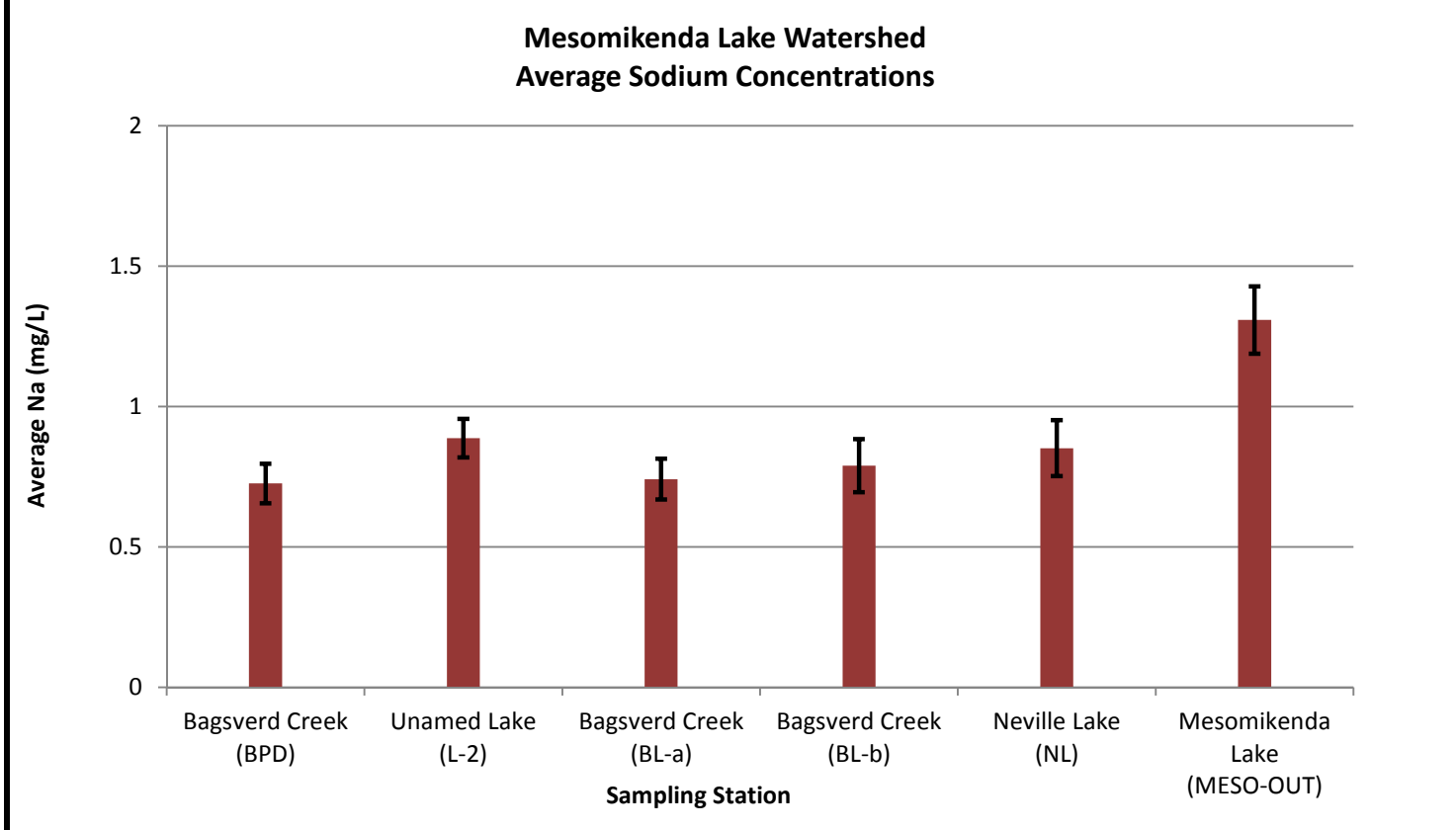

Note: For the purposes of statistical calculations, concentrations below the detection limit were assumed to be one-half the detection limit. Bars depict one standard deviation.

UPDATED BASELINE SURFACE WATER QUALITY DATASET - AVERAGE PARAMETER CONCENTRATIONS, MESOMIKENDA LAKE WATERSHED
CÔTÉ GOLD PROJECT

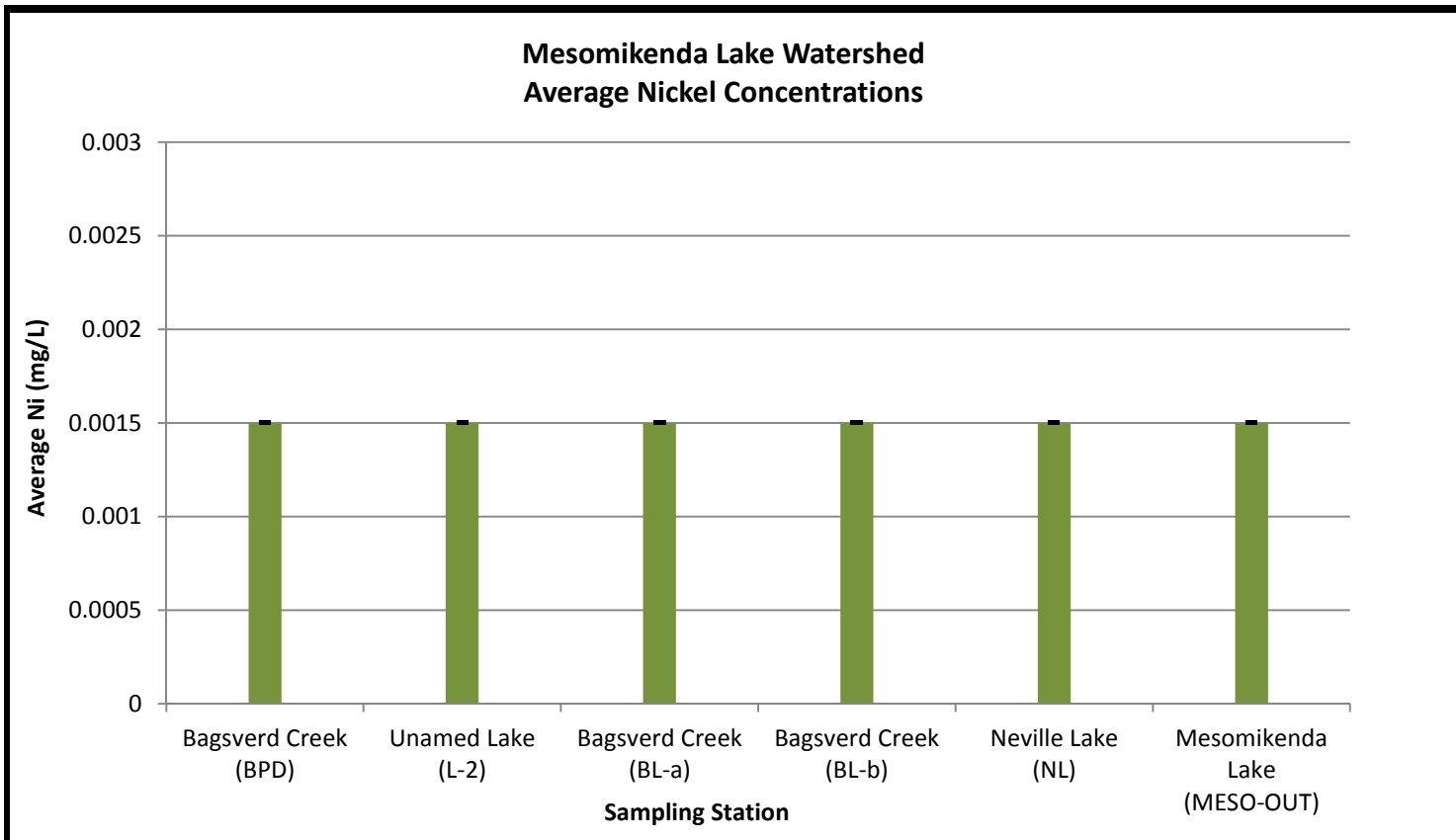

Note: For the purposes of statistical calculations, concentrations below the detection limit were assumed to be one-half the detection limit. Bars depict one standard deviation.

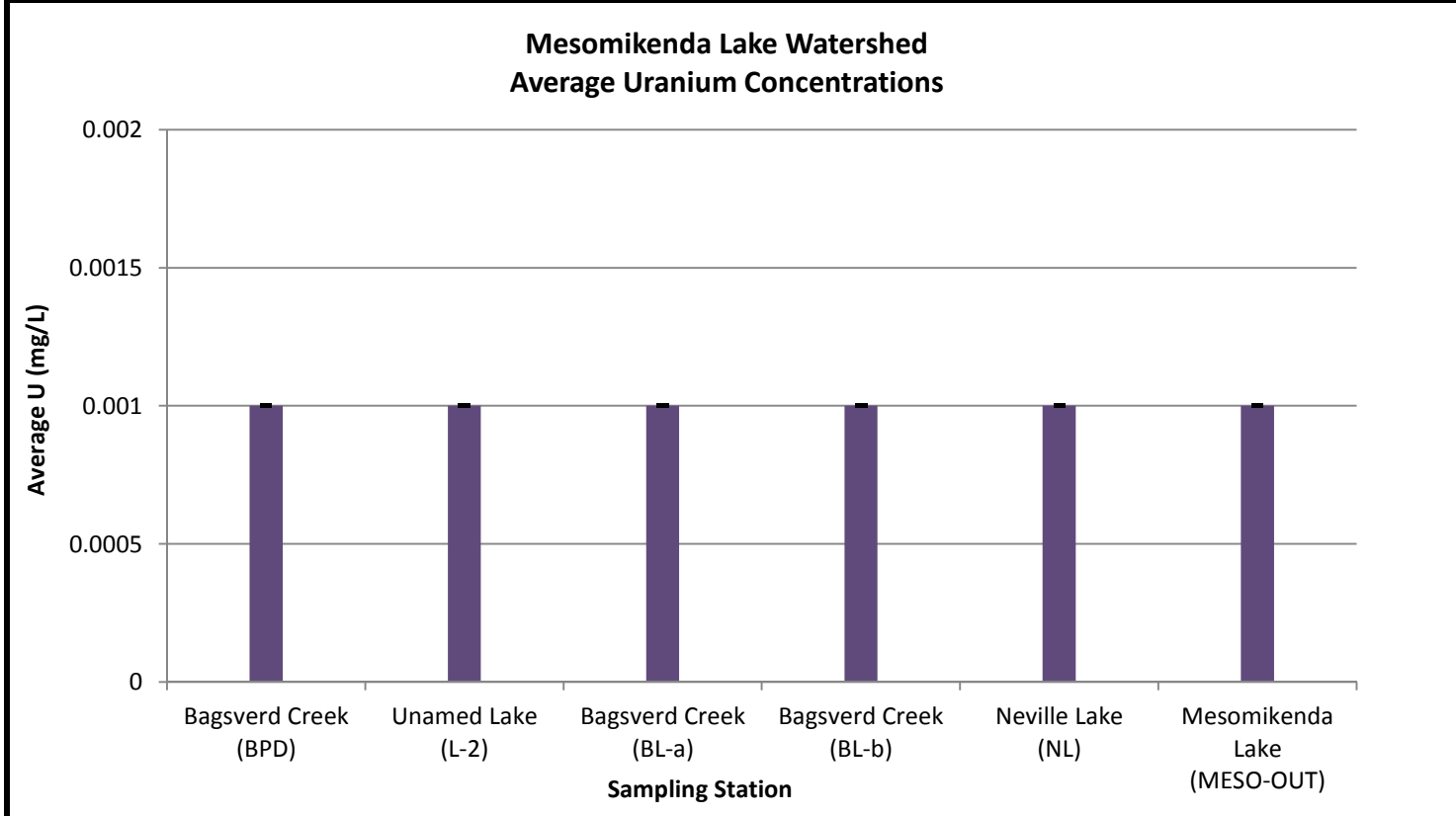

Note: For the purposes of statistical calculations, concentrations below the detection limit were assumed to be one-half the detection limit. Bars depict one standard deviation.

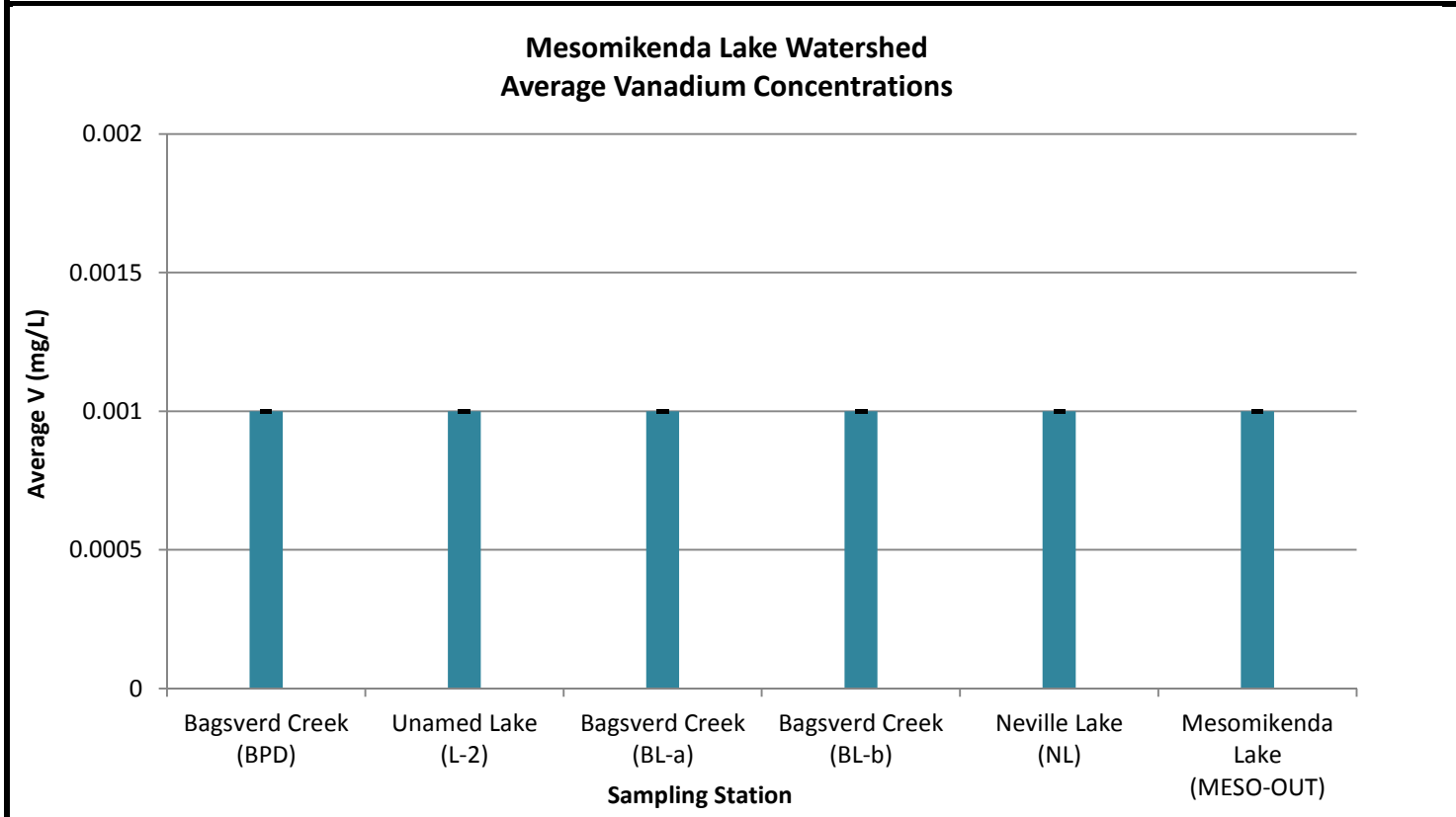

Note: For the purposes of statistical calculations, concentrations below the detection limit were assumed to be one-half the detection limit. Bars depict one standard deviation.

UPDATED BASELINE SURFACE WATER QUALITY DATASET - AVERAGE PARAMETER CONCENTRATIONS, MESOMIKENDA LAKE WATERSHED
CÔTÉ GOLD PROJECT

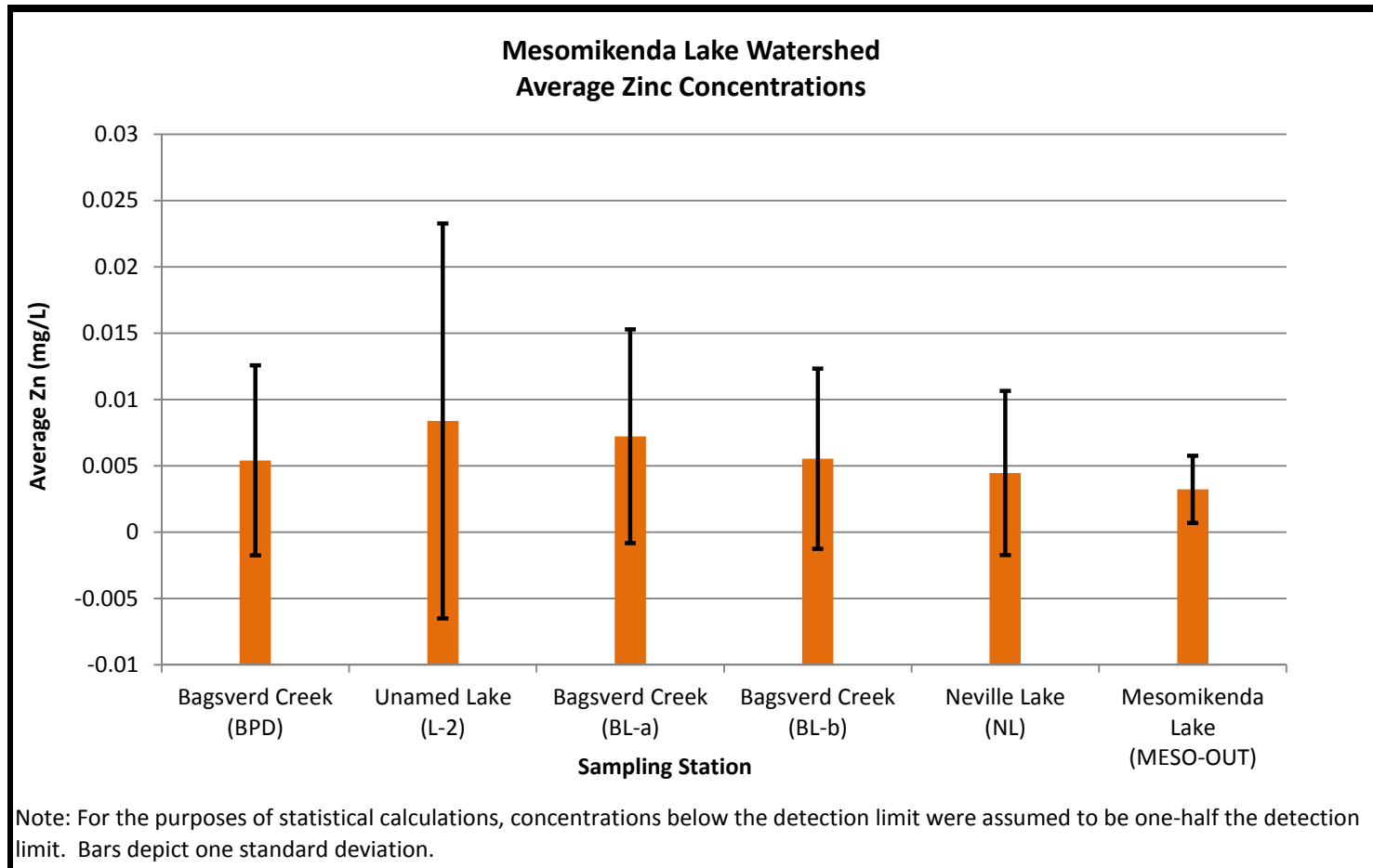

UPDATED BASELINE SURFACE WATER QUALITY DATASET - MONTHLY AVERAGE PARAMETER CONCENTRATIONS
CÔTÉ GOLD PROJECT

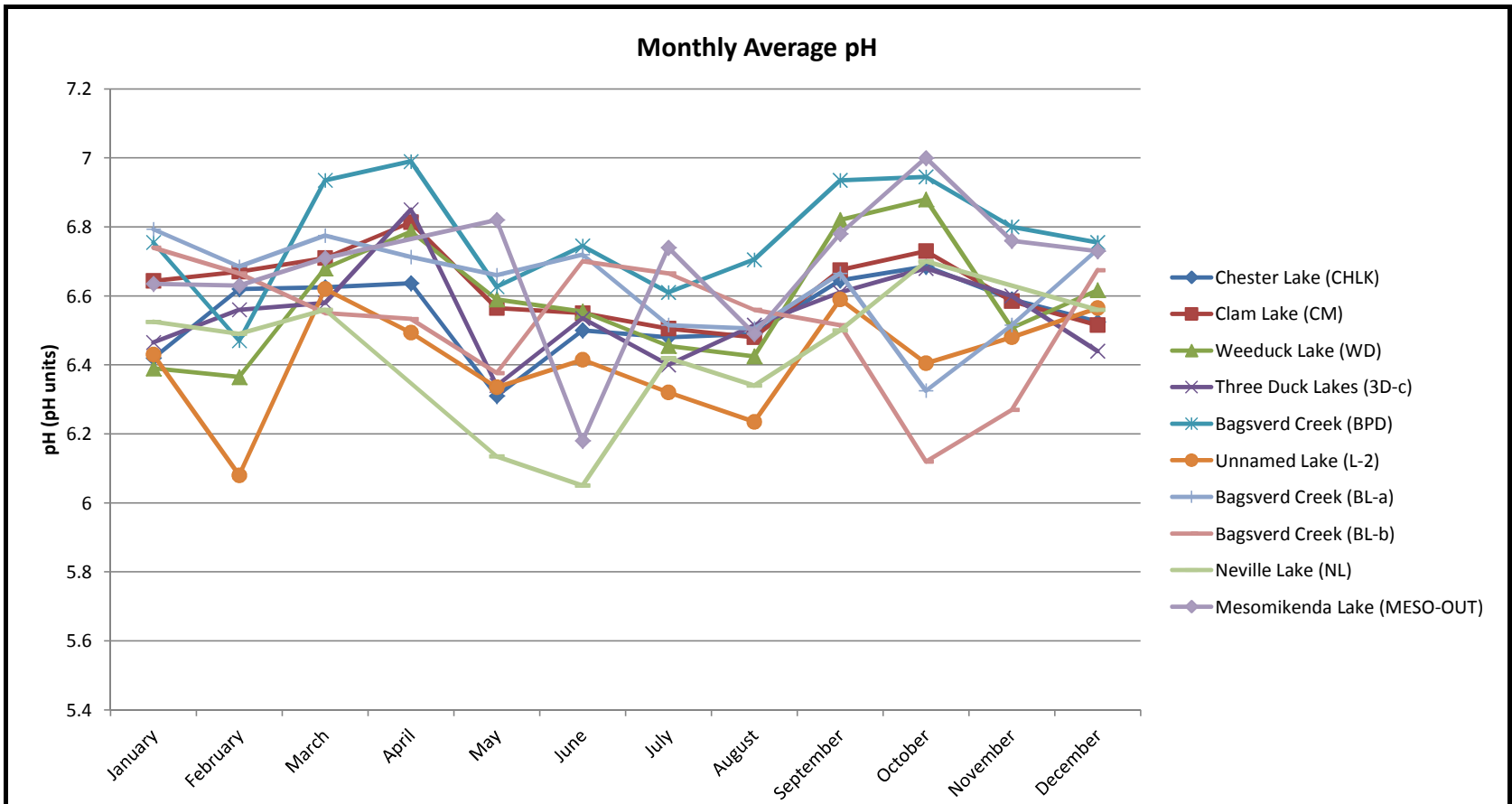

Note: For the purposes of statistical calculations, concentrations below the detection limit were assumed to be one-half the detection limit.

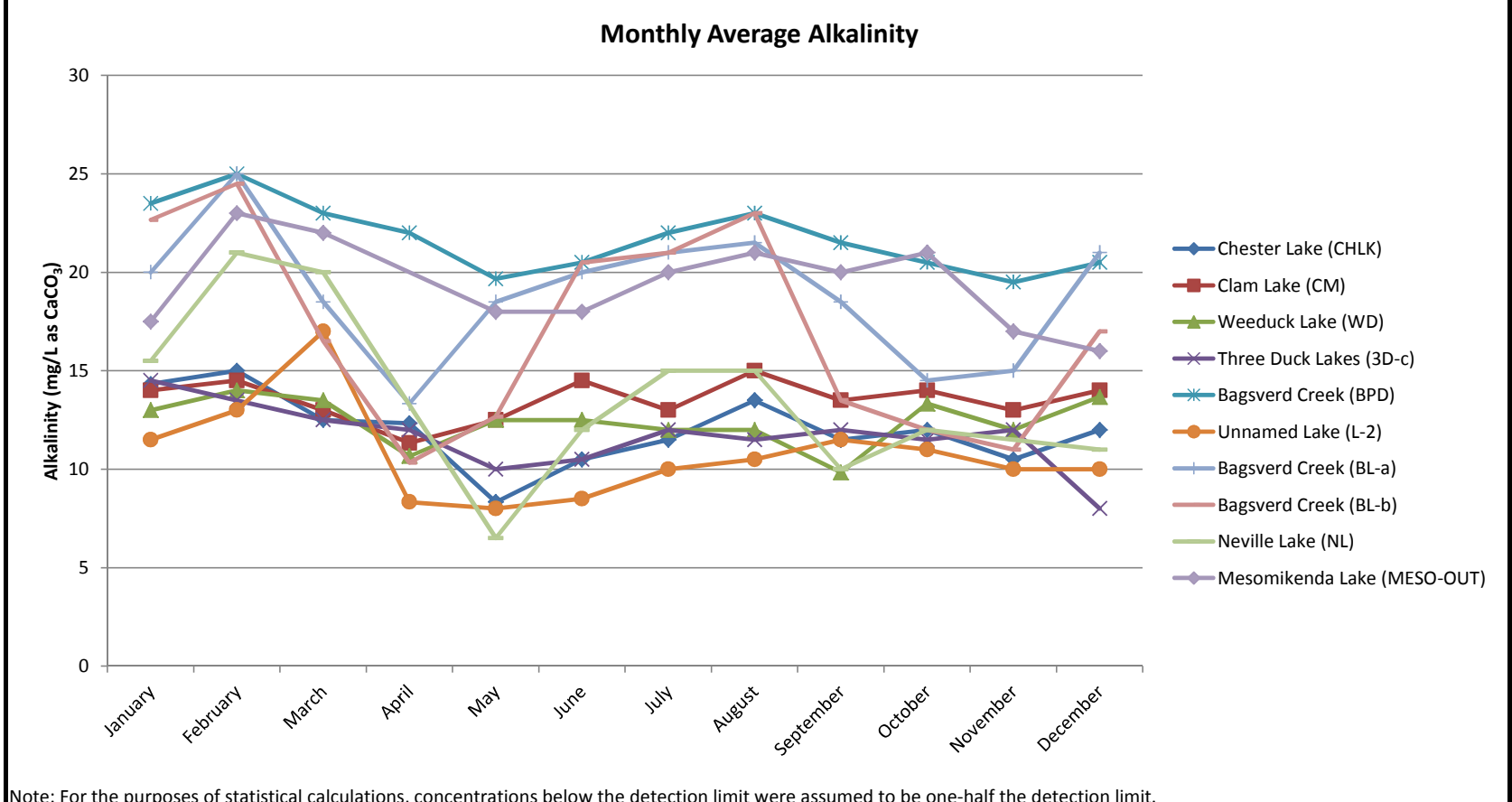

Note: For the purposes of statistical calculations, concentrations below the detection limit were assumed to be one-half the detection limit.

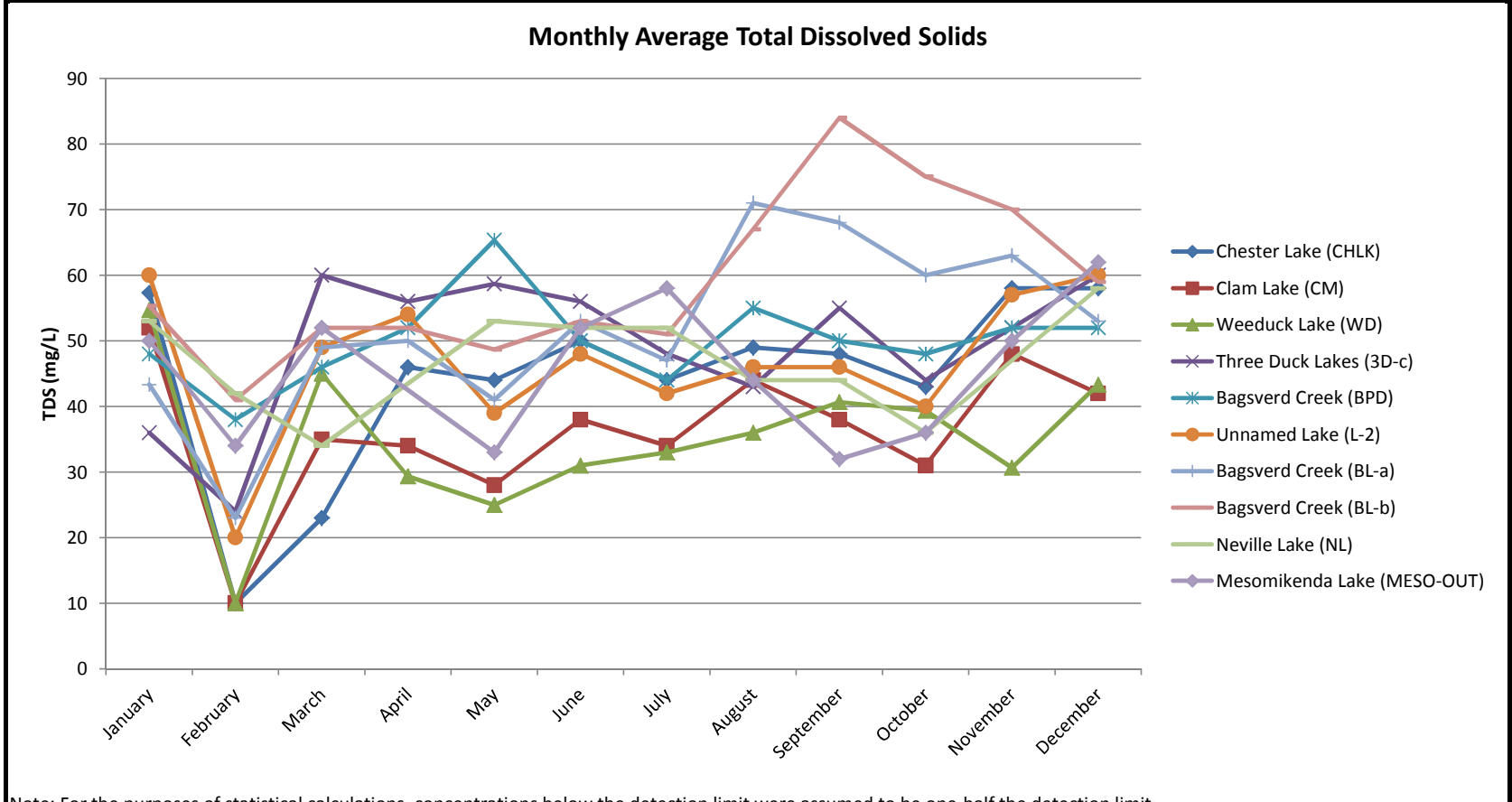

Note: For the purposes of statistical calculations, concentrations below the detection limit were assumed to be one-half the detection limit.

UPDATED BASELINE SURFACE WATER QUALITY DATASET - MONTHLY AVERAGE PARAMETER CONCENTRATIONS
CÔTÉ GOLD PROJECT

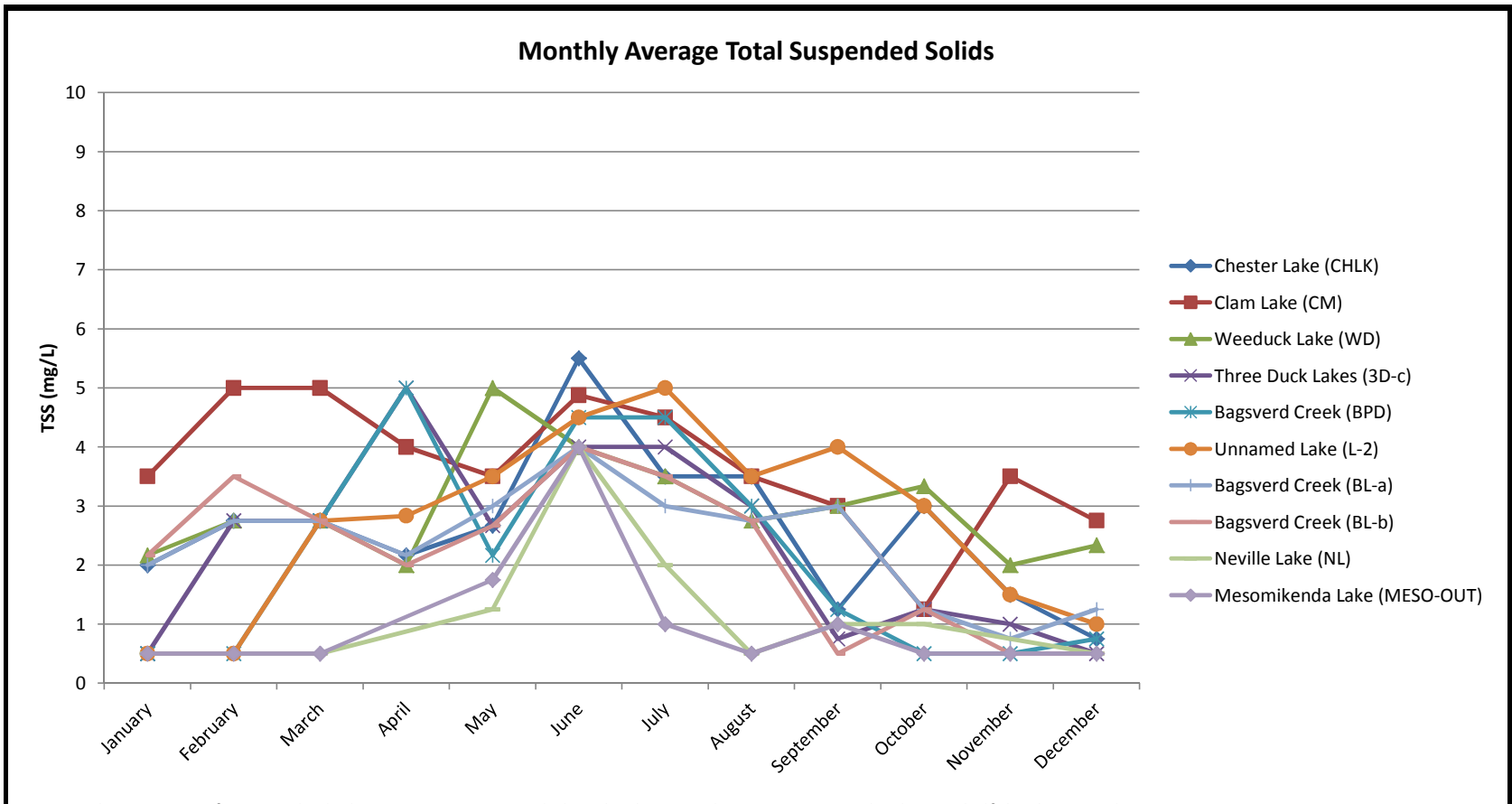

Note: For the purposes of statistical calculations, concentrations below the detection limit were assumed to be one-half the detection limit.

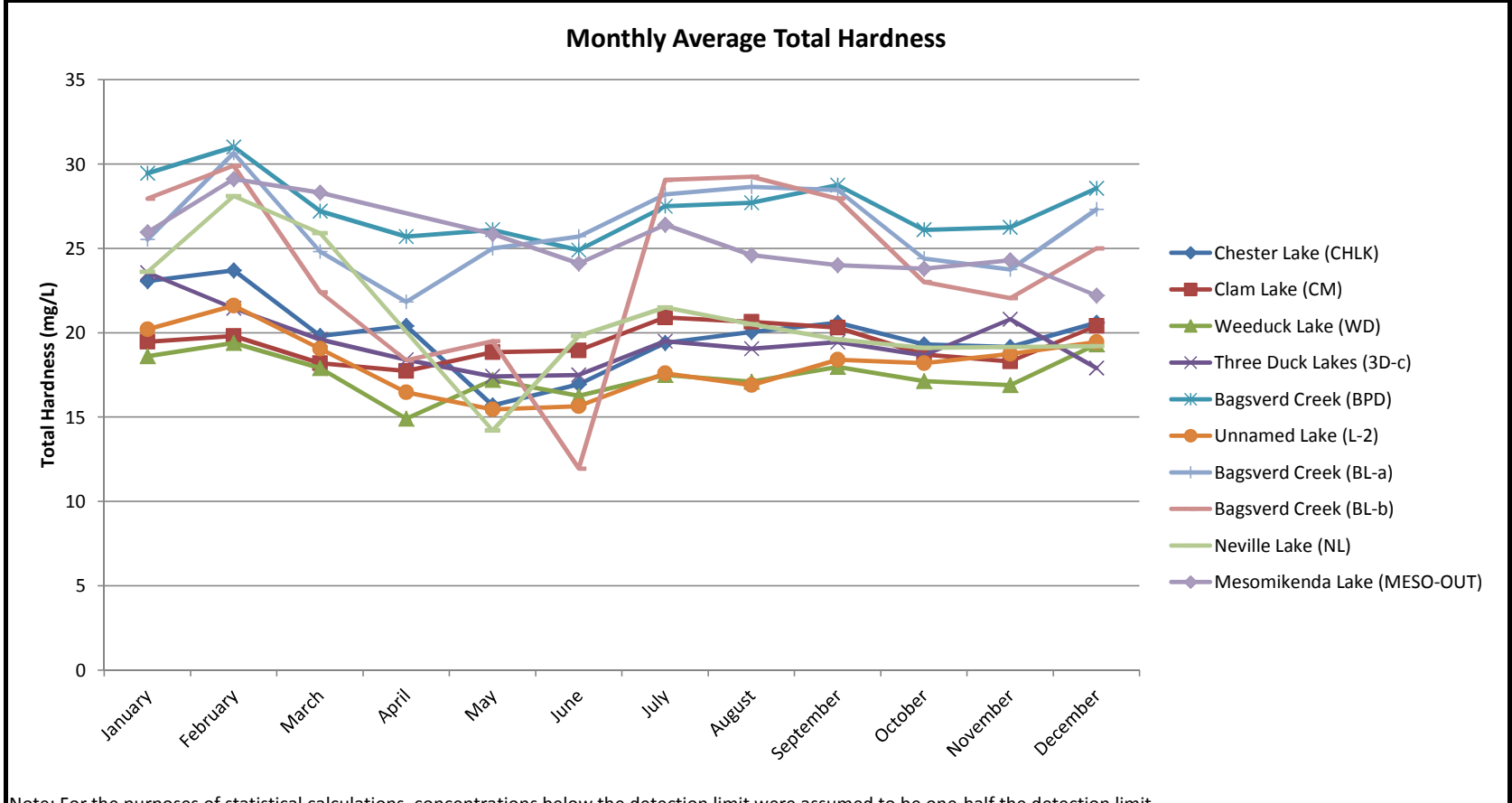

Note: For the purposes of statistical calculations, concentrations below the detection limit were assumed to be one-half the detection limit.

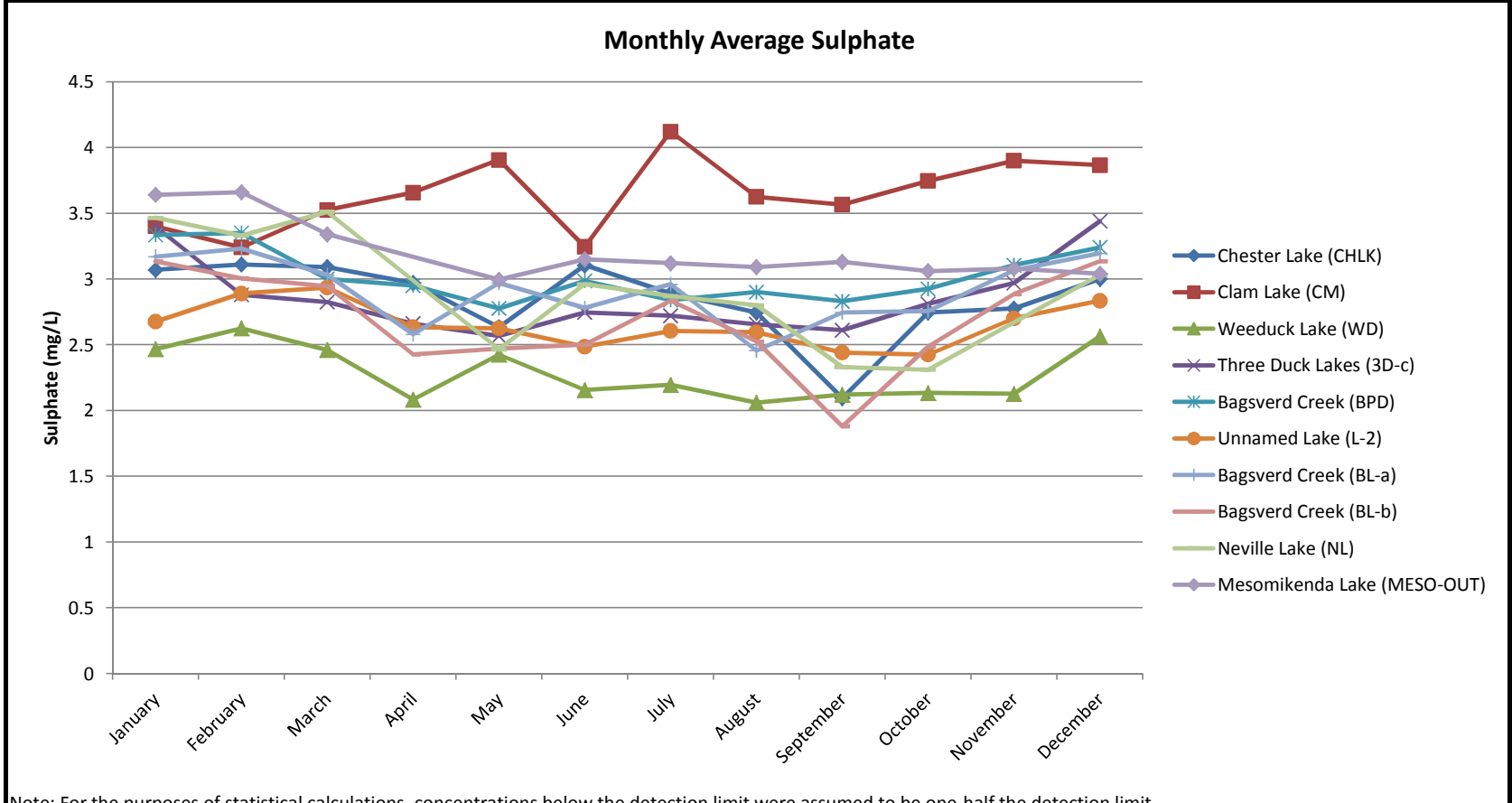

Note: For the purposes of statistical calculations, concentrations below the detection limit were assumed to be one-half the detection limit.

UPDATED BASELINE SURFACE WATER QUALITY DATASET - MONTHLY AVERAGE PARAMETER CONCENTRATIONS
CÔTÉ GOLD PROJECT

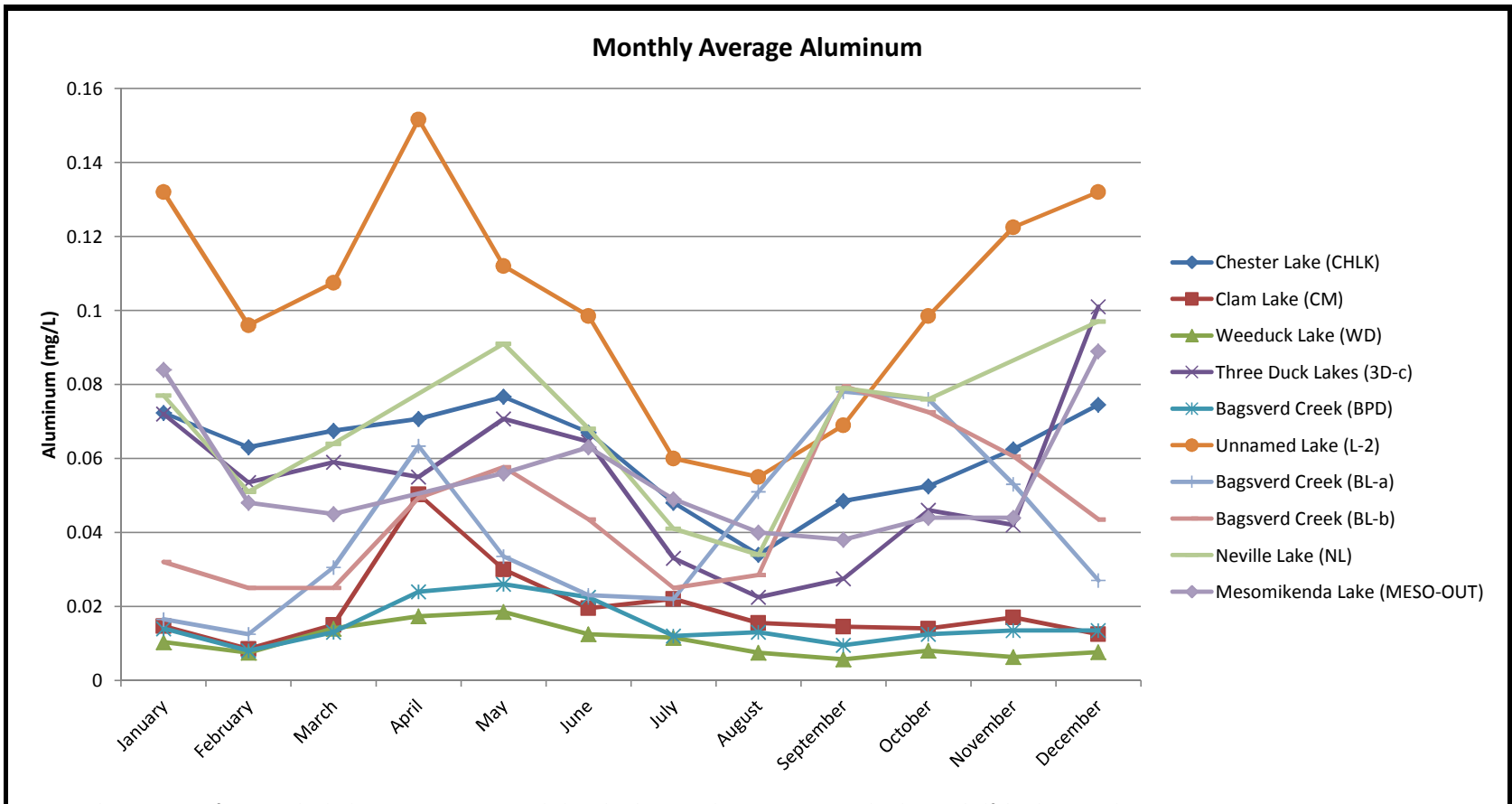

Note: For the purposes of statistical calculations, concentrations below the detection limit were assumed to be one-half the detection limit.

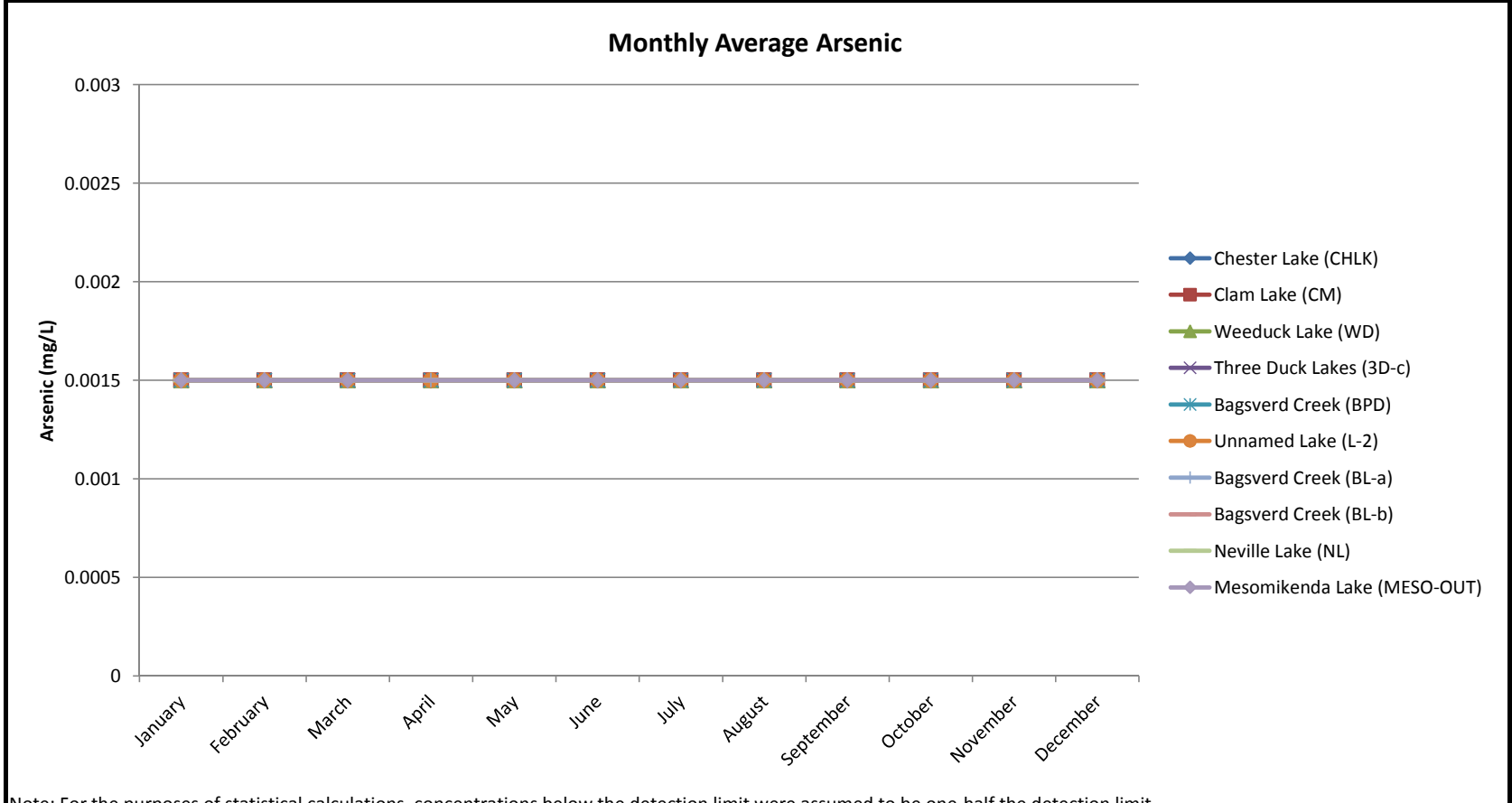

Note: For the purposes of statistical calculations, concentrations below the detection limit were assumed to be one-half the detection limit.

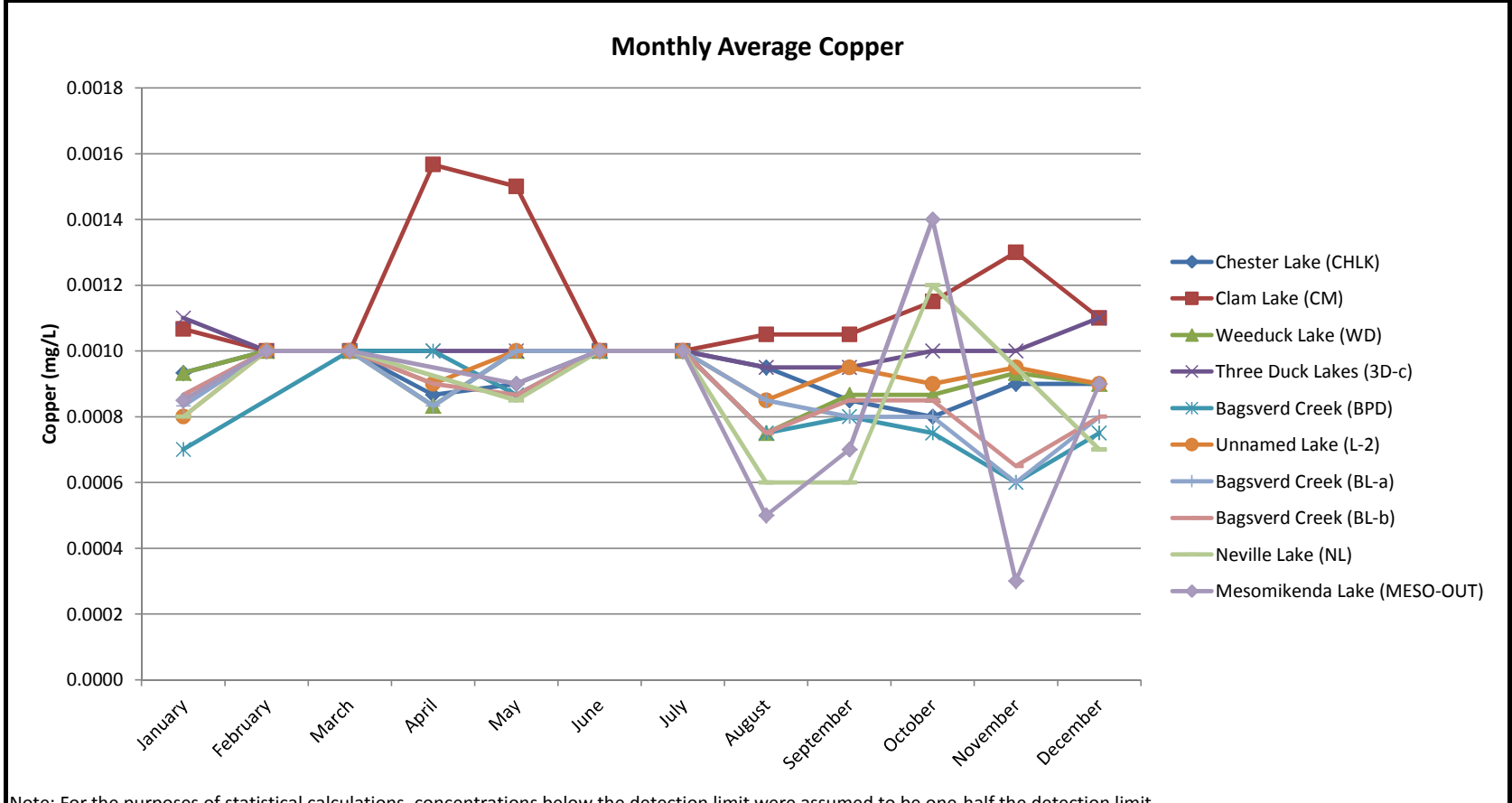

Note: For the purposes of statistical calculations, concentrations below the detection limit were assumed to be one-half the detection limit.

UPDATED BASELINE SURFACE WATER QUALITY DATASET - MONTHLY AVERAGE PARAMETER CONCENTRATIONS
CÔTÉ GOLD PROJECT

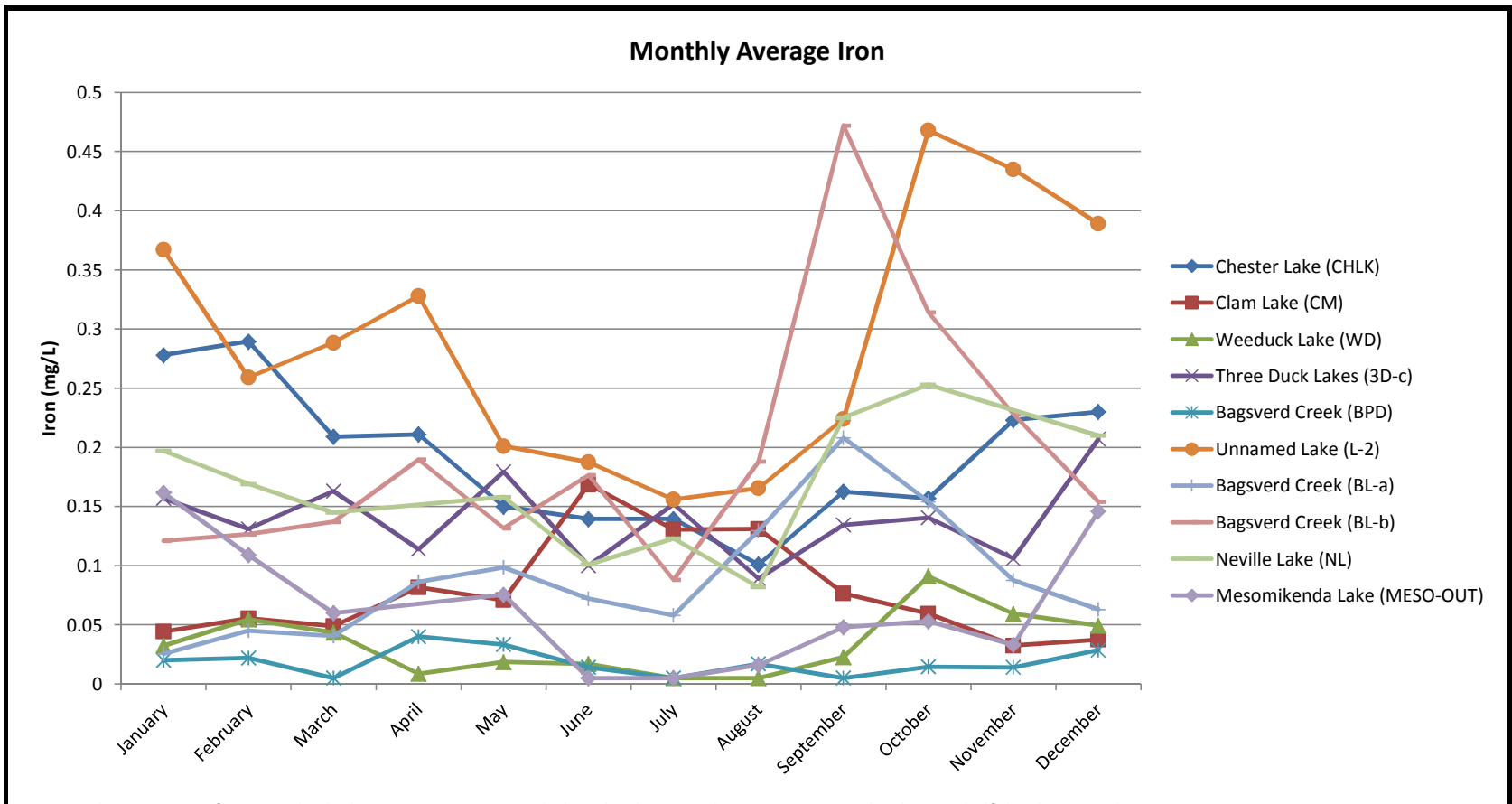

Note: For the purposes of statistical calculations, concentrations below the detection limit were assumed to be one-half the detection limit.

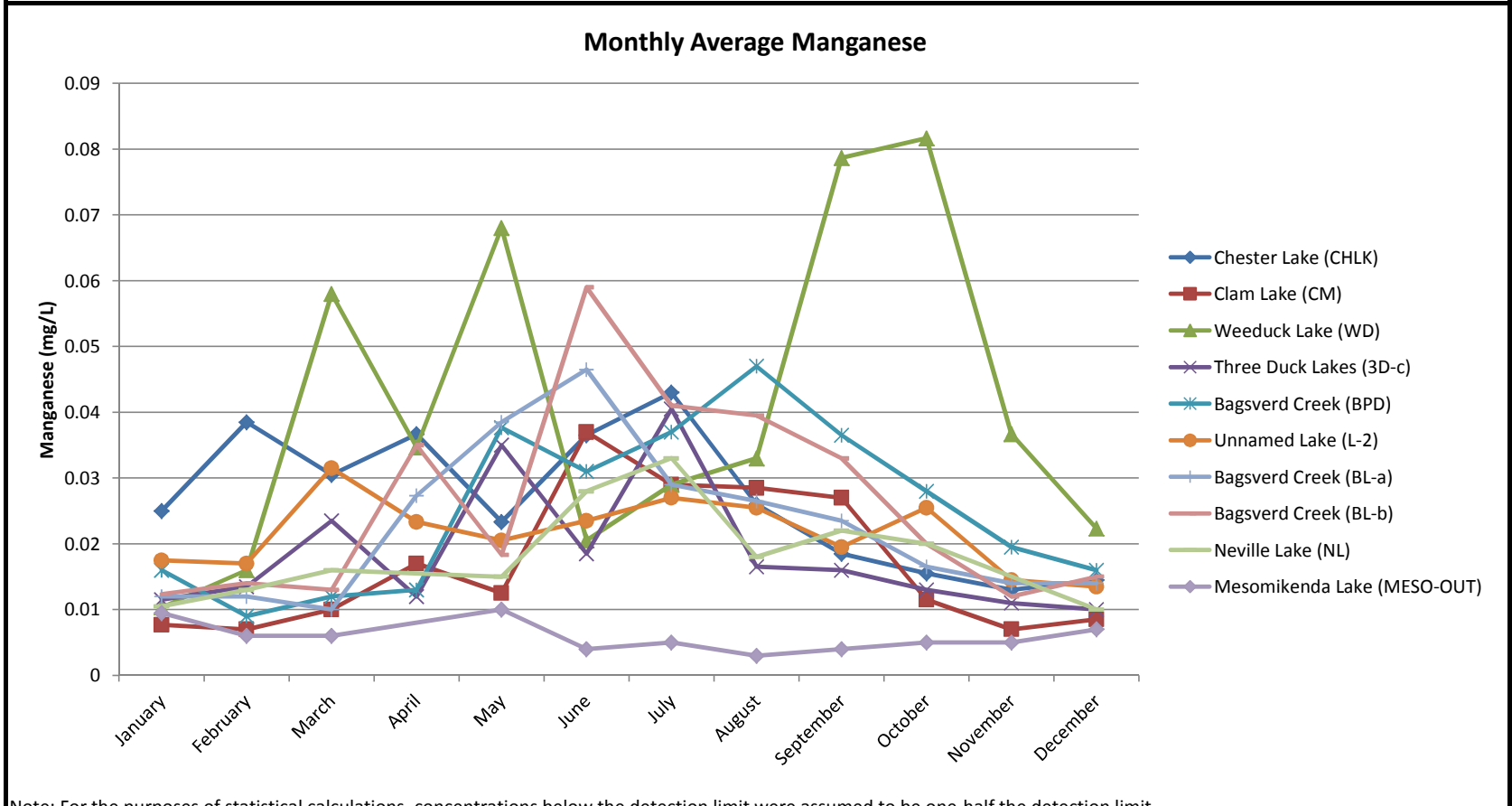

Note: For the purposes of statistical calculations, concentrations below the detection limit were assumed to be one-half the detection limit.

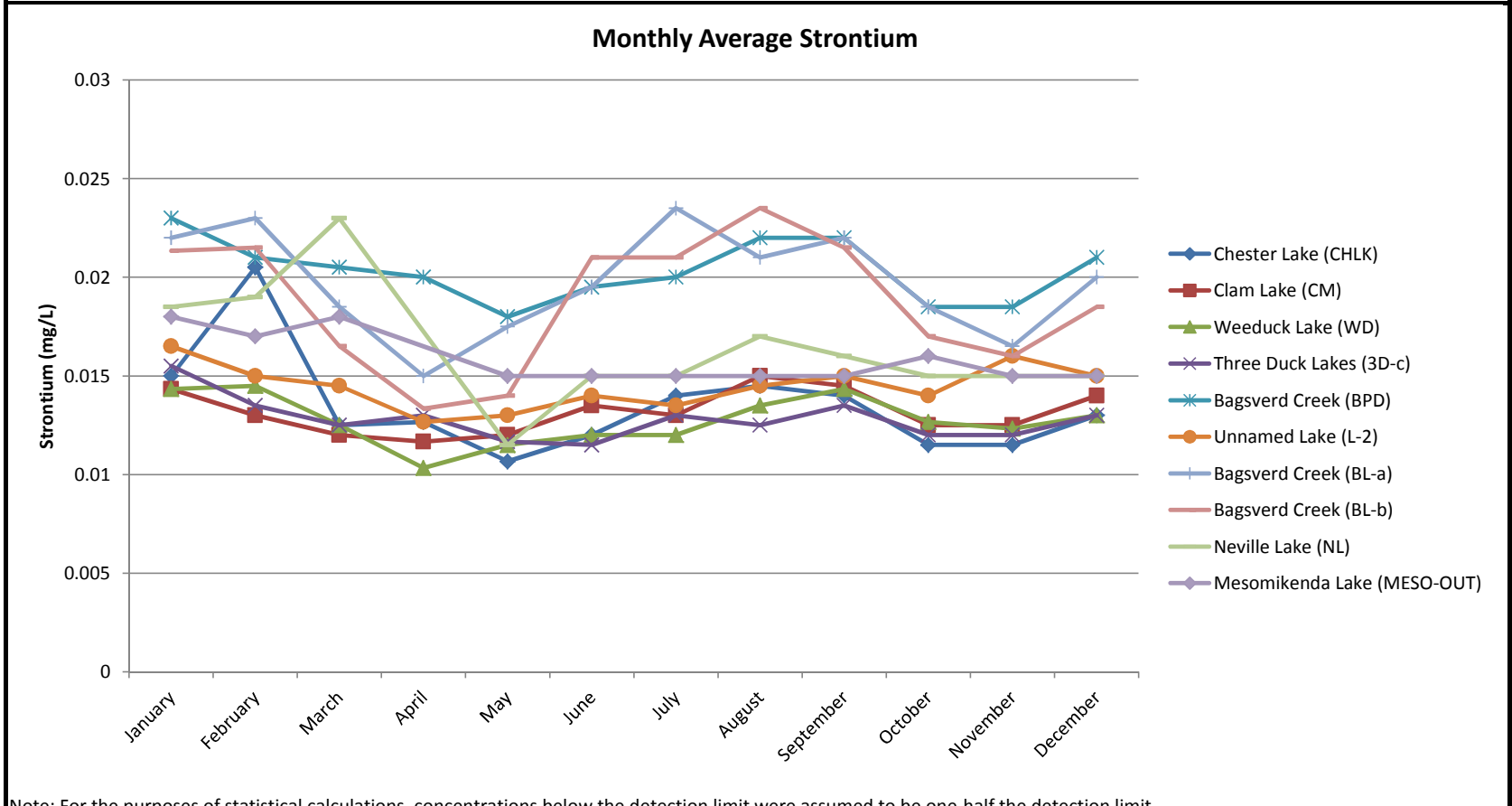

Note: For the purposes of statistical calculations, concentrations below the detection limit were assumed to be one-half the detection limit.

UPDATED BASELINE SURFACE WATER QUALITY DATASET - MONTHLY AVERAGE PARAMETER CONCENTRATIONS
CÔTÉ GOLD PROJECT

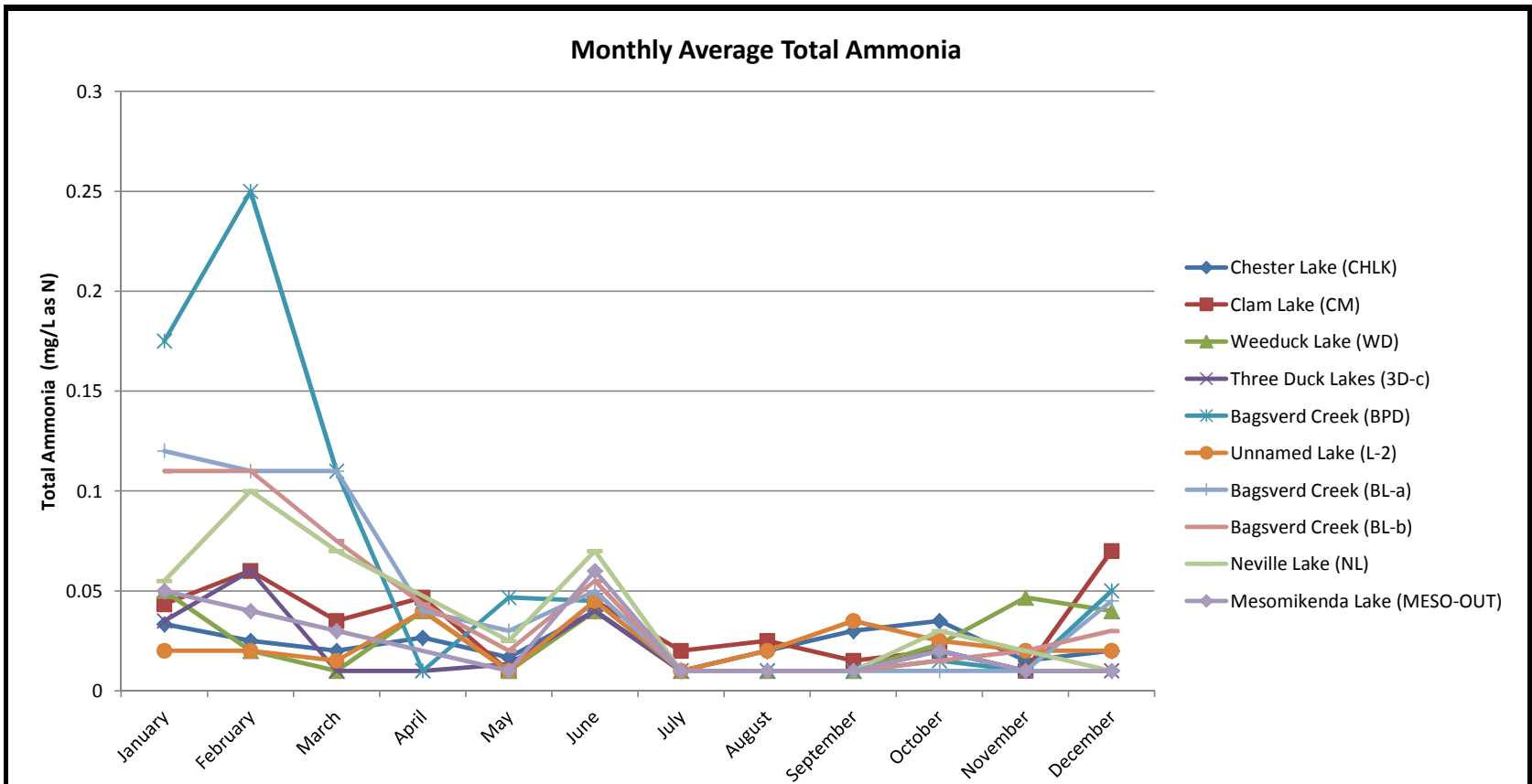

Note: For the purposes of statistical calculations, concentrations below the detection limit were assumed to be one-half the detection limit.

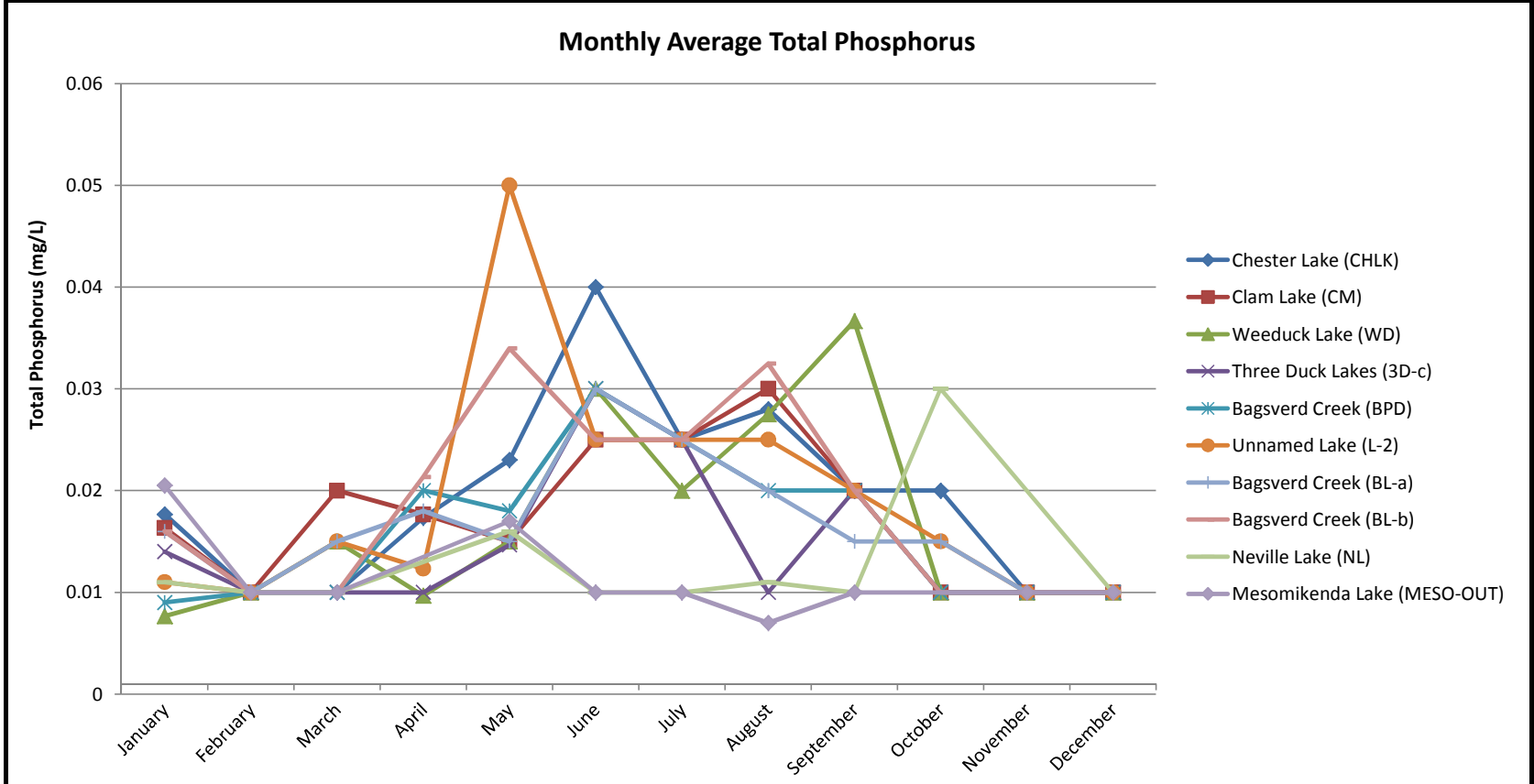

Note: For the purposes of statistical calculations, concentrations below the detection limit were assumed to be one-half the detection limit.

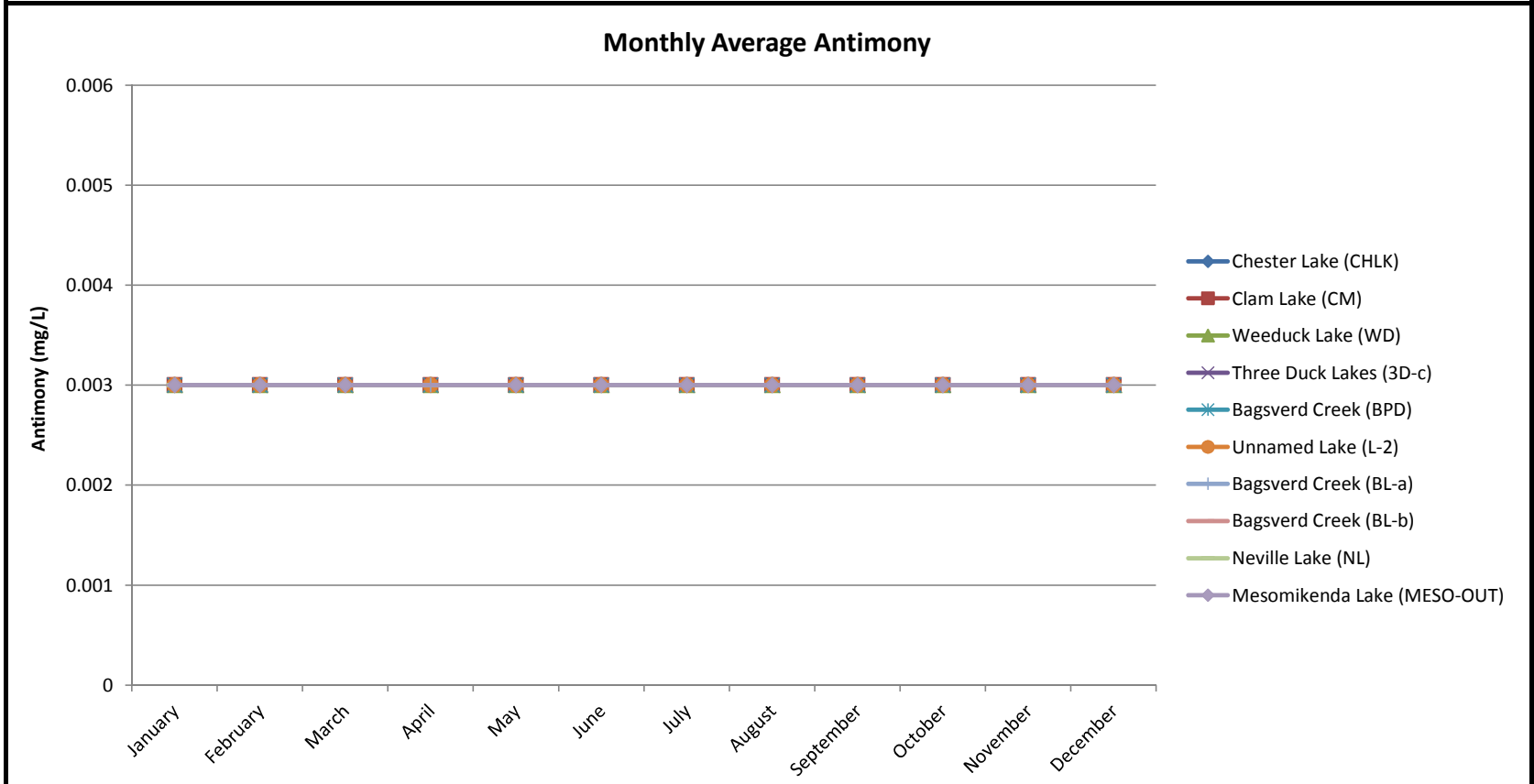

Note: For the purposes of statistical calculations, concentrations below the detection limit were assumed to be one-half the detection limit.

UPDATED BASELINE SURFACE WATER QUALITY DATASET - MONTHLY AVERAGE PARAMETER CONCENTRATIONS
CÔTÉ GOLD PROJECT

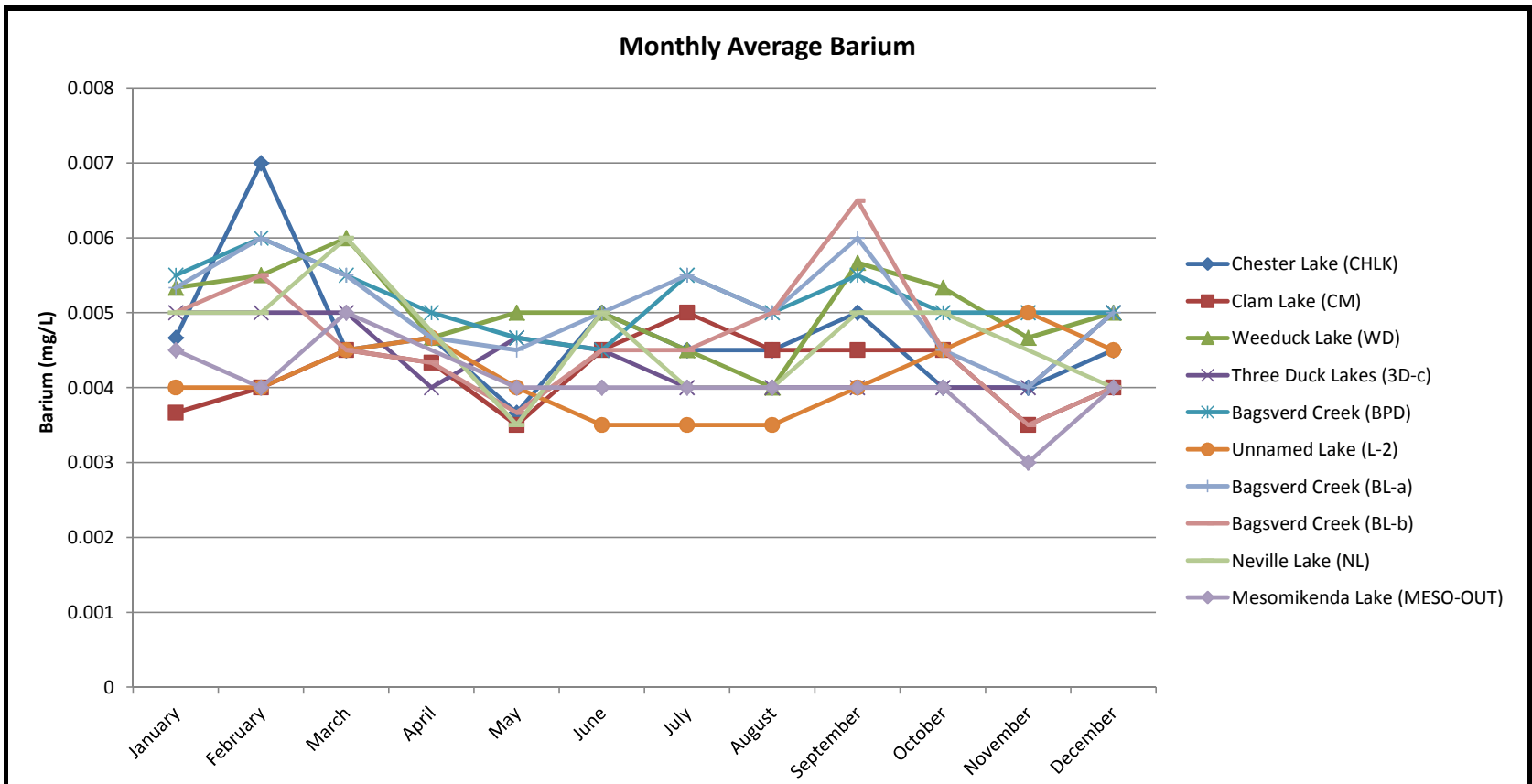

Note: For the purposes of statistical calculations, concentrations below the detection limit were assumed to be one-half the detection limit.

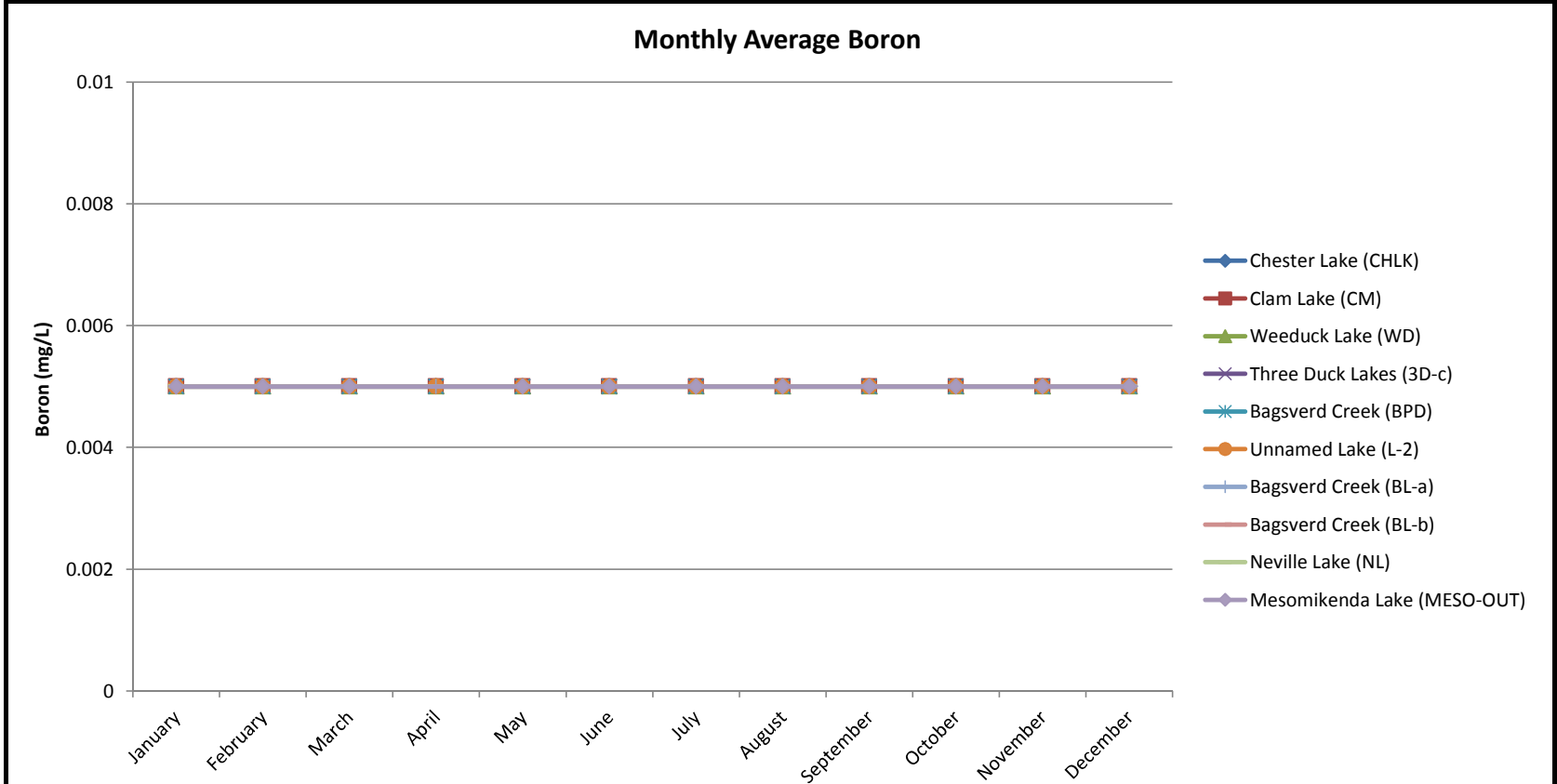

Note: For the purposes of statistical calculations, concentrations below the detection limit were assumed to be one-half the detection limit.

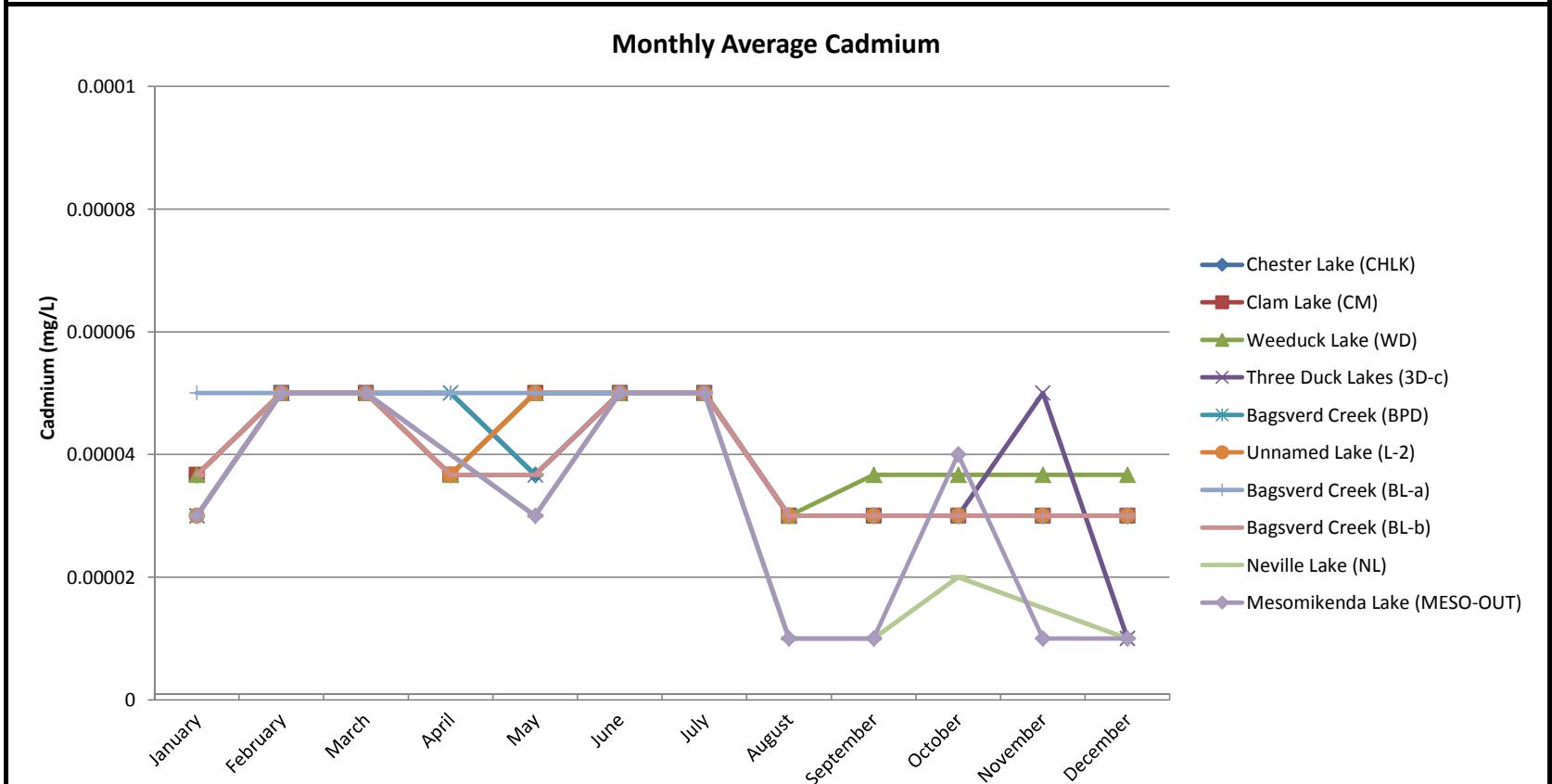

Note: For the purposes of statistical calculations, concentrations below the detection limit were assumed to be one-half the detection limit.

UPDATED BASELINE SURFACE WATER QUALITY DATASET - MONTHLY AVERAGE PARAMETER CONCENTRATIONS
CÔTÉ GOLD PROJECT

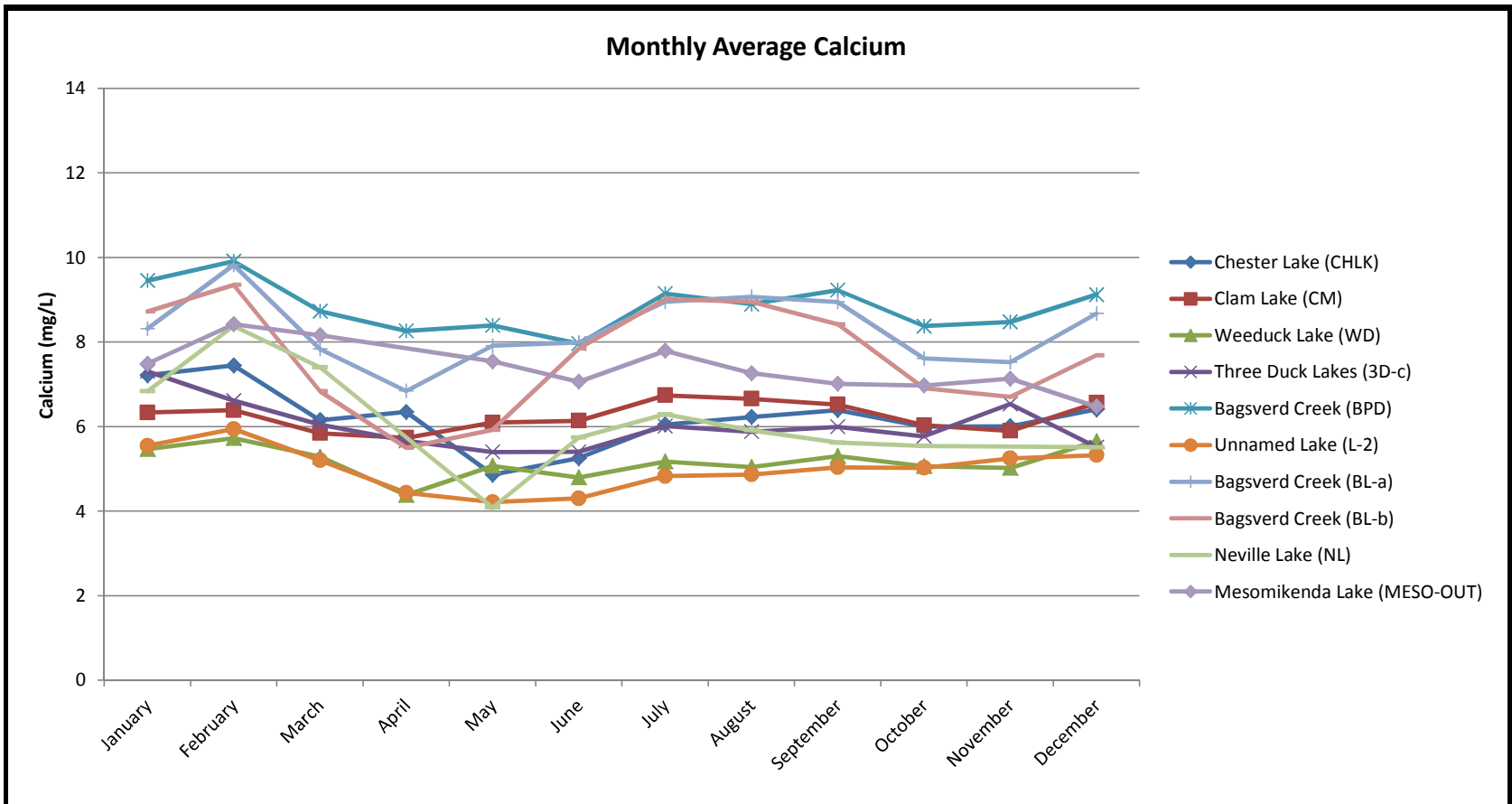

Note: For the purposes of statistical calculations, concentrations below the detection limit were assumed to be one-half the detection limit.

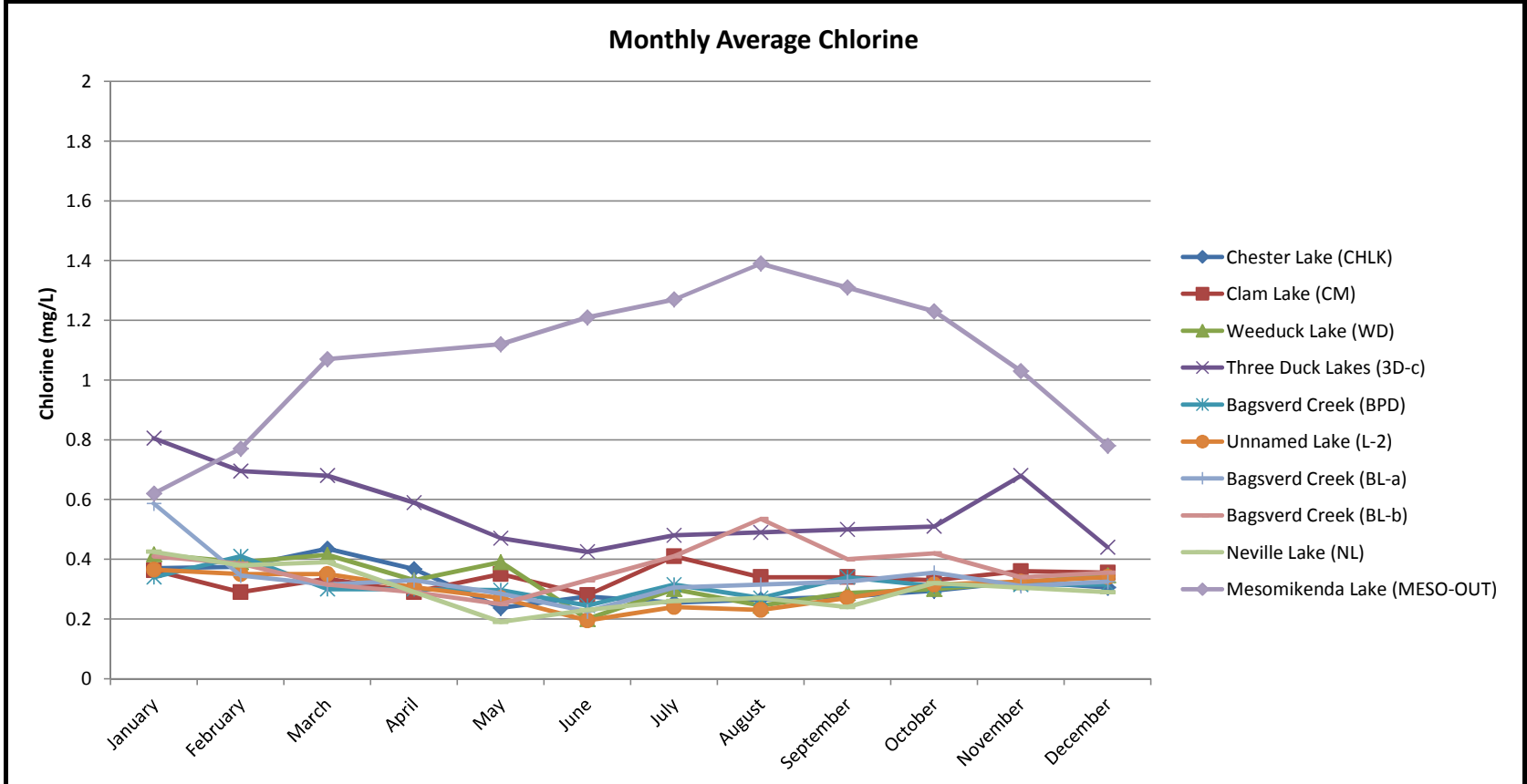

Note: For the purposes of statistical calculations, concentrations below the detection limit were assumed to be one-half the detection limit.

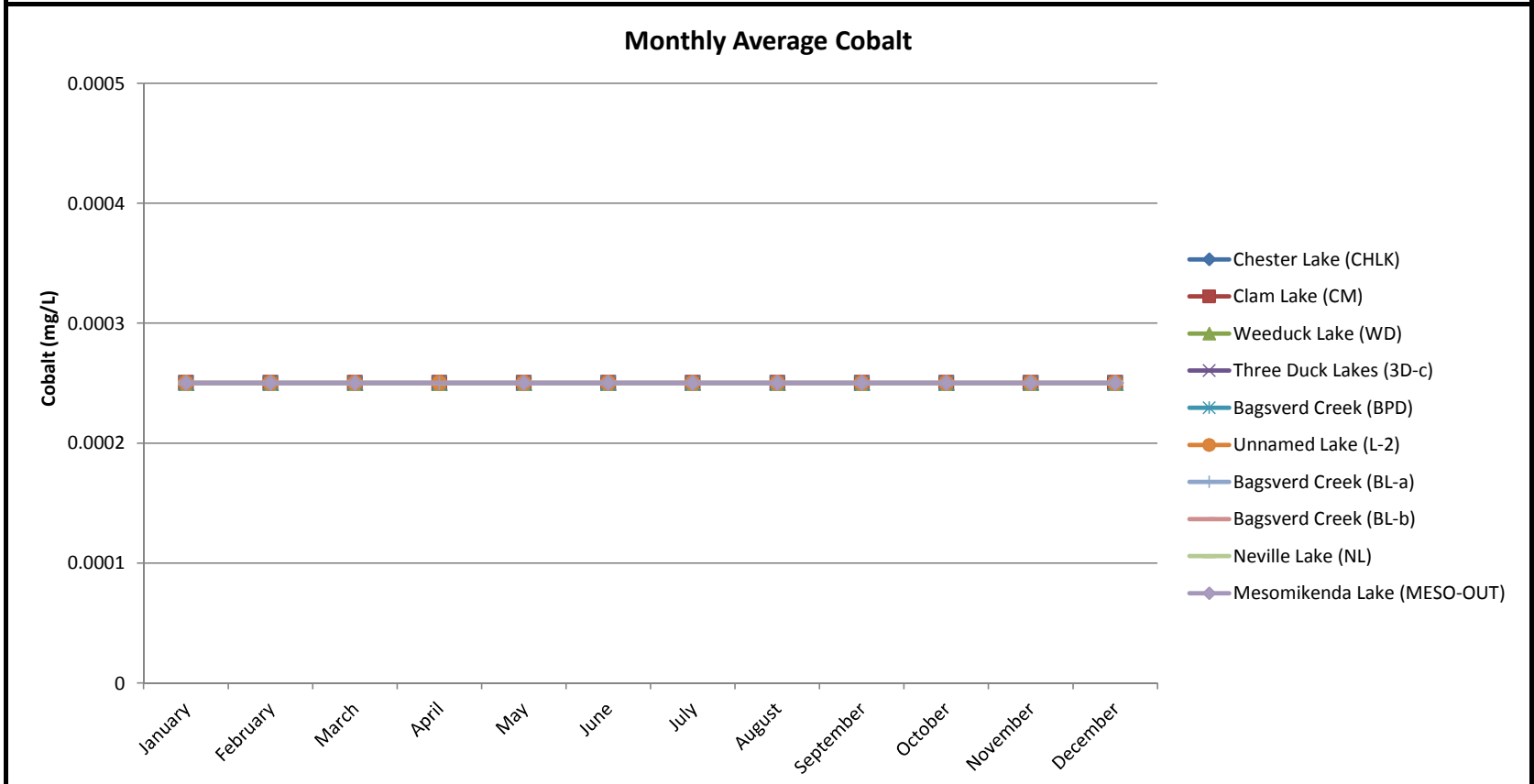

Note: For the purposes of statistical calculations, concentrations below the detection limit were assumed to be one-half the detection limit.

UPDATED BASELINE SURFACE WATER QUALITY DATASET - MONTHLY AVERAGE PARAMETER CONCENTRATIONS
CÔTÉ GOLD PROJECT

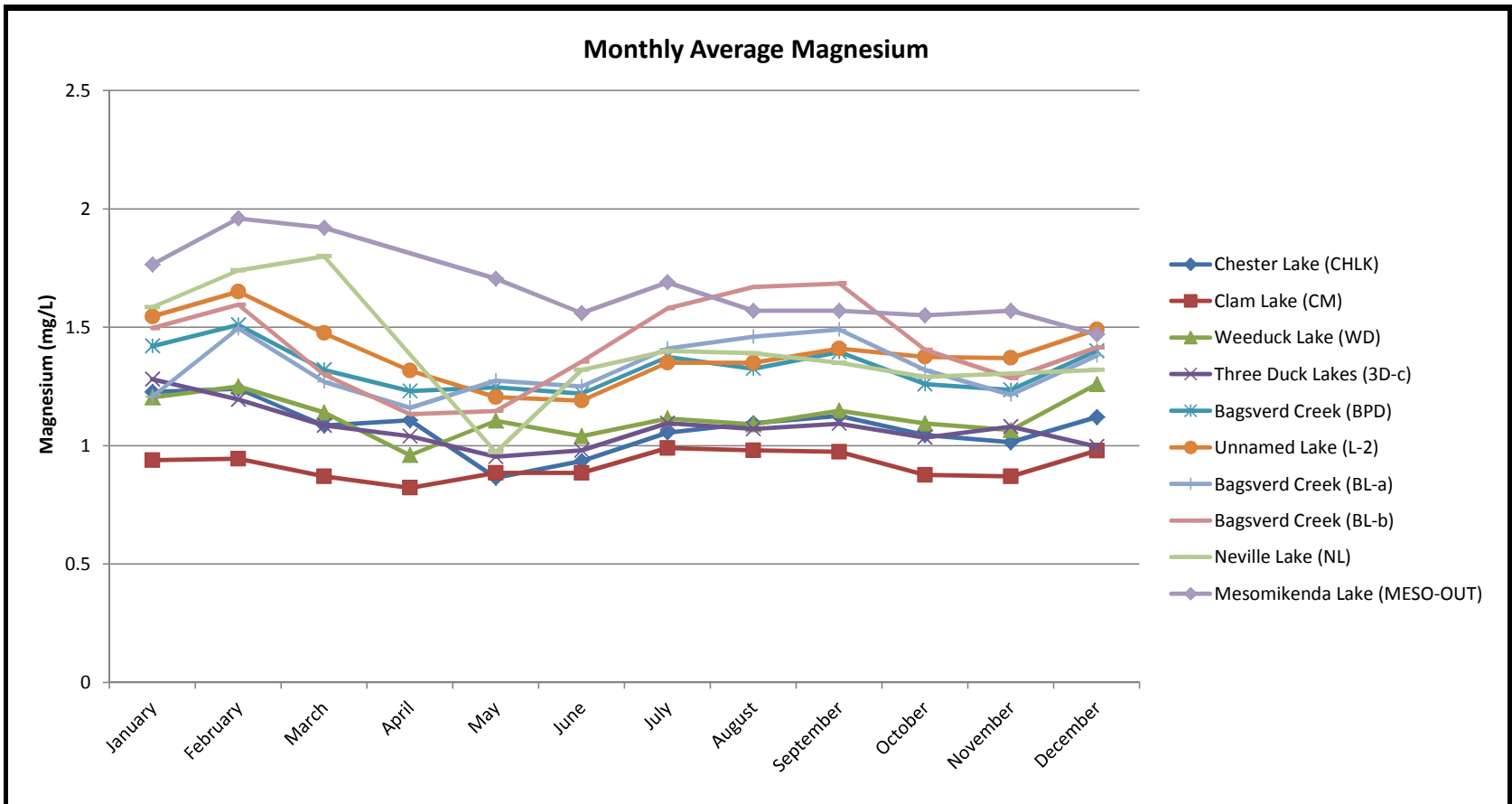

Note: For the purposes of statistical calculations, concentrations below the detection limit were assumed to be one-half the detection limit.

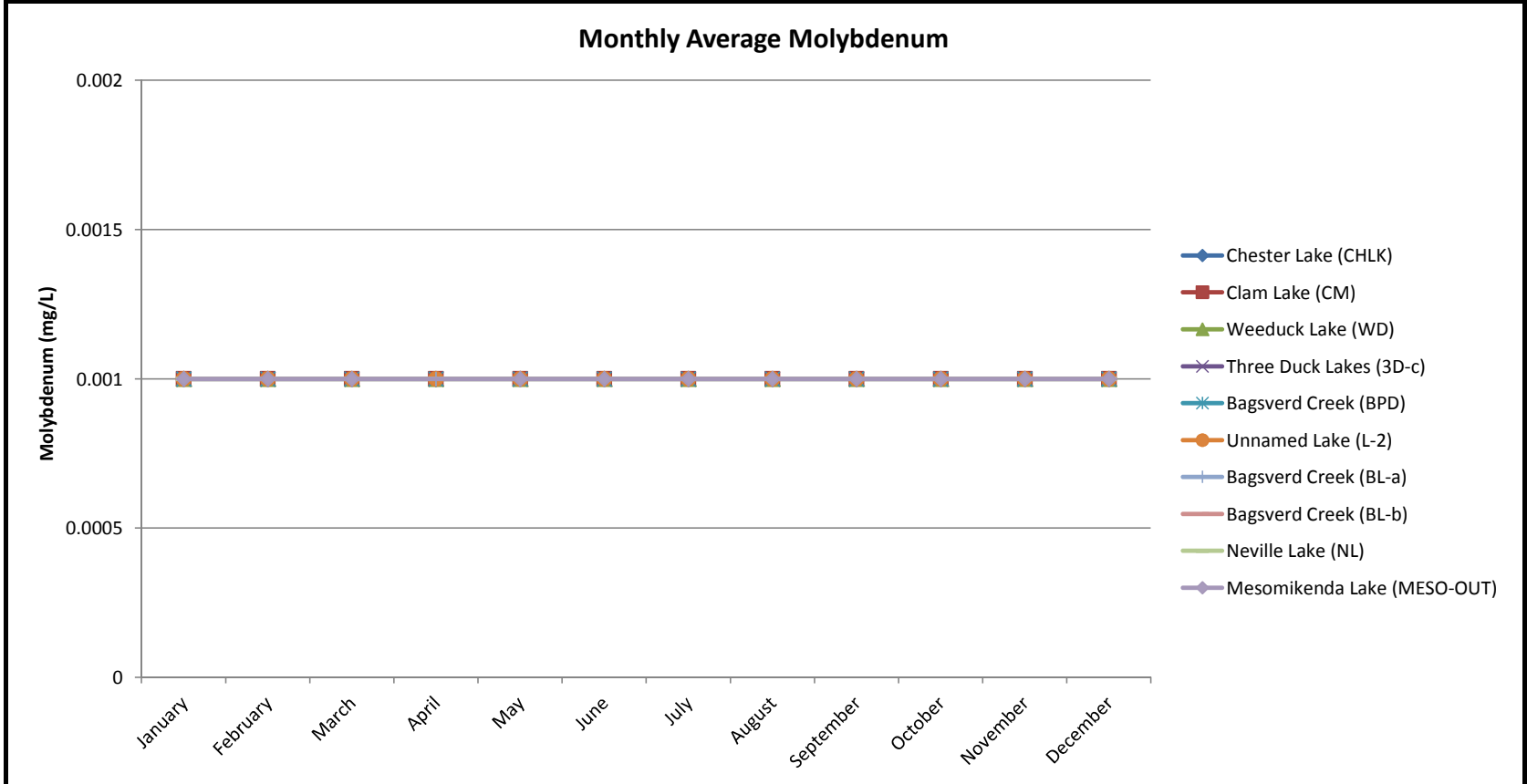

Note: For the purposes of statistical calculations, concentrations below the detection limit were assumed to be one-half the detection limit.

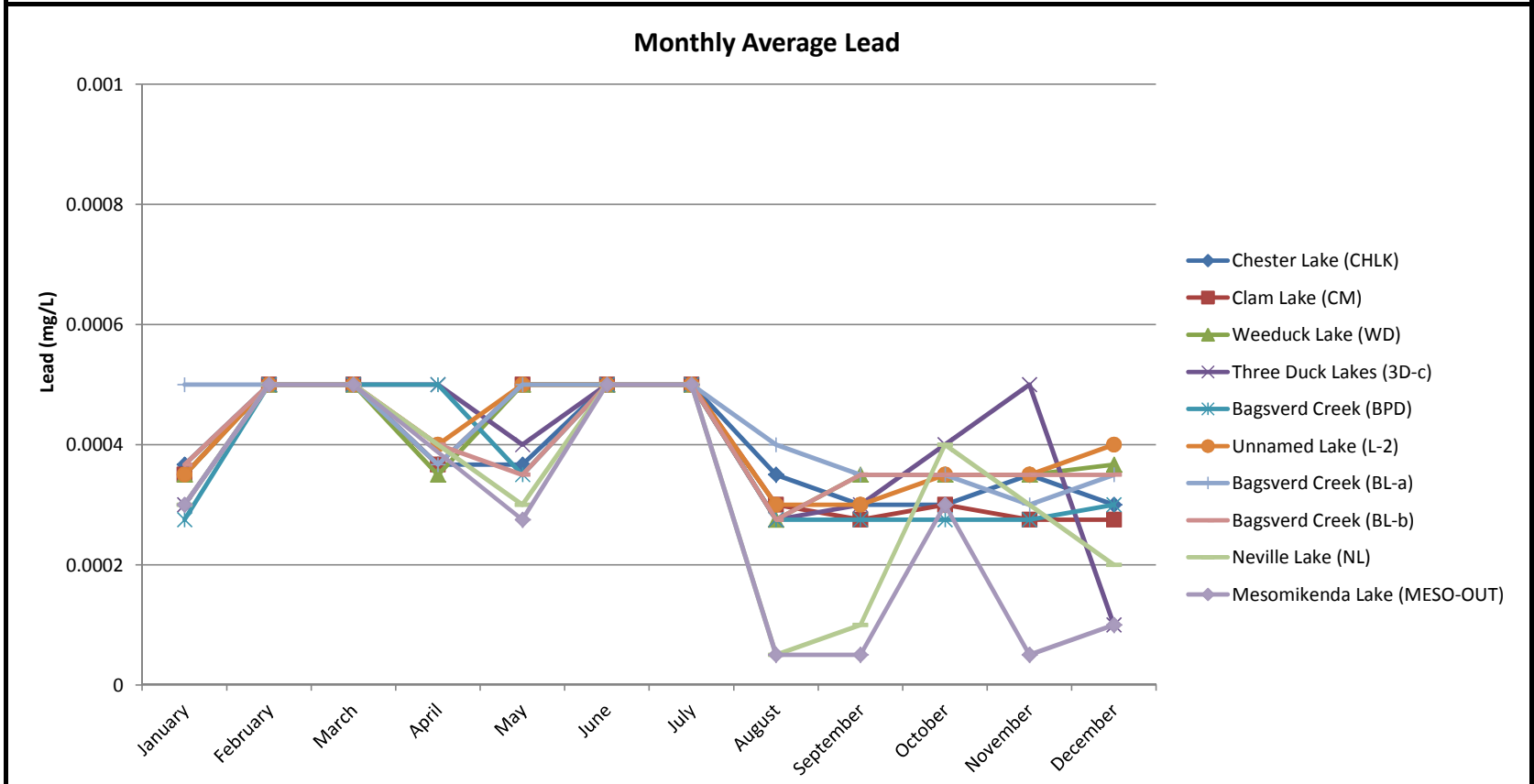

Note: For the purposes of statistical calculations, concentrations below the detection limit were assumed to be one-half the detection limit.

UPDATED BASELINE SURFACE WATER QUALITY DATASET - MONTHLY AVERAGE PARAMETER CONCENTRATIONS
CÔTÉ GOLD PROJECT

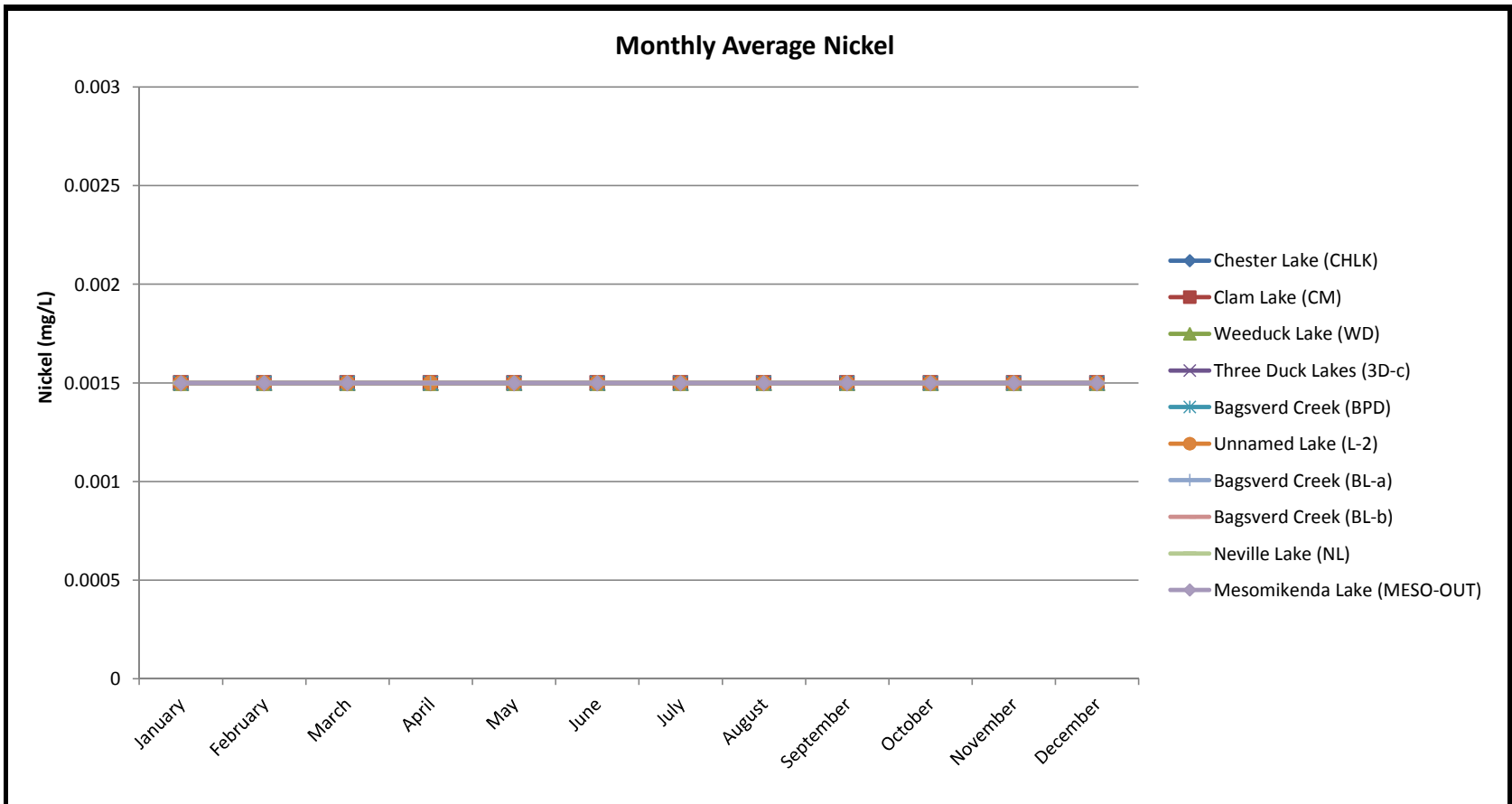

Note: For the purposes of statistical calculations, concentrations below the detection limit were assumed to be one-half the detection limit.

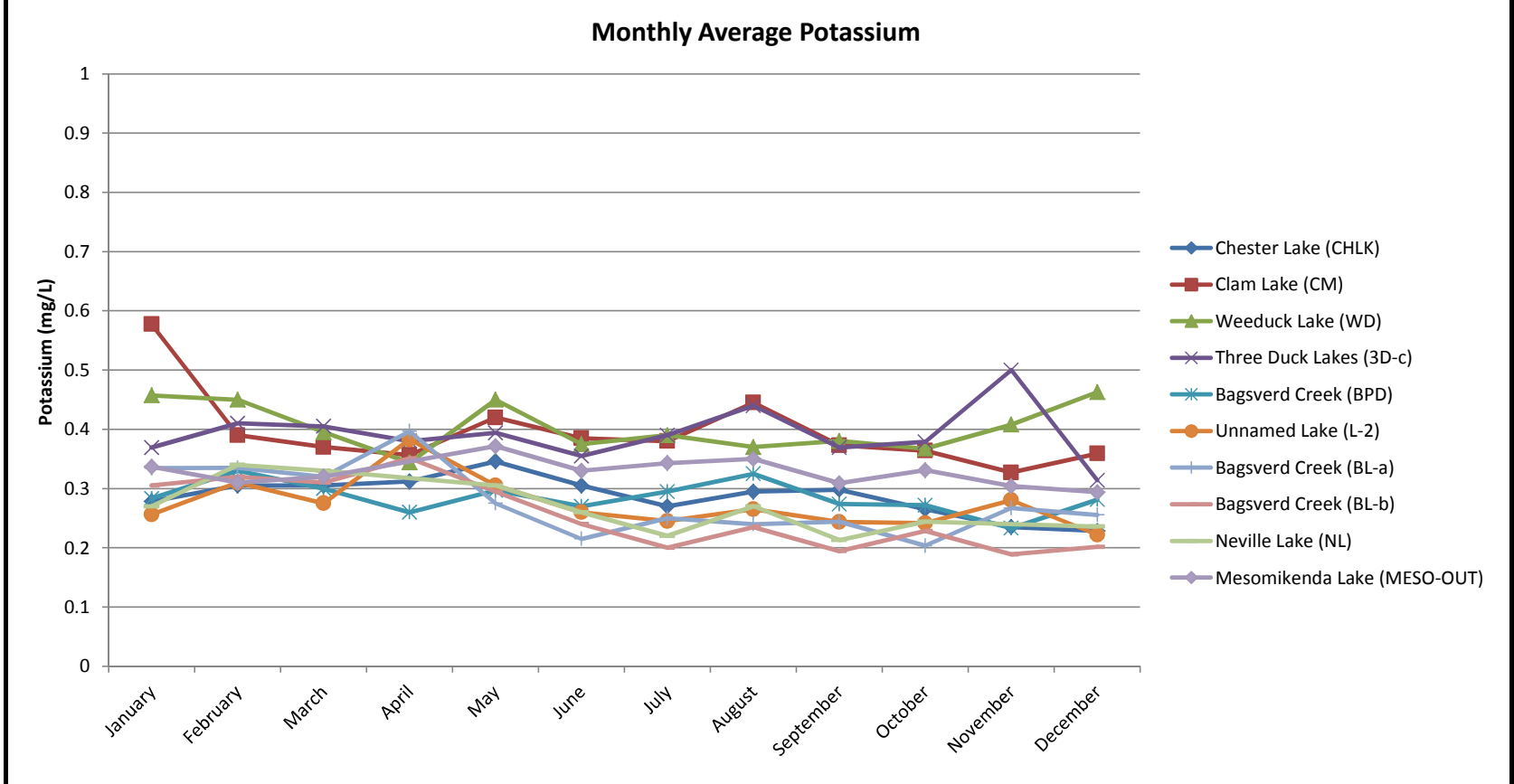

Note: For the purposes of statistical calculations, concentrations below the detection limit were assumed to be one-half the detection limit.

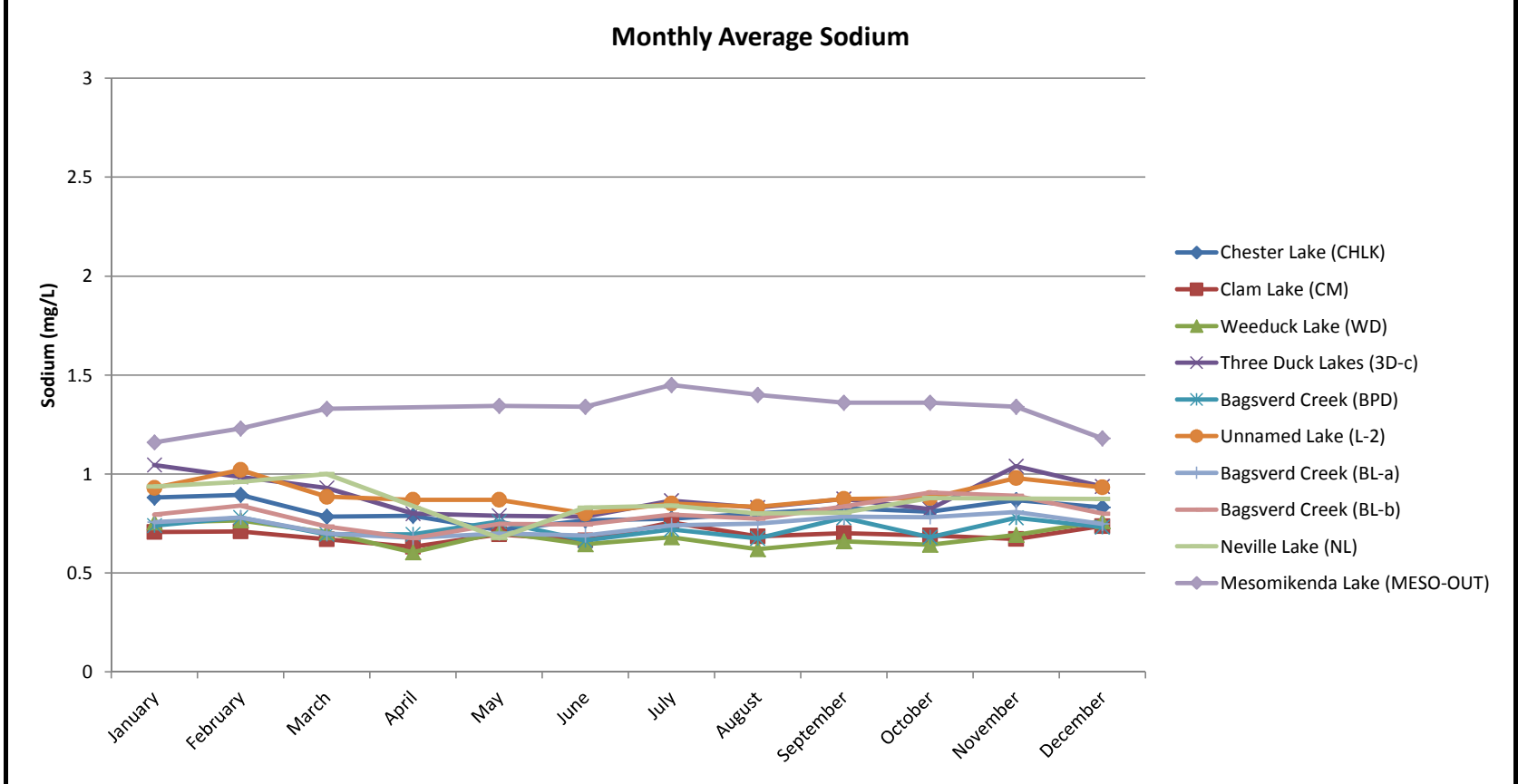

Note: For the purposes of statistical calculations, concentrations below the detection limit were assumed to be one-half the detection limit.

UPDATED BASELINE SURFACE WATER QUALITY DATASET - MONTHLY AVERAGE PARAMETER CONCENTRATIONS
CÔTÉ GOLD PROJECT

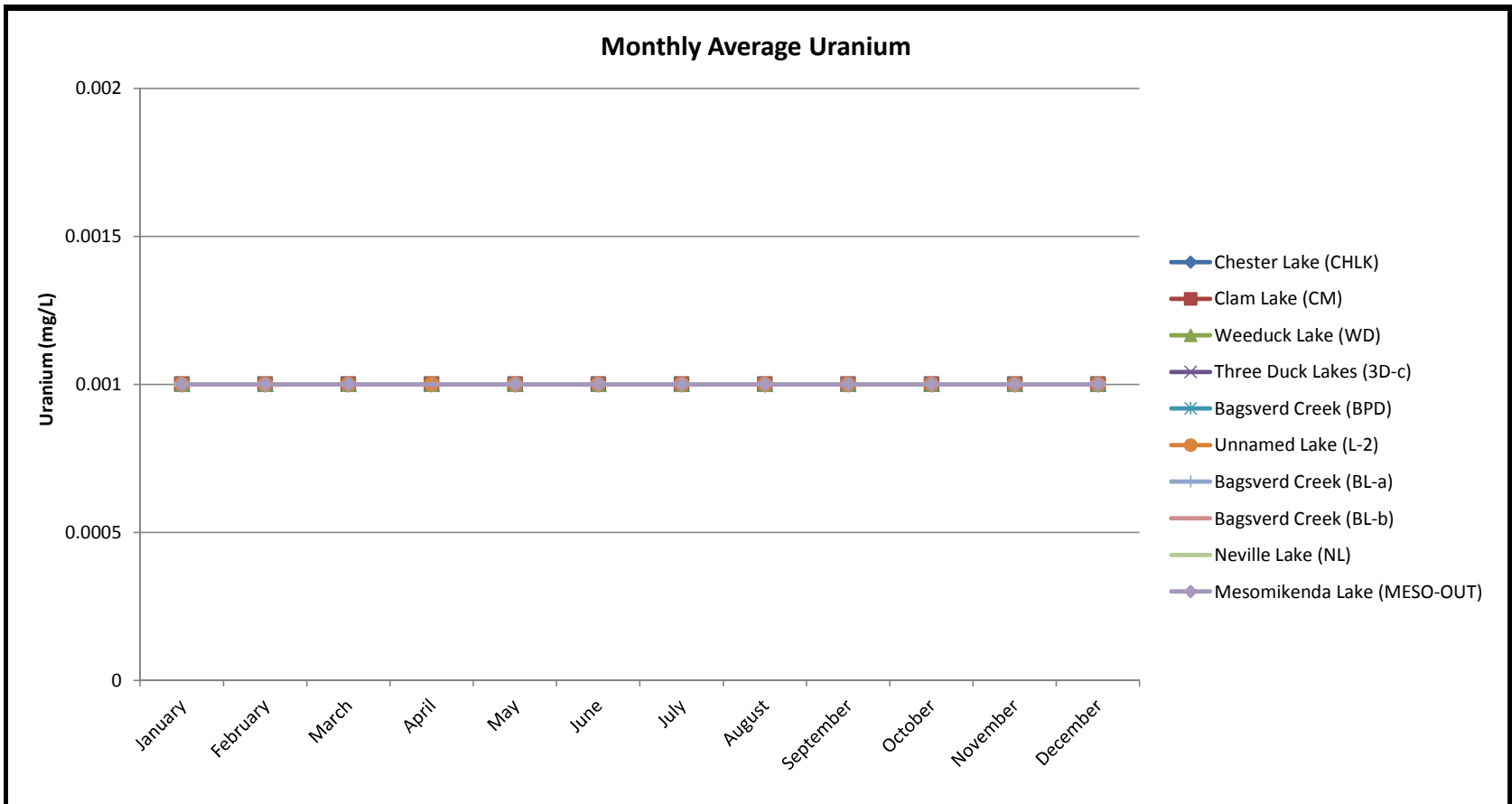

Note: For the purposes of statistical calculations, concentrations below the detection limit were assumed to be one-half the detection limit.

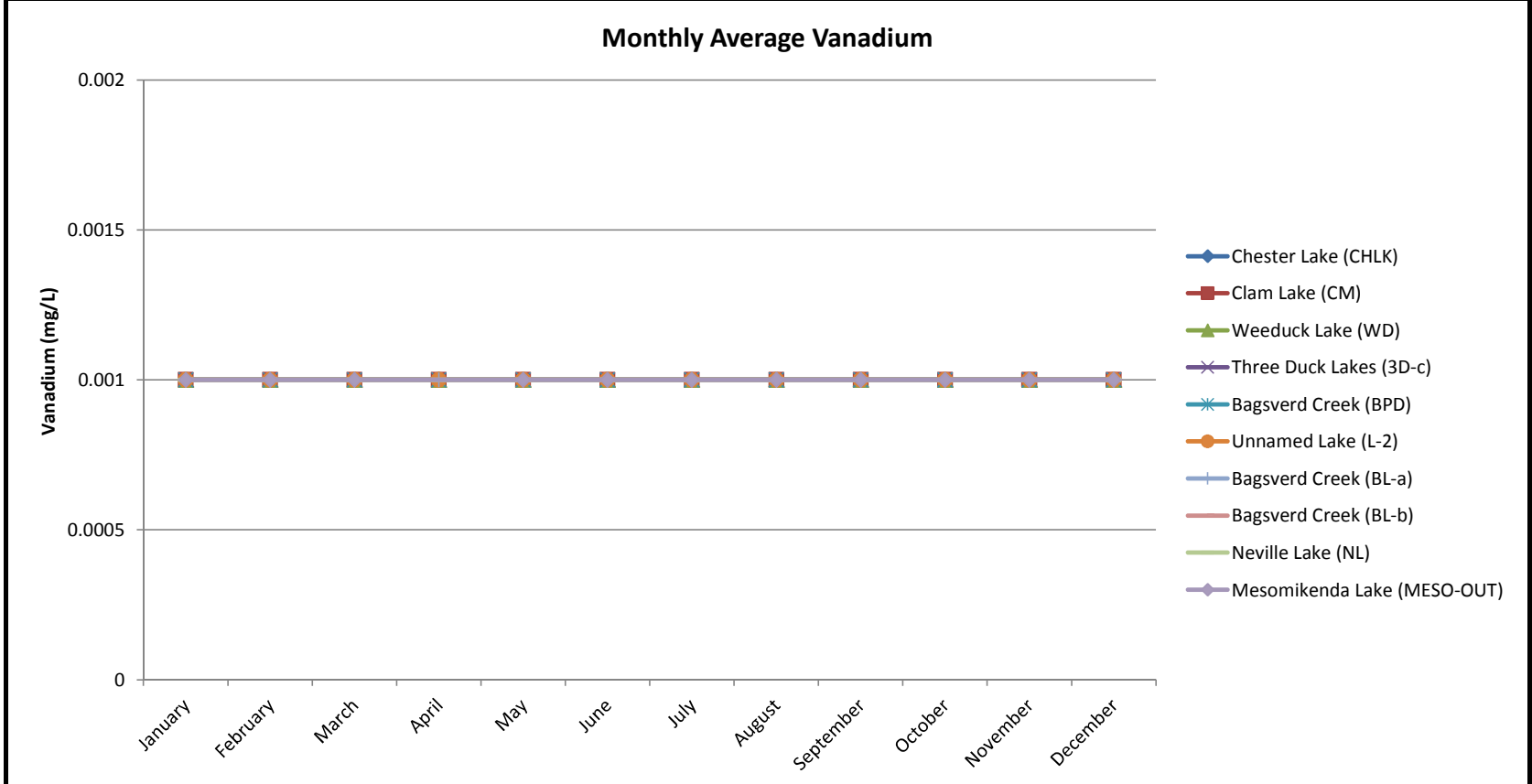

Note: For the purposes of statistical calculations, concentrations below the detection limit were assumed to be one-half the detection limit.

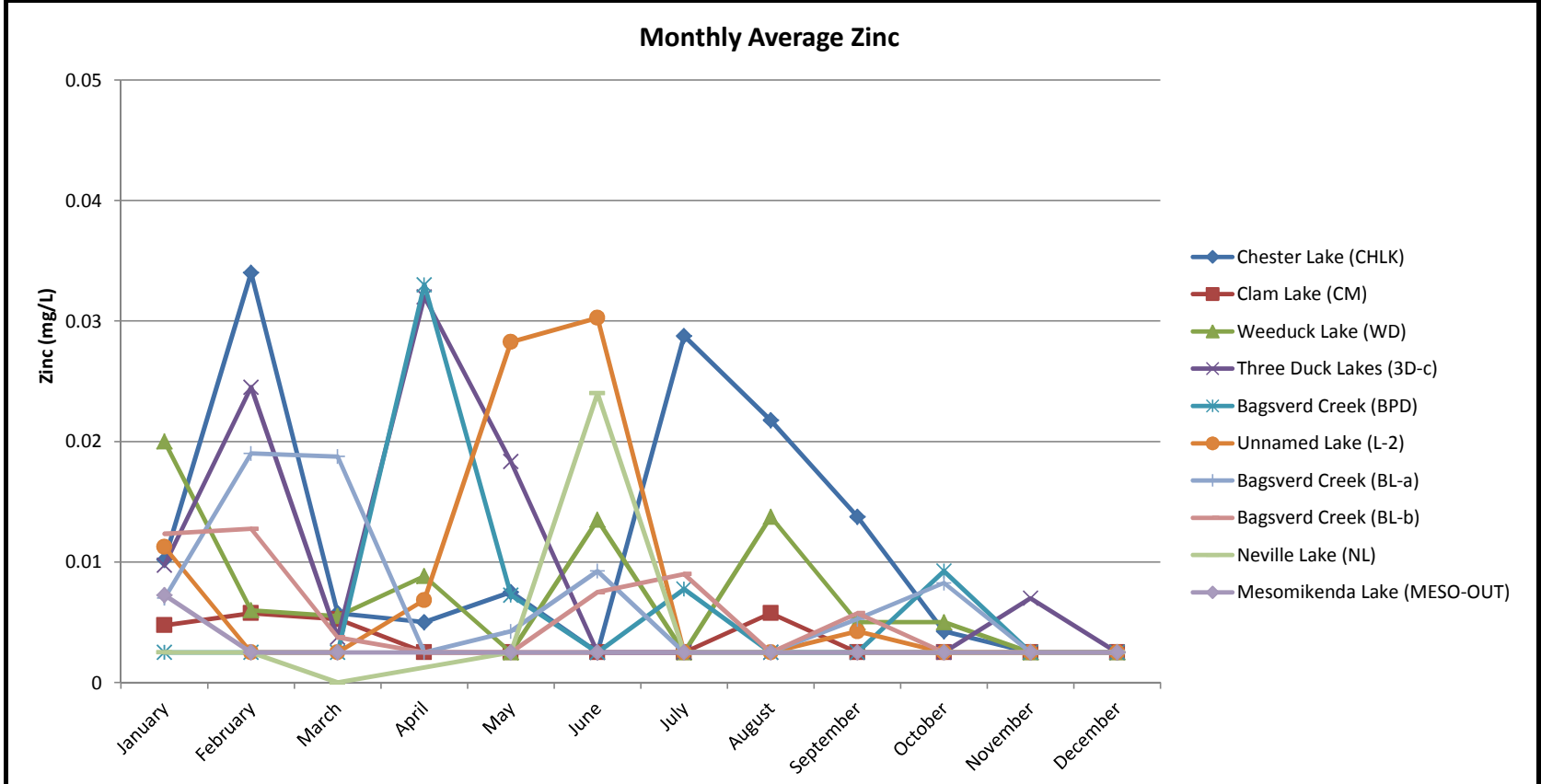

Note: For the purposes of statistical calculations, concentrations below the detection limit were assumed to be one-half the detection limit.

**MONTHLY AVERAGE FREE CYANIDE CONCENTRATIONS IN UNNAMED LAKE #1 AND BAGSVERD CREEK
CÔTÉ GOLD PROJECT**

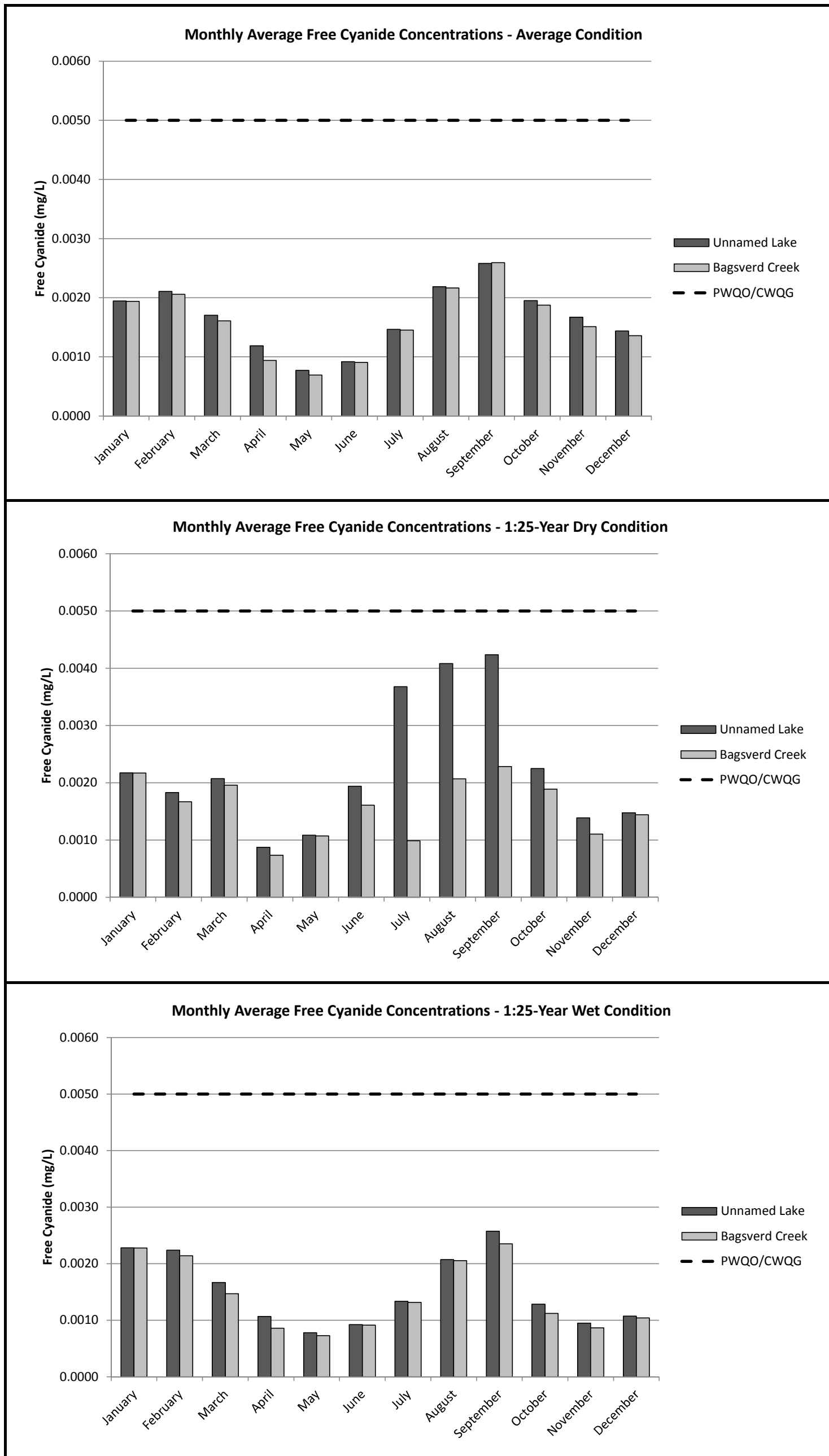

Notes:

Predicted free cyanide concentrations are derived from revised simulations that account for newly available process water quality data and the natural attenuation of cyanide in the vadose zone of the Tailings Management Facility.

PWQO - Provincial Water Quality Objectives, Ministry of Environment and Energy (1994, Revised 1999).

CWQG - Canadian Water Quality Guidelines for the protection of aquatic life. Canadian Environmental Quality Guidelines, Canadian Council of Ministers of the Environment, September 2003 (CCME 2003).



5267000

5267000

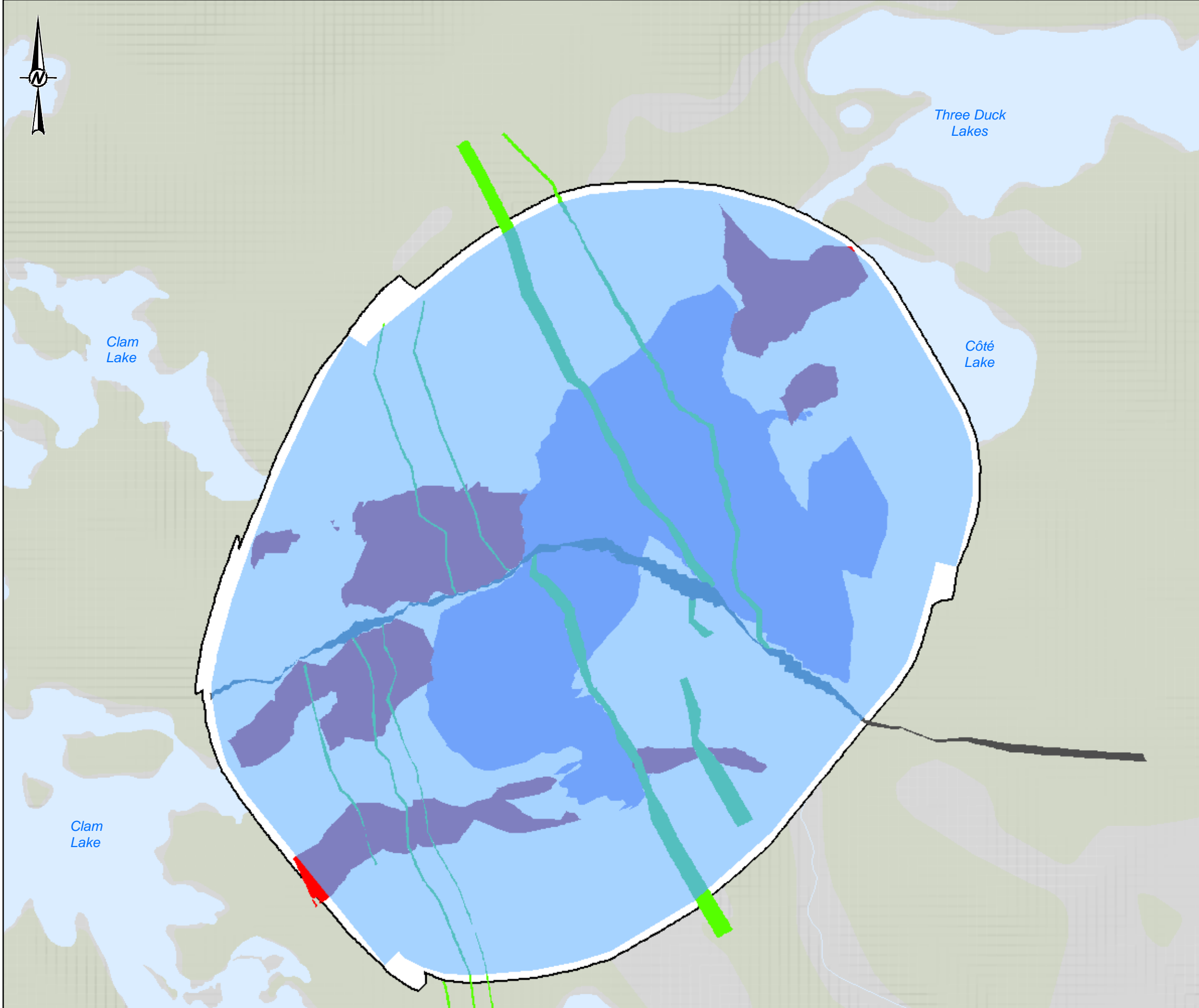

- LEGEND
- Lithology - Pit Intersection**
- (Below Water)**
- Breccia
 - Diabase
 - Diorite
 - Fault
- (Above Water)**
- Diabase
 - Diorite
 - Fault
 - Tonalite (above water)
 - Tonalite (below water)
 - Open Pit
 - Rivers
 - Waterbody / Large Watercourse
 - Wooded Areas

NOTES

THIS FIGURE IS TO BE READ IN CONJUNCTION WITH THE ACCOMPANYING GOLDER ASSOCIATES LTD. REPORT NO. 1400877

REFERENCE

CONTAINS INFORMATION LICENSED UNDER THE OPEN GOVERNMENT LICENCE – ONTARIO.
[HTTPS://WWW.ONTARIO.CA/GOVERNMENT/OPEN-GOVERNMENT-LICENCE-ONTARIO](https://www.ontario.ca/government/open-government-licence-ontario)
 PROJECTION: TRANSVERSE MERCATOR DATUM: NAD 83
 COORDINATE SYSTEM: UTM ZONE 17 VERTICAL DATUM: CGVD28



CLIENT
IAMGOLD

PROJECT
CÔTÉ GOLD PROJECT

TITLE
**CÔTÉ PIT LAKE FINAL WATER LEVEL ELEVATION
POST-CLOSURE (STAGE II)**

CONSULTANT	YYYY-MM-DD	2014-11-11
Golder Associates	PREPARED	RRD
	DESIGN	RRD
	REVIEW	NK
	APPROVED	MG

PROJECT No. 1400877 PHASE 10000 Rev. A

FIGURE
5a

Path: Z:\Clam\IAMGOLD\Cote Lake\99 - PROJ\1400877\00 - PROD\CS - Water Resources\1400877-001 - CS-003 - Pit Closure\WaterLevel.mxd

IF THIS MEASUREMENT DOES NOT MATCH WHAT IS SHOWN, THE SHEET SIZE HAS BEEN MODIFIED FROM 24mm





November 10, 2014

IAMGOLD CORPORATION

CÔTÉ GOLD PROJECT

ENVIRONMENTAL
ASSESSMENT REPORT

TECHNICAL SUPPORT
DOCUMENT:
WATER QUALITY

REVISED REPORT

Submitted to:

IAMGOLD Corporation
401 Bay Street, Suite 3200
Toronto, Ontario
M5H 2Y4

Uploaded via Buzzsaw

Report Number: 13-1192-0021R

Distribution:

1 e-copy - IAMGOLD Corporation
1 copy - Golder Associates Ltd.





Executive Summary

IAMGOLD Corporation (IAMGOLD) intends to develop and operate an open pit gold mine and associated facilities and infrastructure in northern Ontario approximately 20 kilometres (km) southwest of Gogama, 130 km southwest of Timmins, and 200 km northwest of Sudbury; this mining project is referred to as the Côté Gold Project (the Project). The landscape is characterized by an extensive tree cover and subdued topography. It is dominated by numerous lakes, streams and wetlands along with extensive bedrock outcrops that are typical of northern Ontario. The area has experienced limited historical mining, and current activities include forestry, mine exploration and some recreational activities.

Baseline sampling programs to characterize the existing surface water and groundwater quality, under a range of flow conditions, were initiated in 2011 and 2012, respectively, with analysis for a variety of parameters, including general parameters, major ions, metals, and nutrients. The existing water quality is typical of the Canadian Shield geological region, with natural weathering processes producing water that is slightly acidic to near-neutral pH, with occasional occurrences of some parameters (including aluminum, copper, iron, phosphorus, zinc, cadmium, lead, silver, thallium and free cyanide) greater than water quality guidelines.

Water quality effects predictions were completed for the construction, operations, closure and post-closure phases of the Project. The post-closure phase was divided into two stages to predict the effects to water quality while the pit is flooding (stage I), and after the pit is flooded, thereby forming the Côté Pit Lake (stage II). The construction and closure phase effects were evaluated qualitatively, while a water quality model was developed to numerically predict water quality effects in the receiving and downstream environments during operations and post-closure for the average, 1:25-year dry and 1:25-year wet conditions. The spatial boundary for the water quality effects predictions is defined by the Project site footprint, adjacent water bodies and downstream extents of watersheds that encompass the Project site, which extends downstream from the Project footprint to the divide between the Great Lakes and James Bay watersheds.

To provide some context for the water quality model results, the predicted monthly average concentrations for the Project-site components (i.e., open pit sump, MRA runoff and seepage, low-grade stockpile runoff and seepage, mine water pond, reclaim pond and polishing pond) are compared to provincial and federal effluent limits and the predicted monthly average concentrations for the surface water receivers are compared to the water quality guidelines. For the purposes of the water quality effects predictions for the surface water receivers, the predicted concentrations were compared to the upper limit of existing conditions (95th percentile baseline concentrations). Where the predicted results exceed the 95th percentile baseline concentrations, the results are then presented against a single set of "Water Quality Guidelines". The set of Water Quality Guidelines are a compilation of the most recent of the Ontario Provincial Water Quality Objectives and Canadian Water Quality Guidelines for each parameter. For parameters where an Ontario Provincial Water Quality Objective or Canadian Water Quality Guideline does not exist, the British Columbia Water Quality Guidelines were considered. The only exception is free cyanide, where a benchmark that is protective of aquatic life (non-salmonids) was used for comparison purposes.

During the construction phase, the Project activities will consist of the development of site infrastructure and associated facilities prior to initiation of open pit mining. Project components, such as the MRA or TMF, are therefore not expected to be developed sufficiently to influence site water quality. However, a key water quality consideration related to construction is erosion and transport of suspended solids into the adjacent surface water



features due to earthworks and other activities that could disturb soil. Best management practices (BMPs) will be implemented to control erosion and sediment transport during construction, to mitigate any project related effects associated with total suspended solids in the surface water receivers.

During the operations phase, the principal Project activities that could affect water quality include: mining of ore from the open pit, storage of mine rock in stockpiles at the Mine Rock Area (MRA), storage of tailings in the Tailings Management Facility (TMF), generation of process water by the process plant, and discharge of treated effluent from the polishing pond. The numerical water quality predictions were based on the fully developed Project site plans with these major features (i.e., open pit, MRA and TMF) modelled at their ultimate extents. The water quality model predictions are therefore conservative with respect to the early years of operations, with effects associated with the ultimate extent of effects not likely to be realized until near the end of the operations phase.

Contact water (i.e., water that has come into contact with mine rock, low-grade ore, the walls of open pit, or the tailings) is predicted to have near-neutral pH, as the geochemistry study suggests that the mine rock and tailings are non-acid generating and contain major ions and metals at concentrations lower than the federal and provincial effluent discharge limits. Contact water from the MRA, low-grade stockpile, and open pit is predicted to contain ammonia and nitrate from the dissolution of residual explosives. Contact water in the TMF will be influenced by process water that is discharged from the cyanide destruction circuit and is expected to contain residual cyanide species, ammonia and metals (i.e., copper).

The water collected from the MRA, low-grade stockpile and open pit reports to the mine water pond, with the surplus pumped to the polishing pond. If not otherwise required for use at the site, treated effluent is discharged to the environment in accordance with metal mining sector effluent discharge regulations. Process water mixes with tailings beach runoff and reports to the reclaim pond where it is recycled back to the process plant. Under normal flow conditions, surplus is not expected in the TMF (i.e., reclaim pond); therefore, the water in the reclaim pond is not pumped to the polishing pond for discharge to the environment.

During the operations phase, and extending through closure and into the post-closure phase, while the pit is flooding (stage I) and following the formation of Côté Pit lake (stage II), monthly average concentrations of major ions and some metals are predicted to be intermittently to continuously greater than the 95th percentile of observed baseline concentrations in lakes in the immediate vicinity of Project facilities and to a lesser extent in downstream lakes in both the Mollie River and Mesomikenda Lake watersheds. Cyanide is also predicted to be greater than baseline concentrations in the Mesomikenda Lake watershed during the operations phase, closure phase and the early stage of post-closure phase, with monthly average concentrations of free cyanide being less than the aquatic benchmark during all Project phases.

Monthly average concentrations of some major ions and metals are predicted to be marginally greater than baseline at the downstream end of the Mollie River watershed (at Dividing Lake) and at the outlet of Mesomikenda Lake during the operations, closure, and post-closure phases. Furthermore, during operations, closure, and to a lesser extent the early stage of post-closure, monthly average cyanide concentrations are expected to be marginally greater than baseline concentrations, but are expected to be less than the aquatic benchmark and Water Quality Guidelines, at the downstream end of the Mesomikenda Lake watershed. The model results suggest that concentrations of some parameters that are marginally greater than baseline conditions may persist within a localized area near the downstream end of the Mollie River and Mesomikenda Lake Watersheds.



During all Project phases, monthly average concentrations of those major ions and metals that are predicted to be greater than the 95th percentile baseline concentrations are less than the Water Quality Guidelines. The only exception is phosphorous, which is predicted to be greater than both the 95th percentile baseline concentrations and the Water Quality Guideline in some lakes during each of the Project phases; noting that the Water Quality Guideline for phosphorous is based on an aesthetic objective and not a guideline that is directly derived from aquatic toxicity data.

Mitigation measures have been incorporated into the design of the Project to reduce effects on water quality. These measures, which were considered in the prediction of effects (i.e., water quality modelling), include:

- construction of engineered facilities to store mine rock (MRA), low-grade ore (low-grade stockpile) and tailings (TMF);
- construction of engineered water management systems to collect runoff and seepage from the MRA, low-grade stockpile, TMF, and polishing pond;
- management of contact water, which is comprised of inflows and runoff from the pit walls, runoff and seepage from the MRA and low-grade stockpiles, and runoff from the plant site, whereby the contact water will be collected and pumped to the mine water pond;
- management of contact and process water contained within the collection ponds adjacent to the TMF and polishing pond by pumping the collected water back into the reclaim pond;
- implementation of erosion and sediment control measures to minimize erosion, promote settling of sediments and mitigate the migration of suspended solids into nearby surface water features; these measures will incorporate BMPs (e.g., use of appropriate earthwork methods, ditching, sediment ponds/traps, channel and slope armouring, vegetation buffers, and sediment fencing);
- treatment of process water at the process plant for cyanide, cyanide destruction constituents (i.e., ammonia and copper) and other dissolved metals prior to discharge into the TMF for recycling back to the processing plant;
- treatment of effluent to meet federal and provincial metal mining sector effluent limits, as required, prior to being discharged from the polishing pond to the environment; and
- implementation of BMPs for explosives and blasting to reduce the blast waste rate and residual explosives available for contact with water.

A monitoring program has been developed to continue the collection of data required to evaluate changes to water quality prior to and during Project implementation (construction, operations, closure and post-closure). The purpose of the monitoring program is to confirm the results of the effects predictions presented herein, and to provide a basis for future decision making regarding the environmental management of the Project. The monitoring plan will include:

- water quality of surface water, groundwater, and contact water from the Project site components, and
- sediment quality of lake and watercourse bottom sediments.

The network of monitoring stations will include existing and new locations on the Project site, which will be positioned upstream and downstream of key Project site components, as required.



Table of Contents

1.0 INTRODUCTION..... 1

1.1 Project Overview..... 1

1.1.1 Open Pit..... 2

1.1.2 Mine Rock Area 2

1.1.3 Low-Grade Stockpile..... 2

1.1.4 Tailings Management Facility..... 2

1.1.5 Processing Plant..... 3

1.1.6 Mine Water Pond and Polishing Pond..... 3

1.1.7 Watercourse Realignments..... 3

1.1.8 Project Site Water Management 4

1.1.9 Domestic Sewage 5

1.1.10 Non-hazardous Landfill 5

2.0 METHODOLOGY..... 5

2.1 Effects on Water Quality 5

2.2 Study Areas (Spatial Boundaries)..... 7

2.2.1 Local Study Area..... 7

2.3 Project Phases (Temporal Boundaries)..... 8

2.4 Selection of Effects Assessment Indicators 9

2.5 Background Review 10

2.6 Field Study Methods 10

2.7 Effects Prediction..... 11

3.0 EXISTING CONDITIONS 13

3.1 General Setting and Drainage Patterns 13

3.2 Surface Water Quality..... 14

3.3 Groundwater Quality..... 16

4.0 PREDICTION OF EFFECTS..... 17

4.1 Effects Assessment Indicator Parameters and Comparison Criteria 18

4.2 Construction Phase 18

4.3 Operations Phase..... 19



TECHNICAL SUPPORT DOCUMENT: WATER QUALITY

4.3.1	Conceptual Model	19
4.3.2	Project Site Components	20
4.3.3	Treated Effluent Discharge Alternatives Analysis	22
4.3.4	Surface Water Receivers	24
4.4	Closure Phase	29
4.5	Post-closure Phase Stage I	29
4.5.1	Conceptual Model	29
4.5.2	Surface Water Receivers	30
4.6	Post-closure Phase Stage II	35
4.6.1	Conceptual Model	35
4.6.2	Surface Water Receivers	35
5.0	MITIGATION AND MONITORING	41
5.1	Mitigation	41
5.2	Monitoring	42
5.2.1	Surface water	42
5.2.2	Groundwater	43
5.2.3	Sediment	44
6.0	CONCLUSIONS	45
7.0	REFERENCES	46

TABLES

Table 2-1: Effects Assessment Indicators Selected for Water Quality	9
Table 2-2: Prediction of Water Quality Effects Locations	12
Table 3-1: Summary of Baseline Surface Water Quality Results	15
Table 3-2: Summary of Baseline Groundwater Quality Results	16
Table 4-1: Monthly Average Concentrations for Project Site Components, Operations Phase	21
Table 4-2: Monthly Average Concentrations for Receiver Options of Treated Effluent, Operations Phase	22
Table 4-3: Monthly Average Concentrations for Locations in Mollie River Watershed, Operations Phase	27
Table 4-4: Monthly Average Concentrations for Locations in Mesomikenda Lake Watershed, Operations Phase	28
Table 4-5: Monthly Average Concentrations for Locations in Mollie River Watershed, Post-closure Phase Stage I	33
Table 4-6: Monthly Average Concentrations for Locations in Mesomikenda Lake Watershed, Post-closure Phase Stage I	34
Table 4-7: Monthly Average Concentrations for Locations in Mollie River Watershed, Post-closure Phase Stage II	39



Table 4-8: Monthly Average Concentrations for Locations in Mesomikenda Lake Watershed, Post-closure Phase Stage II.....	40
---	----

FIGURES

Figure 1-1: Project Location

Figure 1-2: Site Plan

Figure 2-1: Water Quality Local Study Area

Figure 2-2: Surface Water Quality Monitoring Stations

Figure 2-3: Groundwater Quality Monitoring Stations

Figure 2-4: Treated Effluent Discharge Alternatives Analysis: Conceptual Mixing Zones

Figure 2-5: Prediction of Water Quality Effects Locations

APPENDICES

Attachment I

Water Quality Baseline Report, Côté Gold Project

Attachment II

Water Quality Modelling Report, Côté Gold Project



ABBREVIATIONS

°C	degrees Celsius
AMEC	AMEC Environment & Infrastructure
ANFO	Ammonium Nitrate / Fuel Oil
BCMOE	British Columbia Ministry of the Environment
BCWQG	British Columbia Water Quality Guidelines
BMPs	Best Management Practises
CDWQG	Canadian Drinking Water Quality Guidelines
CWQG	Canadian Water Quality Guidelines
EA	Environmental Assessment
EAI	Effects Assessment Indicator
EIS	Environmental Impact Statement
G Mining	G Mining Services Inc
ha	hectare
km	kilometre
LSA	Local Study Area
m	metre
m ²	metres squared
masl	metre above sea level
mg/kg	milligrams per kilogram
mg/L	milligrams per litre
Project	Côté Gold Project
PWQO	Ontario Provincial Water Quality Objectives
MOE	Ontario Ministry of the Environment
MRA	Mine Rock Areas
MTO	Ministry of Transportation
MRSP	Mine Rock Storage Ponds
Mt	Million tonnes
ODWS	Ontario Drinking Water Standards
RSA	Regional Study Area
SSC	Site Specific Criterion
TDSP	Tailing Dam Seepage Ponds
TMF	Tailings Management Facility
TSD	Technical Support Document
WERF	Water Environment Research Foundation



1.0 INTRODUCTION

This Technical Support Document (TSD) was prepared by Golder Associates Ltd. (Golder) and comprises an Appendix of the Environmental Impact Statement (EIS) of the IAMGOLD Corporation (IAMGOLD) Côté Gold Project (the Project). This TSD presents detailed information on the existing conditions and the predicted water quality effects associated with the Project. Predicted effects on water quality have been incorporated into the Aquatic Biology and Human and Terrestrial Ecological Health Risk Assessment TSDs. The significance of the assessed effects of the Project related to water quality and associated disciplines are presented in the main body of the EIS.

1.1 Project Overview

IAMGOLD intends to develop the Côté Gold Project in the District of Sudbury, in northeastern Ontario, approximately 20 kilometres (km) southwest of Gogama, 130 km southwest of Timmins, and 200 km northwest of Sudbury (shown on Figure 1-1). The area is characterized by exposed bedrock, gentle hills, forests, lakes and rivers typical of northern Ontario. The Project site is located on two watersheds defined for this study, the Mollie River system and the Mesomikenda Lake system. Additionally, the watershed divide between the Great Lakes and James Bay watersheds lies about 3.5 km to the southwest of the Project footprint. Land use in the area consists of recreational activities by locals and tourists, including fishing, camping and hunting. It is also used for sustainable harvesting of timber.

IAMGOLD proposes to construct, operate and eventually rehabilitate a new open pit gold mine and ore processing facility with associated infrastructure.

A complete description of proposed Project activities and infrastructure is presented in the main body of the EIS. For the purposes of the water quality TSD, a brief description of the Project components and associated activities that have the potential to affect water quality is presented below and includes:

- blasting, excavation and dewatering of a 550 metre (m) deep open pit mine;
- development of a 450 ha Mine Rock Area (MRA) and associated perimeter runoff and seepage collection facilities;
- temporary storage of low grade ore (low-grade stockpile) located to the northeast of the pit;
- development of a 840 hectare (ha) Tailings Management Facility (TMF), polishing pond and associated perimeter runoff and seepage collection facilities;
- ore beneficiation and discharge of water from the processing plant to the TMF;
- management of site runoff and seepage through the use of collection ponds and a mine water pond located adjacent to the processing plant;
- realignment of various surface water features and construction of associated dams;
- operation of domestic sewage works and treatment system associated with the camp site and plant facilities; and
- deposition of domestic waste into the non-hazardous landfill located about 2.5 km east of the open pit.



The key Project components are presented in Figure 1-2 and are discussed further below.

1.1.1 Open Pit

As part of the proposed development, Côté Lake will be drained and the upstream watershed will be realigned around the open pit, including the requirement for dams at some lakes to redirect water and control seepage in the vicinity of the pit perimeter as further discussed in Section 1.1.7.

The current open pit design proposes a final pit area of approximately 210 ha with a depth of approximately 550 m. Open pit mining will occur at a mining rate of approximately 60,000 tonnes per day of ore production. Extraction of the ore through pit development will result in the production of an estimated 20 million tonnes (Mt) of overburden and 850 Mt of mine rock. Water from the open pit will be pumped to the mine water pond.

1.1.2 Mine Rock Area

The MRA is located approximately 250 m southeast of the open pit and occupies an area of approximately 450 ha. The MRA is bounded by Three Duck Lakes to the east, the open pit (formerly Côté Lake) to the northwest, Chester Lake to the west, and Delaney Lake to the south.

The Mollie River, which flows northward adjacent to this area will be re-aligned to flow into Clam Lake at the west side of the open pit. A forestry access road (Chester Road) traverses the MRA north to south along the western side of the footprint. A portion of this road will need to be relocated.

A series of 15 collection ponds (Mine Rock Storage Ponds; MRSPs) with connecting ditches are to be constructed around the perimeter of the MRA to collect runoff and toe seepage.

1.1.3 Low-Grade Stockpile

Low-grade ore will be stockpiled to the north of the open pit and east of the processing plant, as shown on Figure 1-2. Approximately 2 km of water collection ditches and four storage ponds will be constructed to collect runoff and toe seepage at the perimeter of the stockpiles, with water pumped back to the mine water pond. Perimeter containment berms (where required for the storage ponds) will be constructed with geomembrane liners and protected with non-woven geotextile to prevent seepage losses to the underlying groundwater and adjacent open pit.

1.1.4 Tailings Management Facility

The TMF will have an area of approximately 840 ha and will be designed to store approximately 193 million cubic metres (m³, 261 Mt) of tailings solids. Tailings dams will be constructed primarily with waste rock and comprise approximately 90 percent of the total perimeter length of the TMF. Tailings will be discharged from perimeter containment dams with drainage directed towards a central reclaim pond.

Dam design incorporates approximately 94,200 metres squared (m²) of geomembrane liner protected by a non-woven geotextile cushion layer to minimise seepage losses from the starter dams.



Seepage losses from the TMF and runoff from the tailings dams will be collected at six Tailings Dam Seepage Ponds (TDSPs) and associated ditches located at the downstream toe of the tailings dams, with the collected seepage water pumped back to the reclaim pond. Water collected in the reclaim pond will be recycled for use at the processing plant.

1.1.5 Processing Plant

The ore processing plant will be located to the northwest of the open pit. Ore beneficiation will consist of crushing and grinding, including coarse gold recovery by gravity, cyanide leaching, carbon-in-pulp recovery, followed by carbon stripping and electro-winning. The tailings produced from ore processing, which will contain some residual cyanide and dissolved metals, will be directed to an in-plant cyanide destruction and precipitation circuit. Prior to discharge to the TMF, the process water and tailings will be treated at the process plant for cyanide, dissolved metals and potentially ammonia.

A pipeline delivering tailings slurry at an approximate rate of 56,000 m³/day and a slurry density of approximately 51% solids by mass will result in approximately 35,000 m³/d of supernatant water (water not held in tailings pore space) discharged to the TMF reclaim pond.

1.1.6 Mine Water Pond and Polishing Pond

Contact water from the open pit, the MRA, low-grade stockpile, toe seepage collected at dams in the vicinity of the open pit, and runoff from the area of the processing plant and associated facilities will be directed to the mine water pond. This water will be used for ore processing and other demands such as dust control. The mine water pond design incorporates a high density polyethylene geomembrane liner to prevent seepage losses from the pond to the underlying groundwater table and adjacent open pit.

The polishing pond is located to the north of the TMF. Excess water in the mine water pond will be directed to the polishing pond for additional removal of suspended solids. Subsequently, water in the polishing pond will be pumped back for use at the processing plant, directed to the TMF reclaim pond (when storage is available) or treated effluent will be discharged to the environment in accordance with federal and provincial effluent discharge requirements. Bagsverd Creek and Mesomikenda Lake have both been identified as potential receivers for treated effluent discharged from the polishing pond. Seepage losses from the polishing pond will be collected at seepage ponds and associated ditches at the downstream toe of the containment dam, with the collected seepage water pumped back to the polishing pond.

1.1.7 Watercourse Realignment

The local watercourses and lakes, including flow directions, in the vicinity of the Project are shown in Figure 1-2. The Project will overprint several water features, these include: Côté Lake, and portions of Bagsverd Creek; Bagsverd Lake; Three Duck Lakes; Clam Lake; Chester Lake; and the Mollie River. Project construction requires the realignment of Weeduck Lake, Clam Lake, Un-named Lake #2 and parts of the Mollie River, Bagsverd Creek and Bagsverd Lake.

Watercourse realignments were selected to:



- minimize the overall Project environmental footprint, while at the same time considering economic efficiency of the Project;
- minimize disturbance of the existing water flow regime and existing aquatic habitat, thereby also minimizing disturbance on existing terrestrial flora and fauna;
- minimize disturbance of existing land use; and
- minimize water transfer between the Mollie River and the Mesomikenda Lake watersheds.

Six realignments are planned, totalling approximately 7.9 km of constructed channels.

For surface water flow associated with the Mollie River, the outflow from Chester Lake will be diverted northwards via an approximately 2.2 km long constructed channel to Clam Lake. Flow will be directed northwards along the west side of the open pit to Little Clam Lake and then via a short constructed channel to an existing stream and wetland area that drains eastwards to Bagsverd Lake. The southern portion of Bagsverd Lake will be dammed (and isolated from the larger northern portion) with a constructed channel directing flow southward through Weeduck Lake and Three Duck Lakes.

In the vicinity of the TMF, the northern portion of Bagsverd Lake will be connected to Un-named Lake #2 via an approximately 4.3 km long constructed channel. Flow then discharges east to Un-named Lake #1 and reconnects to Bagsverd Creek immediately north of the TMF.

At closure, the realignment structures are expected to remain in place until such time as the water quality is suitable for release to the environment and the open pit is flooded. At that point in time, it is then envisaged that changes to realignment features will be completed to restore surface water flow paths similar to pre-development conditions.

1.1.8 Project Site Water Management

The construction of Project components outlined above will require active management of on-site water. Briefly, the water management system at the Project site consists of:

- A total process water demand at the processing plant of approximately 56,000 m³/day, of which a minimum of 840 m³/day of freshwater is drawn from Mesomikenda Lake.
- A mine water pond, which will provide the ore processing plant with recycled water collected from runoff and seepage at the MRA, low-grade ore stockpile, open pit dewatering and local runoff collection facilities, or will be discharged to the polishing pond.
- A TMF reclaim pond that receives the water discharged in tailings slurry not retained in pore space (approximately 35,000 m³/day), and recycles reclaim water back to the processing plant.
- A polishing pond that receives water from the mine water pond and is capable of recirculating water to the ore processing plant, the TMF reclaim pond or discharging treated effluent to the environment, when required.



1.1.9 Domestic Sewage

Domestic sewage during the construction and operations phases is expected to be treated prior to release to the environment. Treated effluent from the sewage treatment system will be discharged to the environment through a tile bed system that will provide additional attenuation of nutrients (within and downgradient of the tile bed) prior to discharge to the surface water environment. Alternatively, treated domestic sewage effluent may be combined with other effluent streams prior to discharge. The treated sewage discharge will meet federal and provincial treated sewage discharge requirements.

1.1.10 Non-hazardous Landfill

Non-hazardous solid wastes, comprising food scraps, refuse, clothing, metal tins, scrap metal, glass, plastic, wood, paper and similar materials, may be stored in a dedicated landfill located near, or on the Project site, which would be under IAMGOLD care and control. Alternatively, non-hazardous solid wastes may be temporarily stored on the Project site for subsequent transport to an off-site licensed landfill, which would be under the care and control of a third party.

2.0 METHODOLOGY

The prediction of Project related effects on water quality includes the following tasks, which are further described in following sections:

- identify the Project activities that could potentially effect water quality;
- define the spatial and temporal boundaries over which the effects prediction is to be conducted;
- select prediction indicators for water quality effects;
- characterize the existing water quality conditions of the area; and
- predict changes in water quality.

2.1 Effects on Water Quality

A description of the Project is presented in the EIS, including concepts to develop the open pit, handle and store mine rock and low-grade ore, and to manage water at the site. The locations of the primary Project components are provided on Figure 1-2. Some Project components, or the activities or processes associated with those Project components, have the potential to have an effect water quality as described below:

- Open pit – The excavation of mine rock and the development of the open pit results in the rock face of the pit walls being exposed to atmospheric conditions. The blasting of the rock typically results in a “damaged zone” of rock that consists of shallow fractures that extend into the bedrock from the face of the pit wall. The surfaces of the fractures in the damaged zone are also exposed to atmospheric conditions. The exposed rock surfaces are susceptible to weathering processes that can lead to the mobilization of constituents through oxidation and dissolution reactions. Water that comes into contact with the exposed rock surfaces (i.e., direct precipitation, groundwater inflow and runoff from the open pit catchment area) can



therefore transport soluble constituents into the pit sump and affect its water quality. Because the mine water in the pit sump is pumped to the mine water pond and then to the polishing pond, the weathering of exposed rock surfaces in the pit can affect the water quality in the mine water pond and polishing pond.

- MRA and low-grade stockpile – The storage of mine rock and low-grade ore in the MRA and low-grade stockpile, respectively, results in exposure to atmospheric conditions. The exposed rock surfaces, in particular the fine grained portions, are susceptible to weathering processes that can lead to the mobilization of constituents through oxidation and dissolution reactions. Water that infiltrates into the MRA and low-grade stockpile can interact with the weathered rock surfaces and mobilize constituents that are by-products of mine rock oxidation. The runoff and seepage water that is collected at the MRSPs will therefore be influenced by the constituents that are mobilized from the mine rock through weathering processes. Because the water in the MRSPs is pumped to the mine water pond and then to the polishing pond, the weathering of mine rock in the MRA and low-grade ore in the low-grade stockpile can affect the water quality in the mine water pond and polishing pond.
- Explosives use - Explosive agents, including ammonium nitrate/fuel oil (ANFO) and emulsion, will be used during mining of the open pit. The detonation of explosives, and the consumption of its agents, is not 100% efficient; this results in the presence of undetonated blasting residues within mine rock, low-grade ore and within the open pit. The explosive residues contain nitrate and ammonia, which are soluble and can be mobilized upon contact with water. As such, the MRA, low-grade stockpile and open pit are sources of nitrate and ammonia that may have effects on water quality.
- TMF – Tailings are produced as part of ore processing and will be stored in the TMA, which is a subaerial facility. The subaerial deposition of tailings results in exposure to atmospheric conditions, and the tailings are therefore susceptible to weathering processes, such as oxidation and dissolution reactions. Runoff across the surface of the tailings and seepage water that infiltrates through the tailings pore space can mobilize constituents that are by-products of tailings oxidation. The runoff that reports to the reclaim pond and seepage water that is collected at the TDSPs will be influenced by the constituents that are leached from the tailings.
- Process water – Ore beneficiation for the Project includes the use of cyanidation to extract the gold, which produces cyanide-bearing process water. The process water containing cyanide will report to a cyanide destruction circuit prior to being discharged to the TMF. However, some residual cyanide, by-products of the cyanide destruction process, and other metals will remain in the process water that is discharged into the TMF. The process water in the TMF will make-up part of the water in the reclaim pond. Furthermore, process water retained in tailings pore space will migrate out of the TMF as seepage. The chemistry of the process water will therefore affect water quality of the reclaim pond and seepage that is collected in the TDSPs and pumped back to the reclaim pond.
- Treated effluent discharge – Excess water from the mine water pond will report to the polishing pond. During periods when there is excess water in the polishing pond and storage available in the TMF, water will be pumped from the polishing pond to the reclaim pond. However, during periods when there is excess water in the polishing pond and no available storage in the TMF, the excess water (i.e., treated effluent) in the polishing pond will be discharged to the environment, according to federal and provincial metal mining sector effluent discharge requirements and regulations. The discharge of treated effluent has the potential to affect water quality of the receiving and downstream surface water bodies.



- **Treated sewage discharge** - Domestic sewage will be conveyed to a treatment system to produce water of a quality that is suitable for direct discharge to the environment, in accordance with federal and provincial sewage effluent discharge requirements. Treated domestic sewage effluent will be either directly discharged to the environment after being passed through a treatment system, or combined with other effluent streams prior to discharge. Because the domestic sewage effluent will be treated to meet federal and provincial sewage effluent limits and aquatic guidelines, as required, the discharge of treated sewage effluent directly to the environment is unlikely to have an effect on water quality. As such, the discharge of treated domestic sewage effluent is not considered further in the water quality effects predictions.
- **Non-hazardous landfill** – It is currently planned that non-hazardous domestic and industrial solid waste will be disposed of in an existing nearby landfill. IAMGOLD will take responsibility of an existing landfill and operate the landfill in accordance with federal and provincial legislative requirements. Best management practises (BMPs) will be integrated into the operation and closure of the landfill to ensure that the Project's use of the landfill will not affect water quality; for example, the management of the landfill will include mitigation, monitoring, remedial action and closure plans. Remedial action plans, such as collection and treatment, will be executed if monitoring identifies the potential for an adverse effect on water quality. Closure plans will be executed upon entering the closure phase of the Project. As the management of the landfill will include mitigation, monitoring and remediation, as required, and follow federal and provincial legislative requirements, the non-hazardous landfill is not considered further in the water quality effects predictions.

2.2 Study Areas (Spatial Boundaries)

The water quality study areas define the spatial boundaries within which the physical works and activities of the Project could potentially affect water quality. One study area has been selected for the prediction of Project-related effects on water quality: the Local Study Area (LSA). The LSA is discussed in Section 2.2.1. Effects on water quality are not expected to greatly extend beyond the watersheds encompassed by the LSA; as such, a Regional Study Area (RSA) has not been defined for water quality for this EA.

2.2.1 Local Study Area

The LSA includes an area beyond the location of the physical works and activities within which effects may occur as a result of the Project. For water quality, the LSA is defined by lakes and watersheds in the vicinity and downstream of the Project infrastructure and covers an area of approximately 22,100 ha. The LSA boundary encompasses the lakes that are included as part of the water quality baseline and prediction of effects. As the water quality predictions are dependent on the flow of water, the Water Quality LSA is coincident with the Hydrology LSA.

The LSA is bounded by the following features:

- the Great Lakes/James Bay watershed divide along the south and southwest;
- the Chester Lake and Bagsverd Lake inflow to the west;
- Mesomikenda Lake to the east; and



- the Somme River system associated with the Neville Lake Watershed to the north and northwest.

The water quality LSA is shown on Figure 2-1.

2.3 Project Phases (Temporal Boundaries)

The temporal boundaries of the EA will span all phases of the Project:

- construction;
- operations;
- closure; and
- post-closure.

Each of the Project phases was considered as part of the water quality effects predictions as follows:

- Construction phase: This phase will consist of building the site infrastructure and associated facilities prior to the initiation of mining and ore beneficiation. As such, the Project-site components will be in the process of being developed, and are not expected to influence site water quality during this time. Therefore, numerical predictions using water quality modelling were not completed for the construction phase; rather, the water quality effects predictions for the construction phase is discussed qualitatively herein.
- Operations phase: This phase will be initiated upon the start of ore extraction and processing, and will cease once the economical ore reserves have been depleted. During the operations phase, the potential effects on water quality are expected to be greatest at the end of mining when the open pit, TMF, MRA and low-grade stockpile are fully developed and have reached their ultimate extents. Therefore, numerical predictions of potential effects on water quality were completed using a water quality model concept based on fully developed Project components that are assumed to exist at the end of mine life.
- Closure phase: This phase will consist of closure of the Project site, as presented in the Conceptual Closure Plan (see EIS report). Water quality benefits of closure works in some cases are not expected to have an immediate effect and benefits may not be realized until sometime during the post-closure phase. As such, for the purposes of the water quality effects predictions, numerical estimates using water quality modelling were not completed for the closure phase; rather, the water quality effects predictions assume that the predicted effects on water quality during the operations phase will continue during the construction phase, and are discussed qualitatively herein.
- Post-closure phase: This phase consists of the period after the closure works have been completed. The potential effects that Project closure works have on water quality will likely be largely realized during the post-closure phase. Numerical predictions of potential effects on water quality during post-closure were therefore completed using a water quality model concept based on the decommissioned and rehabilitated fully developed Project components. The post-closure phase was further divided into two stages to evaluate the effects to water quality during post-closure when the pit is flooding (stage I), and after the pit is completely flooded and has formed the Côté Pit Lake (stage II).



2.4 Selection of Effects Assessment Indicators

The effects assessment indicator (EAI) selected for water quality and the rationale for selection of this indicator are presented in Table 2-1.

Table 2-1: Effects Assessment Indicators Selected for Water Quality

Effect Assessment Indicator	Rationale for Selection
Changes in surface water quality	Project activities, particularly effluent discharge, have the potential to affect receiving water quality.

Surface water quality was identified as the EAI for project-related effects on water quality. This EAI was identified as important, based on feedback received from consultation and engagement activities conducted by IAMGOLD. Some Project components, or activities and processes associated with those Project components, have the potential to affect surface water quality, as discussed in Section 2.1; as such, the focus of the water quality assessment was on potential changes to surface water quality.

The water quality effects prediction does not explicitly consider changes to groundwater quality. Groundwater at the Project site is not expected to be used as a source of drinking water, and if so, it is assumed that any potential use of groundwater as a drinking water supply would include proper treatment. Near surface groundwater (in the overburden) discharges locally to surface water or swampy low-land areas and overburden aquifer material is discontinuous and surrounded by bedrock outcrops (see Hydrogeology TSD). Since groundwater discharges locally to surface water, or is collected at the sump in the open pit or at seepage collection ponds at the MRA and low-grade stockpile, the various interactions of the Project that affect groundwater quality were integrated into the surface water quality assessment, as required. This allows for the water quality assessment to predict the net or combined effect on surface water quality.

Predictions of potential effects on sediment quality due to the Project have not been completed, but are however implicitly considered through the water quality effects predictions and mitigation planning. Changes to sediment quality can be a result of: 1) geochemical processes that form precipitates directly on the sediments, or colloids in the water column that become part of the sediments through sedimentation and settling processes, and 2) discharge of a suspended solid load that results in the accumulation of mineral grains over the existing sediments. Effects to sediment quality that are caused by geochemical processes will depend on changes to water quality, and only significant changes to water quality will result in significant changes to sediment quality. Since changes to surface water quality are the key focus of the water quality predictions, changes to sediment quality through these geochemical processes are implicitly considered. Changes to sediment quality due to accumulations of suspended solids are due to geomorphic processes, such as erosion and sediment transport. Because engineered measures and BMPs will be implemented to control erosion and the physical transport of sediments on the Project site, and because the treated effluent discharged from the site will meet federal and provincial metal mining sector effluent discharge requirements and regulations, including those pertinent to total suspended solids, any suspended solids discharged from the Project site are expected to have a negligible effect on sediment quality.



2.5 Background Review

Available information was reviewed including previous reports, base mapping, bathymetric data, Ontario Ministry of the Environment (MOE) Water Well Records and Permit to Take Water databases, exploration data from IAMGOLD, and information provided by IAMGOLD. Based on this review, a site inspection and understanding of the Project Description, a field program was developed and implemented to characterise the existing water quality conditions at the Project, as outlined in Section 2.6.

2.6 Field Study Methods

Surface water and groundwater sampling programs were developed, carried out and are ongoing to characterize the existing (baseline) water quality conditions; these sampling programs have been completed by IAMGOLD and Golder personnel. Surface water sampling began in September 2011 at select stations; as additional information became available, supplementary surface water quality stations were added to the program during 2012 and 2013. In total, surface water quality samples have been collected at 22 watercourse and 12 lake profile stations within the LSA (Figure 2-2). The locations of the stations were selected to cover conditions upstream and downstream of the Project footprint and associated Project components. The frequency of sampling events has been completed on a quarterly to monthly basis, depending on the station location, to measure the water quality within the LSA under a range of flow conditions.

Groundwater sampling has been completed at 37 locations consisting of paired or single monitoring wells within the LSA (Figure 2-3). In 2012, groundwater sampling consisted of three campaigns to capture a range of climatic conditions at the Project site: spring (May-June), summer (August) and fall (November-December). The 2013 groundwater quality samples were collected at a subset of 27 locations during the spring (June), summer (August/September) and fall (October/November); noting that only 2012 groundwater quality data is presented in the water quality baseline report (Attachment I), as the 2013 data was not available in time to be included into the prediction of effects.

Samples of surface water and groundwater were submitted to certified analytical laboratories for water quality analysis. Samples collected for the water quality baseline study were analyzed for a variety of parameters, including: general or physiochemical parameters, major ions, metals, nutrients, and organics (oil and grease, polycyclic aromatic hydrocarbons, polychlorinated biphenyls). The following guidelines and standards were used to assist with the selection of water quality analytes:

- Ontario Provincial Water Quality Objectives (PWQOs) (MOEE 1999);
- Canadian Water Quality Guidelines (CWQGs) (CCME 2013);
- Ontario Drinking Water Standards (ODWSs) (MOE 2003); and
- Canadian Drinking Water Quality Guidelines (CDWQGs) (Health Canada 2012).

Method detection limits (MDLs) for the water quality analyses were generally selected to be lower than PWQOs, CWQGs, ODWSs and CDWQGs. However, this is not always the case, in particular for parameters with CWQGs that depend on other parameters (i.e., hardness); in these instances, lower MDLs were requested for select sampling rounds to establish the lower range of the concentrations.



The field study methods for the water quality baseline program are detailed in Attachment I.

In addition to the baseline water quality field studies, the hydrology and geochemistry studies include results of field studies of surface water flow and mine rock geochemical characteristics, respectively, which are important contributors to the water quality predictions. The field study methods of the hydrology and geochemistry programs are presented in the Hydrology and Climate TSD and Geochemical Characterization Report, respectively.

2.7 Effects Prediction

The water quality effects predictions were completed qualitatively or using a water quality model to estimate the water quality at key site components and potential changes to the water quality of the receiving and downstream environments. A deterministic water quality model was developed for the Project using GoldSim Version 10.5. GoldSim is a graphical, object-oriented mathematical model where all input parameters and functions are defined by the user and are built as individual objects or elements linked together by mathematical expressions. The object-based nature of the model is designed to facilitate understanding of the various factors that influence an engineered or natural system and predict the future performance of the system.

The modelling approach used for the water quality predictions is a mass-balance mixing cell model that consists of a number of site-specific components, consisting of both natural components (e.g., precipitation) and Project-site components (e.g., treated effluent discharge), that are linked together to form a series of mixing cells. Each mixing cell has two or more sources of mass load that are combined to determine a “mixed” or combined water quality. The water quality model was constructed by building upon the hydrology GoldSim model, whereby geochemistry and baseline water quality inputs were integrated with flow rates (the water balance) to calculate mass loading rates. The flow logic, which forms the basis of the water balance, is used to configure the model linkages, including determining the direction of mass movement along the flow paths and defining the location of mass mixing points. The flow rates were used with the water quality inputs to derive mass loading rates for each of the model components. The modelling approach, methods, assumptions and limitations are discussed in the Water Quality Modelling Report (see Attachment II).

As discussed in Section 2.1, water quality can potentially be affected by a number of Project-related components and activities. The objective of the water quality modelling is to predict the net combined effect that the Project components/activities may have on the quality of the surface water environment during the different Project phases. The predictions of potential effects on water quality focused on two Project phases under four scenarios:

- 1) **Operations Phase – Bagsverd Creek Treated Effluent Discharge Option:** This scenario was modelled to simulate surface water quality conditions assuming treated effluent would be discharged at the downstream end of Bagsverd Creek. It is assumed that the lower basin of Neville Lake will be used as a mixing zone, with the downstream end of the mixing zone being the Neville Lake outflow (Figure 2-4).
- 2) **Operations Phase – Mesomikenda Lake Effluent Discharge Option:** This scenario was modelled to simulate surface water quality conditions assuming treated effluent would be discharged to the upper-middle basin of Mesomikenda Lake. It is assumed that the upper-middle basin of Mesomikenda Lake will



be used as a mixing zone, with the downstream end of the mixing zone being the outflow to the upper basin of Mesomikenda Lake (Figure 2-4).

- 3) **Post-closure Phase Stage I:** This scenario was modelled to simulate surface water quality conditions following closure of the Project components, during the period in which the pit is flooding (i.e., no discharge from the open pit).
- 4) **Post-closure Phase Stage II:** This scenario was modelled to simulate surface water quality conditions when the open pit is completely flooded and assimilated within the receiving environment (i.e., the Mollie River system).

Each of the above four scenarios were modelled for three climate conditions: the annual average, dry and wet conditions. Return periods of 25 years were used to derive the water quality predictions for the dry and wet conditions. Modelling the operations and post-closure phases for the three climate conditions provides a framework for the range of expected site and receiving surface water qualities.

Water quality predictions were completed for Project site components that have the potential to affect the overall site water quality; these comprise the: open pit sump, MRA runoff and seepage, low-grade stockpile runoff and seepage, mine water pond, reclaim pond and polishing pond. During the operations phase, treated effluent will be discharged from the polishing pond, the quality of which will strongly reflect a combination of water from the open pit sump, MRA runoff and seepage, and low-grade stockpile runoff and seepage, as these flows are directed to the polishing pond through the mine water pond. Effluent discharges from the site are to meet the provincial metal mining sector effluent limits (as per Schedule 1 of Ontario Regulation 560/94 under the *Environmental Protection Act*) and the federal MMER limits (as per Schedule 4 of the MMER under the *Fisheries Act*, Government of Canada 2013). For the purposes of comparison and evaluating the overall site water quality, the predicted water qualities of the Project site components are compared to the provincial and federal effluent limits.

Predicted effects on receiving environment surface water quality were simulated at the locations presented in Table 2-2 and shown on Figure 2-5. For each watershed, the locations on Table 2-2 below are ordered from upstream to downstream.

Table 2-2: Prediction of Water Quality Effects Locations

Location	Rationale for Selection
<i>Mollie River Watershed</i>	
Chester Lake	Located within Project site boundaries, adjacent to MRA
Clam Lake	Located within Project site boundaries, downstream of Chester Lake ⁽¹⁾
Little Clam Lake	Located within Project site boundaries, downstream of Clam Lake ⁽¹⁾
Bagsverd Lake (south)	Located within Project site boundaries, segregated from main part of Bagsverd Lake, downstream of Little Clam Lake
Weeduck Lake	Located within Project site boundaries, downstream of Bagsverd Lake (south) ⁽¹⁾
Three Duck Lakes (upper/middle)	Located within Project site boundaries, downstream of Weeduck Lake, adjacent to MRA, downstream of Côté Pit Lake ⁽²⁾
Three Duck Lakes (lower)	Located within Project site boundaries, downstream of Three Duck Lake (upper/middle), adjacent to MRA



Location	Rationale for Selection
Delaney Lake	Located within Project site boundaries, adjacent to MRA
Dividing Lake	Located downstream of Three Duck Lakes, Delaney Lake, most-downstream end of the Mollie River Watershed
<i>Mesomikenda Lake Watershed</i>	
Bagsverd Lake	Located within Project boundaries, adjacent to TMF
Un-named Lake #1	Located within Project boundaries, adjacent to TMF
Bagsverd Creek	Downstream of TMF, upstream of Bagsverd Creek treated effluent discharge point
Neville Lake (lower) ⁽³⁾	Downstream of Bagsverd Creek treated effluent discharge point, mixing zone
Neville Lake ⁽⁴⁾	Downstream of Bagsverd Creek
Mesomikenda Lake (upper/middle) ⁽⁵⁾	Contains Mesomikenda treated effluent discharge point, mixing zone
Mesomikenda Lake (upper)	Downstream of both options for treated effluent discharge, most-downstream end of the Mesomikenda Lake Watershed

Notes:

- (1) During operations phase and post-closure phase stage I only.
- (2) Downstream of Côté Pit Lake during post-closure phase stage II only.
- (3) Modelled for operations phase, Bagsverd Creek treated effluent discharge option only. "Neville Lake (lower)" refers to the lower basin of Neville Lake only, and not the entire lake.
- (4) Refers to entire extent of Neville Lake; modelled for operations phase, Mesomikenda Lake treated effluent discharge option, and post-closure phase stages I and II.
- (5) Modelled for operations phase, Mesomikenda Lake treated effluent discharge option only.

Project effects on water quality are not expected to occur in water bodies that are located upstream of the Project footprint; as such, the prediction of changes to water quality are limited to the key water features that are within and directly downgradient/downstream of the Project footprint (as listed in Table 2-2). The Mollie River itself was not explicitly evaluated as a location; however, eight lakes located along the length of the Mollie River system (Chester Lake through Dividing Lake) were modelled and allow for the evaluation of the potential water quality effects to the Mollie River system.

3.0 EXISTING CONDITIONS

The existing environmental conditions at the Project site are described in this section, with a focus on aspects that are pertinent to water quality. The general setting characteristics of the region where the Project is located is presented, along with summaries of the key results from the surface water and groundwater baselines studies. The full results and detailed analysis of the water quality baseline study are presented in Attachment I.

3.1 General Setting and Drainage Patterns

The landscape in the Project area displays relatively subdued topography dominated by rocky knobs interspersed with shallow bedrock-rimmed lakes, streams and wetlands (bogs and fens) in adjacent low-lying areas. Topographic highs are typically comprised of exposed bedrock or a veneer of granular soil covered with mixed boreal forest. Low-lying areas are often poorly drained bogs and fens with surficial peat deposits. Elevations at the Project site range from about 350 masl to 410 masl.



The Project is located approximately 3.5 km north of the Great Lakes/James Bay watershed divide. Drainage pathways from the Project site fall within either 1) the Mesomikenda Lake Watershed, or 2) the Mollie River Watershed. Drainage within the Mesomikenda Lake Watershed flows to the north then northeast to Mesomikenda Lake. Drainage within the Mollie River Watershed first flows to the north, then wraps around toward the east and then southeast to Dividing Lake. The flows from both the Mesomikenda Lake Watershed and Mollie River Watershed eventually report to Minisinakwa Lake and subsequently to the Mattagami River. Located in the Boreal Shield ecozone of Ontario, the climate of the Project site is characterized by cold winters (-10°C to -35°C) and warm summers (10°C to 35°C).

A number of lakes, connected by relatively short streams, are present on the Project site; these lakes are typically shallow (commonly less than 10 m deep) with bedrock-lined shorelines. The Mollie River is fed by Chester and Clam Lakes to the west and flows through the open pit footprint and Côté Lake. The Mollie River system then continues through Three Duck Lakes that consists of three basins: upper, middle and lower. Lake elevations decrease from about 386 metres above sea level (masl) at Clam Lake to the west to 381 masl at the Three Duck Lakes reflecting the low topographic gradient eastwards across the area of the proposed open pit. Outflow from Three Duck Lakes then continues southward through the Mollie River system and merges with drainage from Delaney Lake. The downstream end of the Mollie River Watershed is marked by Dividing Lake.

To the north of the pit footprint, Bagsverd Lake drains northward through Bagsverd Creek and merges with drainage from Un-named Lake #1. Bagsverd Creek continues to flow north and then around a bend to the east and into Neville Lake. The outflow of Neville Lake discharges into Mesomikenda Lake, which consists of four general basins that are referred to as lower, middle, upper/middle and upper. The downstream end of the Mesomikenda Lake Watershed is marked by the upper basin of Mesomikenda Lake.

3.2 Surface Water Quality

To assist with the interpretation of the surface water quality baseline data, the analytical results were compared to PWQOs, CWQGs and ODWSs. Total metal concentrations were compared to the water quality standards and guidelines, with the exception of aluminum that is presented as dissolved ('clay-free') concentrations. Discussion related to comparisons with the ODWSs relates specifically to health-related parameters (Maximum Acceptable Concentration [MAC] or Interim Maximum Acceptable Concentration [IMAC]). For parameters where guidelines are dependent on pH and hardness, an assumed pH of 7 and hardness of 30 mg/L as CaCO₃ was applied. It should be noted that the comparisons to PWQOs and CWQGs are used in this baseline report for screening purposes and to provide a means to interpret the magnitudes of concentrations measured to characterize the existing conditions; these comparisons are not directly linked to the effects prediction.

A summary of the surface water quality results with the number and percentages of samples greater than the PWQOs and CWQGs are presented in Table 3-1; noting that the parameters included in the table were only those observed to have at least one sample greater than the PWQOs or CWQGs and all surface water analyses were less than the ODWS MACs and IMACs. The surface water stations where the concentrations were observed to be greater than PWQOs and CWQGs, and concentrations were measured for the full suite of the analytes can be found in Attachment I.



Table 3-1: Summary of Baseline Surface Water Quality Results

Parameter	Guidelines ⁽¹⁾		Total Number	Sample Values not Meeting Guidelines			
	CWQG	PWQO		CWQG		PWQO	
				Number	Percent	Number	Percent
<i>Watercourse Stations</i>							
Field pH	6.5-9	6.5-8.5	215	22	10	22	10
Dissolved Aluminum	0.1	0.075	241	23	9	50	21
Copper	0.002	0.005	241	19	8	-	-
Iron	0.3	0.3	241	31	13	31	13
Total Phosphorous	0.02	0.02	241	65	27	65	27
Zinc	0.03	0.02	241	30	12	41	17
Cadmium	0.000058	0.0001	241	1	<1	1	<1
Lead	0.001	0.003	241	1	<1	-	-
Silver	0.0001	0.0001	241	1	<1	1	<1
Thallium	0.0008	0.0003	241	-	-	1	<1
<i>Lake Profile Stations</i>							
Field pH	6.5-9	6.5-8.5	22	3	14	3	14
Dissolved Aluminum	0.1	0.075	22	3	14	11	50
Zinc	0.03	0.02	22	2	9	3	14
Cadmium	0.000058	0.0001	22	1	4	-	-
Free Cyanide	0.005	0.005	22	1	4	1	4

Note:

(1) Units for the Canadian Water Quality Guidelines (CWQGs) and Ontario Provincial Water Quality Objectives (PWQOs) are mg/L, except for field and lab pH values, which are unitless.

The baseline surface water quality at the stations monitored can generally be characterized as having acidic to near-neutral pH, with occasional naturally occurring concentrations above the CWQG and PWQO for the following parameters: aluminum, copper, iron, phosphorus (total), zinc, cadmium, lead, silver, thallium and cyanide (free). Surface water concentrations of other parameters analyzed were less than the PWQOs and CWQGs, and all concentrations of parameters analyzed were less than the ODWS MACs and IMACs. The occasional surface water concentrations that were observed to be greater than PWQOs and CWQGs, and the general surface water quality observed in the LSA, are typical of lakes and watercourses that are present within shield terrain (i.e., Canadian Shield geological region). Drainage within these types of geological and hydrological settings is strongly controlled by bedrock outcrops that generate irregular drainage patterns. As such, the occasional concentrations greater than aquatic guidelines likely reflect the influence on surface water quality by natural bedrock weathering processes.



The water column profiling was completed in May and August of 2013 to evaluate the potential for thermal and chemical stratification within key lakes across the study area. The profiles of dissolved oxygen, temperature, and to a lesser extent conductivity, indicate that the water column is stratified during mid- to late-spring and throughout the summer months. Comparisons between the profiles collected in May 2013 versus those collected in August show that the stratified conditions were less evident during May 2013; suggesting that some of the lakes experienced turnover during the spring of 2013 and were in the process of transitioning to the fully stratified conditions that were observed during the summer.

3.3 Groundwater Quality

As with surface water quality, the interpretation of the groundwater quality analytical results was assisted through comparisons to PWQOs, CWQGs and ODWSs. Although PWQOs and CWQGs are not intended to be compared to groundwater quality results, as these are surface water or aquatic quality guidelines, these comparisons provide insights (at a screening level) regarding the magnitude of concentrations present in the groundwater samples. The dissolved (filtered) metal concentrations, rather than the total concentrations, were measured in the samples of groundwater and were compared to the CWQGs and PWQOs. The dissolved concentrations of metals are more relevant to groundwater because the total concentrations in groundwater samples includes the proportion of metals within solids that are present within groundwater samples; these solids do not flow through most subsurface environments.

A summary of the groundwater quality results with the number and percentages of samples greater than the PWQOs, CWQGs and ODWSs are presented in Table 3-2; noting that the parameters included in the table were only those observed to have at least one sample greater than the PWQOs or CWQGs. The groundwater quality stations where the concentrations were observed to be greater than PWQOs, CWQGs and ODWSs, and concentrations measured for the full suite of the analytes can be found in Attachment I.

Table 3-2: Summary of Baseline Groundwater Quality Results

Parameter	Guidelines ⁽¹⁾			Total No.	Sample Values not Meeting Guidelines					
	ODWS	CWQG	PWQO		ODWS		CWQG		PWQO	
					Number	Percent	Number	Percent	Number	Percent
Field pH	-	6.5-9	6.5-8.5	105	-	-	23	22	23	22
Total Suspended Solids	-	25	-	106	-	-	106	100	-	-
Aluminum	-	0.1	0.075	106	-	-	17	16	19	18
Arsenic	0.025	0.005	0.005	106	1	<1	7	7	7	7
Cadmium	0.005	0.000058	0.0001	106	-	-	10	9	3	3
Chromium	0.05	0.0089	0.0089	106	-	-	3	3	3	3
Cobalt	-	-	0.0009	106	-	-	-	-	6	6
Copper	-	0.002	0.005	106	-	-	25	23	9	8
Iron	-	0.3	0.3	106	-	-	23	22	23	22



Parameter	Guidelines ⁽¹⁾			Total No.	Sample Values not Meeting Guidelines					
	ODWS	CWQG	PWQO		ODWS		CWQG		PWQO	
					Number	Percent	Number	Percent	Number	Percent
Molybdenum	-	0.073	0.040	106	-	-	5	5	9	8
Silver	-	0.0001	0.0001	106	-	-	4	4	4	4
Tungsten	-	-	0.03	106	-	-	-	-	22	21
Uranium	0.020	0.015	0.005	106	1	<1	2	2	10	9
Vanadium	-	-	0.006	106	-	-	-	-	2	2
Zinc	-	0.030	0.020	106	-	-	32	30	39	37
Un-ionized Ammonia	-	0.019	0.020	101	-	-	1	1	1	1
Free Cyanide	0.2	0.005	0.005	106	-	-	3	3	3	3

Note:

(1) Units for the Canadian Water Quality Guidelines (CWQGs) and Ontario Provincial Water Quality Objectives (PWQOs) are mg/L, except for field pH values, which are unitless. The CWQG for cadmium is a draft guideline.

The baseline groundwater quality can be generally characterized as having acidic to near-neutral pH, with occasional concentrations above the CWQG and PWQO for the following parameters: aluminum, arsenic, cadmium, chromium, cobalt, copper, iron, molybdenum, silver, tungsten, uranium, vanadium, zinc, un-ionized ammonia and free cyanide. The following parameter concentrations were occasionally above the ODWS MAC: arsenic and uranium. Concentrations of other parameters analyzed were less than the ODWS MACs/IMACs, PWQOs and CWQGs. For some metals, the concentrations in groundwater were greater than those observed for surface water; this is expected as groundwater experiences a greater degree of water-rock interaction, as compared to surface water, and is therefore more influenced by natural weathering processes in the subsurface. The occasional naturally occurring groundwater concentrations that were observed to be greater than aquatic and drinking water guidelines is not uncommon for shield regions, in particular those with known mineralization.

4.0 PREDICTION OF EFFECTS

The prediction of water quality effects was completed for the construction, operations, closure and post-closure phases of the Project using a combination of qualitative analyses and numerical modelling. The effects predictions for the construction phase were evaluated qualitatively, since the water quality concerns during this phase are largely related to earth works and the control of suspended sediment. A numerical model was used to estimate the water quality at key site components and potential changes to the quality of the receiving and downstream surface water environment during the operations phase. These water quality model results were also conservatively applied to the closure phase, as improvements to water quality due to closure work would be largely realized sometime after the start of the closure phase. Numerical models were also used to predict water quality effects during stage I and II of the post-closure phase.

The predictions of potential effects for each Project phase, as determined by the qualitative analysis and numerical modelling, are presented in the following sections. The results discussion for the operations and post-closure phases begin with a description of the conceptual models that form the basis of the numerical models.



The results discussion for the operation phase also includes water quality predictions for the Project site components, an alternatives analysis for the two treated effluent discharge options, and the effects predictions for the locations in the receiving surface water environment. After the closure phase of the Project, the Project site components will be decommissioned and closed out; as such, the results for the post-closure phases focus on effects predictions for the receiving surface water environment, and not the Project site components. A set of EAI parameters were selected and the water quality model results for the operations and post-closure phases were compared to federal and provincial water quality limits and guidelines.

4.1 Effects Assessment Indicator Parameters and Comparison Criteria

A set of EAI parameters was selected for the prediction of effects as follows: aluminum, ammonia (total), ammonia (un-ionized), antimony, arsenic, barium, boron, cadmium, calcium, chloride, cobalt, copper, cyanide (total), cyanide (free), iron, lead, magnesium, manganese, molybdenum, nickel, nitrate, phosphorous (total), potassium, sodium, strontium, sulphate, uranium, vanadium and zinc. Some parameters, such as pH, alkalinity, total suspended solids, were not included in the prediction of effects; the Water Quality Modelling Report (see Attachment II) includes a discussion, including technical rationale, on the parameters that were not modelled as part of the prediction of potential effects.

To provide some context for the water quality model results, the predicted monthly average concentrations of the above listed parameters are compared to effluent limits or water quality guidelines. For the purposes of the site water quality predictions, the simulated water qualities of the Project-site components (i.e., open pit sump, MRA runoff and seepage, low-grade stockpile runoff and seepage, mine water pond, reclaim pond and polishing pond) are compared to the provincial and federal effluent limits. For the purposes of the effects predictions for the water quality in the surface water receivers, the simulated concentrations of the above listed parameters are compared to the upper limit of existing conditions (95th percentile baseline concentrations). Where the predicted results exceed the 95th percentile baseline concentrations, the results are then presented against a single set of “Water Quality Guidelines”. The set of Water Quality Guidelines are a compilation of the most recent of the PWQOs or CWQGs for each parameter, and for parameters where a guideline value does not exist, the British Columbia Water Quality Guidelines (BCWQGs; BCMOE 2013) were considered. The only exception is free cyanide, where a benchmark that is protective of aquatic life (excluding salmonids) of 0.0098 mg/L was derived from the Water Environment Research Foundation (WERF) document titled: *Scientific Review of Cyanide Ecotoxicology and Evaluation of Ambient Water Quality Criteria* (WERF 2007). The drinking water guidelines were not explicitly considered when deriving the Water Quality Guidelines; however, given that the ODWSs and CDWQGs are generally higher than the aquatic guidelines, evaluating the predicted water quality versus a set of criteria based only aquatic guidelines is conservative for the purposes of the water quality effects predictions.

4.2 Construction Phase

During the construction phase, the Project activities will consist of the development of site infrastructure and associated facilities prior to initiation of open pit mining. Project components, such as the MRA or TMF, are therefore not expected to be developed sufficiently to influence site water quality. However, a key water quality consideration related to construction is erosion and transport of suspended solids into the adjacent surface water features due to earthwork and other activities that will disturb soil. The implementation of BMPs for control of



erosion and sediment transport during construction will consist of contingency planning, monitoring, erosion control measures, runoff management, sediment control measures, and maintenance. The BMPs for erosion and sediment control are therefore expected to mitigate releases of suspended solids to the adjacent surface water bodies and to limit potential changes to total suspended solids concentrations. Examples of BMPs for erosion and sediment control are listed in Section 5.1.

The BMPs for sediment control will continue to be used during the operations, closure and post-closure phases, as required. Overall, the water quality of the surface water receivers is expected to remain within the range of concentrations observed under existing conditions.

4.3 Operations Phase

4.3.1 Conceptual Model

The water quality model concept for the operations phase is based on the Project configuration at the end of mine life. The operations model therefore predicts water quality of the Project components using the ultimate extents of the open pit, MRA, low-grade stockpile and TMF; this is considered to be a conservative approach as the loading rates that are used to predict contact water quality are calculated using the greatest tonnages of rock in the MRA and low-grade stockpile, and largest surface areas exposed during the life of mine in the open pit and TMF. Furthermore, it is assumed that the MRA and low-grade stockpile will not be progressively rehabilitated and direct precipitation will be allowed to infiltrate and interact with the full extent of mine rock, low-grade ore and tailings. As such, the operations phase water quality model is conservative with respect to the early years of operations, as the predicted effects associated with the ultimate extents will not likely be realized until near the end of the operations phase.

The water quality predictions are strongly influenced by the water management concept for the Project during operations. A water management strategy has been designed to maintain a closed-loop between the processing plant and the reclaim pond; that is, the water from the reclaim pond does not report to the polishing pond, but rather is recycled back to the processing plant to reduce the requirements for freshwater make-up. As such, the water quality model assumes that the effluent discharge from the site does not contain cyanide from the processing plant, nor any constituents generated by the cyanide leaching or destruction process.

The operations model assumes that the MRSPs and associated drainage capture systems will collect runoff and seepage from the MRA and low-grade stockpile, respectively, which will then be pumped to the mine water pond for temporary storage. Open pit wall runoff due to groundwater inflow, direct precipitation and pit catchment inputs are assumed to report to a pit sump and then pumped to the mine water pond. Water temporarily stored in the mine water pond will be used to meet process plant demands, with the excess water being routed to the polishing pond. Excess water in the polishing pond is assumed to be pumped to the reclaim pond, if storage in the TMF is available; otherwise, it is assumed that the excess water is discharged to the environment, as per federal and provincial metal mining effluent discharge requirements. The TDSPs and associated drainage capture systems are designed to collect seepage from the TMF and polishing pond dams, which will be pumped into the reclaim pond and polishing pond, respectively.



4.3.2 Project Site Components

Water quality predictions were completed for the following six Project site components that have the potential to affect the overall Project site water quality: open pit sump, MRA runoff and seepage, low-grade stockpile runoff and seepage, mine water pond, reclaim pond, and polishing pond. The minimum and maximum monthly average concentrations taken from the results of average, 1:25-year dry and 1:25-year wet conditions for these six Project site components are compared to federal and provincial metal mining sector effluent limits in Table 4-1.

Weathering of the exposed open pit walls, mine rock and low-grade ore is predicted to generate drainage that contains major ions (e.g., calcium, magnesium, potassium, sodium, sulphate and chloride) and metals (e.g., aluminum, arsenic, barium, cobalt, copper, phosphorous, molybdenum, nickel, strontium, uranium, vanadium and zinc). Concentrations of metals are predicted to be lower than the federal and provincial effluent discharge limits in the modelled Project site components.

Cyanide species are expected to be present in the process water and therefore the reclaim pond. Monthly average concentrations of total cyanide in the reclaim pond are predicted to be intermittently greater than the federal and provincial effluent discharge limits. The water from the reclaim pond will be recycled back to the process plant, and water from the reclaim pond is not expected to report to the polishing pond; as such, cyanide-bearing water from the process plant is not expected to be discharged to the environment through the final treated effluent discharge point.

Ammonia and nitrate are expected to be present in the open pit sump and in the drainage from the MRA and low-grade stockpile due to the use of explosives during mining of the open pit. Ammonia, and to a lesser extent nitrate, are also expected to be present in the process water, and therefore the reclaim pond, as by-products of the cyanide destruction. There are no federal and provincial effluent discharge limits for ammonia and nitrate.

The presence of the major ions, metals and nitrogen species (presented in Table 4-1) in water/drainage associated with the Project site components necessitates the need to evaluate these parameters further as part of the effects predictions of the receiving surface water environment. Predicted concentrations of these parameters in the receiving surface water environment are compared to the 95th percentile baseline concentrations and the Water Quality Guidelines in Section 4.1.4.



Table 4-1: Monthly Average Concentrations for Project Site Components, Operations Phase

Parameter	Federal and Provincial Metal Mining Effluent Limits ⁽¹⁾	Project Site Components											
		Mine Rock Area Drainage		Low-grade Stockpile Drainage		Open Pit Sump		Mine Water Pond		Reclaim Pond		Polishing Pond	
		Min	Max	Min	Max	Min	Max	Min	Max	Min	Max	Min	Max
Aluminum	-	0.0010	0.38	0.0028	0.51	0.040	0.17	0.050	0.28	0.047	0.077	0.064	0.21
Ammonia (Total)	-	0.011	2.2	0.033	2.7	5.9	30	1.6	10	12	20	1.8	5.1
Ammonia (Un-ionized)	-	0.000011	0.0089	0.000032	0.012	0.015	0.12	0.0032	0.036	0.012	0.12	0.0016	0.023
Antimony	-	0.0001	0.033	0.0002	0.04	0.004	0.018	0.0042	0.024	0.001	0.002	0.0053	0.018
Arsenic	0.5	0.00025	0.097	0.00073	0.13	0.010	0.046	0.012	0.071	0.0010	0.0050	0.013	0.051
Barium	-	0.0003	0.12	0.0009	0.16	0.021	0.085	0.018	0.089	0.031	0.049	0.024	0.067
Boron	-	0.0002	0.077	0.0006	0.10	0.013	0.046	0.011	0.058	0.000018	0.0041	0.014	0.043
Cadmium	-	0.00000053	0.00020	0.0000015	0.00027	0.000043	0.00014	0.000033	0.00015	0.0000010	0.000012	0.000046	0.00012
Calcium	-	1.6	627	4.7	843	70	327	79	457	38	64	93	332
Chloride	-	0.069	27	0.20	36	3.3	14	3.5	19	15	25	4.1	14
Cobalt	-	0.000012	0.0045	0.000034	0.0060	0.00066	0.0023	0.00062	0.0033	0.00065	0.0010	0.00074	0.0024
Copper	0.3	0.00012	0.046	0.0035	0.060	0.0060	0.024	0.0060	0.034	0.060	0.098	0.0071	0.025
Cyanide (Total) ⁽²⁾	1	-	-	-	-	-	-	-	-	0.55	1.3	-	-
Cyanide (Free) ⁽²⁾	-	-	-	-	-	-	-	-	-	0.28	0.49	-	-
Iron	-	0.00052	0.20	0.0015	0.27	0.15	0.17	0.07	0.19	0.30	0.49	0.10	0.18
Lead	0.2	0.0000040	0.0015	0.000012	0.0021	0.00026	0.0011	0.00023	0.0012	0.000078	0.00015	0.00034	0.00090
Magnesium	-	0.034	13	0.098	17	3.3	11	2.4	10	15	25	3.0	7.9
Manganese	-	0.0021	0.81	0.0061	1.1	0.14	0.48	0.12	0.61	0.039	0.076	0.15	0.46
Molybdenum	-	0.00030	0.054	0.015	0.071	0.010	0.043	0.030	0.049	0.011	0.028	0.00030	0.054
Nickel	0.5	0.000067	0.012	0.0024	0.0062	0.0016	0.0070	0.0061	0.010	0.0022	0.0055	0.000067	0.012
Nitrate	-	0.039	7.6	0.11	9.4	20	103	5.6	33	0.000093	1.1	6.0	17
Phosphorus (Total)	-	0.0036	1.4	0.010	1.9	0.13	0.63	0.17	1.0	0.0094	0.073	0.19	0.72
Potassium	-	0.12	41	0.31	55	4.2	20	5.0	29	15	25	5.7	21
Sodium	-	0.029	11	0.083	15	2.8	10	2.0	8.8	59	98	2.6	6.9
Strontium	-	0.0027	1.0	0.0076	1.4	0.11	0.52	0.13	0.74	0.073	0.12	0.15	0.54
Sulphate	-	0.13	48	0.36	65	10	41	8.1	37	148	246	11	29
Uranium	-	0.0020	0.078	0.00058	0.10	0.0090	0.042	0.010	0.057	0.0039	0.0071	0.012	0.041
Vanadium	-	0.00009	0.035	0.00026	0.047	0.0041	0.017	0.0045	0.026	0.00010	0.0018	0.0052	0.019
Zinc	0.5	0.00035	0.13	0.0010	0.18	0.025	0.090	0.021	0.10	0.0018	0.0086	0.027	0.076

Notes:

Minimum (Min) and maximum (Max) monthly average concentrations are in mg/L.

(1) Federal Metal Mining Effluent Regulation (MMER) limits (as per Schedule 4 of the MMER under the Fisheries Act; Government of Canada 2013) and provincial metal mining sector effluent limits (as per Schedule 1 of Ontario Regulation 560/94 under the Environmental Protection Act). Monthly average concentrations greater than the federal and provincial metal mining effluent limits are denoted in bold font.

(2) Total and free cyanide are predicted for the reclaim pond only, as other Project site components are not expected to contain cyanide species.



4.3.3 Treated Effluent Discharge Alternatives Analysis

An alternatives analysis was completed to evaluate two options for discharge of treated effluent; these two options are shown on Figure 2-5. The first option is the discharge of treated effluent into the downstream end of Bagsverd Creek, thereby using the lower basin of Neville Lake as a mixing zone. For this option, the outflow of Neville Lake marks the end of the mixing zone. The second option considered is the discharge of treated effluent directly into the upper/middle basin of Mesomikenda Lake, thereby using the upper/middle basin as a mixing zone. For this option, the outflow of the upper/middle basin into the upper basin of Mesomikenda Lake marks the end of the mixing zone.

The minimum and maximum monthly average concentrations taken from the results of average, 1:25-year dry and 1:25-year wet conditions for the Neville Lake (lower basin) and Mesomikenda Lake (upper/middle basin) mixing zones are shown in Table 4-2. The predicted concentrations assume “fully mixed” conditions, and therefore apply as predictions of the concentrations at the outflow of the mixing zones.

Table 4-2: Monthly Average Concentrations for Receiver Options of Treated Effluent, Operations Phase

Parameter	95 th Percentile Baseline Concentration	Water Quality Guidelines	Neville Lake (Lower, Mixing Zone)		Mesomikenda Lake (Upper/Middle, Mixing Zone)	
			Min	Max	Min	Max
Aluminum	0.12	0.075	0.047	0.054	0.047	0.063
Ammonia (Total)	0.21	6.9	0.057	0.35	0.13	0.49
Ammonia (Un-ionized)	0.00049	0.019	0.000041	0.0018	0.00015	0.0024
Antimony	0.006	0.02	0.00025	0.0012	0.00062	0.0020
Arsenic	0.003	0.005	0.0015	0.0040	0.0025	0.0063
Barium	0.007	1.0	0.0059	0.0091	0.0069	0.012
Boron	0.01	1.5	0.0051	0.0070	0.0056	0.0090
Cadmium	0.00005	0.000058	0.000020	0.000026	0.000021	0.000031
Calcium	10	-	7.4	24	14	39
Chloride	1.2	120	0.73	1.4	0.97	2.1
Cobalt	0.00025	0.0025	0.00027	0.00038	0.00030	0.00049
Copper	0.001	0.005	0.0011	0.0023	0.0015	0.0034
Iron	0.37	0.3	0.17	0.19	0.16	0.19
Lead	0.0005	0.003	0.000052	0.00010	0.000069	0.00014
Magnesium	2.0	-	1.4	1.7	1.4	2.1
Manganese	0.088	0.7	0.059	0.079	0.064	0.10
Molybdenum	0.002	0.073	0.0010	0.0028	0.0016	0.0040
Nickel	0.0015	0.025	0.0015	0.0018	0.0015	0.0020
Nitrate	0.13	13	0.062	1.1	0.35	1.6
Phosphorus (Total)	0.035	0.02	0.014	0.045	0.018	0.041
Potassium	0.49	373	0.36	1.4	0.78	2.4
Sodium	1.3	-	1.0	1.4	1.1	1.7



TECHNICAL SUPPORT DOCUMENT: WATER QUALITY

Parameter	95 th Percentile Baseline Concentration	Water Quality Guidelines	Neville Lake (Lower, Mixing Zone)		Mesomikenda Lake (Upper/Middle, Mixing Zone)	
			Min	Max	Min	Max
Strontium	0.026	-	0.017	0.044	0.028	0.068
Sulphate	4.1	218	3.1	4.6	3.5	5.8
Uranium	0.002	0.015	0.0010	0.0031	0.0018	0.0049
Vanadium	0.002	0.006	0.0010	0.0019	0.0013	0.0028
Zinc	0.032	0.02	0.0089	0.012	0.0098	0.016

Notes:

Minimum (Min) and maximum (Max) monthly average concentrations are in mg/L.

Monthly average concentrations greater than the 95th percentile baseline concentrations are denoted in bold, and monthly average concentrations greater than the 95th percentile baseline concentration and Water Quality Guidelines are denoted in bold and italics.

The water quality model predictions suggest that discharge of treated effluent into Neville Lake (lower) may result in the increase in cobalt and copper concentrations that are continuously greater than the 95th percentile baseline concentrations, and an increase in ammonia, arsenic, barium, calcium, chloride, molybdenum, nickel, nitrate, potassium, sodium, strontium, sulphate, and uranium that are intermittently greater than the 95th percentile baseline concentrations. For the Mesomikenda Lake (upper/middle) treated effluent discharge option, the water quality model predictions suggest that there may be increases in calcium, cobalt, copper, nitrate, potassium and strontium concentrations that are continuously greater than the 95th percentile baseline concentrations, and increases in ammonia, arsenic, barium, chloride, magnesium, manganese, molybdenum, nickel, sodium, sulphate, uranium and vanadium concentrations that are intermittently greater than the 95th percentile baseline concentrations. In addition, the monthly average concentrations of phosphorous are predicted to be intermittently above the 95th percentile baseline concentration and the Water Quality Guideline (aesthetic aquatic value) at the end of both the Neville Lake and Mesomikenda Lake mixing zone options. The maximum monthly concentration of arsenic is expected to be slightly greater than the Water Quality Guideline at the end of the mixing zone for the Mesomikenda Lake option only, but is expected to occur at these maximum concentrations infrequently.

Overall, a comparison of the minimum and maximum monthly average concentrations, which are taken from the results of the three climate conditions modelled, indicates that the concentrations of major ions, metals and nutrients will increase to a lesser extent in the Neville Lake (lower basin) mixing zone, as compared to the Mesomikenda Lake (upper/middle basin) mixing zone. Furthermore, phosphorous is expected to be intermittently greater than the Water Quality Guideline at the end of the Neville Lake mixing zone, whereas arsenic and phosphorous are expected to be intermittently greater than Water Quality Guideline at the end of the Mesomikenda Lake mixing zone. For these reasons, the Bagsverd Creek treated effluent discharge option is considered to have lesser effects on water quality, and is therefore the preferred option. Because discharging treated effluent to Mesomikenda Lake is not the preferred option, water quality effects are not expected in the upper/middle basin of Mesomikenda Lake, and therefore the upper/middle basin of Mesomikenda Lake is not discussed further in this report.



4.3.4 Surface Water Receivers

Predicted effects on receiving environment surface water quality were simulated by the operations phase model at 14 locations for the Bagsverd Creek treated effluent discharge option. A summary of these results are discussed by watershed below.

Mollie River Watershed

The minimum and maximum monthly average concentrations taken from the results of average, 1:25-year dry and 1:25-year wet conditions for the locations in the Mollie River Watershed are compared to the 95th percentile baseline concentrations and Water Quality Guidelines in Table 4-3.

Based on the predicted monthly average concentrations in the Mollie River Watershed during the operations phase, the key results by location are as follows:

- Chester Lake – Copper is predicted to be continuously greater than the 95th percentile baseline concentrations, and barium, calcium, cobalt, nickel, nitrate and potassium are predicted to be intermittently greater than the 95th percentile baseline concentrations.
- Clam Lake – Copper and cobalt are predicted to be continuously greater than the 95th percentile baseline concentrations, and calcium, nickel, and potassium are predicted to be intermittently greater than the 95th percentile baseline concentrations.
- Little Clam Lake - Copper and cobalt are predicted to be continuously greater than the 95th percentile baseline concentrations, and barium, calcium, nickel, and potassium are predicted to be intermittently greater than the 95th percentile baseline concentrations.
- Bagsverd Lake (south) – Copper, cobalt and nickel are predicted to be continuously greater than the 95th percentile baseline concentrations, and barium, calcium, and potassium are predicted to be intermittently greater than the 95th percentile baseline concentrations.
- Weeduck Lake – Copper, cobalt and nickel are predicted to be continuously greater than the 95th percentile baseline concentrations, and barium, calcium, and potassium are predicted to be intermittently greater than the 95th percentile baseline concentrations.
- Three Duck Lakes (upper/middle) – Ammonia (un-ionized), arsenic, barium, calcium, chloride, cobalt, copper, manganese, nickel, nitrate, sodium, strontium, sulphate and uranium are predicted to be intermittently greater than the 95th percentile baseline concentrations. Phosphorous (total) concentrations are predicted to be intermittently greater than both the 95th percentile baseline concentration and the Water Quality Guideline.
- Three Duck Lakes (lower) – Cobalt, copper, nickel and potassium are predicted to be continuously greater than the 95th percentile baseline concentrations, and barium, calcium, and nitrate are predicted to be intermittently greater than the 95th percentile baseline concentrations.
- Delaney Lake - Cobalt, copper, nickel and potassium are predicted to be continuously greater than the 95th percentile baseline concentrations, and ammonia (un-ionized), arsenic, barium, boron, calcium, chloride, magnesium, manganese, molybdenum, nitrate, phosphorous (total), sodium, strontium, sulphate and



uranium are predicted to be intermittently greater than the 95th percentile baseline concentrations. Phosphorous concentrations are predicted to be intermittently greater than both the 95th percentile baseline concentration and the Water Quality Guidelines.

- Dividing Lake – Cobalt, copper, nickel and potassium are predicted to be continuously greater than the 95th percentile baseline concentrations, and calcium is predicted to be intermittently greater than the 95th percentile baseline concentrations.

Overall, some metals (cobalt, copper and nickel) are predicted to continuously occur in the Mollie River Watershed at concentrations that are above the upper limit of baseline concentrations throughout the operations phase. To a lesser extent, other parameters, such as ammonia (un-ionized), arsenic, barium, boron, calcium, chloride, magnesium, manganese, molybdenum, nitrate, sodium, strontium, sulphate and uranium intermittently occur greater than the upper limit of baseline conditions throughout the operations phase, in particular in Three Duck Lakes (upper/middle) and Delaney Lake. However, the model predictions suggest that only phosphorous in Three Duck Lakes (upper/middle) and Delaney Lake will occur at concentrations that are intermittently greater than the 95th percentile baseline concentrations and the Water Quality Guidelines, and no other parameters are predicted to occur at concentrations greater than both the 95th percentile baseline concentrations and the Water Quality Guidelines at any locations in the Mollie River Watershed.

At the end of the Mollie River Watershed (i.e., at the outflow of Dividing Lake), the concentrations of cobalt, copper, nickel and potassium are predicted to be greater than the 95th percentile baseline concentrations, albeit only slightly; as such, concentrations that are greater than the 95th percentile baseline concentrations may extend beyond the LSA. However, if concentrations that are marginally greater than the 95th percentile baseline concentrations extend outside of the LSA, these concentrations would be expected to be localized near the downstream end of the Mollie River Watershed, as the concentrations of cobalt, copper, nickel and potassium in Dividing Lake are very near the upper range of baseline concentrations.

Mesomikenda Lake Watershed

The minimum and maximum monthly average concentrations taken from the results of average, 1:25-year dry and 1:25-year wet conditions for the locations in the Mesomikenda Lake Watershed are compared to the 95th percentile baseline concentrations and Water Quality Guidelines in Table 4-4.

Based on the predicted monthly average concentrations in the Mesomikenda Lake Watershed during the operations phase, the key results by location are as follows:

- Bagsverd Lake - Cobalt, copper, cyanide (total), and nickel, are predicted to be continuously greater than the 95th percentile baseline concentrations, and ammonia (un-ionized), barium, potassium, sodium and sulphate concentrations are predicted to be intermittently greater than the 95th percentile baseline concentrations.
- Un-named Lake #1 – Cobalt, copper, cyanide (total), and nickel, are predicted to be continuously greater than the 95th percentile baseline concentrations, and ammonia (total), ammonia (un-ionized), arsenic, barium, boron, calcium, chloride, magnesium, manganese, molybdenum, potassium, sodium, strontium, sulphate, uranium and vanadium are predicted to be intermittently greater than the 95th percentile baseline concentrations.



- Bagsverd Creek – Cyanide (total) is predicted to be continuously greater than the 95th percentile baseline concentrations, and ammonia (total), ammonia (un-ionized), barium, calcium, chloride, cobalt, copper, magnesium, manganese, molybdenum, nickel, potassium, sodium, and sulphate are predicted to be intermittently greater than the 95th percentile baseline concentrations.
- Neville Lake – Cobalt, copper, and cyanide (total) are predicted to be greater than the 95th percentile baseline concentrations, and ammonia (total), ammonia (un-ionized), arsenic, barium, calcium, chloride, molybdenum, nickel, nitrate, potassium, phosphorous (total), sodium, strontium, and sulphate are predicted to be intermittently greater than the 95th percentile baseline concentrations. Phosphorous concentrations are predicted to be intermittently greater than both the 95th percentile baseline concentrations and the Water Quality Guideline.
- Mesomikenda Lake (upper) – Cobalt, copper, and cyanide (total) are predicted to be greater than the 95th percentile baseline concentrations, and calcium and nitrate are predicted to be intermittently greater than the 95th percentile baseline concentrations.

Overall, some metals (cobalt and copper) and cyanide (total) are predicted to continuously occur in the Mesomikenda Lake Watershed at concentrations that are above the upper limit of baseline concentrations throughout the operations phase. The model predictions suggest that phosphorous in Neville Lake will occur at concentrations that are intermittently greater than the 95th percentile baseline concentrations and the Water Quality Guidelines (aesthetic aquatic guideline), but no other parameters are expected to be greater than both the 95th percentile baseline concentrations and the Water Quality Guidelines at all locations in the Mesomikenda Lake Watershed.

At the end of the Mesomikenda Lake Watershed (i.e., at the outflow of the upper basin of Mesomikenda Lake), the concentrations of cobalt, copper, and cyanide (total) are predicted to be greater than the 95th percentile baseline concentrations; as such, concentrations that are greater than the 95th percentile baseline concentrations may extend beyond the LSA. However, as with the Mollie River Watershed, if concentrations that are marginally greater than the 95th percentile baseline concentrations extend outside of the LSA, these concentrations would be expected to be localized near the downstream end of the Mesomikenda Lake Watershed because the concentrations of cobalt, copper, and cyanide (total) in Mesomikenda Lake (upper) are very near the upper range of baseline concentrations.



TECHNICAL SUPPORT DOCUMENT: WATER QUALITY

Table 4-3: Monthly Average Concentrations for Locations in Mollie River Watershed, Operations Phase

Parameter	95 th Percentile Baseline Conc.	Water Quality Guidelines	Mollie River Watershed																	
			Chester Lake		Clam Lake		Little Clam Lake		Bagsverd Lake (South)		Weeduck Lake		Three Duck Lakes (Upper/Middle)		Three Duck Lakes (Lower)		Delaney Lake		Dividing Lake	
			Min	Max	Min	Max	Min	Max	Min	Max	Min	Max	Min	Max	Min	Max	Min	Max	Min	Max
Aluminum	0.12	0.075	0.040	0.055	0.047	0.053	0.047	0.058	0.048	0.060	0.048	0.055	0.037	0.067	0.049	0.053	0.048	0.10	0.051	0.053
Ammonia (Total)	0.21	6.9	0.055	0.078	0.056	0.073	0.058	0.074	0.060	0.077	0.060	0.070	0.051	0.11	0.064	0.078	0.053	0.14	0.065	0.074
Ammonia (Un-ion.)	0.00049	0.019	0.000041	0.00047	0.000038	0.00043	0.000038	0.00049	0.000037	0.00047	0.000038	0.00044	0.000035	0.00066	0.000045	0.00047	0.000054	0.00073	0.000040	0.00047
Antimony	0.006	0.02	0.00031	0.00053	0.00032	0.00045	0.00032	0.00046	0.00034	0.00044	0.00034	0.00040	0.00029	0.00076	0.00039	0.00050	0.00028	0.00093	0.00038	0.00045
Arsenic	0.003	0.005	0.0017	0.0023	0.0017	0.0022	0.0018	0.0022	0.0018	0.0023	0.0018	0.0021	0.0015	0.0033	0.0019	0.0023	0.0016	0.0044	0.0020	0.0022
Barium	0.007	1.0	0.0054	0.0073	0.0061	0.0070	0.0061	0.0075	0.0062	0.0078	0.0062	0.0072	0.0049	0.0092	0.0064	0.0071	0.0060	0.014	0.0066	0.0069
Boron	0.01	1.5	0.0046	0.0062	0.0052	0.0060	0.0052	0.0064	0.0054	0.0067	0.0054	0.0061	0.0042	0.0077	0.0055	0.0060	0.0052	0.012	0.0056	0.0059
Cadmium	0.00005	0.000058	0.000018	0.000024	0.000020	0.000023	0.000020	0.000025	0.000021	0.000026	0.000021	0.000024	0.000016	0.000029	0.000022	0.000023	0.000021	0.000045	0.000022	0.000023
Calcium	10	-	8.5	13	8.6	11	8.9	11	9.2	12	9.2	11	7.6	18	10	12	8.0	23	10	11
Chloride	1.2	120	0.74	0.97	0.78	0.93	0.80	0.98	0.80	1.00	0.80	0.92	0.64	1.30	0.84	0.95	0.75	1.83	0.86	0.92
Cobalt	0.00025	0.0025	0.00024	0.00033	0.00028	0.00032	0.00028	0.00034	0.00029	0.00036	0.00029	0.00033	0.00022	0.00042	0.00029	0.00032	0.00028	0.00062	0.00030	0.00032
Copper	0.001	0.005	0.0011	0.0015	0.0011	0.0014	0.0012	0.0015	0.0012	0.0015	0.0012	0.0014	0.0010	0.0020	0.0013	0.0014	0.0011	0.0028	0.0013	0.0014
Cyanide (Total) ⁽¹⁾	0.001	-	-	-	-	-	-	-	-	-	-	-	-	-	-	-	-	-	-	-
Cyanide (Free) ⁽¹⁾	-	0.0098	-	-	-	-	-	-	-	-	-	-	-	-	-	-	-	-	-	-
Iron	0.37	0.3	0.14	0.20	0.17	0.19	0.17	0.21	0.18	0.22	0.18	0.20	0.13	0.23	0.18	0.19	0.18	0.37	0.18	0.19
Lead	0.0005	0.003	0.000051	0.000068	0.000055	0.000065	0.000056	0.000069	0.000057	0.000071	0.000057	0.000065	0.000045	0.000089	0.000059	0.000066	0.000054	0.00013	0.000060	0.000064
Magnesium	2.0	-	1.2	1.6	1.4	1.6	1.4	1.7	1.4	1.8	1.4	1.6	1.1	2.0	1.4	1.5	1.4	3.0	1.5	1.5
Manganese	0.088	0.7	0.052	0.071	0.060	0.069	0.060	0.074	0.062	0.077	0.062	0.071	0.048	0.088	0.063	0.069	0.060	0.133	0.065	0.068
Molybdenum	0.002	0.073	0.0011	0.0014	0.0011	0.0013	0.0011	0.0014	0.0011	0.0014	0.0011	0.0013	0.00092	0.0019	0.0012	0.0014	0.0011	0.0026	0.0012	0.0013
Nickel	0.0015	0.025	0.0013	0.0018	0.0015	0.0017	0.0015	0.0019	0.0016	0.0020	0.0016	0.0018	0.0012	0.0021	0.0016	0.0017	0.0016	0.0033	0.0017	0.0017
Nitrate	0.13	13	0.080	0.16	0.081	0.13	0.083	0.13	0.093	0.12	0.093	0.11	0.082	0.23	0.11	0.15	0.07	0.25	0.11	0.13
Phosphorus (Total)	0.035	0.02	0.016	0.025	0.016	0.022	0.017	0.022	0.017	0.022	0.017	0.020	0.015	0.036	0.019	0.024	0.015	0.045	0.019	0.022
Potassium	0.49	373	0.42	0.68	0.43	0.60	0.44	0.60	0.46	0.59	0.46	0.54	0.39	0.99	0.52	0.65	0.39	1.2	0.51	0.59
Sodium	1.3	-	0.88	1.2	1.0	1.2	1.0	1.3	1.1	1.3	1.1	1.2	0.81	1.5	1.1	1.2	1.0	2.3	1.1	1.2
Strontium	0.026	-	0.019	0.026	0.019	0.024	0.020	0.025	0.020	0.025	0.020	0.023	0.017	0.036	0.022	0.025	0.018	0.048	0.022	0.024
Sulphate	4.1	218	2.8	3.8	3.1	3.6	3.1	3.9	3.2	4.0	3.2	3.7	2.5	4.7	3.3	3.6	3.2	7.0	3.4	3.6
Uranium	0.002	0.015	0.0012	0.0017	0.0012	0.0015	0.0012	0.0015	0.0012	0.0016	0.0012	0.0014	0.0010	0.0023	0.0013	0.0016	0.0011	0.0031	0.0013	0.0015
Vanadium	0.002	0.006	0.0010	0.0014	0.0011	0.0013	0.0011	0.0014	0.0011	0.0014	0.0011	0.0013	0.00090	0.0018	0.0012	0.0013	0.0011	0.0026	0.0012	0.0013
Zinc	0.032	0.02	0.0079	0.011	0.0091	0.010	0.0091	0.011	0.0093	0.012	0.0093	0.0093	0.0073	0.013	0.0096	0.010	0.0091	0.020	0.0098	0.010

Notes:
 Minimum (Min) and maximum (Max) monthly average concentrations are in mg/L.
 Monthly average concentrations greater than the 95th percentile baseline concentrations are denoted in bold, and monthly average concentrations greater than the 95th percentile baseline concentration and Water Quality Guidelines are denoted in bold and italics.
 (1) Total and free cyanide are not predicted for Mollie River Watershed locations, as there is assumed not to be a source of cyanide to this watershed.



TECHNICAL SUPPORT DOCUMENT: WATER QUALITY

Table 4-4: Monthly Average Concentrations for Locations in Mesomikenda Lake Watershed, Operations Phase

Parameter	95 th Percentile Baseline Conc.	Water Quality Guidelines	MESOMIKENDA LAKE WATERSHED									
			Bagsverd Lake		Un-named Lake #1		Bagsverd Creek		Neville Lake (Lower, Mixing Zone)		Mesomikenda Lake (Upper)	
			Min	Max	Min	Max	Min	Max	Min	Max	Min	Max
Aluminum	0.12	0.075	0.049	0.059	0.049	0.096	0.022	0.071	0.047	0.054	0.045	0.047
Ammonia (Total)	0.21	6.9	0.077	0.13	0.082	0.37	0.075	0.23	0.057	0.35	0.060	0.076
Ammonia (Un-ion.)	0.00049	0.019	0.0001	0.0007	0.0001	0.0022	0.0001	0.0012	0.000041	0.0018	0.000042	0.0004
Antimony	0.006	0.02	0.00027	0.00033	0.00027	0.00053	0.00012	0.00039	0.00025	0.0012	0.00028	0.00035
Arsenic	0.003	0.005	0.0016	0.0019	0.0016	0.0031	0.0007	0.0023	0.0015	0.0040	0.0016	0.0018
Barium	0.007	1.0	0.0062	0.0076	0.0062	0.0125	0.0029	0.0092	0.0059	0.0091	0.0058	0.0061
Boron	0.01	1.5	0.0054	0.0065	0.0053	0.0103	0.0024	0.0077	0.0051	0.0070	0.0050	0.0052
Cadmium	0.00005	0.000058	0.000022	0.000026	0.000021	0.000041	0.000010	0.000031	0.000020	0.000026	0.000020	0.000021
Calcium	10	-	7.9	9.6	7.9	16	3.7	12	7.4	24	7.7	9.1
Chloride	1.2	120	0.79	0.99	0.79	1.80	0.42	1.3	0.73	1.4	0.72	0.79
Cobalt	0.00025	0.0025	0.00029	0.00035	0.00029	0.00056	0.00013	0.00042	0.00027	0.00038	0.00026	0.00028
Copper	0.001	0.005	0.0012	0.0016	0.0012	0.0031	0.0007	0.0022	0.0011	0.0023	0.0011	0.0012
Cyanide (Total)	0.001	-	0.0039	0.0083	0.0045	0.029	0.0039	0.018	0.0015	0.0035	0.0016	0.0017
Cyanide (Free)	-	0.0098	0.0010	0.0021	0.0011	0.0073	0.0010	0.0044	0.00045	0.00092	0.00043	0.00045
Iron	0.37	0.3	0.18	0.22	0.18	0.36	0.084	0.26	0.17	0.19	0.16	0.17
Magnesium	2.0	-	1.5	1.8	1.5	3.1	0.72	2.2	1.4	1.7	1.3	1.4
Manganese	0.088	0.7	0.062	0.075	0.062	0.12	0.028	0.089	0.059	0.079	0.057	0.060
Molybdenum	0.002	0.073	0.0011	0.0014	0.0011	0.0027	0.00064	0.0019	0.0010	0.0028	0.0010	0.0012
Lead	0.0005	0.003	0.000055	0.000067	0.000055	0.000107	0.000025	0.000079	0.000052	0.00010	0.000052	0.000056
Nickel	0.0015	0.025	0.0016	0.0020	0.0016	0.0032	0.0008	0.0024	0.0015	0.0018	0.0015	0.0015
Nitrate	0.13	13	0.066	0.079	0.066	0.13	0.030	0.094	0.062	1.1	0.090	0.14
Phosphorus (Total)	0.035	0.02	0.014	0.017	0.014	0.028	0.007	0.021	0.014	0.045	0.014	0.015
Potassium	0.49	373	0.40	0.52	0.40	1.0	0.24	0.72	0.36	1.4	0.38	0.47
Sodium	1.3	-	1.2	1.6	1.2	3.4	0.79	2.3	1.0	1.4	1.0	1.0
Strontium	0.026	-	0.018	0.022	0.018	0.036	0.0085	0.027	0.017	0.044	0.018	0.020
Sulphate	4.1	218	3.5	4.7	3.6	9.5	2.2	6.5	3.1	4.6	3.0	3.2
Uranium	0.002	0.015	0.0011	0.0013	0.0011	0.0021	0.00050	0.0016	0.0010	0.0031	0.0011	0.0012
Vanadium	0.002	0.006	0.0011	0.0013	0.0011	0.0021	0.00049	0.0015	0.0010	0.0019	0.0010	0.0011
Zinc	0.032	0.02	0.0094	0.011	0.0093	0.018	0.0042	0.013	0.0089	0.012	0.0086	0.0091

Notes:

Minimum (Min) and maximum (Max) monthly average concentrations are in mg/L.

Monthly average concentrations greater than the 95th percentile baseline concentrations are denoted in bold, and monthly average concentrations greater than the 95th percentile baseline concentration and Water Quality Guidelines are denoted in bold and italics.



4.4 Closure Phase

The closure phase will consist of decommissioning and rehabilitation works in accordance with the closure concept presented in the Conceptual Closure Plan (see EIS report). Similar to the construction phase, a key water quality consideration related to closure is erosion and transport of suspended solids into the adjacent surface water features due to earthworks and other activities that will disturb soil. Similar to the construction phase, BMPs for control of erosion and sediment transport will be implemented during closure. These BMPs will minimize erosion and mitigate any potential increases to total suspended solids in the surface water receivers.

For the purposes of the water quality effects predictions for the closure phase, the water quality model results for the operations phase were applied to the closure phase. For the locations in the Mollie River Watershed, applying the operations model results are reasonable, as the sources of mass load during the closure phase will not change considerably from operations. As such, the water quality at the locations in the Mollie River Watershed are expected to be similar to the predictions for the operations phase.

For the locations in the Mesomikenda Lake watershed, applying the operations phase model results for the closure phase is conservative, as the treated effluent is no longer being discharged to the environment from the polishing pond. Rather, water from the mine water pond will be pumped to the open pit. Therefore, as the predicted effects to water quality due to discharge of treated effluent dissipate, the water quality at the locations in the Mesomikenda Lake Watershed is expected to improve over time relative to the predictions for the operations phase.

4.5 Post-closure Phase Stage I

4.5.1 Conceptual Model

The water quality model for the operations phase was modified to model the post-closure phase in accordance with the closure concept presented in the Conceptual Closure Plan (see EIS report). Once mining at the Project site is complete, dewatering activities will cease and the open pit will be allowed to flood. Water input that will contribute to the pit flooding will consist of groundwater inflow and runoff from the adjacent catchment area, including runoff from the decommissioned mine water pond area, process plant area, former low-grade stockpile area, and the northern portion of the MRA. Under post-closure conditions, the open pit is estimated to return to the approximate elevation of Côté Lake after approximately 50 to 80 years following the decommissioning of the pit sump pumps (see Hydrology and Climate TSD). Given that the time for the open pit to flood to equilibrium levels is on the order of decades, the post-closure phase was divided into two stages to predict the effects to water quality during post-closure when the pit is flooding (stage I), and after the pit is completely flooded and has formed the Côté Pit Lake that then discharges into the Mollie River system (stage II).

Based on the closure concept, the water quality modelling assumes that the Project site facilities will be decommissioned and rehabilitated during the closure phase. A vegetated soil cover will be constructed over the surface of the TMF, polishing pond and approximately 25% of the MRA. The process plant and associated infrastructure will have already been decommissioned and demolished prior to post-closure, and plant and camp site areas will be revegetated. The low-grade ore stockpile will not be present on the Project site during post-closure, as it is assumed that all low-grade ore will be processed before entering the closure phase.

Drainage from the TMF will passively discharge toward the east and into a natural channel that reports to the middle basin of Mesomikenda Lake. Surplus from the polishing pond will passively discharge into Bagsverd



Creek. Runoff and seepage collected from the MRA will be pumped to the open pit during the post-closure phase stage I. Erosion and sediment transport controls will be maintained, as required, until vegetation has sufficiently been established to act as a natural mitigation measure.

4.5.2 Surface Water Receivers

Predicted effects on receiving environment surface water quality were simulated by the post-closure phase stage I model at 14 locations. A summary of these results are discussed by watershed below.

Mollie River Watershed

The minimum and maximum monthly average concentrations taken from the results of average, 1:25-year dry and 1:25-year wet conditions for the locations in the Mollie River Watershed are compared to the 95th percentile baseline concentrations and Water Quality Guidelines in Table 4-5.

Based on the predicted monthly average concentrations in the Mollie River Watershed during the post-closure phase stage I, the key results by location are as follows:

- Chester Lake – Copper is predicted to be continuously greater than the 95th percentile baseline concentrations, and barium, calcium, cobalt, nickel, and potassium are predicted to be intermittently greater than the 95th percentile baseline concentrations.
- Clam Lake – Copper and cobalt are predicted to be continuously greater than the 95th percentile baseline concentrations, and barium, calcium, nickel, and potassium are predicted to be intermittently greater than the 95th percentile baseline concentrations.
- Little Clam Lake - Copper and cobalt are predicted to be continuously greater than the 95th percentile baseline concentrations, and barium, calcium, nickel, and potassium are predicted to be intermittently greater than the 95th percentile baseline concentrations.
- Bagsverd Lake (south) – Copper, cobalt and nickel are predicted to be continuously greater than the 95th percentile baseline concentrations, and barium, calcium, and potassium are predicted to be intermittently greater than the 95th percentile baseline concentrations.
- Weeduck Lake – Copper, cobalt and nickel are predicted to be continuously greater than the 95th percentile baseline concentrations, and barium, calcium, and potassium are predicted to be intermittently greater than the 95th percentile baseline concentrations.
- Three Duck Lakes (upper/middle) – Arsenic, barium, calcium, chloride, cobalt, copper, manganese, nickel, potassium, sodium, strontium, sulphate and uranium are predicted to be intermittently greater than the 95th percentile baseline concentrations. Phosphorous (total) concentrations are predicted to be intermittently greater than both the 95th percentile baseline concentrations and the Water Quality Guideline.
- Three Duck Lakes (lower) - Cobalt, copper, nickel, and potassium are predicted to be continuously greater than the 95th percentile baseline concentrations, and barium and calcium are predicted to be intermittently greater than the 95th percentile baseline concentrations.



- Delaney Lake - Cobalt, copper, and nickel are predicted to be continuously greater than the 95th percentile baseline concentrations, and ammonia (un-ionized), arsenic, barium, boron, calcium, chloride, magnesium, manganese, molybdenum, nickel, potassium, sodium, strontium, sulphate, uranium and vanadium are predicted to be intermittently greater than the 95th percentile baseline concentrations. Phosphorous concentrations are predicted to be intermittently greater than both the 95th percentile baseline concentrations and the Water Quality Guidelines.
- Dividing Lake – Copper, cobalt, nickel, and potassium are predicted to be continuously greater than the 95th percentile baseline concentrations, and calcium is predicted to be intermittently greater than the 95th percentile baseline concentrations.

Overall, the water quality predicted throughout the post-closure phase (stage I) is similar to the water quality during the operations phase for the Mollie River Watershed. The exception is the concentrations of ammonia and nitrate that are predicted to be lower than during the post-closure phase, which is a result of the source term (explosive residuals in mine rock) that is assumed to be depleted over the course of the operations and closure phases.

As with the operations phase, some metals (cobalt, copper and nickel) during the post-closure phase (stage I) are predicted to continuously occur in the Mollie River Watershed at concentrations that are above the upper limit of baseline concentrations. To a lesser extent, other parameters, such as, arsenic, barium, boron, calcium, chloride, magnesium, manganese, molybdenum, sodium, strontium, sulphate and uranium intermittently occur greater than the upper limit of baseline conditions throughout the post-closure phase (stage I), in particular in Three Duck Lakes (upper/middle) and Delaney Lake. However, the model predictions suggest that only phosphorous in Three Duck Lakes (upper/middle) and Delaney Lake will intermittently occur at concentrations that are greater than both the 95th percentile baseline concentration and the Water Quality Guidelines. Monthly average concentrations of all other parameters are predicted to not be greater than both the 95th percentile baseline concentrations and the Water Quality Guidelines.

Similar to the operations phase, the monthly average concentrations of cobalt, copper, nickel and potassium are predicted to be greater than the 95th percentile baseline concentrations at the end of the Mollie River Watershed (i.e., at the outflow of Dividing Lake) during post-closure phase stage I. However, if these parameters occur at concentrations marginally greater than the 95th percentile baseline concentrations outside of the LSA, the extent of these concentrations is expected to be localized near the downstream end of the Mollie River Watershed, as the concentrations of cobalt, copper, nickel and potassium in Dividing Lake are very near the upper range of baseline concentrations.

Mesomikenda Lake Watershed

The minimum and maximum monthly average concentrations taken from the results of average, 1:25-year dry and 1:25-year wet conditions for the locations in the Mesomikenda Lake Watershed are compared to the 95th percentile baseline concentrations and Water Quality Guidelines in Table 4-6.

Based on the predicted monthly average concentrations in the Mesomikenda Lake Watershed during the post-closure phase stage I, the key results by location are as follows:



- Bagsverd Lake - Cobalt, copper, cyanide (total), and nickel, are predicted to be continuously greater than the 95th percentile baseline concentrations, and barium, potassium, sodium and sulphate concentrations are predicted to be intermittently greater than the 95th percentile baseline concentrations.
- Un-named Lake #1 – Cobalt, copper, cyanide (total), and nickel, are predicted to be continuously greater than the 95th percentile baseline concentrations, and ammonia (un-ionized), barium, calcium, chloride, magnesium, manganese, molybdenum, potassium, sodium, strontium, and sulphate are predicted to be intermittently greater than the 95th percentile baseline concentrations.
- Bagsverd Creek – Copper and cyanide (total) are predicted to be continuously greater than the 95th percentile baseline concentrations, and ammonia (un-ionized), barium, calcium, chloride, cobalt, magnesium, nickel, potassium, sodium, and sulphate are predicted to be intermittently greater than the 95th percentile baseline concentrations.
- Neville Lake – Cobalt, copper, cyanide (total) and nickel are predicted to be continuously greater than the 95th percentile baseline concentrations, and barium, calcium, chloride, magnesium, manganese, molybdenum, potassium, phosphorous (total), sodium, strontium, and sulphate are predicted to be intermittently greater than the 95th percentile baseline concentrations.
- Mesomikenda Lake (upper) – Cobalt, cyanide (total) and nickel are predicted to be continuously greater than the 95th percentile baseline concentrations, and barium, chloride, manganese and potassium are predicted to be intermittently greater than the 95th percentile baseline concentrations.

Similar to the operations phase, some metals (cobalt, copper and nickel) and cyanide (total) are predicted to occur in the Mesomikenda Lake Watershed at concentrations that are above the upper limit of baseline concentrations throughout the post-closure phase (stage I). However, for post-closure stage I, the model predictions suggest that no parameters are expected to be greater than both the 95th percentile baseline concentrations and the Water Quality Guidelines at all locations in the Mesomikenda Lake Watershed.

At the end of the Mesomikenda Lake Watershed (i.e., at the outflow of the upper basin of Mesomikenda Lake), the concentrations of cobalt, nickel and cyanide (total) are predicted to be greater than the 95th percentile baseline concentrations. Therefore, like the Mollie River Watershed, there is potential for concentrations that are greater than the 95th percentile baseline concentrations to extend beyond the LSA. However, given that the concentrations of cobalt, nickel and cyanide (total) in Mesomikenda Lake (upper) are very near the upper range of baseline concentrations, any concentrations marginally greater than the 95th percentile baseline concentration would be expected to be localized near the downstream end of the Mesomikenda Lake Watershed.



TECHNICAL SUPPORT DOCUMENT: WATER QUALITY

Table 4-5: Monthly Average Concentrations for Locations in Mollie River Watershed, Post-closure Phase Stage I

Parameter	95 th Percentile Baseline Conc.	Water Quality Guidelines	Mollie River Watershed																	
			Chester Lake		Clam Lake		Little Clam Lake		Bagsverd Lake (South)		Weeduck Lake		Three Duck Lakes (Upper/Middle)		Three Duck Lakes (Lower)		Delaney Lake		Dividing Lake	
			Min	Max	Min	Max	Min	Max	Min	Max	Min	Max	Min	Max	Min	Max	Min	Max	Min	Max
Aluminum	0.12	0.075	0.040	0.055	0.047	0.053	0.047	0.058	0.048	0.060	0.048	0.055	0.037	0.067	0.049	0.053	0.048	0.10	0.051	0.053
Ammonia (Total)	0.21	6.9	0.041	0.057	0.049	0.055	0.049	0.060	0.051	0.063	0.051	0.058	0.037	0.066	0.051	0.054	0.051	0.11	0.053	0.055
Ammonia (Un-ion.)	0.00049	0.019	0.000026	0.00033	0.000030	0.00035	0.000030	0.00040	0.000032	0.00039	0.000033	0.00036	0.00002	0.00041	0.00003	0.00034	0.000041	0.00056	0.000033	0.00036
Antimony	0.006	0.02	0.00031	0.00053	0.00032	0.00045	0.00032	0.00046	0.00034	0.00044	0.00034	0.00040	0.00029	0.00076	0.00039	0.00050	0.00028	0.00093	0.00038	0.00045
Arsenic	0.003	0.005	0.002	0.002	0.002	0.002	0.0018	0.0022	0.0018	0.0023	0.0018	0.0021	0.0015	0.0033	0.0019	0.0023	0.0016	0.0044	0.0020	0.0022
Barium	0.007	1.0	0.0054	0.0073	0.0061	0.0070	0.0061	0.0075	0.0062	0.0078	0.0062	0.0072	0.0049	0.0092	0.0064	0.0071	0.0060	0.0137	0.0066	0.0069
Boron	0.01	1.5	0.0046	0.0062	0.0052	0.0060	0.0052	0.0064	0.0054	0.0067	0.0054	0.0061	0.0042	0.0077	0.0055	0.0060	0.0052	0.0116	0.0056	0.0059
Cadmium	0.00005	0.000058	0.000018	0.000024	0.000020	0.000023	0.000020	0.000025	0.000021	0.000026	0.000021	0.000024	0.000016	0.000029	0.000022	0.000023	0.000021	0.000045	0.000022	0.000023
Calcium	10	-	8.5	13	8.6	11	8.9	11	9.2	12	9.2	11	7.6	18	10	12	8.0	23	10	11
Chloride	1.2	120	0.74	0.97	0.78	0.93	0.80	0.98	0.80	1.00	0.80	0.92	0.64	1.30	0.84	0.95	0.75	1.83	0.86	0.92
Cobalt	0.00025	0.0025	0.00024	0.00033	0.00028	0.00032	0.00028	0.00034	0.00029	0.00036	0.00029	0.00033	0.00022	0.00042	0.00029	0.00032	0.00028	0.00062	0.00030	0.00032
Copper	0.001	0.005	0.0011	0.0015	0.0011	0.0014	0.0012	0.0015	0.0012	0.0015	0.0012	0.0014	0.0010	0.0020	0.0013	0.0014	0.0011	0.0028	0.0013	0.0014
Cyanide (Total) ⁽¹⁾	0.001	-	-	-	-	-	-	-	-	-	-	-	-	-	-	-	-	-	-	-
Cyanide (Free) ⁽¹⁾	-	0.0098	-	-	-	-	-	-	-	-	-	-	-	-	-	-	-	-	-	-
Iron	0.37	0.3	0.14	0.20	0.17	0.19	0.17	0.21	0.17	0.22	0.18	0.20	0.13	0.23	0.18	0.19	0.18	0.37	0.18	0.19
Lead	0.0005	0.003	0.000051	0.000068	0.000055	0.000065	0.000056	0.000069	0.000057	0.000071	0.000057	0.000065	0.00022	0.00042	0.00029	0.00032	0.00028	0.00062	0.00030	0.00032
Magnesium	2.0	-	1.2	1.6	1.4	1.6	1.4	1.7	1.4	1.8	1.4	1.6	1.1	2.0	1.4	1.5	1.4	3.0	1.5	1.5
Manganese	0.088	0.7	0.052	0.071	0.060	0.069	0.060	0.074	0.062	0.077	0.062	0.071	0.048	0.088	0.063	0.069	0.060	0.13	0.065	0.068
Molybdenum	0.002	0.073	0.0011	0.0014	0.0011	0.0013	0.0011	0.0014	0.0011	0.0014	0.0011	0.0013	0.00092	0.0019	0.0012	0.0014	0.0011	0.0026	0.0012	0.0013
Nickel	0.0015	0.025	0.0013	0.0018	0.0015	0.0017	0.0015	0.0019	0.0016	0.0020	0.0016	0.0018	0.0012	0.0021	0.0016	0.0017	0.0016	0.0033	0.0017	0.0017
Nitrate	0.13	13	0.050	0.071	0.060	0.068	0.060	0.075	0.063	0.079	0.063	0.072	0.047	0.082	0.063	0.067	0.063	0.13	0.066	0.068
Phosphorus (Total)	0.035	0.02	0.016	0.025	0.016	0.022	0.017	0.022	0.017	0.022	0.017	0.020	0.015	0.036	0.019	0.024	0.015	0.05	0.019	0.022
Potassium	0.49	373	0.42	0.68	0.43	0.60	0.44	0.60	0.46	0.59	0.46	0.54	0.39	0.99	0.52	0.65	0.39	1.2	0.51	0.59
Sodium	1.3	-	0.88	1.2	1.0	1.2	1.0	1.3	1.1	1.3	1.1	1.2	0.81	1.5	1.1	1.2	1.0	2.3	1.1	1.2
Strontium	0.026	-	0.019	0.026	0.019	0.024	0.020	0.025	0.020	0.025	0.020	0.023	0.017	0.036	0.022	0.025	0.018	0.048	0.022	0.024
Sulphate	4.1	218	2.8	3.8	3.1	3.6	3.1	3.9	3.2	4.0	3.2	3.7	2.5	4.7	3.3	3.6	3.2	7.0	3.4	3.6
Uranium	0.002	0.015	0.0012	0.0017	0.0012	0.0015	0.0012	0.0015	0.0012	0.0016	0.0012	0.0014	0.0010	0.0023	0.0013	0.0016	0.0011	0.0031	0.0013	0.0015
Vanadium	0.002	0.006	0.0010	0.0014	0.0011	0.0013	0.0011	0.0014	0.0011	0.0014	0.0011	0.0013	0.00090	0.0018	0.0012	0.0013	0.0011	0.0026	0.0012	0.0013
Zinc	0.032	0.02	0.0079	0.011	0.0091	0.010	0.0091	0.0112	0.0093	0.012	0.0093	0.0093	0.0073	0.013	0.0096	0.010	0.0091	0.020	0.0098	0.010

Notes:
 Minimum (Min) and maximum (Max) monthly average concentrations are in mg/L.
 Monthly average concentrations greater than the 95th percentile baseline concentrations are denoted in bold, and monthly average concentrations greater than the 95th percentile baseline concentration and Water Quality Guidelines are denoted in bold and italics.
 (1) Total and free cyanide are not predicted for Mollie River Watershed locations, as there is assumed not to be a source of cyanide to this watershed.



TECHNICAL SUPPORT DOCUMENT: WATER QUALITY

Table 4-6: Monthly Average Concentrations for Locations in Mesomikenda Lake Watershed, Post-closure Phase Stage I

Parameter	95 th Percentile Baseline Conc.	Water Quality Guidelines	Mesomikenda Lake Watershed									
			Bagsverd Lake		Un-named Lake #1		Bagsverd Creek		Neville Lake		Mesomikenda Lake (Upper)	
			Min	Max	Min	Max	Min	Max	Min	Max	Min	Max
Aluminum	0.12	0.075	0.049	0.059	0.049	0.091	0.038	0.067	0.055	0.071	0.041	0.046
Ammonia (Total)	0.21	6.9	0.061	0.082	0.061	0.17	0.059	0.105	0.062	0.081	0.045	0.050
Ammonia (Un-ion.)	0.00049	0.019	0.000045	0.00048	0.000055	0.0010	0.000055	0.00059	0.000043	0.00049	0.000028	0.00034
Antimony	0.006	0.02	0.00027	0.00032	0.00027	0.00050	0.00021	0.00037	0.00027	0.00050	0.00030	0.00039
Arsenic	0.003	0.005	0.0016	0.0019	0.0016	0.0030	0.0012	0.0022	0.0018	0.0023	0.0013	0.0015
Barium	0.007	1.0	0.0062	0.0075	0.0062	0.0119	0.0049	0.0087	0.0062	0.0118	0.0069	0.0089
Boron	0.01	1.5	0.0054	0.0064	0.0053	0.0098	0.0041	0.0073	0.0053	0.0098	0.0060	0.0077
Cadmium	0.00005	0.000058	0.000022	0.000026	0.000021	0.000039	0.000016	0.000029	0.000021	0.000039	0.000024	0.000031
Calcium	10	-	7.9	9.5	7.8	15	6.2	11	8.7	11	6.6	7.3
Chloride	1.2	120	0.79	0.99	0.79	1.7	0.70	1.2	0.79	1.7	0.86	1.1
Cobalt	0.00025	0.0025	0.00029	0.00035	0.00028	0.00054	0.00022	0.00039	0.00029	0.00053	0.00032	0.00041
Copper	0.001	0.005	0.0012	0.0015	0.0012	0.0027	0.0011	0.0018	0.0013	0.0016	0.00094	0.0010
Cyanide (Total)	0.001	-	0.0040	0.0081	0.0044	0.0280	0.0038	0.0151	0.0023	0.0040	0.0016	0.0018
Cyanide (Free)	-	0.0098	0.00062	0.0016	0.00072	0.0063	0.00056	0.0033	0.00012	0.00051	0.000078	0.000090
Iron	0.37	0.3	0.18	0.22	0.18	0.34	0.14	0.25	0.20	0.26	0.15	0.17
Lead	0.0005	0.003	0.000055	0.000066	0.000055	0.000102	0.000042	0.000075	0.000055	0.000101	0.000061	0.000079
Magnesium	2.0	-	1.5	1.8	1.5	2.9	1.2	2.1	1.6	2.1	1.2	1.3
Manganese	0.088	0.7	0.062	0.075	0.062	0.114	0.047	0.085	0.062	0.11	0.069	0.090
Molybdenum	0.002	0.073	0.0011	0.0014	0.0011	0.0026	0.0011	0.0017	0.0011	0.0025	0.0012	0.0016
Nickel	0.0015	0.025	0.0016	0.0020	0.0016	0.0031	0.0013	0.0023	0.0016	0.0031	0.0018	0.0023
Nitrate	0.13	13	0.066	0.079	0.065	0.120	0.050	0.089	0.073	0.095	0.055	0.061
Phosphorus (Total)	0.035	0.02	0.014	0.017	0.014	0.026	0.011	0.020	0.016	0.021	0.012	0.013
Potassium	0.49	373	0.40	0.52	0.40	0.99	0.39	0.64	0.40	0.97	0.42	0.55
Sodium	1.3	-	1.2	1.6	1.2	3.2	1.2	2.0	1.2	1.6	0.91	1.0
Strontium	0.026	-	0.018	0.022	0.018	0.035	0.014	0.025	0.020	0.026	0.015	0.017
Sulphate	4.1	218	3.6	4.6	3.6	9.1	3.5	5.8	3.7	4.8	2.8	3.1
Uranium	0.002	0.015	0.0011	0.0013	0.0011	0.0020	0.00084	0.0015	0.0012	0.0016	0.00090	0.0010
Vanadium	0.002	0.006	0.0011	0.0013	0.0011	0.0020	0.00082	0.0015	0.0012	0.0015	0.00090	0.0010
Zinc	0.032	0.02	0.0094	0.011	0.0093	0.017	0.0071	0.013	0.010	0.014	0.0078	0.0088

Notes:

Minimum (Min) and maximum (Max) monthly average concentrations are in mg/L.

Monthly average concentrations greater than the 95th percentile baseline concentrations are denoted in bold, and monthly average concentrations greater than the 95th percentile baseline concentration and Water Quality Guidelines are denoted in bold and italics.



4.6 Post-closure Phase Stage II

4.6.1 Conceptual Model

The water quality model concept for the post-closure phase stage II is based on modifications to the stage I model, which account for the changes to the Project site hydrology. Once the open pit has flooded to static levels, runoff and seepage from the MRA will no longer be collected and pumped to the open pit, and will be allowed to passively discharge to the environment. The water quality of the runoff and seepage from the MRA will be monitored during the operations and closure phases to determine if the water quality is suitable for discharge. If the operational and closure monitoring determines that the water quality is not suitable for passive discharge to the environment, remedial action plans will be implemented, including collection and treatment, as required, until the water can be allowed to enter the environment without considerable adverse effects.

Changes to the drainage patterns across the Project footprint will also occur during post-closure phase stage II. The watercourse realignments between Clam Lake and Little Clam Lake will be decommissioned and the dam mitigating flow from Clam Lake into the pit catchment area will be breached. Furthermore, additional changes to the Project site hydrology will result from the decommissioning of the watercourse realignment between Bagsverd Lake (south) and Weeduck Lake, and from breaching the dam between the main and south part of Bagsverd Lake. These changes will direct the drainage from Clam Lake into the Côté Pit Lake, similar to pre-mining conditions. The surplus from the Côté Pit Lake will flow into Three Duck Lakes (upper). Weeduck Lake will become a headwater lake and continue to flow into Three Duck Lakes (upper). Little Clam Lake will also become a headwater lake, with the surplus reporting to Bagsverd Lake and then north through the realigned Bagsverd Creek system.

The drainage patterns for the remainder of the Project site during post-closure phase stage II are assumed to be consistent with post-closure phase stage II.

4.6.2 Surface Water Receivers

Predicted effects on receiving environment surface water quality were simulated by the post-closure phase stage II model at 12 locations. A summary of these results is discussed by watershed below.

Mollie River Watershed

The minimum and maximum monthly average concentrations taken from the results of average, 1:25-year dry and 1:25-year wet conditions for the locations in the Mollie River Watershed are compared to the 95th percentile baseline concentrations and Water Quality Guidelines in Table 4-7. The post-closure phase stage II includes an predictions of the water quality in the Côté Pit Lake, and excludes Bagsverd Lake (south), Little Clam Lake and Weeduck Lake; these three lakes have been excluded because of changes to the drainage patterns during post-closure phase stage II: 1) Bagsverd Lake is returned to a single water body within the Mesomikenda Lake Watershed, and 2) Little Clam Lake and Weeduck Lake return to being headwater lakes that only receive natural runoff.

Based on the predicted monthly average concentrations in the Mollie River Watershed during the post-closure phase stage II, the key results by location are as follows:



- Chester Lake – Calcium, cobalt, copper and potassium are predicted to be greater than the 95th percentile baseline concentrations, and barium, nickel and strontium are predicted to be intermittently greater than the 95th percentile baseline concentrations.
- Clam Lake – Calcium, cobalt, copper and potassium are predicted to be greater than the 95th percentile baseline concentrations, and barium, nickel, and strontium are predicted to be intermittently greater than the 95th percentile baseline concentrations.
- Côté Pit Lake – Barium, calcium, cobalt, copper, nickel, potassium, strontium and uranium are predicted to be greater than the 95th percentile baseline concentrations, and arsenic is predicted to be intermittently greater than the 95th percentile baseline concentrations. Phosphorous (total) concentrations are predicted to be intermittently greater than both the 95th percentile baseline concentrations and the Water Quality Guideline.
- Three Duck Lakes (upper/middle) – Calcium, copper and potassium are predicted to be greater than the 95th percentile baseline concentrations, and arsenic, barium, chloride, cobalt, magnesium, molybdenum, nickel, sodium, strontium, sulphate, uranium and vanadium are predicted to be intermittently greater than the 95th percentile baseline concentrations. Phosphorous (total) concentrations are predicted to be intermittently greater than both the 95th percentile baseline concentration and the Water Quality Guideline.
- Three Duck Lakes (lower) – Arsenic, barium, calcium, cobalt, copper, nickel, potassium, strontium, and uranium are predicted to be greater than the 95th percentile baseline concentrations. Phosphorous (total) concentrations are predicted to be continuously greater than both the 95th percentile baseline concentration and the Water Quality Guideline.
- Delaney Lake – Cobalt, copper and nickel are predicted to be greater than the 95th percentile baseline concentrations, and arsenic, barium, calcium, chloride, magnesium, manganese, molybdenum, potassium, sodium, strontium, sulphate, uranium and vanadium are predicted to be intermittently greater than the 95th percentile baseline concentrations. Phosphorous (total) concentrations are predicted to be intermittently greater than both the 95th percentile baseline concentration and the Water Quality Guideline.
- Dividing Lake – Arsenic, barium, calcium, cobalt, copper, nickel, potassium, strontium, and uranium are predicted to be marginally greater than the 95th percentile baseline concentrations. Phosphorous (total) concentrations are predicted to be continuously greater than both the 95th percentile baseline concentration and the Water Quality Guideline.

Overall, the water quality predicted throughout the post-closure phase stage II has higher concentrations within the Mollie River Watershed, as compared to those predicted for post-closure phase stage I. During post-closure phase stage II, the open pit is flooded to equilibrium levels, and as such, the water from the MRA is no longer being pumped to the open pit. The runoff and seepage from the MRA is assumed to be suitable for discharge to the environment due to the expected decrease in the mineral reaction rates over five (plus) decades of weathering. Furthermore, the water in the Côté Pit Lake is assumed to be suitable for discharge. The passive release of water from the MRA and Côté Pit Lake is the reason for the predicted increases in concentrations of some metals between the post-closure phase stages I versus II.

As with the operations phase and post-closure phase stage I, some metals during the post-closure phase stage II are predicted to occur in the Mollie River Watershed at concentrations that are above the upper limit of baseline concentrations (95th percentile baseline concentrations). However, the water quality predictions



suggest that no metals will occur at concentrations greater than both the 95th percentile baseline concentration and Water Quality Guidelines that are based on aquatic toxicological data. Only phosphorous is expected to occur at concentrations that are greater than both the 95th percentile concentrations and the Water Quality Guideline, which is an aesthetic water quality guideline. Furthermore, the concentrations of metals that are related to the weathering of the mine rock in the decommissioned MRA will gradually decrease over time; therefore, it is not expected that concentrations would continuously occur greater than the 95th percentile baseline concentrations throughout post-closure phase stage II (i.e., into perpetuity).

The monthly average concentrations of some metals are predicted to be greater than the 95th percentile baseline concentrations at the end of the Mollie River Watershed during post-closure phase stage II, and therefore perhaps extend beyond the LSA. However, similar to the operations phase and post-closure phase stage I, the extent of these concentrations is expected to be localized near the downstream end of the Mollie River Watershed.

Mesomikenda Lake Watershed

The minimum and maximum monthly average concentrations taken from the results of average, 1:25-year dry and 1:25-year wet conditions for the locations in the Mesomikenda Lake Watershed are compared to the 95th percentile baseline concentrations and Water Quality Guidelines in Table 4-8.

Based on the predicted monthly average concentrations in the Mesomikenda Lake Watershed during the post-closure phase stage II, the key results by location are as follows:

- Bagsverd Lake - Cobalt, copper, and nickel, are predicted to be greater than the 95th percentile baseline concentrations, and barium concentrations are predicted to be intermittently greater than the 95th percentile baseline concentrations.
- Un-named Lake #1 – Cobalt, copper, and nickel, are predicted to be greater than the 95th percentile baseline concentrations, and arsenic, barium, calcium, magnesium, manganese, molybdenum, potassium, sodium, strontium, sulphate, and uranium are predicted to be intermittently greater than the 95th percentile baseline concentrations.
- Bagsverd Creek – Cobalt and nickel are predicted to be greater than the 95th percentile baseline concentrations, and barium, calcium, copper, manganese, potassium, sodium, and sulphate are predicted to be intermittently greater than the 95th percentile baseline concentrations.
- Neville Lake – Copper is predicted to be greater than the 95th percentile baseline concentrations, and barium, calcium, cobalt, magnesium, nickel, potassium, sodium, and sulphate are predicted to be intermittently greater than the 95th percentile baseline concentrations.
- Mesomikenda Lake (upper) – Cobalt and nickel are predicted to be greater than the 95th percentile baseline concentrations, and barium, manganese, and potassium are predicted to be intermittently greater than the 95th percentile baseline concentrations.

Similar to the operations phase and post-closure phase stage I, some metals (cobalt, copper and nickel) are predicted to occur in the Mesomikenda Lake Watershed at concentrations that are above the upper limit of baseline concentrations throughout the post-closure phase stage II. However, for post-closure stage II, the



model predictions suggest that no parameters are expected to be greater than both the 95th percentile baseline concentrations and the Water Quality Guidelines at all locations in the Mesomikenda Lake Watershed.

The monthly average concentrations of some metals are predicted to be greater than the 95th percentile baseline concentrations at the outlet of the Mesomikenda Lake Watershed during post-closure phase stage II, and therefore could perhaps extend beyond the LSA. However, similar to the operations phase and post-closure phase stage I, the extent of these concentrations is expected to be localized near the downstream end of the Mesomikenda Lake Watershed.



TECHNICAL SUPPORT DOCUMENT: WATER QUALITY

Table 4-7: Monthly Average Concentrations for Locations in Mollie River Watershed, Post-closure Phase Stage II

Parameter	95 th Percentile Baseline Conc.	Water Quality Guidelines	Mollie River Watershed													
			Chester Lake		Clam Lake		Côté Pit Lake		Three Duck Lakes (Upper/Middle)		Three Duck Lakes (Lower)		Delaney Lake		Dividing Lake	
			Min	Max	Min	Max	Min	Max	Min	Max	Min	Max	Min	Max	Min	Max
Aluminum	0.12	0.075	0.040	0.055	0.046	0.053	0.051	0.053	0.038	0.075	0.049	0.054	0.048	0.10	0.051	0.054
Ammonia (Total)	0.21	6.9	0.038	0.055	0.046	0.053	0.048	0.052	0.034	0.070	0.046	0.051	0.051	0.10	0.049	0.052
Ammonia (Un-ion.)	0.00049	0.019	0.000025	0.00032	0.00003	0.00034	0.000030	0.00033	0.00002	0.00042	0.000030	0.00033	0.000040	0.00056	0.000030	0.00034
Antimony	0.006	0.02	0.00042	0.00068	0.00042	0.00060	0.00078	0.00089	0.00057	0.0012	0.00079	0.00094	0.00031	0.00088	0.00079	0.00090
Arsenic	0.003	0.005	0.0020	0.0027	0.0020	0.0025	0.0030	0.0034	0.0023	0.0046	0.0031	0.0035	0.0017	0.0042	0.0031	0.0034
Barium	0.007	1.0	0.0058	0.0074	0.0064	0.0072	0.0075	0.0080	0.0057	0.0112	0.0074	0.0082	0.0061	0.0134	0.0076	0.0081
Boron	0.01	1.5	0.0048	0.0063	0.0054	0.0061	0.0061	0.0064	0.0047	0.0091	0.0060	0.0066	0.0053	0.0114	0.0062	0.0065
Cadmium	0.00005	0.000058	0.000018	0.000024	0.000021	0.000023	0.000023	0.000024	0.000017	0.000034	0.000022	0.000024	0.000021	0.000045	0.000023	0.000024
Calcium	10	-	11	15	11	14	17	19	13	27	17	20	8.5	22	18	20
Chloride	1.2	120	0.84	1.0	0.85	1.0	1.1	1.2	0.85	1.7	1.1	1.3	0.77	1.8	1.1	1.2
Cobalt	0.00025	0.0025	0.00026	0.00034	0.00029	0.00033	0.00033	0.00035	0.00025	0.00049	0.00033	0.00036	0.00028	0.00061	0.00033	0.00036
Copper	0.001	0.005	0.0013	0.0016	0.0013	0.0015	0.0018	0.0019	0.0013	0.0027	0.0018	0.0020	0.0011	0.0027	0.0018	0.0020
Cyanide (Total) ⁽¹⁾	0.001	-	-	-	-	-	-	-	-	-	-	-	-	-	-	-
Cyanide (Free) ⁽¹⁾	-	0.0098	-	-	-	-	-	-	-	-	-	-	-	-	-	-
Iron	0.37	0.3	0.13	0.19	0.16	0.18	0.17	0.17	0.12	0.25	0.16	0.17	0.17	0.36	0.17	0.18
Lead	0.0005	0.003	0.000057	0.000071	0.000059	0.000069	0.000075	0.000080	0.000057	0.00011	0.000074	0.000083	0.000055	0.00013	0.000076	0.000082
Magnesium	2.0	-	1.2	1.6	1.4	1.6	1.5	1.6	1.1	2.2	1.5	1.6	1.4	3.0	1.5	1.6
Manganese	0.088	0.7	0.054	0.072	0.061	0.069	0.069	0.073	0.053	0.10	0.068	0.075	0.061	0.13	0.070	0.074
Molybdenum	0.002	0.073	0.0012	0.0015	0.0012	0.0014	0.0016	0.0018	0.0012	0.0025	0.0016	0.0018	0.0011	0.0025	0.0016	0.0018
Nickel	0.0015	0.025	0.0013	0.0018	0.0015	0.0017	0.0016	0.0017	0.0012	0.0024	0.0016	0.0017	0.0016	0.0033	0.0016	0.0017
Nitrate	0.13	13	0.048	0.069	0.057	0.066	0.060	0.070	0.043	0.087	0.058	0.070	0.063	0.13	0.060	0.071
Phosphorus (Total)	0.035	0.02	0.021	0.031	0.021	0.028	0.035	0.040	0.026	0.055	0.036	0.042	0.016	0.04	0.036	0.041
Potassium	0.49	373	0.56	0.87	0.56	0.77	1.00	1.13	0.74	1.5	1.0	1.2	0.42	1.2	1.0	1.2
Sodium	1.3	-	0.90	1.2	1.0	1.2	1.1	1.2	0.86	1.7	1.1	1.2	1.0	2.2	1.2	1.2
Strontium	0.026	-	0.022	0.029	0.022	0.027	0.033	0.037	0.025	0.050	0.033	0.038	0.019	0.05	0.034	0.037
Sulphate	4.1	218	2.9	3.8	3.2	3.7	3.7	3.9	2.8	5.5	3.6	4.0	3.2	6.9	3.7	4.0
Uranium	0.002	0.015	0.0014	0.0020	0.0014	0.0018	0.0022	0.0025	0.0017	0.0034	0.0023	0.0026	0.0012	0.0029	0.0023	0.0025
Vanadium	0.002	0.006	0.0012	0.0014	0.0012	0.0014	0.0015	0.0017	0.0012	0.0023	0.0015	0.0017	0.0011	0.0025	0.0016	0.0017
Zinc	0.032	0.02	0.0083	0.011	0.0093	0.010	0.011	0.011	0.0081	0.016	0.010	0.012	0.0092	0.020	0.011	0.011

Notes:
 Minimum (Min) and maximum (Max) monthly average concentrations are in mg/L.
 Monthly average concentrations greater than the 95th percentile baseline concentrations are denoted in bold, and monthly average concentrations greater than the 95th percentile baseline concentration and Water Quality Guidelines are denoted in bold and italics.
 (1) Total and free cyanide are not predicted for Mollie River Watershed locations, as there is assumed not to be a source of cyanide to this watershed.



Table 4-8: Monthly Average Concentrations for Locations in Mesomikenda Lake Watershed, Post-closure Phase Stage II

Parameter	95 th Percentile Baseline Conc.	Water Quality Guidelines	Mesomikenda Lake Watershed									
			Bagsverd Lake		Un-named Lake #1		Bagsverd Creek		Neville Lake		Mesomikenda Lake (Upper)	
			Min	Max	Min	Max	Min	Max	Min	Max	Min	Max
Aluminum	0.12	0.075	0.050	0.061	0.049	0.094	0.034	0.07	0.055	0.071	0.041	0.046
Ammonia (Total)	0.21	6.9	0.053	0.066	0.053	0.10	0.036	0.07	0.059	0.076	0.044	0.050
Ammonia (Un-ion.)	0.00049	0.019	0.000036	0.00040	0.00004	0.00060	0.00004	0.00043	0.00004	0.00047	0.00003	0.00033
Antimony	0.006	0.02	0.00027	0.00033	0.00027	0.00051	0.00027	0.00051	0.00018	0.00037	0.00030	0.00039
Arsenic	0.003	0.005	0.0016	0.0020	0.0016	0.0031	0.0011	0.0022	0.0018	0.0023	0.0014	0.0015
Barium	0.007	1.0	0.0062	0.0076	0.0062	0.0118	0.0062	0.0117	0.0042	0.0085	0.0068	0.0089
Boron	0.01	1.5	0.0054	0.0067	0.0054	0.010	0.0054	0.010	0.0037	0.0074	0.0060	0.0078
Cadmium	0.00005	0.000058	0.000022	0.000027	0.000021	0.000041	0.000021	0.000041	0.000015	0.000030	0.000024	0.000031
Calcium	10	-	7.9	9.7	7.8	15	5.4	11	8.7	11	6.6	7.3
Chloride	1.2	120	0.77	0.94	0.76	1.45	0.76	1.44	0.52	1.05	0.84	1.10
Cobalt	0.00025	0.0025	0.00029	0.00035	0.00028	0.00055	0.00029	0.00054	0.00020	0.00040	0.00032	0.00041
Copper	0.001	0.005	0.0011	0.0014	0.0011	0.0021	0.0008	0.0015	0.0012	0.0016	0.00093	0.0010
Cyanide (Total) ⁽¹⁾	0.001	-	-	-	-	-	-	-	-	-	-	-
Cyanide (Free) ⁽¹⁾	-	0.0098	-	-	-	-	-	-	-	-	-	-
Iron	0.37	0.3	0.18	0.23	0.18	0.35	0.13	0.25	0.20	0.26	0.15	0.17
Lead	0.0005	0.003	0.000055	0.000068	0.000055	0.000105	0.000055	0.000104	0.000038	0.000076	0.000061	0.000079
Magnesium	2.0	-	1.4	1.8	1.4	2.7	1.0	2.0	1.6	2.1	1.2	1.3
Manganese	0.088	0.7	0.062	0.077	0.062	0.119	0.062	0.117	0.043	0.086	0.069	0.090
Molybdenum	0.002	0.073	0.0011	0.0013	0.0011	0.0021	0.0011	0.0020	0.00074	0.0015	0.0012	0.0016
Nickel	0.0015	0.025	0.0016	0.0020	0.0016	0.0031	0.0016	0.0031	0.0011	0.0022	0.0018	0.0023
Nitrate	0.13	13	0.066	0.082	0.066	0.13	0.045	0.091	0.073	0.095	0.055	0.062
Phosphorus (Total)	0.035	0.02	0.014	0.018	0.014	0.027	0.010	0.020	0.016	0.021	0.012	0.013
Potassium	0.49	373	0.37	0.46	0.37	0.71	0.37	0.70	0.25	0.51	0.41	0.53
Sodium	1.3	-	1.1	1.3	1.1	2.0	0.74	1.5	1.2	1.5	0.90	1.0
Strontium	0.026	-	0.018	0.023	0.018	0.035	0.013	0.025	0.020	0.026	0.015	0.017
Sulphate	4.1	218	3.3	4.0	3.2	6.2	2.2	4.5	3.6	4.7	2.7	3.0
Uranium	0.002	0.015	0.0011	0.0013	0.0011	0.0021	0.00074	0.0015	0.0012	0.0016	0.00090	0.0010
Vanadium	0.002	0.006	0.0011	0.0013	0.0011	0.0021	0.00074	0.0015	0.0012	0.0016	0.00090	0.0010
Zinc	0.032	0.02	0.0094	0.012	0.0093	0.018	0.0065	0.013	0.010	0.014	0.0079	0.0088

Notes:

Minimum (Min) and maximum (Max) monthly average concentrations are in mg/L.

Monthly average concentrations greater than the 95th percentile baseline concentrations are denoted in bold, and monthly average concentrations greater than the 95th percentile baseline concentration and Water Quality Guidelines are denoted in bold and italics.

(1) Total and free cyanide are not predicted for Mesomikenda Lake Watershed locations during post-closure phase stage II, as there is assumed not to be a source of cyanide to this system 50 to 80 years after closure of the Project site.



5.0 MITIGATION AND MONITORING

5.1 Mitigation

The prediction of water quality effects was completed based on several inherent mitigation measures that have been included in the design of the Project. These include:

- Engineered facilities will be constructed to store mine rock (MRA), low-grade ore (low-grade stockpile) and tailings (TMF).
- Engineered water management systems will be constructed to collect runoff and seepage from the MRA, low-grade stockpile, TMF, and polishing pond during the operations phase, closure phase and post-closure phase stage I.
- Contact water that is comprised of inflows and runoff from the pit walls, runoff and seepage from the MRA and low grade stockpiles, and runoff from the plant site will be collected and pumped to the mine water pond during the operations phase and pumped to the open pit during the post-closure phase stage I. During all Project phases, contact water from the MRA, low-grade stockpile, open pit, and TMF will be monitored to determine suitability prior to being discharged to the environment.
- Contact and process water contained within the collection ponds adjacent to the TMF and polishing ponds will be pumped back into the reclaim pond and polishing pond, respectively, during the operations phase.
- A low-permeable liner will be installed at the mine water pond.
- Erosion and sediment control will be implemented through BMPs and engineering design to limit erosion and mobilization of sediments, promote settling of sediments and mitigate the migration of suspended solids into nearby surface water features. BMPs for erosion and sediment control include: the use of earthwork methods to minimize slope length and grade, ditching, sediment ponds/traps, flocculent plant (contingency use only), channel and slope armouring, use of natural vegetation buffers, re-vegetation of disturbed soil, and runoff controls (i.e., sediment fencing and small check dams).
- Process water will be treated at the process plant for cyanide, cyanide destruction constituents (i.e., ammonia and copper) and other dissolved metals prior to discharge into the TMF.
- Effluent will be treated to meet federal and provincial metal mining sector effluent limits prior to being discharged to the environment.
- Sewage will be treated to a quality that meets federal and provincial legislative requirements before discharge to the environment.
- Solid domestic and industrial waste will be placed into a landfill that will be operated in accordance with federal and provincial legislative requirements, and BMPs, including mitigation, monitoring, remedial action, and closure plans, will be integrated into the operation and closure of the landfill.
- Explosive use BMPs will be implemented to reduce the blast waste rate and residual explosives present in the open pit, mine rock and low-grade ore available for contact with water.
- Spill clean-up action plans will be developed and implemented, as required, to isolate and properly dispose of contaminants.



5.2 Monitoring

Considering the potential effects of the Project on water quality, monitoring programs pertinent to water quality will be implemented during the construction, operations, closure and post-closure phases of the Project. The purpose of the monitoring program is to confirm the results of the effects predictions presented herein, and to provide a basis for future decision making regarding the environmental management of the Project.

The monitoring plan will evaluate water quality, and aspects strongly linked to water quality, and will include:

- water quality of surface water, groundwater, seepage water, and water from the Project site components; and
- sediment quality of lake and watercourse bottom sediments.

In addition, supplementary geochemistry work, including further test work to better understand the acid generation/neutralization and metal leaching characteristics of mine rock and tailings, will be carried out to confirm the geochemistry assumptions in the water quality modelling.

The network of monitoring stations will be selected to include locations on the Project site, as well as upstream and downstream of key Project site components, as required. The monitoring campaigns will include general site inspections of the Project site components to record observations pertinent to water and sediment quality. The documentation of general observations recorded during the general site inspections, along with the analytical results of the monitoring program, will assist with the ongoing management of monitoring program through the construction, operations, closure and post-closure phases of the Project.

The water and sediment quality monitoring programs are to be integrated with the monitoring programs developed for the hydrogeology, hydrology, aquatic biology and terrestrial ecology disciplines and documented within their respective TSDs, which have been submitted under separate cover as part of the EIS Report. The result of the water quality monitoring program will be integrated with the results obtained from the other disciplines on an annual basis, and the results will be evaluated in consideration of ongoing operational activities.

The surface water, groundwater, and sediment monitoring programs are discussed in greater detail below. The monitoring programs that are discussed below will undergo regular reviews, including an evaluation of the need for station locations, parameters (listed in the sections below) and frequency of sampling. Future changes to the monitoring programs will therefore be evaluated, and changes may result in streamlining the programs to focus on particular site-specific concerns or requirements.

5.2.1 Surface water

The baseline surface water quality monitoring program has been underway since September 2011, and, although not all of the 2013 results are reported in this Water Quality TSD, monitoring has been completed for the full year of 2013. Similar to the results presented herein (to May 2013), the frequency of baseline sampling events has been completed on a quarterly to monthly basis, depending on the station location, to measure the water quality within the LSA under a range of flow conditions. This baseline water quality monitoring program will continue during 2014, and will include lake profiles to evaluate the potential for lake stratification under fall and winter conditions.



Surface water quality will be monitored during all Project phases at a network of locations that will largely reflect those already being sampled as part of the baseline programs, and will initially include all locations discussed herein and also stations downstream of the LSA (i.e., downstream of Mesomikenda Lake and Dividing Lake). The surface water quality station locations will be regularly evaluated to determine each station's significance; for example, once the final Project configuration has been designed and construction is complete, the locations of the water quality monitoring stations may need to be revised to reflect any changes versus those presented in the Project Description. In addition, surface water monitoring stations will be added to collect samples from the open pit, MRSPs, TDSPs, mine water pond, reclaim pond, polishing pond (i.e., final treated effluent discharge point) and domestic sewage effluent. The occurrence of sampling events will be completed at a frequency sufficient to detect changes in water quality; the frequency will therefore depend on the station location and will aim capture a range of flow conditions, as required. The frequency of effluent monitoring will meet federal and provincial effluent discharge requirements (as per MMER and O.Reg. 560/94).

The surface water samples will be analyzed for the following parameters:

- general parameters – temperature, pH, alkalinity, acidity, conductivity, hardness, dissolved oxygen, oxygen-reduction potential (ORP), total suspended solids, total dissolved solids, dissolved organic carbon, total organic carbon, biological oxygen demand (BOD), chemical oxygen demand (COD);
- major ions – calcium, chloride, fluoride, magnesium, potassium, sodium, sulphate;
- metals (total and dissolved) – aluminum, antimony, arsenic, barium, beryllium, bismuth, boron, cadmium, chromium, cobalt, copper, iron, lead, lithium, manganese, mercury, methyl mercury, molybdenum, nickel, selenium, silicon, silver, strontium, thallium, tin, titanium, tungsten, uranium, vanadium, zinc, zirconium;
- nutrients – nitrate, nitrite, total ammonia, phosphate, phosphorus;
- cyanide species – total, free, weakly acid dissociable (WAD) cyanide; and
- radionuclide parameters – radium-226.

In addition, analysis for organic contaminants (i.e., oil and grease, phenols and polycyclic aromatic hydrocarbons) will be completed at select stations and during select sampling rounds; the stations will be determined based on the potential of a source term for these contaminants and the frequency of analyzing for organic contaminants will be reduced, if concentrations are regularly below the method detection limits. Measurements of temperature, pH, conductivity, dissolved oxygen, oxygen-reduction potential will be completed in the field. The method detection limits for the above surface water quality parameters will be low enough for comparison to federal and provincial water quality guidelines.

The surface water quality monitoring plan will be executed in conjunction with the aquatic monitoring plan, as described in the Aquatic Biology TSD.

5.2.2 Groundwater

Groundwater quality will be monitored during all Project phases at a network of monitoring wells that will be installed during the construction, operations and closure phases of the Project, as required. Nested monitoring wells will be installed downgradient of the MRA, low-grade stockpile, TMF, polishing pond and nearby landfill. The occurrence of sampling events will be completed on a basis that is sufficient to detect changes in water



quality; the frequency will depend on the monitoring well locations and will aim to capture a range of flow conditions.

The groundwater samples will be analyzed for the following parameters:

- general parameters – temperature, pH, alkalinity, acidity, conductivity, hardness, dissolved oxygen, oxygen-reduction potential (ORP), total dissolved solids, dissolved organic carbon, total organic carbon;
- major ions – calcium, chloride, fluoride, magnesium, potassium, sodium, sulphate;
- metals (dissolved) – aluminum, antimony, arsenic, barium, beryllium, bismuth, boron, cadmium, chromium, cobalt, copper, iron, lead, lithium, manganese, mercury, molybdenum, nickel, selenium, silicon, silver, strontium, thallium, tin, titanium, tungsten, uranium, vanadium, zinc, zirconium;
- nutrients – nitrate, nitrite, total ammonia, phosphate, phosphorus; and
- cyanide species – total, free, weakly acid dissociable (WAD) cyanide.

In addition, analysis for organic contaminants (i.e., oil and grease, phenols and polycyclic aromatic hydrocarbons) will be completed at select stations and during only select sampling rounds; the stations will be determined based on the potential of a source term for these contaminants and the frequency of analyzing for organic contaminants will be reduced, if concentrations are regularly below the method detection limits. Measurements of temperature, pH, conductivity, dissolved oxygen, oxygen-reduction potential will be completed in the field. The method detection limits for the above groundwater quality parameters will be similar to those for the surface water quality analyses.

The groundwater quality monitoring plan will be executed in conjunction with the hydrogeology monitoring plan, as described in the Hydrogeology TSD.

5.2.3 Sediment

Predictions of effects on sediment quality were not specifically developed, but are, however, implicitly considered as part of the water quality effects predictions. Potential changes in sediment quality can be caused by changes in water quality; therefore, monitoring of sediment quality will be performed to confirm there are no changes related to the expected water quality effects. Sediment samples will be collected from lakes where changes to water quality are expected, and at a frequency sufficient to evaluate potential changes in sediment quality over time.

The sediment samples will be analyzed for the following parameters:

- major ions – calcium, magnesium, potassium, sodium;
- metals – aluminum, antimony, arsenic, barium, beryllium, bismuth, boron, cadmium, chromium, cobalt, copper, iron, lead, lithium, manganese, mercury, molybdenum, nickel, selenium, silicon, silver, strontium, thallium, tin, titanium, tungsten, uranium, vanadium, zinc, zirconium;
- nutrients – total nitrogen, total phosphorus; and
- other – carbonate, organic carbon, sulphate, sulphide, particle size, total cyanide.



The method detection limits for the above sediment quality parameters will be low enough for comparison to federal and provincial water quality guidelines.

The sediment quality monitoring plan will be executed in conjunction with the aquatic monitoring plan, as described in the Aquatic Biology TSD.

6.0 CONCLUSIONS

A water quality effects assessment was completed that included a characterization of existing conditions and predictions of effects to water quality. The existing surface water and groundwater quality is typical of lakes and watercourses that are present within the Canadian Shield geological region, and is generally characterized as slightly acidic to near-neutral pH conditions and occasional occurrences of some parameters (including aluminum, copper, iron, phosphorus, zinc, cadmium, lead, silver, thallium and free cyanide) greater than aquatic guidelines.

Project activities, and associated Project components, that were included as part of the water quality predictions are: mining of the open pit, stockpiling rock into the MRA and low-grade stockpile, use of explosives, deposition of tailings into the TMF, generation of process water by the process plant, and discharge of treated effluent. The potential for these Project activities to affect water quality in the surface water receiving environment, which are located within the defined spatial boundaries, were evaluated using predictive numerical modelling for the operations and post-closure phases. Potential effects to water quality during the construction and closure phases are discussed qualitatively and relative to the results for the operations and post-closure phases, where appropriate.

Based on the effects predictions (i.e., water quality modelling), the key conclusions of the water quality effects predictions are as follows:

- 1) During the construction phase, the Project components are not expected to be developed sufficiently to influence site water quality; therefore, with the implementation of BMPs for sediment and erosion control, the water quality of the surface water receivers is expected to remain within the range of concentrations observed under existing conditions.
- 2) During the operations, closure and post-closure phase stage I, monthly average concentrations of major ions and some metals are predicted to be continuously to intermittently greater than the 95th percentile baseline concentrations in the following surface water features:
 - a. Mollie River Watershed: Three Duck Lakes, Delaney Lake, and to a lesser extent Chester Lake, Clam Lake, Little Clam Lake, Weeduck Lake and Dividing Lake.
 - b. Mesomikenda Lake Watershed: Un-named Lake #1, Bagsverd Creek, Neville Lake, and to a lesser extent Bagsverd Lake and Mesomikenda Lake (upper).
- 3) Cyanide is predicted to be greater than the 95th percentile baseline concentrations in Bagsverd Lake, Un-named Lake #1, Bagsverd Creek, Neville Lake (lower) and Mesomikenda Lake (upper) during the operations phase, closure phase and the early stage of post-closure phase.



- 4) During the post-closure phase stage II, monthly average concentrations of major ions and some metals are predicted to be continuously to intermittently greater than the 95th percentile baseline concentrations in the following surface water features:
 - a. Mollie River Watershed: Côté Pit Lake, Three Duck Lakes, Delaney Lake, and to a lesser extent Chester Lake, Clam Lake, and Dividing Lake.
 - b. Mesomikenda Lake Watershed: Un-named Lake #1, and to a lesser extent Bagsverd Lake, Bagsverd Creek, Neville Lake, and Mesomikenda Lake (upper).
- 5) Although model predictions infer that concentrations will increase to above the upper range of baseline for some parameters, monthly average concentrations during all Project phases for parameters greater than the 95th percentile baseline concentrations, with the exception of phosphorous, are predicted to be less than the Water Quality Guidelines. Phosphorous is predicted to be greater than both the 95th percentile baseline concentrations and the Water Quality Guideline in some lakes during each of the Project phases; noting that the phosphorous Water Quality Guideline is based on an aesthetic objective and not a guideline that is directly based on aquatic toxicological data.
- 6) Monthly average concentrations of some metals are predicted to be greater than the 95th percentile baseline concentrations at the outlet of the Mollie River and Mesomikenda Lake Watersheds during the operations, closure and post-closure phases; this suggests the possibility that concentrations are marginally greater than the 95th percentile baseline concentration and may persist within a localized area near the downstream end of the Mollie River and Mesomikenda Lake Watersheds.

7.0 REFERENCES

- British Columbia Ministry of the Environment. 2013. British Columbia Water Quality Guidelines (BCWQG). Available online at: http://www.env.gov.bc.ca/wat/wq/wq_guidelines.html. Accessed on December 2, 2013.
- Canadian Council of Ministers of the Environment. 2013. Canadian Water Quality Guidelines for the Protection of Aquatic Life. Available online at: <http://st-ts.ccme.ca/>. Accessed on December 2, 2013.
- Golder Associates Ltd. 2013. Côté Gold Project, Draft Environmental Assessment Report, Technical Support Document: Hydrology. November 2013.
- Health Canada. 2012. Guidelines for Canadian Drinking Water Quality Summary Table. Available online at: http://www.hc-sc.gc.ca/ewh-semt/pubs/water-eau/2012-sum_guide-res_recom/index-eng.php. Accessed on December 2, 2013.
- Ontario Ministry of the Environment. 2003. Technical Support Document for Ontario Drinking Water Standards Objectives and Guidelines.
- Ontario Ministry of Environment and Energy. 1999. Provincial Water Quality Objectives, PIBS 3303E, Queen's Printer for Ontario. July 1994, reprinted February 1999.



Government of Canada. 2013. Metal Mining Effluent Regulations (SOR/2002-222), last amended on 2012-03-02. Available on-line at: <http://laws-lois.justice.gc.ca/eng/regulations/SOR-2002-222/>. Accessed on December 2, 2013.

Water Environment Research Foundation. 2007. Scientific Review of Cyanide Ecotoxicology and Evaluation of Ambient Water Quality Criteria. WERF Report 01-ECO-1.



Report Signature Page

GOLDER ASSOCIATES LTD.

Mike Gunsinger, M.Sc., P. Geo.
Associate/Hydrogeochemist

John M. Petrie, M.Sc., P. Geo.
Principal

MRG/KAB/JMP/NK/ls

Golder, Golder Associates and the GA globe design are trademarks of Golder Associates Corporation.

n:\active\2013\1190 sudbury\1192\13-1192-0021 iamgold cote gold project timmins\3. water quality\reporting\tsd\13-1192-0021r rpt 14nov10 revised iamgold wq tsd.docx

Path: Z:\Projects\2013\13-1192-0021\GIS\MXDs\Reporting\Hydrogeology\TSD\Figure1-1_Project_Location.mxd

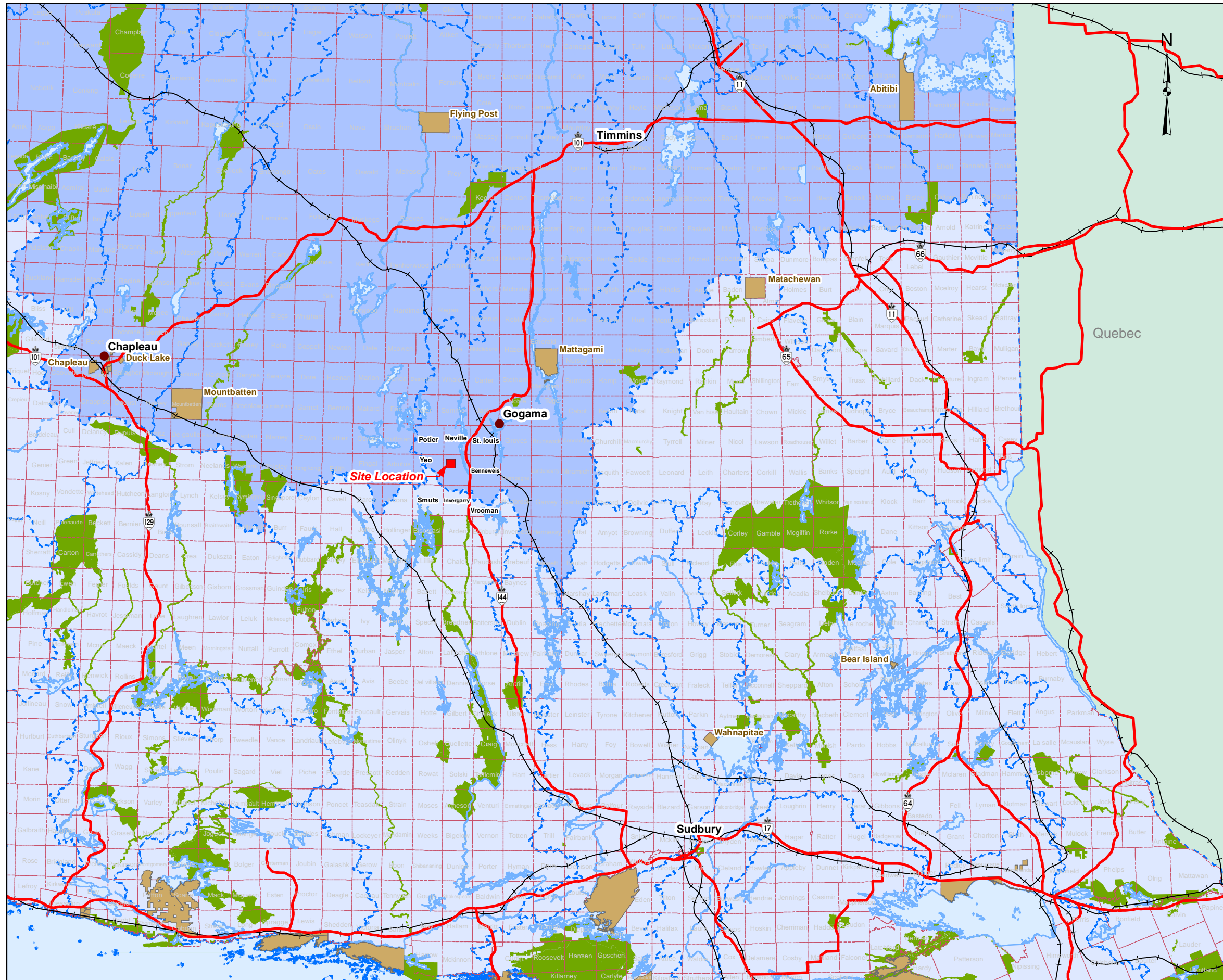

LEGEND

- Populated Places
- Major Roads
- Railway
- First Nations Communities
- Townships
- Provincial Park
- Primary Watersheds**
- Hudson Bay
- Great Lakes

REFERENCE

Base Data - MNR NRVIS, CANMAP v2008.4
 Produced by Golder Associates Ltd under licence from
 Ontario Ministry of Natural Resources, © Queens Printer 2012
 Projection: Transverse Mercator Datum: NAD 83 Coordinate System: UTM Zone 17

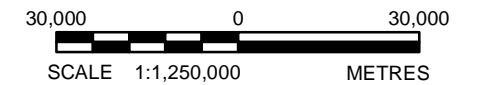

PROJECT		IAMGOLD CÔTÉ GOLD PROJECT	
TITLE		Project Location	
 Golder Associates Sudbury, Ontario	PROJECT No. 13-1192-0021	SCALE AS SHOWN	REV. 0
	DESIGN	RRD	Dec. 2012
	GIS	RRD	Oct. 2013
	CHECK	MO	Oct. 2013
	REVIEW	JMP	Nov. 2013
			FIGURE: 1-1

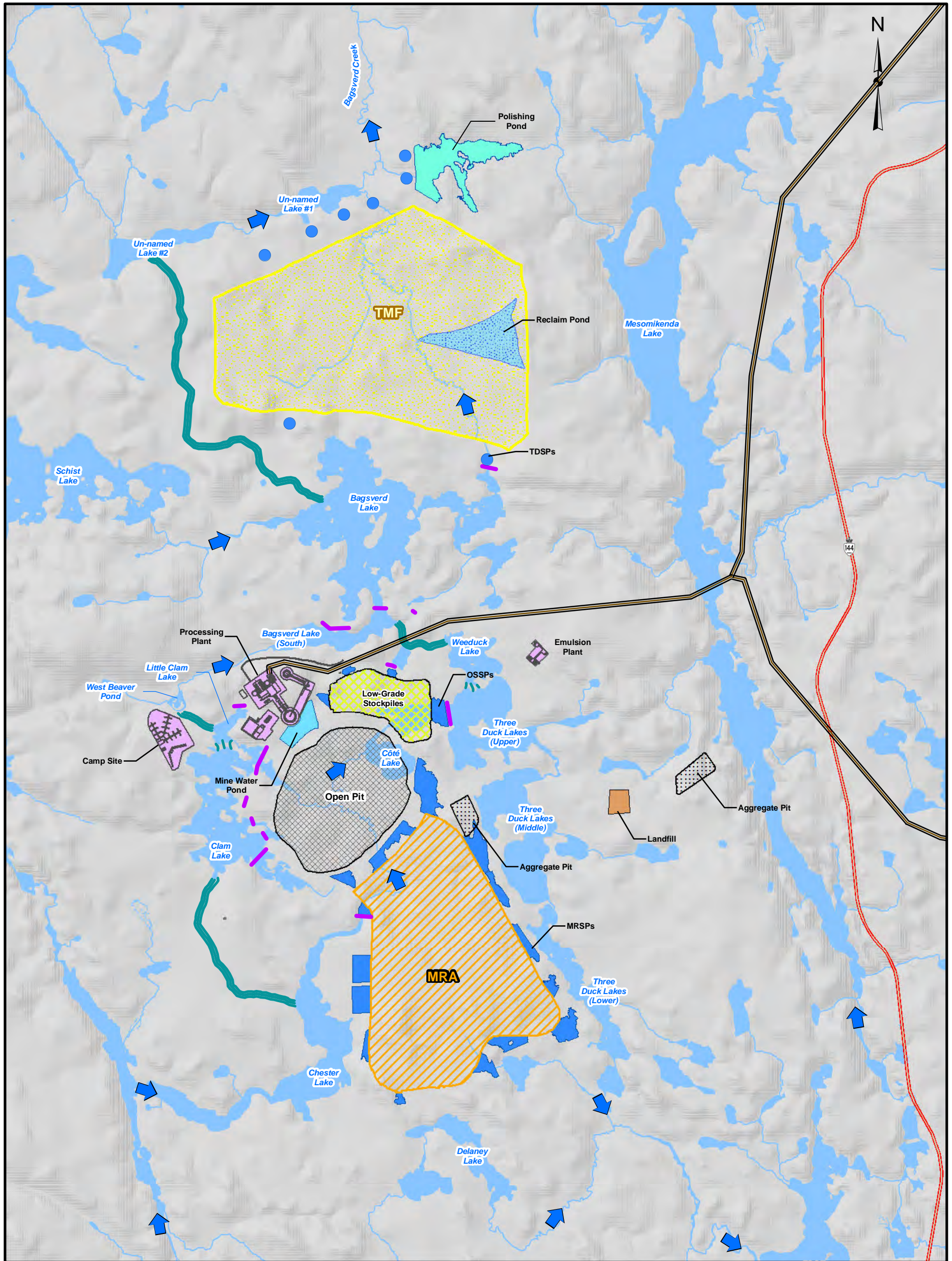

LEGEND

- Highway 144
- Realignment Dams
- Transmission Line
- Watercourse Realignment
- Low-Grade Stockpiles
- Mine Rock Area (MRA)
- Tailings Management Facility (TMF)
- Open Pit
- Polishing Pond
- Reclaim Pond
- Aggregate Pit
- Facilities
- Mine Water Pond
- Landfill
- Collection Ponds
- Waterbodies
- Creek / River
- ➔ Surface Water Flow Direction

NOTE:

Project site components are based on the ultimate extents of these facilities. (End of operations phase)

REFERENCE

Open Pit Shell provided by IAMGOLD, May 2013
 Base Data - MNR NRVIS, CANMAP v2008.4
 Produced by Golder Associates Ltd under licence from Ontario Ministry of Natural Resources,
 © Queens Printer 2013
 Projection: Transverse Mercator Datum: NAD 83 Coordinate System: UTM Zone 17

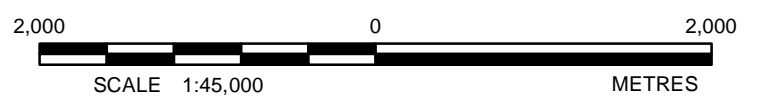

PROJECT		IAMGOLD CÔTÉ GOLD PROJECT	
TITLE		Site Plan	
PROJECT No. 13-1192-0021		SCALE AS SHOWN	REV. 0
DESIGN	RRD	Feb. 2013	FIGURE: 1-2
GIS	AL	Oct. 2013	
CHECK	MO	Oct. 2013	
REVIEW	JMP	Nov. 2013	



Path: Z:\Projects\2013\13-1192-0021\GIS\MXDs\Reporting\GeoChemistry\TSD\Figure1-2_Site_Plan.mxd

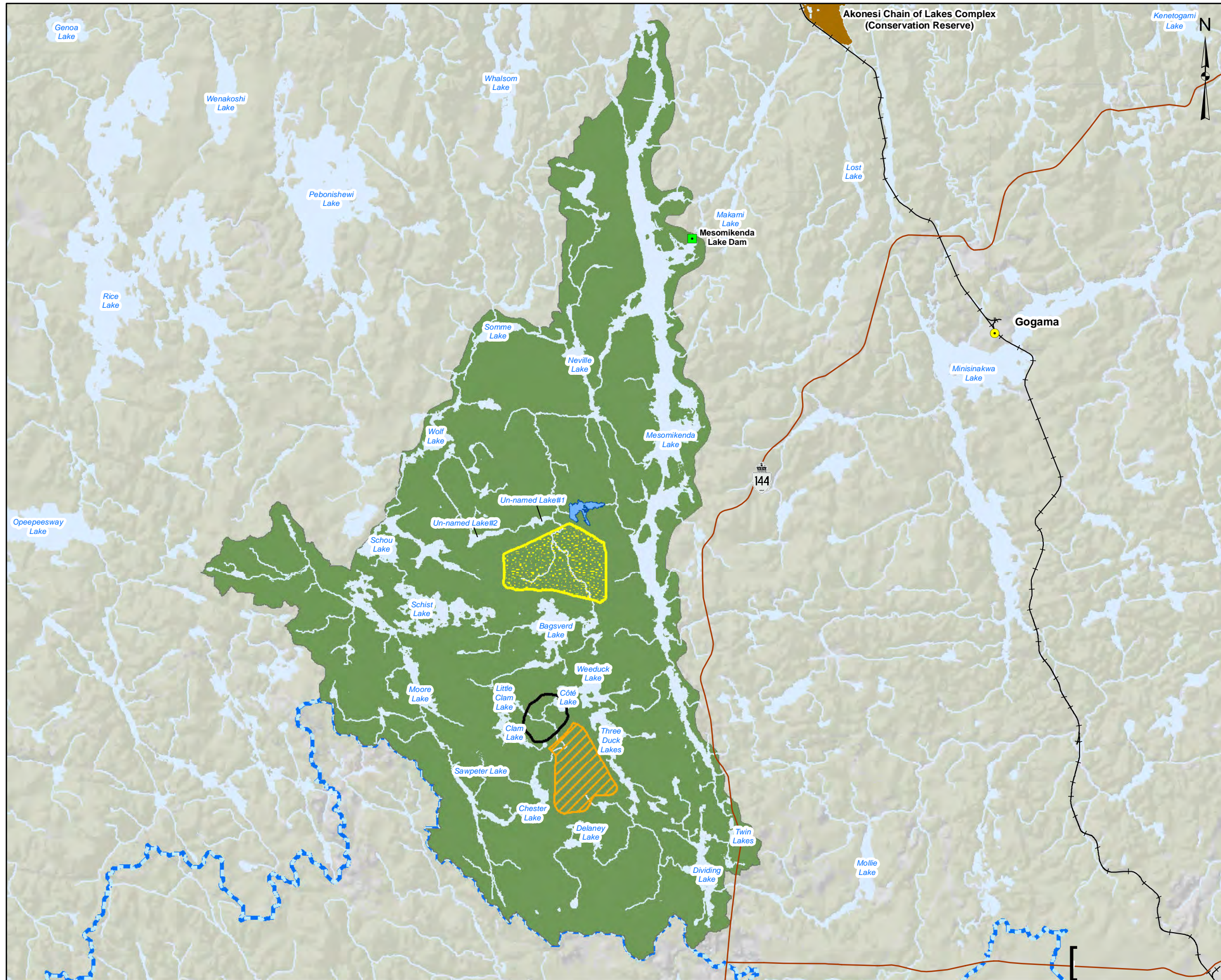

LEGEND

- Dams
- Major Roads
- Railway
- Mine Rock Area (MRA)
- Polishing Pond
- Tailings Management Facility (TMF)
- Open Pit
- Water Quality Local Study Area (LSA)
- Conservation Reserve (Regulated)
- Rivers
- Waterbody / Large Watercourse
- Arctic/Atlantic Watershed Divide

REFERENCE

IAMGOLD Open Pit, May 2013.
 Base Data - MNR NRVIS, CANMAP v2008.4
 Produced by Golder Associates Ltd under licence from
 Ontario Ministry of Natural Resources, © Queens Printer 2012
 Projection: Transverse Mercator Datum: NAD 83 Coordinate System: UTM Zone 17

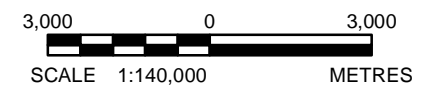

PROJECT		CÔTÉ GOLD PROJECT	
TITLE		Water Quality Local Study Area	
 Sudbury, Ontario	PROJECT No. 13-1192-0021	SCALE AS SHOWN	REV. 0
	DESIGN RRD Dec. 2012	FIGURE: 2-1	
	GIS RRD July 2013		
	CHECK NK Dec. 2013		
REVIEW MG Dec. 2013			

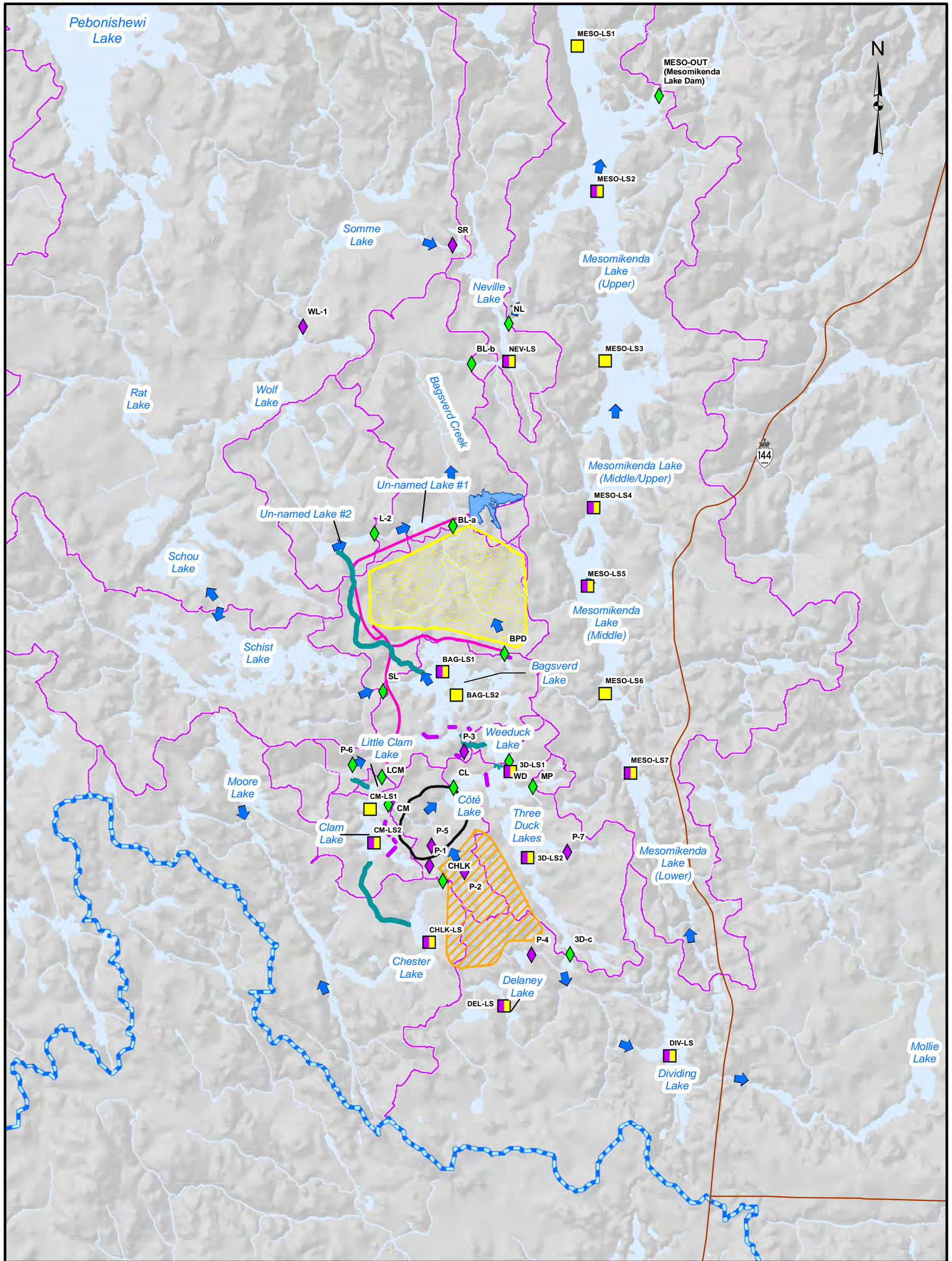

LEGEND

- Water Column Profile Location (with sample)
- Water Column Profile Location
- Watercourse Quality Monitoring Location (Monthly)
- Watercourse Quality Monitoring Location (Quarterly)
- Flow Direction
- Major Roads
- Railway
- Watercourse Realignment
- Tailings and Reclaim Pipeline
- Realignment Dams
- Polishing Pond
- Tailings Management Facility (TMF)
- Mine Rock Area (MRA)
- Open Pit
- Waterbodies
- Creek / River
- James Bay/Great Lakes Watershed Divide
- Existing Watersheds

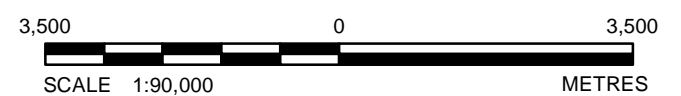

REFERENCE

Open Pit Shell provided by IAMGOLD, May 2013
 Base Data - MNR NRVIS, CANMAP v2008.4
 Produced by Golder Associates Ltd under licence from
 Ontario Ministry of Natural Resources, © Queens Printer 2013
 Projection: Transverse Mercator Datum: NAD 83 Coordinate System: UTM Zone 17

PROJECT
IAMGOLD CÔTÉ GOLD PROJECT

TITLE
Surface Water Quality Monitoring Stations



PROJECT No. 13-1192-0021			SCALE AS SHOWN	REV. 0
DESIGN	RRD	Dec. 2012	FIGURE: 2-2	
GIS	AL	Oct. 2013		
CHECK	NK	Jan. 2014		
REVIEW	MRG	Jan. 2014		

Z:\Projects\2013\13-1192-0021\GIS\MXDs\Reporting\GeoChemistry\TSDI\Figure_2_2_SurfaceWaterQualityMonitoringStations.mxd

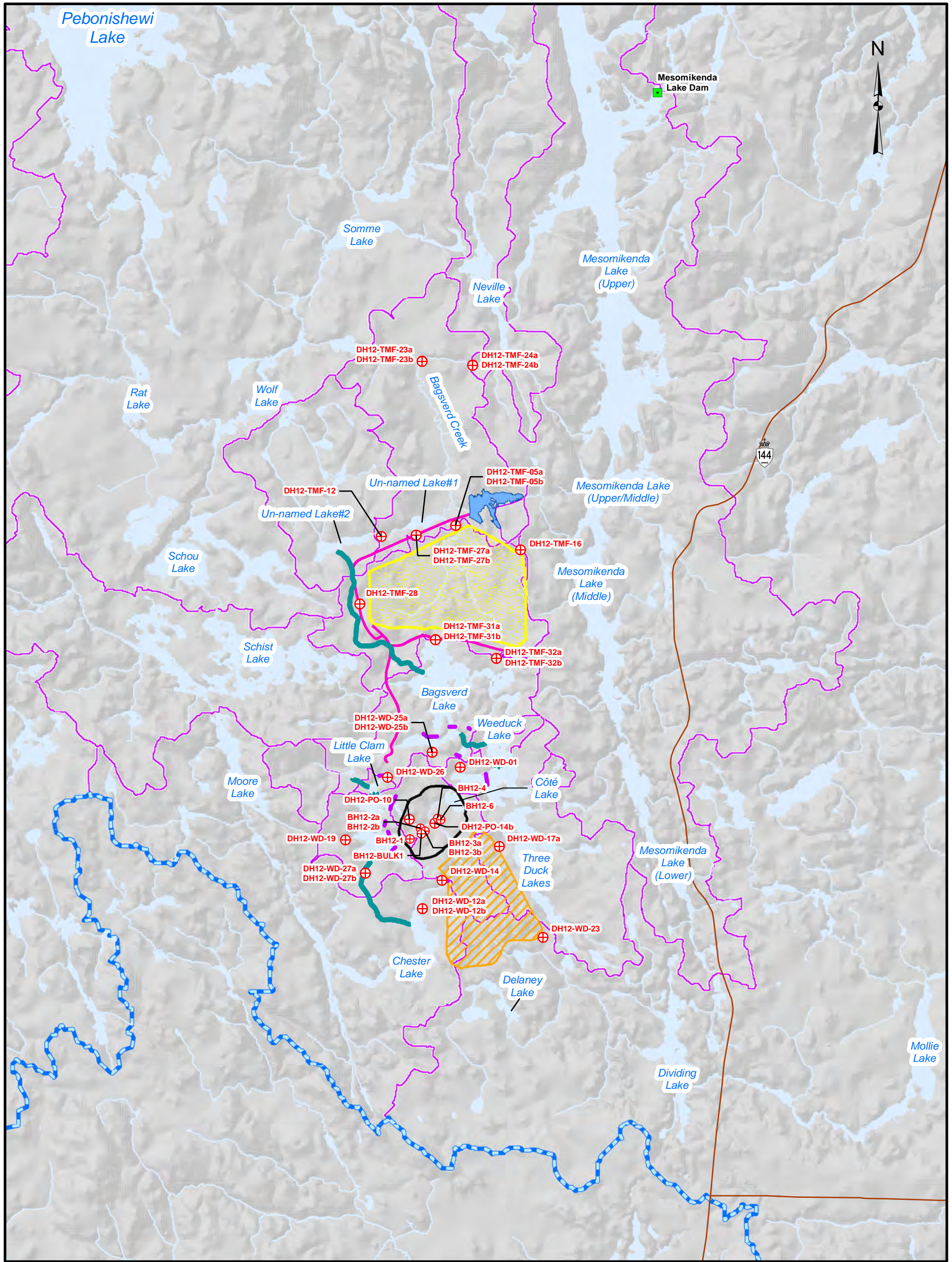

LEGEND

- ⊕ Groundwater Monitoring Well
- Dams
- Major Roads
- Railway
- Watercourse Realignment
- Tailings and Reclaim Pipeline
- Realignment Dams
- Polishing Pond
- Tailings Management Facility (TMF)
- Mine Rock Area (MRA)
- Open Pit
- Waterbodies
- Creek / River
- James Bay/Great Lakes Watershed Divide
- Existing Watersheds

REFERENCE

Open Pit Shell provided by IAMGOLD, May 2013
 Base Data - MNR NRVIS, CANMAP v2008.4
 Produced by Golder Associates Ltd under licence from
 Ontario Ministry of Natural Resources, © Queens Printer 2013
 Projection: Transverse Mercator Datum: NAD 83 Coordinate System: UTM Zone 17

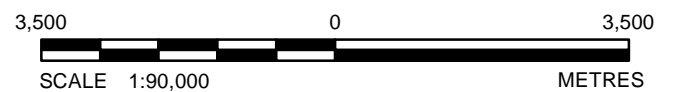

PROJECT		IAMGOLD CÔTÉ GOLD PROJECT	
TITLE		Groundwater Quality Monitoring Stations	
PROJECT No. 13-1192-0021		SCALE AS SHOWN	REV. 0
DESIGN	RRD	Dec. 2012	FIGURE: 2-3
GIS	AL	Oct. 2013	
CHECK	NK	Jan. 2014	
REVIEW	MRG	Jan. 2014	



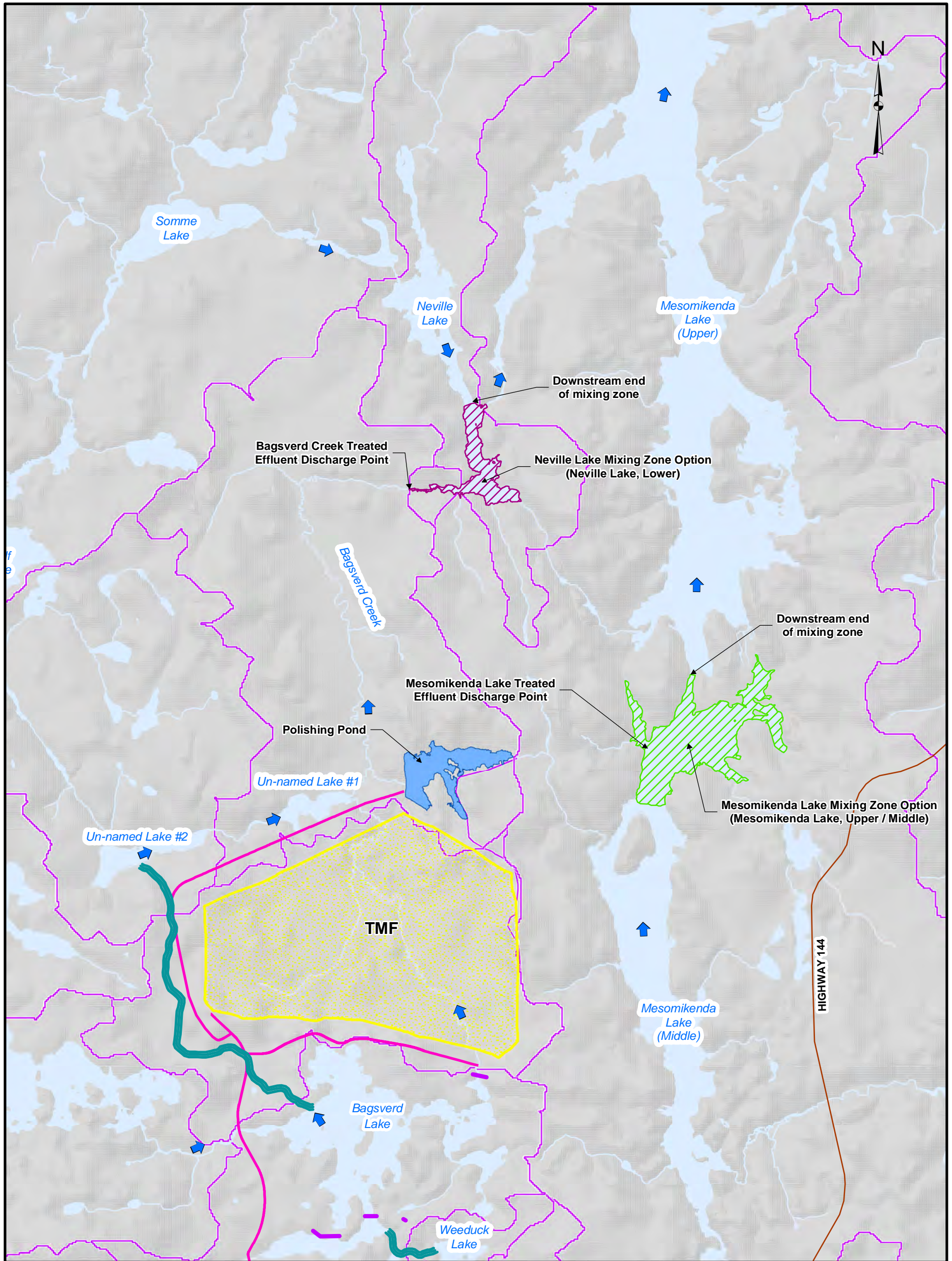

LEGEND

- Flow Direction
- Major Roads
- Railway
- Watercourse Realignment
- Tailings and Reclaim Pipeline
- Realignment Dams
- Mesomikenda Lake Mixing Zone Option
- Neville Lake Mixing Zone Option
- Polishing Pond
- Tailings Management Facility (TMF)
- James Bay/Great Lakes Watershed Divide
- Existing Watersheds
- Waterbodies
- Creek / River

REFERENCE

Open Pit Shell provided by IAMGOLD, May 2013
 Base Data - MNR NRVIS, CANMAP v2008.4
 Produced by Golder Associates Ltd under licence from
 Ontario Ministry of Natural Resources, © Queens Printer 2013
 Projection: Transverse Mercator Datum: NAD 83 Coordinate System: UTM Zone 17

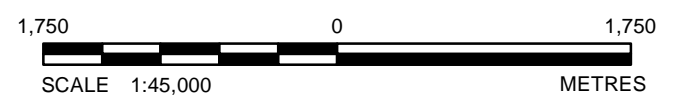

PROJECT		IAMGOLD CÔTÉ GOLD PROJECT	
TITLE		Treated Effluent Discharge Alternatives Analysis: Conceptual Mixing Zones	
PROJECT No. 13-1192-0021		SCALE AS SHOWN	REV. 0
DESIGN	RRD	Dec. 2012	FIGURE: 2-4
GIS	AL	Oct. 2013	
CHECK	NK	Jan. 2014	
REVIEW	MRG	Jan. 2014	



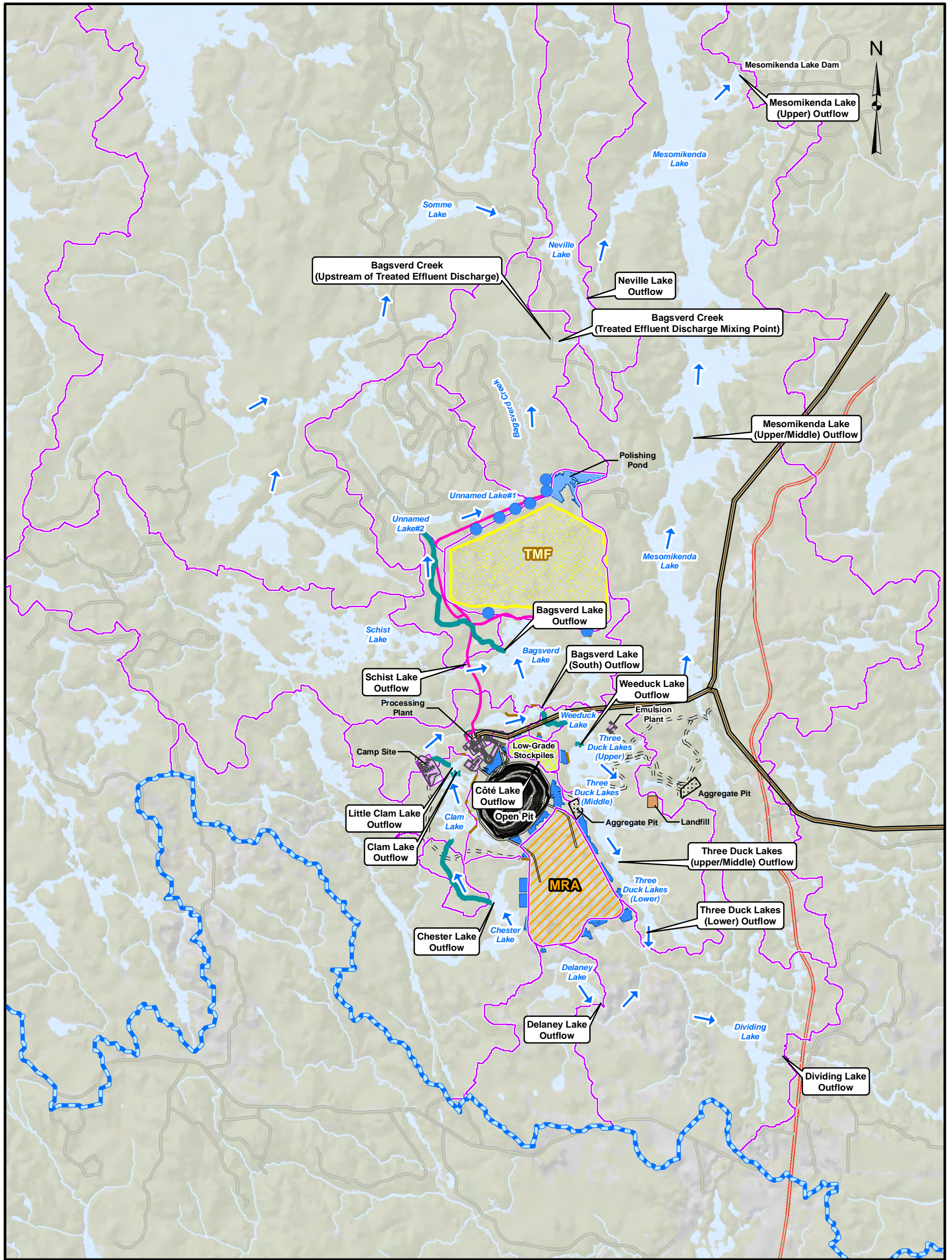

LEGEND

- Transmission Line
- Watercourse Realignment
- Tailings and Reclaim Pipeline
- Realignment Dams
- Aggregate Pit
- Landfill
- Facilities
- Arctic/Atlantic Watershed Divide
- Infrastructure Watersheds
- Pit Limit
- Polishing Pond
- Ore Stockpile
- Tailings Management Facility (TMF)
- Mine Rock Area (MRA)
- Regional Roads
- Highway 144
- Site Access Roads
- Pit Roads
- Collection Ponds
- Waterbodies
- Creek/River
- Wooded Areas
- Surface Water Flow Direction

REFERENCE

IAMGOLD Open Pit, May 2013.
 Base Data - MNR NRVIS, CANMAP v2008.4
 Produced by Golder Associates Ltd under licence from Ontario Ministry of Natural Resources,
 © Queens Printer 2013
 Projection: Transverse Mercator Datum: NAD 83 Coordinate System: UTM Zone 17

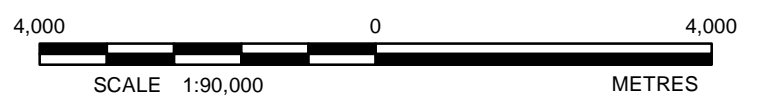

PROJECT		IAMGOLD CÔTÉ GOLD PROJECT	
TITLE		Prediction of Water Quality Effects Locations	
PROJECT No. 13-1192-0021		SCALE AS SHOWN	REV. 0
DESIGN	RRD	Feb. 2013	FIGURE: 2-5
GIS	RRD	Dec. 2013	
CHECK	NK	Jan. 2014	
REVIEW	MRG	Jan. 2014	





ATTACHMENT I

Water Quality Baseline Report, Côté Gold Project



November 10, 2014

IAMGOLD CORPORATION

Water Quality Baseline Report Côte Gold Project

Submitted to:
IAMGOLD Corporation
401 Bay Street, Suite 3200
PO Box 153
Toronto, ON M5H 2Y4

REVISED REPORT



Report Number: 13-1192-0021R

Distribution:

1 e-copy - IAMGOLD Corporation

1 copy - Golder Associates Ltd.





Table of Contents

1.0 INTRODUCTION..... 1

 1.1 Côté Gold Project Overview..... 1

2.0 SCOPE OF WORK 4

3.0 STUDY AREA..... 4

4.0 METHODS 5

 4.1 Surface Water Quality Monitoring 5

 4.1.1 Sampling Locations..... 5

 4.2 Groundwater Quality Monitoring 9

 4.3 Sample Collection Methods 12

 4.3.1 Surface Water and Groundwater Samples..... 12

 4.3.2 Water Column Profile Samples 12

 4.3.3 Laboratory Analysis..... 12

 4.3.3.1 2012-2013 Surface Water Sampling..... 12

 4.3.3.2 2013 Water Column Profile Sampling..... 13

 4.3.3.3 2012 Groundwater Sampling Program 13

 4.4 Quality Assurance/Quality Control 14

5.0 RESULTS 14

 5.1 Comparison Criteria..... 14

 5.2 Surface Water Quality..... 15

 5.2.1 Water Column Profiles 17

 5.2.1.1 Water Column Profile Field Parameter Measurements..... 17

 5.2.1.2 Water Column Profile Sample Results..... 17

 5.3 Groundwater Quality..... 19

6.0 SUMMARY OF EXISTING CONDITIONS..... 23

7.0 REFERENCES..... 24



WATER QUALITY BASELINE

TABLES

Table 1: Summary of Surface Water Quality Monitoring Program..... 5

Table 2: Summary of Groundwater Quality Monitoring Program..... 9

Table 3: Summary of Surface Water Quality Results – Watercourse Stations..... 16

Table 4: Summary of Surface Water Quality Results – Lake Profile Stations 18

FIGURES

Figure 1: Project Location 2

Figure 2: Preliminary Site Plan..... 3

Figure 3: Surface Water Quality Monitoring Locations 8

Figure 4: Groundwater Quality Monitoring Locations 11

APPENDICES

APPENDIX A

Surface Water Quality Results

APPENDIX B

Water Column Profile Plots

APPENDIX C

Groundwater Quality Results

APPENDIX D

Quality Assurance/Quality Control



1.0 INTRODUCTION

IAMGOLD Corporation (IAMGOLD) is planning to develop the Côté Gold Project (the Project) located approximately 20 kilometres (km) southwest of Gogama, Ontario, 130 km southwest of Timmins, and 200 km northwest of Sudbury (Figure 1).

This document is one of a series of physical, biological and human environment baseline reports to describe the current environmental conditions at the Project site. These baseline reports are written with the intent to support the Environmental Assessment (EA) process.

1.1 Côté Gold Project Overview

IAMGOLD is planning to construct, operate and eventually reclaim a new open pit gold mine at the Côté Gold Project site.

The proposed site layout places the required mine-related facilities in close proximity to the open pit, to the extent practicable. The proposed site layout is presented in Figure 2 showing the approximate scale of the Côté Gold Project. The site plan will be refined further as a result of ongoing consultation activities, land purchase agreements and engineering studies.

As part of the proposed development of the Project, several water features will be fully or partially overprinted. These include Côté Lake, portions of Three Duck Lakes, Clam Lake, Mollie River/Chester Lake system and Bagsverd Creek. As a consequence, these water features will need to be realigned for safe development and operation of the open pit.

The major proposed Project components are expected to include:

- open pit;
- ore processing plant;
- maintenance garage, fuel and lube facility, warehouse and administration complex;
- construction and operations accommodations complex;
- explosives manufacturing and storage facility (emulsion plant);
- various stockpiles (low-grade ore, overburden and Mine Rock Area (MRA) in close proximity to the open pit;
- aggregate extraction with crushing and screening plants;
- Tailings Management Facility (TMF);
- on-site access roads and pipelines, power infrastructure and fuel storage facilities;
- potable and process water treatment facilities;
- domestic and industrial solid waste handling facilities (landfill);
- water management facilities and drainage works, including watercourse realignments; and
- transmission line and related infrastructure.

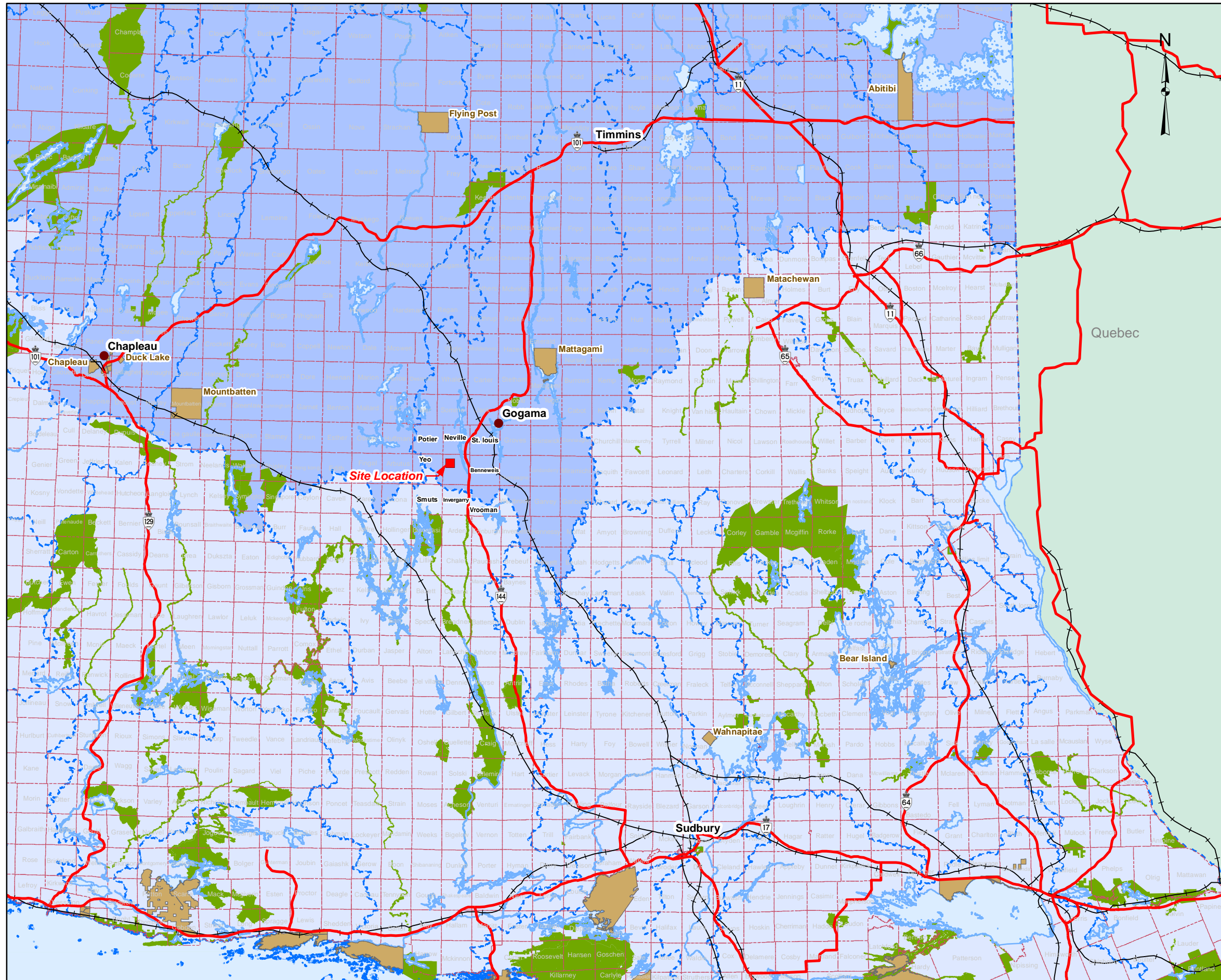

LEGEND

- Populated Places
- Major Roads
- Railway
- First Nations Communities
- Townships
- Provincial Park
- Primary Watersheds**
- Hudson Bay
- Great Lakes

REFERENCE

Base Data - MNR NRVIS, CANMAP v2008.4
 Produced by Golder Associates Ltd under licence from
 Ontario Ministry of Natural Resources, © Queens Printer 2012
 Projection: Transverse Mercator Datum: NAD 83 Coordinate System: UTM Zone 17

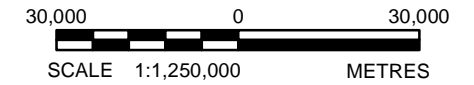

PROJECT		IAMGOLD CÔTÉ GOLD PROJECT	
TITLE		Project Location	
<p>Golder Associates Sudbury, Ontario</p>	PROJECT No. 13-1192-0021	SCALE AS SHOWN	REV. 0
	DESIGN	RRD	Dec. 2012
	GIS	RRD	Dec. 2013
	CHECK	NK	Dec. 2013
	REVIEW	MRG	Dec. 2013
			FIGURE: 1

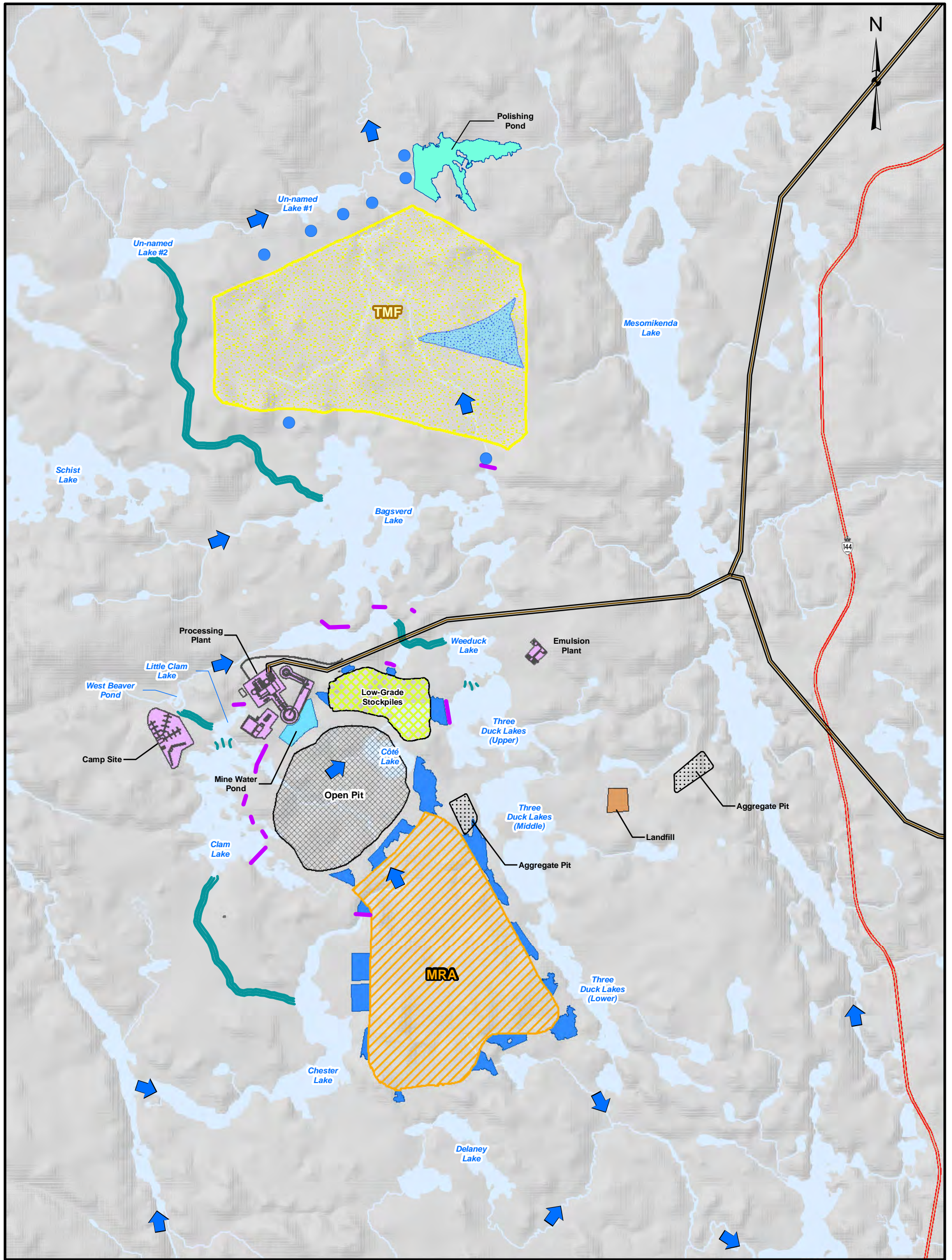

LEGEND

- Realignment Dams
- Polishing Pond
- Waterbodies
- Transmission Line
- Reclaim Pond
- Creek / River
- Watercourse Realignment
- Aggregate Pit
- Surface Water Flow Direction
- Highway 144
- Facilities
- Low-Grade Stockpiles
- Landfill
- Mine Rock Area (MRA)
- Collection Ponds
- Tailings Management Facility (TMF)
- Mine Water Pond
- Open Pit

REFERENCE

Open Pit Shell provided by IAMGOLD, May 2013
 Base Data - MNR NRVIS, CANMAP v2008.4
 Produced by Golder Associates Ltd under licence from Ontario Ministry of Natural Resources,
 © Queens Printer 2013
 Projection: Transverse Mercator Datum: NAD 83 Coordinate System: UTM Zone 17

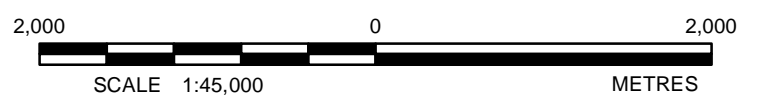

PROJECT		IAMGOLD CÔTÉ GOLD PROJECT	
TITLE			
General Site Plan			
PROJECT No. 13-1192-0021		SCALE AS SHOWN	REV. 0
DESIGN	RRD	Feb. 2013	FIGURE: 2
GIS	AL	Dec. 2013	
CHECK	NK	Dec. 2013	
REVIEW	MRG	Dec. 2013	





2.0 SCOPE OF WORK

The objective of the water quality baseline work is to establish the surface water and groundwater quality conditions within the Project site and receiving environment prior to development of the Côté Gold Project. In the context of this report, the term 'baseline' is used to describe the existing conditions at the Project site, as encountered during the time period of the water quality study.

The scope of work for the water quality baseline study is summarized as follows:

- 1) Collection of surface water and groundwater samples from monitoring station network established within the Project study area during variable climatic conditions for the purpose of water quality analysis.
- 2) Compilation of water quality data and evaluation relative to water quality criteria for comparison purposes only.
- 3) Analysis and interpretation of water quality data to characterize the baseline water quality conditions.

This report provides a factual presentation of the water quality results and highlights parameters that were observed to occur at concentrations greater than or outside of the water quality criteria. The collected baseline water quality information will be used as part of the EA process that evaluates the potential for effects that may occur due to the development of the Côté Gold Project.

3.0 STUDY AREA

The Project is located in Chester Township, southwest of the town of Gogama, Ontario, and just north of the watershed divide that separates the James Bay watershed from the Great Lakes watershed (Figure 1). Located in the Boreal Shield ecozone of Ontario (Natural Resources Canada 2012) the Project study area is characterized by long, cold winters and short, warm summers with annual water input exceeding losses to evaporation (Energy, Mines and Resources Canada 1990). The study area has experienced minor development with some forestry activities, and consists of numerous lakes and rivers that are a result of the geology and annual water surplus conditions.

The study area is characterized by shield terrain (i.e. Canadian Shield geological region), where resistant bedrock outcrops generate irregular drainage patterns, undulating topography and frequent lakes, ponds and wetlands. Bedrock ridges with sparse tree cover dominate the topographic highs with the valleys and lower elevation areas being heavily forested. Overburden thickness is highly variable with only shallow layers overlying the topographic highs and thicker overburden deposits present at the base of valleys and ridges throughout the area. Surficial geology in low-lying areas generally consists of organics (often peat) overlying fine grained morainal deposits and/or granular till and glaciofluvial deposits at depth, often with a considerable cobble and boulder component. The bedrock geology of the area generally consists of mafic metavolcanic rocks, metasedimentary rocks and pyroclastic rocks.

The study area is located within the Mattagami River watershed, which has headwaters to the south at the James Bay/Great Lakes divide and flows north for approximately 420 km to a confluence with the Moose River, which subsequently flows to James Bay. Approximately 18 dams and power generating stations are located along the Mattagami River, which also provides drinking water to the City of Timmins (110 km northeast of the Site; Figure 1). The Project site is within the Mattagami Region Source Water Protection Area, which was



developed to assist with the protection of the drinking water supply for the City of Timmins. The footprint of the Project site spreads across two subwatersheds, referred to as Mesomikenda Lake and Mollie River watersheds, which feed into the Mattagami River system.

4.0 METHODS

4.1 Surface Water Quality Monitoring

4.1.1 Sampling Locations

The surface water baseline monitoring program, initiated in September 2011, was originally established in conjunction with Trelawney Mining and Exploration Inc. (Trelawney). The original surface water baseline program was based on the 2011 proposed mine design, and therefore was initiated prior to IAMGOLD acquiring the property. In the spring of 2012, Golder and IAMGOLD revised the monitoring program with respect to sample locations and frequency. Prior to 2012, all the water quality sampling locations were paired with the hydrological monitoring locations. Since then, the existing network of stations were supplemented with additional water quality locations (not paired with hydrological stations) to better characterize the baseline water quality conditions of the study area.

Surface water sampling has been completed at numerous stations in receiving waters that are located within or adjacent to the Project site boundaries, which included quarterly or monthly sampling at the outflows of surface water features. In 2013, water quality stations were established at Dividing Lake, Delaney Lake, Mesomikenda Lake and Neville Lake, which are located downstream/downgradient of proposed mine site features and were not included in the 2012 sampling program. Additional water quality stations were established in Bagsverd Lake, Chester Lake, Clam Lake, and Three Duck Lakes, which are adjacent to the proposed open pit, MRA and low-grade stockpile. Furthermore, the 2013 additions to the surface water baseline program included water column profile stations within select lakes to evaluate the potential for lake stratification and to collect near-lakebed (“bottom”) and near-surface (“top”) samples.

Surface water quality is currently monitored by IAMGOLD at a total of 22 stations. An additional 12 water column profile locations were sampled by Golder for surface water quality beginning in May 2013. The surface water quality station locations, sampling period and monitoring frequency are described in Table 1 and shown on Figure 3. Although monthly or quarterly sampling is ongoing and will continue throughout the EA review process, the data presented herein is for the period of September 2011 through May 2013.

Table 1: Summary of Surface Water Quality Monitoring Program

Table with 7 columns: Station, Station Description, Northing (NAD83 Zone 17N), Easting (NAD83 Zone 17N), Approximate Monitoring Frequency, Water Quality Station, Water Column Profile Station. Includes sub-header 'Mesomikenda Lake Watershed' and rows for stations P-6, LCM, and P-3.



WATER QUALITY BASELINE

Station	Station Description	Northing (NAD83 Zone 17N)	Easting (NAD83 Zone 17N)	Approximate Monitoring Frequency	Water Quality Station	Water Column Profile Station
SL	bridge crossing upstream of Bagsverd Lake, downstream of Schist Lake	5269771	428496	monthly	✓	
BAG-LS1	Bagsverd Lake (upper)	5270214	429886	quarterly	✓	✓
BAG-LS2	Bagsverd Lake (lower)	5269674	430218	quarterly		✓
BPD	channel-wide rock outcrop on Bagsverd Creek upstream of BL-a subwatershed, downstream of Bagsverd Lake	5270639	431343	monthly	✓	
L-2	culvert road crossing of creek upstream of BL-b subwatershed	5273456	428297	monthly	✓	
BL-a	culvert road crossing of Bagsverd Creek upstream of BL-b subwatershed	5273627	430136	monthly	✓	
BL-b	culvert road crossing of Bagsverd Creek upstream of Neville Lake	5277424	430561	monthly	✓	
WL-1	Wolf Lake	5278209	426646	quarterly	✓	
SR	culvert road crossing of Somme River upstream of Neville Lake	5280153	429894	monthly	✓	
NL	outlet of Neville Lake	5278422	0431497	monthly	✓	
NEV-LS	Neville Lake	5277466	431443	quarterly	✓	✓
MESO-OUT	Mesomikenda Lake dam (upper basin)	5283774	435026	monthly	✓	
MESO-LS1	Mesomikenda Lake (upper basin)	5284838	433043	quarterly		✓
MESO-LS2	Mesomikenda Lake (upper basin)	5281444	433501	quarterly	✓	✓
MESO-LS3	Mesomikenda Lake (upper basin)	5277486	433694	quarterly		✓
MESO-LS4	Mesomikenda Lake (upper/middle basin)	5274044	433428	quarterly	✓	✓
MESO-LS5	Mesomikenda Lake (middle basin)	5272218	433282	quarterly	✓	✓
MESO-LS6	Mesomikenda Lake (middle basin)	5269712	433695	quarterly	✓	✓
MESO-LS7	Mesomikenda Lake (lower basin)	5267851	434288	quarterly		✓
<i>Mollie River Watershed</i>						
CHLK	culvert road crossing at Chester Lake outlet	5265373	429883	monthly	✓	
CHLK-LS	Chester Lake	5263895	429580	quarterly	✓	✓
P-2	watercourse from small beaver impoundment that merges with drainage from Chester Lake	5265587	430358	quarterly	✓	
P-1	intermittent watercourse that drains into	5265572	429420	quarterly	✓	



WATER QUALITY BASELINE

Station	Station Description	Northing (NAD83 Zone 17N)	Easting (NAD83 Zone 17N)	Approximate Monitoring Frequency	Water Quality Station	Water Column Profile Station
	Clam Lake					
P-5	ponded area between Clam Lake and Côté Lake	5265822	429599	quarterly	✓	
CM	culvert road crossing of Clam Lake	5267121	428624	monthly	✓	
CM-LS1	Clam Lake (upper basin)	5267008	428195	quarterly		✓
CM-LS2	Clam Lake (lower basin)	5266218	428286	quarterly	✓	✓
CL	culvert road crossing of Mollie River, upstream of Three Duck Lakes, downstream of Côté Lake	5267486	430164	monthly	✓	
WD	culvert road crossing at Weeduck Lake outlet, upstream of Three Duck Lakes	5268135	431442	monthly	✓	
MP	culvert road crossing upstream of northern basin of Three Duck Lakes, downstream of ore processing plant pond	5267531	431992	monthly	✓	
P-7	watercourse that drains into central basin of Three Duck Lakes	5266019	432777	quarterly	✓	
3D-LS1	Three Duck Lakes (upper basin)	5267888	431472	quarterly	✓	✓
3D-LS2	Three Duck Lakes (middle basin)	5265870	431875	quarterly	✓	✓
3D-c	narrows in south basin of Three Duck Lakes, near outlet	5263621	432866	monthly	✓	
P-4	watercourse that drains into Moille River, downstream of Three Duck Lakes outlet	5263631	432098	quarterly	✓	
DEL-LS	Delaney Lake	5262415	431333	quarterly	✓	✓
DIV-LS	Dividing Lake	5261248	435197	quarterly	✓	✓

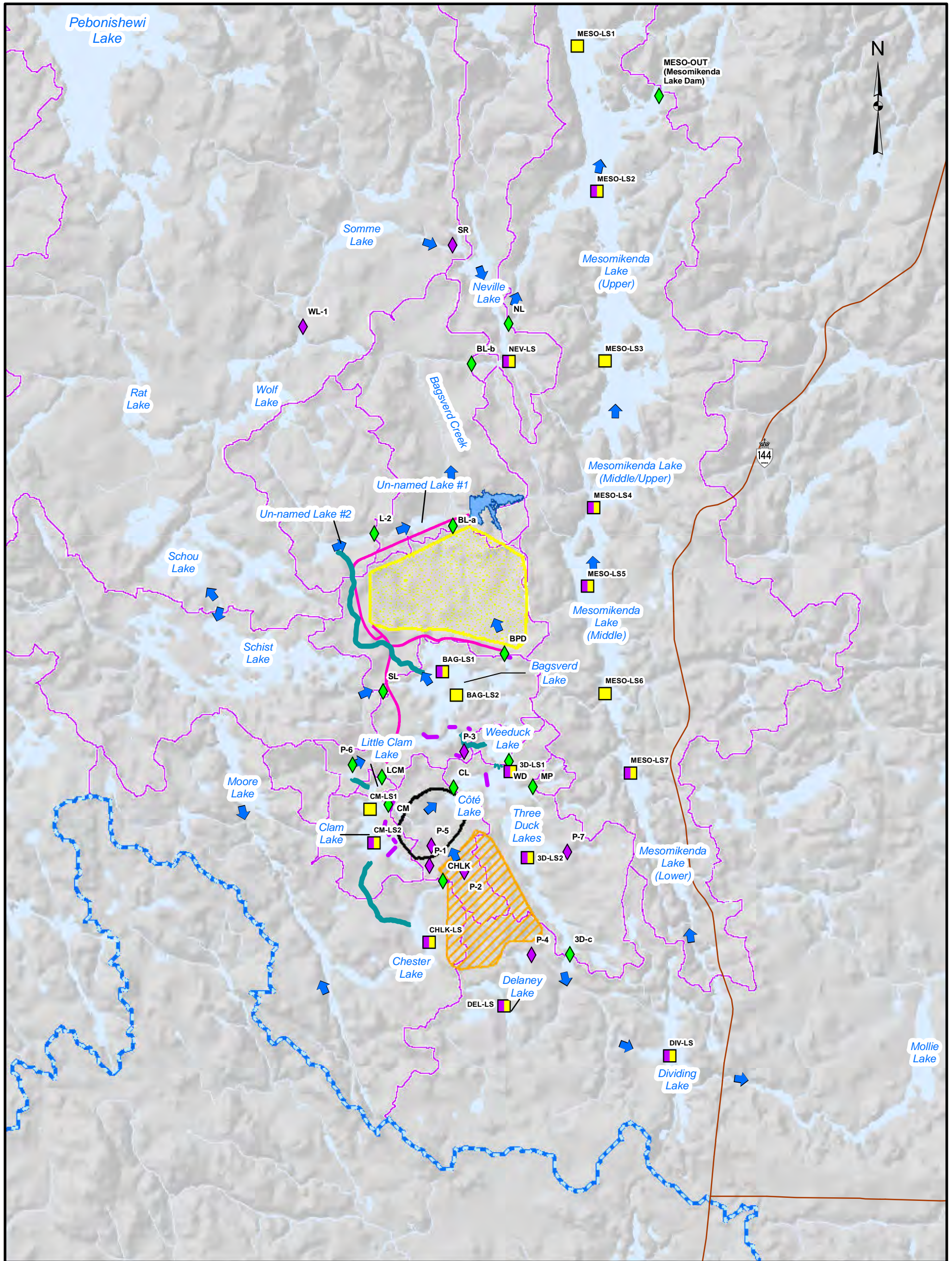

LEGEND

- Water Column Profile Location (with sample)
- Water Column Profile Location
- Watercourse Quality Monitoring Location (Monthly)
- Watercourse Quality Monitoring Location (Quarterly)
- Flow Direction
- Major Roads
- Railway
- Watercourse Realignment
- Tailings and Reclaim Pipeline
- Realignment Dams
- Polishing Pond
- Tailings Management Facility (TMF)
- Mine Rock Area (MRA)
- Open Pit
- Waterbodies
- Creek / River
- James Bay/Great Lakes Watershed Divide
- Existing Watersheds

REFERENCE

Open Pit Shell provided by IAMGOLD, May 2013
 Base Data - MNR NRVIS, CANMAP v2008.4
 Produced by Golder Associates Ltd under licence from
 Ontario Ministry of Natural Resources, © Queens Printer 2013
 Projection: Transverse Mercator Datum: NAD 83 Coordinate System: UTM Zone 17

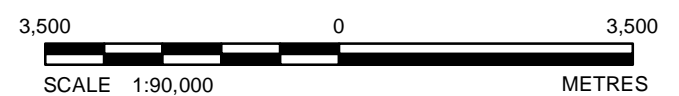

PROJECT		IAMGOLD CÔTÉ GOLD PROJECT	
TITLE		Water Quality Monitoring Sites	
PROJECT No. 13-1192-0021		SCALE AS SHOWN	REV. 0
DESIGN	RRD	Dec. 2012	FIGURE: 3
GIS	AL	Oct. 2013	
CHECK	NK	Sept. 2014	
REVIEW	MRG	Sept. 2014	





4.2 Groundwater Quality Monitoring

The groundwater quality baseline monitoring locations were originally established in early 2012; the groundwater monitoring wells were installed at locations based on the 2011 proposed mine design and in the vicinity of potential TMF and MRA alternatives. In 2012, the groundwater quality was monitored at a total of 37 locations consisting of paired or single monitoring wells. In 2013, the preferred TMF and MRA alternatives were selected, and as such, the number of wells sampled was reduced to 27 to focus on the areas adjacent to the preferred TMF and MRA. Overall, the monitoring well network was designed to cover the areas of the Project site where key conceptual mine components are expected to be located; these areas include: the open pit, TMF, and MRA (Figure 4).

The groundwater monitoring locations are described in Table 2.

Although groundwater sampling is ongoing and will continue throughout the EA review process, the data presented herein is for the period of May through December 2012. During 2012, groundwater quality was monitored during three sampling events:

- spring (May-June 2012);
- summer (August 2012); and
- fall (November-December 2012).

Table 2: Summary of Groundwater Quality Monitoring Program

Monitor	Location	Northing (NAD83 Zone 17N)	Easting (NAD83 Zone 17N)	Approximate Monitoring Frequency
BH12-1	open pit footprint	5266307	429129	thrice yearly
BH12-2A		5266558	429370	thrice yearly
BH12-2B		5266558	429370	thrice yearly
BH12-3A		5266487	429481	thrice yearly
BH12-3B		5266487	429481	thrice yearly
BH12-4		5266787	429776	thrice yearly
BH12-6		5266757	429846	thrice yearly
BH12-BULK1		5266431	429392	thrice yearly
DH12-PO-10		5266760	429113	thrice yearly
DH12-PO-14B		5266673	429707	thrice yearly
DH12-TMF-05A		TMF footprint	5273640	430191
DH12-TMF-05B	5273640		430191	thrice yearly
DH12-TMF-12	5273378		428458	thrice yearly
DH12-TMF-16	5273067		431709	thrice yearly
DH12-TMF-27A	5273409		429274	thrice yearly
DH12-TMF-27B	5273409		429274	thrice yearly
DH12-TMF-28	5271799		427955	thrice yearly
DH12-TMF-31A	5270967		429721	thrice yearly
DH12-TMF-31B	5270967		429721	thrice yearly



WATER QUALITY BASELINE

Monitor	Location	Northing (NAD83 Zone 17N)	Easting (NAD83 Zone 17N)	Approximate Monitoring Frequency
DH12-TMF-32A		5270531	431145	thrice yearly
DH12-TMF-32B		5270531	431145	thrice yearly
DH12-TMF-23A	north of TMF	5277475	429412	thrice yearly
DH12-TMF-23B		5277475	429412	thrice yearly
DH12-TMF-24A		5277385	430594	thrice yearly
DH12-TMF-24B		5277385	430594	thrice yearly
DH12-WD-01	north of open pit	5267985	430301	thrice yearly
DH12-WD-25A		5268335	429647	thrice yearly
DH12-WD-25B		5268335	429647	thrice yearly
DH12-WD-26		428599	5267746	thrice yearly
DH12-WD-12A	adjacent to MRA, south of open pit	5264679	429416	thrice yearly
DH12-WD-12B		5264679	429416	thrice yearly
DH12-WD-14		5265341	429878	thrice yearly
DH12-WD-17A		5266130	431215	thrice yearly
DH12-WD-23		5264002	432240	thrice yearly
DH12-WD-19	west of open pit and Clam Lake	5266286	427617	thrice yearly
DH12-WD-27A		5265508	428082	thrice yearly
DH12-WD-27B		5265508	428082	thrice yearly

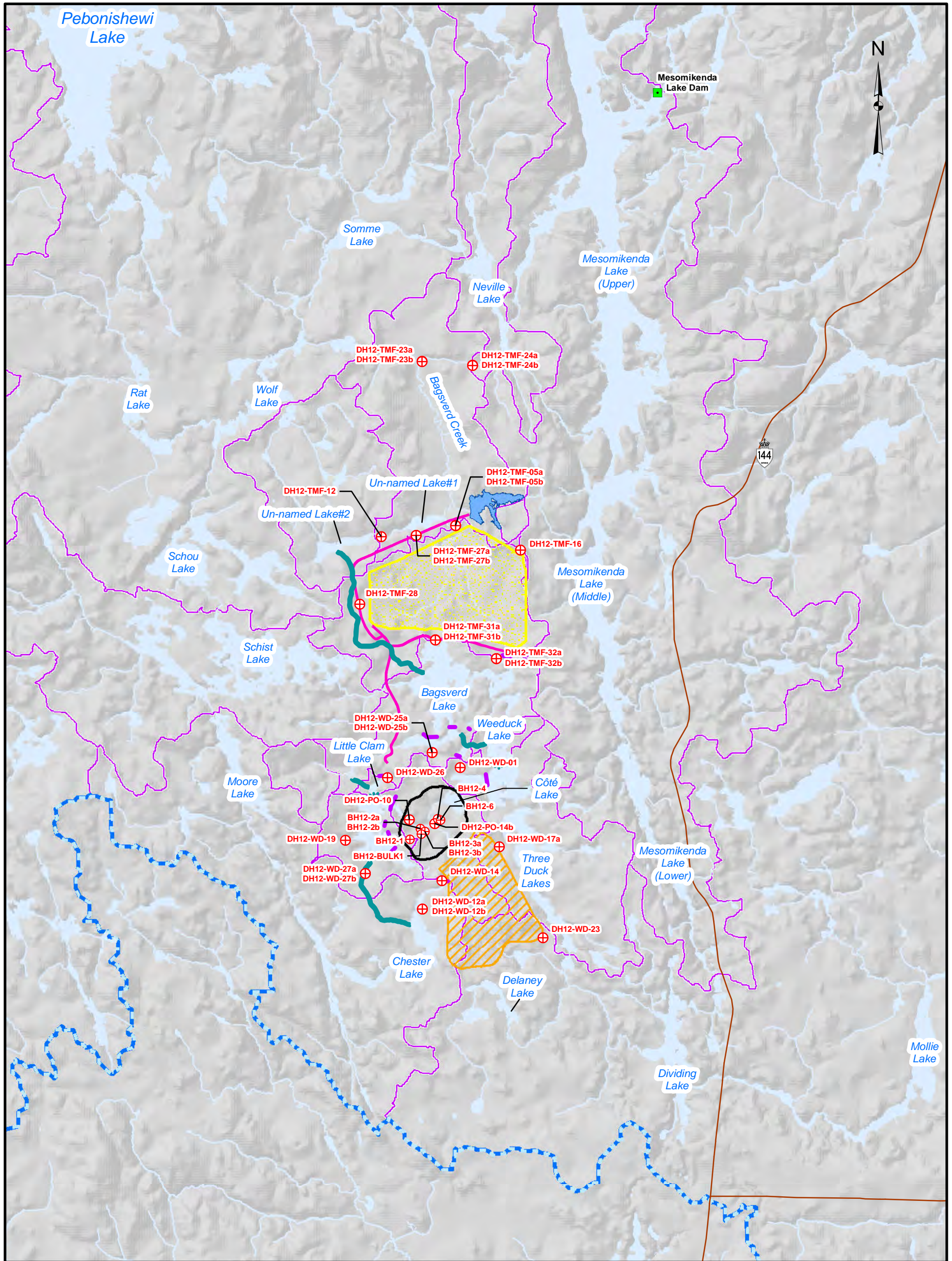

LEGEND

- ⊕ Groundwater Monitoring Well
- Dams
- Major Roads
- Railway
- Watercourse Realignment
- Tailings and Reclaim Pipeline
- Realignment Dams
- Polishing Pond
- Tailings Management Facility (TMF)
- Mine Rock Area (MRA)
- Open Pit
- Waterbodies
- Creek / River
- Arctic/Atlantic Watershed Divide
- Existing Watersheds

REFERENCE

Open Pit Shell provided by IAMGOLD, May 2013
 Base Data - MNR NRVIS, CANMAP v2008.4
 Produced by Golder Associates Ltd under licence from
 Ontario Ministry of Natural Resources, © Queens Printer 2013
 Projection: Transverse Mercator Datum: NAD 83 Coordinate System: UTM Zone 17

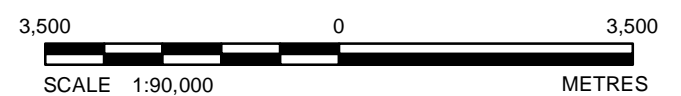

PROJECT	IAMGOLD CÔTÉ GOLD PROJECT		
TITLE	Ground Water Quality Monitoring Locations		
	PROJECT No. 13-1192-0021	SCALE AS SHOWN	REV. 0
	DESIGN RRD Dec. 2012		
	GIS AL Oct. 2013		
	CHECK NK Oct. 2013		
	REVIEW MRG Oct. 2013		
Golder Associates Sudbury, Ontario		FIGURE: 4	



4.3 Sample Collection Methods

4.3.1 Surface Water and Groundwater Samples

Surface water samples were collected as grab samples along the shores or at the outflow culverts of the water bodies. Groundwater samples were collected using dedicated Waterra tubing. Surface water and groundwater samples were placed in laboratory supplied bottles that were pre-charged with preservatives. Samples requiring filtration (dissolved aluminum, dissolved metals, dissolved organic carbon, dissolved mercury) were collected with a sterile syringe and passed through a 0.45 µm filter into individual sample bottles.

Measurements of pH, temperature, electrical conductivity and dissolved oxygen were collected in the field at the time of sampling using a YSI multiparameter meter (YSI). The YSI meter was calibrated by the supplier and, in the field, with calibration solutions provided by the supplier.

4.3.2 Water Column Profile Samples

Surface water samples at the water column profile locations were collected approximately 1 m below the surface (“top” sample) and 1 m above the lakebed (“bottom” sample) using a Kemmerer sampler, tripped by a messenger weight. Measurements of pH, oxygen-reduction potential (ORP), temperature, electrical conductivity and dissolved oxygen were collected using the YSI at regular intervals from the surface of the water column to the lakebed. The intervals of the YSI measurements were chosen depending on the total depth of the lake to produce profiles of pH, oxygen-reduction potential (ORP), temperature, electrical conductivity and dissolved oxygen. The lakes ranged in depths from approximately 2 m to 67 m; lakes shallower than 40 m were typically profiled at 1 m intervals while lakes deeper than 40 m were typically profiled at 3 m increments. The data and water quality samples were collected from an anchored boat at the deepest part of the lake basin, and the UTM coordinates of the sample location were recorded with GPS.

4.3.3 Laboratory Analysis

Samples were shipped under chain-of-custody to AGAT Laboratories Ltd. (AGAT) in Mississauga, Ontario, for chemical analysis. AGAT is accredited by the Canadian Association for Laboratory Accreditation.

4.3.3.1 2012-2013 Surface Water Sampling

Surface water quality samples were submitted for the following analyses:

- **Physical parameters:** pH, alkalinity, acidity, conductivity, total dissolved solids, total suspended solids, hardness, dissolved organic carbon, total organic carbon and chemical oxygen demand.
- **Major ions:** calcium, magnesium, potassium, sodium, chloride, fluoride, sulphate.
- **Metals:** aluminum, antimony, arsenic, barium, beryllium, boron, cadmium, chromium, cobalt, copper, iron, lead, manganese, mercury, molybdenum, nickel, selenium, silver, strontium, thallium, titanium, tungsten, uranium, vanadium, zinc and zirconium.
- **Nutrients:** nitrate, nitrite, ammonia (total), total Kjeldahl nitrogen, phosphorus (total), phosphate and soluble reactive phosphorus.



- **Organics:** oil and grease (animal/vegetable, mineral and total).
- **Radionuclides:** radium-226.
- **Other parameters:** cyanide (total) and sulphur.

The analyses were carried out with requested detection limits suitable for comparison to the Ontario Provincial Water Quality Objectives (PWQO). The analytical detection limits for some parameters exceeded the Canadian Water Quality Guidelines (CWQG); therefore, for the August 2013 sampling round, lower detection limits were requested for the following parameters in order to compare to CWQG: cadmium, copper, lead, mercury, selenium, silver and thallium.

4.3.3.2 2013 Water Column Profile Sampling

Additional parameters, including organic contaminant and microbiological parameters, were analyzed as part of the water column profile sampling program to complement the existing water quality dataset and characterize the existing conditions in the potential surface water receivers.

Surface water quality samples from the water column profile locations were submitted for the following analyses:

- **General parameters:** pH, alkalinity, acidity, electrical conductivity, dissolved oxygen, total dissolved solids, total suspended solids, total hardness, total organic carbon and dissolved organic carbon.
- **Major ions:** calcium, magnesium, potassium, sodium, sulphate, chloride, and fluoride.
- **Metals (total and dissolved):** aluminum, antimony, arsenic, barium, beryllium, boron, cadmium, chromium, cobalt, copper, iron, lead, manganese, mercury, molybdenum, nickel, selenium, silver, strontium, thallium, titanium, tungsten, uranium, vanadium, zinc and zirconium.
- **Nutrients:** nitrate, nitrite, ammonia (total) and phosphorus (total).
- **Organic contaminants (at select lakes during spring 2013 only):** oil/grease, phenols, polycyclic aromatic hydrocarbons and polychlorinated biphenyls.
- **Microorganisms:** Escherichia coli and total coliform.
- **Other parameters:** cyanide (total and free).

The analyses were carried out with requested detection limits suitable for comparison to PWQO. The analytical detection limits for some parameters exceeded the CWQG in the May 2013 sampling rounds. For the August 2013 sampling round, lower detection limits were requested for the following parameters in order to compare to CWQG: cadmium, copper, lead, mercury, selenium, silver and thallium.

4.3.3.3 2012 Groundwater Sampling Program

Groundwater quality samples were submitted for the following analyses:

- **Physical parameters:** pH, alkalinity, acidity, conductivity, total dissolved solids, total suspended solids and hardness.



- **Major ions:** calcium, magnesium, potassium, sodium, chloride, fluoride and sulphate.
- **Metals:** aluminum, antimony, arsenic, barium, beryllium, boron, cadmium, chromium, cobalt, copper, iron, lead, manganese, mercury, molybdenum, nickel, selenium, silver, strontium, thallium, titanium, tungsten, uranium, vanadium, zinc and zirconium.
- **Nutrients:** nitrate, nitrite, and ammonia (total).
- **Other parameters:** cyanide (free) and sulphur.

4.4 Quality Assurance/Quality Control

A Quality Assurance/Quality Control (QA/QC) program involving the collection of duplicate samples, field blanks and trip blanks was conducted for each sampling event. Approximately two to three duplicate samples and two blank samples were collected. The results of the QA/QC program are presented in Appendix D. These QA/QC procedures are in addition to the internal QA/QC requirements and programs of the analytical laboratory.

5.0 RESULTS

5.1 Comparison Criteria

The results of the baseline surface water and groundwater quality program are compared to the following criteria:

- PWQO (MOE 1999);
- Canadian Council of Ministers of the Environment (CCME) CWQG for the Protection of Aquatic Life (CCME 2013); and
- Ontario Ministry of the Environment (MOE) Ontario Drinking Water Standards (ODWS) (MOE 2003). The federal Guidelines for CDWQ (Health Canada 2012) were not compared as they are the same as the ODWS, with the exception of arsenic (the ODWS for arsenic is 25 µg/L while the CDWQ for arsenic is 10 µg/L).

For parameters where the criteria was dependent on pH and hardness, an assumed pH of 7 and hardness of 30 mg/L as CaCO₃ was applied.

The complete analyte list and comparison criteria for surface water and groundwater quality analysis are provided in Appendices A and B, respectively.

It should be noted that these criteria are used in this baseline report for comparison purpose only, and are not related to the impact assessment. Criteria used to assess the magnitude and significance of impact will be developed as part of the EA and provided in subsequent reports; the criteria may include those listed above for the baseline program as well as the actual baseline results.



5.2 Surface Water Quality

Surface water quality analytical results for samples collected by IAMGOLD in 2011 through 2013 are presented in Appendix A and summarized in Table 3. Total metals concentrations were compared to the water quality standards and guidelines, with the exception of aluminum that is presented as dissolved ('clay-free') concentrations. Discussion related to comparisons with the ODWS relates specifically to health-related parameters (Maximum Acceptable Concentration [MAC] or Interim Maximum Acceptable Concentration [IMAC]). Aesthetic Objectives (AO) and Operational Guidelines (OG) are not health-related standards (intended to be applied when considering water quality control practises, water treatment, disinfection and distribution) and are not applicable for the Project site or considered as part of comparisons to ODWS.

Based on the results attained to May 2013, the surface water quality can be characterized as:

- Acidic to near-neutral pH values, with approximately 10% of field pH and 22% of lab pH values not meeting the CWQG (6.5-9) and PWQO (6.5–8.5). The lowest pH (6.07) was observed at LCM in February 2013.
- Approximately 9% of dissolved aluminum concentrations were greater than the CWQG (100 µg/L), and approximately 21% were greater than the PWQO (75 µg/L). The maximum concentration (237 µg/L) was observed at P-2 in February 2013.
- Approximately 8% of copper concentrations were greater than the CWQG (2 µg/L). The maximum concentration (5 µg/L) was observed at MP in December 2012 and January 2013. It should be noted that this station is downstream of a previously existing plant to treat mine water from the dewatered Chester Mine and that surface water quality at MP may be influenced by dewatering activities.
- Approximately 13% of iron concentrations were greater than the CWQG (300 µg/L) and PWQO (300 µg/L). The maximum concentration (4,000 µg/L) was observed at P-2 in February 2013.
- Approximately 27% of total phosphorus concentrations were greater than the CWQG (20 µg/L) and PWQO (20 µg/L). The maximum concentration (90 µg/L) was observed at WD in September 2012. It should be noted that the PWQO for total phosphorus is an interim aesthetic guideline, meant to be applied as a general guideline, and should be supplemented by site-specific studies to develop site-specific criteria.
- Approximately 12% of zinc concentrations were greater than the CWQG (30 µg/L) and approximately 17% were greater than the PWQO (20 µg/L). The maximum concentration (366 µg/L) was observed at LCM in July 2012. It should be noted that there appear to be occasional anomalously high zinc concentrations in the data set, the source of which is unknown but is suspected to be related to laboratory error.
- Cadmium, lead, silver and thallium concentrations were greater than the CWQG (0.058 µg/L for cadmium, 1 µg/L for lead, 0.1 µg/L for silver and 0.8 µg/L for thallium) and/or PWQO (0.1 µg/L for cadmium, 3 µg/L for lead, 0.1 µg/L for silver and 0.3 µg/L for thallium) in only one sample. The maximum concentrations were observed at CL in April 2013.
- Concentrations of other parameters analyzed were less than the PWQOs and CWQGs, and all concentrations of parameters analyzed were less than the ODWS maximum allowable concentration (MACs) and interim maximum allowable concentration (IMACs).

The summary of results with values and percentages greater than the criteria can be found in Table 3. Full water quality results up to May 2013 are presented in Appendix A.



WATER QUALITY BASELINE

Table 3: Summary of Surface Water Quality Results – Watercourse Stations

Parameter	Criteria ⁽¹⁾		Total Number	Sample Values not Meeting Criteria				Location ⁽²⁾
	CWQG	PWQO		CWQG		PWQO		
				Number	Percent	Number	Percent	
field pH	6.5-9	6.5-8.5	215	22	10	22	10	LCM, P-3, P-6, BL-a, L-2, BL-b, NL, P-2, P-5, CL, MP, P-7, P-1, P-4
lab pH	6.5-9	6.5-8.5	241	53	22	53	22	LCM, P-3, P-6, BPD, BL-a, L-2, BL-b, SR, NL, MESO-OUT, CM, CHLK, P-2, P-5, CL, WD, MP, 3D-c, P-4
dissolved aluminum	100	75	241	23	9	50	21	P-3, P-6, BL-a, BL-b, SR, NL, MESO-OUT, P-2, P-5, MP, P-4
copper	2	5	241	19	7.9	-	-	BPD, CL, MP
iron	300	300	241	31	13	31	13	P-6, BL-a, BL-b, P-2, P-5, CL, MP, P-7, P-4
total phosphorous	20	20	241	65	27	65	27	LCM, P-6, SL, BPD, BL-a, BL-b, WL, SR, CM, P-2, P-5, CL, WD, MP, P-7
zinc	30	20	241	30	12	41	17	LCM, P-6, SL, BPD, BL-a, SR, NL, CM, P-5, CL, WD, MP, 3D-c, P-4
cadmium	0.058	0.1	241	1	0.41	1	0.41	CL
lead	1	3	241	1	0.41	-	-	CL
silver	0.1	0.1	241	1	0.41	1	0.41	CL
thallium	0.8	0.3	241	-	-	1	0.41	CL

Note:

CWQG - Canadian Water Quality Guidelines

PWQO - Provincial Water Quality Objectives

(1) For guidelines dependent on one or more of pH and hardness, an assumed pH of 7 and hardness of 30 mg/L as CaCO₃ was applied.

(2) See Table 1 or Appendix A for sampling period details.



5.2.1 Water Column Profiles

5.2.1.1 Water Column Profile Field Parameter Measurements

Field parameters were measured throughout the water column at 17 locations: Bagsverd Lake (2 locations), Neville Lake, Mesomikenda Lake (7 locations), Chester Lake, Clam Lake (2 locations), Three Duck Lakes (2 locations), Delaney Lake and Dividing Lake. The water column profile results are plotted in Appendix C.

The profile plots of temperature, dissolved oxygen, and to a less extent conductivity, at most locations showed stratification during the May 2013 and August 2013 monitoring rounds; however, the stratification during the May 2013 sampling round was less pronounced, as compared to the August 2013 data. The May 2013 profile data, therefore, suggests that turnover had occurred in the spring and the lakes were, to various degrees, in the process of transitioning from the turnover to fully stratified conditions. The August 2013 profile data shows marked decreases in temperature and dissolved oxygen with depth in the water column, reflecting fully stratified summer conditions. At some locations, conductivity increased with depth and the oxidation-reduction potential typically decreased (i.e. became more reducing) near the lake bottom. The pH was typically more acidic with depth.

5.2.1.2 Water Column Profile Sample Results

Water column profile sampling was conducted in May 2013 at 12 locations. Samples were collected from the top and bottom at each location. The summary of results and number of samples greater than the criteria can be found in Table 4. Detailed profile water quality results are presented in Appendix A.

Based on the results from the May 2013 sampling round, the surface water quality at the water column profile locations can be characterized as:

- Acidic to near-neutral pH values, with approximately 14% of field pH and 73% of lab pH values not meeting the CWQG (6.5-9) and PWQO (6.5-8). The lowest pH (6.25) was observed in the bottom sample at NEV-LS.
- Approximately 14% of dissolved aluminum concentrations were greater than the CWQG (100 µg/L), and approximately 50% were greater than the PWQO (75 µg/L). The maximum concentration (164 µg/L) was observed in the bottom sample at CM-LS.
- Approximately 9% of zinc concentrations were greater than the CWQG (30 µg/L) and approximately 14% were greater than the PWQO (20 µg/L). The maximum concentration (450 µg/L) was observed in the bottom sample at 3D-LS2. It should be noted that there appear to be occasional anomalously high zinc concentrations, the source of which is unknown but may be laboratory or sampling error.
- Cadmium concentrations were greater than the CWQG (0.058 µg/L) in only one sample. The concentration (0.1 µg/L) was observed in the top sample at CM-LS.
- Free cyanide concentrations were greater than the CWQG (5 µg/L) and PWQO (5 µg/L) in only one sample. The concentration (21 µg/L) was observed in the bottom sample at 3D-LS2.
- Concentrations of oil and grease, phenols, polycyclic aromatic hydrocarbons and polychlorinated biphenyls were below detection limits in all samples.
- Concentrations of other parameters analyzed were less than the PWQOs and CWQGs, and all concentrations of parameters analyzed were less than the ODWS MACs and IMACs.



WATER QUALITY BASELINE

Table 4: Summary of Surface Water Quality Results – Lake Profile Stations

Parameter	Criteria ⁽¹⁾		Total Number	Sample Values not Meeting Criteria				Location ⁽²⁾
	CWQG	PWQO		CWQG		PWQO		
				Number	Percent	Number	Percent	
field pH	6.5-9	6.5-8.5	22	3	14	3	14	NEV-LS, DEL-LS
lab pH	6.5-9	6.5-8.5	22	16	73	16	73	BAG-LS1, NEV-LS, MESO-LS2, MESO-LS4, MESO-LS5, MESO-LS7, CM-LS, CHLK-LS, 3D-LS1, 3D-LS2
dissolved aluminum	100	75	22	3	14	11	50	NEV-LS, MESO-LS4, CM-LS, CHLK-LS, 3D-LS1, 3D-LS2, DEL-LS
zinc	30	20	22	2	9	3	14	MESO-LS2, 3D-LS2, DEL-LS, DIV-LS
cadmium	0.058	0.1	22	1	4.5	-	-	CM-LS
free cyanide	5	5	22	1	4.5	1	4.5	3D-LS2

Note:

CWQG - Canadian Water Quality Guidelines

PWQO - Provincial Water Quality Objectives

(1) For guidelines dependent on one or more of pH and hardness, an assumed pH of 7 and hardness of 30 mg/L as CaCO₃ was applied.

(2) See Appendix A for time period details.



5.3 Groundwater Quality

Groundwater quality analytical results are presented in full in Appendix B and summarized in Table 6. As with the surface water quality results, the discussion related to comparisons between the groundwater quality results and the ODWS relates specifically to health-related parameters (MACs or IMACs). The AOs and OGs are not health-related (intended to be applied when considering water quality control practises, water treatment, disinfection and distribution) and are not applicable for the Project site or considered as part of comparisons to ODWS.

Although groundwater quality results are not directly comparable to CWQG and PWQO, as these are surface water or aquatic quality guidelines, these comparisons provide insights (at a screening level) regarding the magnitude of concentrations present in the groundwater samples and assist with the identification of parameters that may require further consideration in the context of the EA. The dissolved (filtered) metal concentrations, rather than the total concentrations, were measured in the samples of groundwater and were compared to the CWQGs and PWQOs. The dissolved concentrations of metals are more relevant to groundwater because the total concentrations include the proportion of metals present within suspended solids, which do not travel through most subsurface environments.

In general, the groundwater quality up to December 2012 can be characterized as:

- Acidic to near-neutral pH values, with approximately 22% of field pH values not meeting the CWQG (6.5-9) and PWQO (6.5-8.5). The lowest pH (5.5) was observed at DH12-WD-01 and the highest pH (8.86) was observed at BH12-2B.
- Approximately 16% of aluminum concentrations were greater than the CWQG (100 µg/L) and 18% were greater than the PWQO (75 µg/L). The maximum concentration (209 µg/L) was observed at DH12-WD-25B.
- Approximately 1% of arsenic concentrations were greater than the ODWS (25 µg/L) and 6.6% were greater than the CWQG (5 µg/L) and PWQO (5 µg/L). The maximum concentration (179 µg/L) was observed at DH12-TMF-32A.
- Approximately 9% of cadmium concentrations were greater than the CWQG (0.058 µg/L) and 2.8% were greater than the PWQO (0.1 µg/L). The maximum concentration (0.2 µg/L) was observed at DH12-TMF-32B and DH12-WD-01.
- Approximately 2.8% of chromium concentrations were greater than the CWQG (8.9 µg/L) and the PWQO (8.9 µg/L). The maximum concentration (9 µg/L) was observed at DH12-TMF-12.
- Approximately 5.6% of cobalt concentrations were greater than the PWQO (0.9 µg/L). The maximum concentration (3.9 µg/L) was observed at DH12-TMF-05B.
- Approximately 23% of copper concentrations were greater than the CWQG (2 µg/L) and 8.5% were higher than the PWQO (5 µg/L). The highest concentration (16 µg/L) was observed at BH12-4.
- Approximately 22% of iron concentrations were greater than the CWQG (300 µg/L) and PWQO (300 µg/L). The highest concentration (13,800 µg/L) was observed at DH12-TMF-05B.



WATER QUALITY BASELINE

- Approximately 4.7% of molybdenum concentrations were greater than the CWQG (73 µg/L) and 8.5% were greater than the PWQO (40 µg/L). The highest concentration (179 µg/L) was observed at DH12-TMF-05A.
- Approximately 3.8% of silver concentrations were greater than the CWQG (0.1 µg/L) and PWQO (0.1 µg/L). The highest concentration (0.2 µg/L) was observed at DH12-TMF-16, DH12-TMF-27A and DH12-TMF-31A.
- Approximately 21% of tungsten concentrations were greater than the PWQO (30 µg/L). The highest concentration (677 µg/L) was observed at DH12-WD-17A.
- Approximately 1% of uranium concentrations were greater than the ODWS (20 µg/L), 1.9% were greater than the CWQG (15 µg/L) and 9.4% were greater than the PWQO (5 µg/L). The highest concentration (21 µg/L) was observed at DH12-TMF-23A.
- Approximately 1.9% of vanadium concentrations were greater than the PWQO (6 µg/L). The highest concentration (18 µg/L) was observed at DH12-TMF-24B.
- Approximately 30% of zinc concentrations were greater than the CWQG (30 µg/L) and 37% were higher than the PWQO (20 µg/L). The highest concentration (1,250 µg/L) was observed at DH12-TMF-05B. It should be noted that there appear to be occasional anomalously high zinc concentrations in the data set, the source of which is unknown but is suspected to be laboratory error.
- Un-ionized ammonia concentrations were greater than the CWQG (19 µg/L) and PWQO (20 µg/L) in only one sample. The maximum concentration (30 µg/L) was observed at BH12-2B.
- Approximately 2.8% of free cyanide concentrations were greater than the CWQG (5 µg/L) and PWQO (5 µg/L). The highest concentration (7 µg/L) was observed at DH12-TMF-32B.
- Concentrations of other parameters analyzed were less than the ODWS MACs/IMACs, PWQOs and CWQGs.



WATER QUALITY BASELINE

Table 5: Summary of Groundwater Quality Results

Parameter	Criteria ⁽¹⁾			Total Number	Sample Values not Meeting Criteria						Locations
	ODWS	CWQG	PWQO		ODWS		CWQG		PWQO		
					Number	Percent	Number	Percent	Number	Percent	
field pH	-	6.5-9	6.5-8.5	105	-	-	23	22	23	22	BH12-1, BH12-2A, BH12-2B, BH12-3A, BH12-4, DH12-PO-10, DH12-TMF-12, DH12-TMF-28, DH12-TMF-24A, DH12-TMF-24B, DH12-WD-01, DH12-WD-12A, DH12-WD-17A, DH12-WD-23, DH12-WD-01, DH12-WD-25A, DH12-WD-25B
total suspended solids	-	25000	-	106	-	-	106	100	-	-	BH12-1, BH12-2A, BH12-2B, BH12-3A, BH12-3B, BH12-4, BH-12-6, BH12-BULK1, DH12-PO-10, DH12-PO-14B, DH12-TMF-05A, DH12-TMF-05B, DH12-TMF-12, DH12-TMF-16, DH12-TMF-27A, DH12-TMF-27A, DH12-TMF-28, DH12-TMF-31A, DH12-TMF-31B, DH12-TMF-32A, DH12-TMF-32B, DH12-TMF-23A, DH12-TMF-23B, DH12-TMF-24A, DH12-TMF-24B, DH12-WD-01, DH12-WD-12A, DH12-WD-12B, DH12-WD-14, DH12-WD-17A, DH12-WD-19, DH12-WD-23, DH12-WD-01, DH12-WD-25A, DH12-WD-25B, DH12-WD-26, DH12-WD-27A, DH12-WD-27B
aluminum	-	100	75	106	-	-	17	16	19	18	BH12-3B, DH12-PO-10, DH12-PO-14B, DH12-TMF-05A, DH12-TMF-05B, DH12-TMF-16, DH12-TMF-32B, DH12-TMF-24A, DH12-TMF-24B, DH12-WD-01, DH12-WD-01, DH12-WD-25B, DH12-WD-27B
arsenic	25	5	5	106	1	0.9	7	6.6	7	6.6	DH12-PO-10, DH12-TMF-32A, DH12-WD-25A, DH12-WD-25B
cadmium	5	0.058	0.1	106	-	-	10	9.4	3	2.8	BH12-BULK1, DH12-TMF-27A, DH12-TMF-32A, DH12-TMF-32B, DH12-WD-01, DH12-WD-14, DH12-WD-17A, DH12-WD-01, DH12-WD-27A
chromium	50	8.9	8.9	106	-	-	3	2.8	3	2.8	DH12-TMF-05B
cobalt	-	-	0.9	106	-	-	-	-	6	5.6	DH12-TMF-05B, DH12-WD-01, DH12-WD-01
copper	-	2	5	106	-	-	25	23	9	8.5	BH12-1, BH12-3A, BH12-3B, BH12-4, BH-12-6, BH12-BULK1, DH12-PO-10, DH12-TMF-16, DH12-TMF-27A, DH12-TMF-32B, DH12-WD-01, DH12-WD-17A, DH12-



WATER QUALITY BASELINE

Parameter	Criteria ⁽¹⁾			Total Number	Sample Values not Meeting Criteria						Locations
	ODWS	CWQG	PWQO		ODWS		CWQG		PWQO		
					Number	Percent	Number	Percent	Number	Percent	
											WD-01, DH12-WD-27B
iron	-	300	300	106	-	-	23	22	23	22	DH12-TMF-05B, DH12-TMF-24A, DH12-TMF-24B, DH12-WD-01, DH12-WD-23, DH12-WD-01, DH12-WD-25A, DH12-WD-25B, DH12-WD-26
molybdenum	-	73	40	106	-	-	5	4.7	9	8.5	BH12-3A, BH12-BULK1, DH12-PO-10, DH12-TMF-05A
silver	-	0.1	0.1	106	-	-	4	3.8	4	3.8	DH12-TMF-16, DH12-TMF-27A, DH12-TMF-31A
tungsten	-	-	30	106	-	-	-	-	22	21	BH-12-1, BH12-3A, BH12-4, BH12-6, DH12-PO-10, DH12-PO-14B, DH12-TMF-16, DH12-TMF-27A, DH12-TMF-32A, DH12-WD-01, DH12-WD-12B, DH12-WD-14, DH12-WD-17A, DH12-WD-01
uranium	20	15	5	106	1	0.9	2	1.9	10	9.4	BH12-3A, BH12-4, BH12-BULK1, DH12-TMF-05A, DH12-TMF-23A
vanadium	-	-	6	106	-	-	-	-	2	1.9	DH12-TMF-24B
zinc	-	30	20	106	-	-	32	30	39	37	BH12-1, BH12-2B, BH12-3B, BH12-4, DH12-PO-10, DH12-PO-14B, DH12-TMF-05A, DH12-TMF-05B, DH12-TMF-16, DH12-TMF-27A, DH12-TMF-28, DH12-TMF-31A, DH12-TMF-32B, DH12-TMF-23A, DH12-TMF-23B, DH12-TMF-24A, DH12-TMF-24B, DH12-WD-01, DH12-WD-12A, DH12-WD-12B, DH12-WD-14, DH12-WD-17A, DH12-WD-23, DH12-WD-01, DH12-WD-25B, DH12-WD-26, DH12-WD-27A, DH12-WD-27B
un-ionized ammonia	-	19	20	101	-	-	1	1	1	1	BH12-2B
free cyanide	200	5	5	106	-	-	3	2.8	3	2.8	DH12-TMF-32B, DH12-WD-01, DH12-WD-01



6.0 SUMMARY OF EXISTING CONDITIONS

A water quality baseline study was completed as part of the Côté Gold Project EA to establish the surface water and groundwater quality conditions within the Project site and receiving environment prior to Project development. Surface water quality sampling has been completed at 34 locations, including 12 lake profile locations. Groundwater quality sampling has been completed at 37 locations within the vicinity of the proposed open pit, TMF, and MRAs. Samples collected for the water quality baseline study were analyzed for a variety of parameters, including: general or physiochemical parameters, major ions, metals, nutrients, organics (oil and grease, polycyclic aromatic hydrocarbons, polychlorinated biphenyls), radionuclides and microorganisms.

The surface water quality at the stations monitored can be generally characterized as having acidic to near-neutral pH, with occasional concentrations above the CWQG and PWQO for the following parameters: aluminum, copper, iron, phosphorus (total), zinc, cadmium, lead, silver, thallium and cyanide (free). Surface water concentrations of other parameters analyzed were less than the PWQOs and CWQGs, and all concentrations of parameters analyzed were less than the ODWS MACs and IMACs. The occasional surface water concentrations that were observed to be greater than aquatic guidelines, and the general surface water quality observed in the study area, are typical of lakes and watercourses that are present within shield terrain (i.e., Canadian Shield geological region). Generally, within these types of hydrological settings, flow is strongly controlled by bedrock outcrops that generate irregular drainage patterns and the occasional concentrations greater than aquatic guidelines likely reflects the influence on surface water quality by natural bedrock weathering processes.

The groundwater quality can be generally characterized as having acidic to near-neutral pH, with occasional concentrations above the CWQG and PWQO for the following parameters: aluminum, arsenic, cadmium, chromium, cobalt, copper, iron, molybdenum, silver, tungsten, uranium, vanadium, zinc, un-ionized ammonia and free cyanide. The following parameter concentrations were occasionally above the OWDS MAC: arsenic and uranium. Concentrations of other parameters analyzed were less than the ODWS MACs/IMACs, PWQOs and CWQGs. For some metals, the concentrations in the groundwater were greater than those observed for surface water; this is expected as groundwater experiences a greater degree of water-rock interaction, as compared to surface water, and therefore is more influenced by natural weathering processes in the subsurface. The occasional groundwater concentrations that were observed to be greater than aquatic and drinking water guidelines is not uncommon for shield regions, in particular those with known gold mineralization.

The water column profiling was completed in May and August of 2013 to evaluate the potential for thermal and chemical stratification within key lakes across the study area. The profiles of dissolved oxygen, temperature, and to a lesser extent conductivity, indicate that the water column is stratified during mid- to late-spring and throughout the summer months. Comparisons between the profiles collected in May 2013 versus those collected in August show that the stratified conditions were less predominate during May 2013; this suggests that some of the lakes experienced turnover during the spring of 2013 and were in the process of transitioning to the fully stratified conditions that were observed during the summer.



7.0 REFERENCES

- Canadian Council of Ministers of the Environment. 2013. Canadian Water Quality Guidelines for the Protection of Aquatic Life Update 7.1 (December 2007). Available online at: http://www.ccme.ca/publications/ceqg_rcqe.html, accessed July, 2013.
- Emerson, K., R.C. Russo, R.E. Lund and R.V. Thurston. 1975. Aqueous ammonia equilibrium calculations: Effect of pH and temperature. *J. Fish Res. Board Can.* 32: 2379-2383.
- Energy, Mines and Resources Canada. 1990. National Atlas of Canada 5th Edition, Canada Climatic Regions Thornthwaite Classification, Moisture Regions, Map MCR4096 and Thermal Efficiency Regions MCR 4155F.
- Health Canada. 2012. Guidelines for Canadian Drinking Water Quality – Summary Table. Water, Air and Climate Change Bureau, Healthy Environments and Consumer Safety Branch, Health Canada, Ottawa, Ontario.
- Natural Resources Canada. 2012. The Atlas of Canada. Available online at <http://atlas.nrcan.gc.ca/auth/english/index.html>. Accessed November 2012.
- Ontario Ministry of Environment and Energy. 1999. Provincial Water Quality Objectives, PIBS 3303E, Queen's Printer for Ontario. July 1994, reprinted February 1999.
- Ontario Ministry of the Environment. 2003. Technical Support Document for Ontario Drinking Water Standards Objectives and Guidelines.
- Roed, M.A. and Hallett, D.R. 1979. Northern Ontario Engineering Geology Terrain Study. Data Base Map, Gogama. Ontario Geological Survey, Map 5019, Scale 1:100,000.



Report Signature Page

GOLDER ASSOCIATES LTD.

Natalie Korczak, M.Sc., P.Ge.
Geochemist

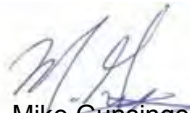
Mike Gunsinger, M.Sc., P.Ge.
Associate/Hydrogeochemist

NK/MRG/ls

Golder, Golder Associates and the GA globe design are trademarks of Golder Associates Corporation.

n:\active\2013\1190 sudbury\1192\13-1192-0021 iamgold cote gold project timmins\3. water quality\reporting\baseline report\13-1192-0021r rpt 14nov10 revised iamgold wq baseline.docx



APPENDIX A

Surface Water Quality Results

APPENDIX A
2011-2013 Surface Water Quality Results

Parameter ⁽¹⁾	Unit	Method Detection Limit	Ontario Drinking Water Standards ⁽²⁾⁽³⁾		Canadian Water Quality Guidelines ⁽⁴⁾	Provincial Water Quality Objective ⁽⁵⁾	LCM - Little Clam Lake Outlet											
			MAC	IMAC			21-Feb-12	30-Apr-12	31-May-12	27-Jun-12	18-Jul-12	20-Aug-12	24-Sep-12	23-Oct-12	19-Nov-12	29-Jan-13	24-Feb-13	19-Mar-13
FIELD PARAMETERS																		
pH	pH units	--	--	--	6.5-9	6.5-8.5	7.45	--	6.76	7.29	7.58	7.43	6.6	6.94	6.94	6.8	6.07	6.51
Temperature	degrees Celsius	--	--	--	--	-0.25	0.1	--	10	21.7	21.3	19.4	11.6	5.1	1.4	0	-0.3	-0.3
Conductivity	µS/cm	--	--	--	--	--	20.2	--	30.1	33.2	34	32.2	26.7	21.3	19.1	22.7	22	21.2
Dissolved Oxygen (DO)	µg/L	--	--	--	--	--	6600	--	4500	7660	6850	7430	8270	10450	1295	13020	2600	2770
GENERAL PARAMETERS																		
pH	pH units	--	--	--	6.5-9	6.5-8.5	6.81	6.56	6.46	6.96	6.5	6.63	6.74	6.48	6.39	6.22	6.13	6.19
Alkalinity	µg/L as CaCO ₃	<5000	--	--	--	-25%	12000	10000	13000	10000	10000	10000	10000	13000	9000	11000	12000	13000
Acidity	µg/L as CaCO ₃	<5000	--	--	--	--	--	--	--	--	--	--	--	--	--	--	--	--
Electrical Conductivity (EC)	µS/cm	<2	--	--	--	--	39	34	39	35	35	36	36	35	37	43	42	44
Total Dissolved Solids (TDS)	µg/L	<20000	--	--	--	--	46000	30000	60000	28000	32000	42000	40000	46000	46000	34000	36000	26000
Total Suspended Solids (TSS)	µg/L	<1000, <10000	--	--	+5000-25000 ⁽⁶⁾	--	<10000	<10000	<10000	<10000	<10000	<10000	<10000	2000	6000	<1000	<1000	<1000
Total Hardness	µg/L as CaCO ₃	<500	--	--	--	--	18400	16100	17600	14100	15900	17600	15700	15900	17600	19700	19700	19100
Dissolved Organic Carbon (DOC)	µg/L	<500	--	--	--	--	13300	8100	8200	12000	9700	7500	10600	9500	12900	10700	10200	10500
Total Organic Carbon (TOC)	µg/L	<500	--	--	--	--	--	--	--	--	--	--	--	--	--	--	--	--
Chemical Oxygen Demand (COD)	µg/L	<5000	--	--	--	--	--	--	--	--	--	--	--	--	--	--	--	--
MAJOR IONS																		
Calcium (Ca)	µg/L	<50	--	--	--	--	6210	5360	5930	4700	5330	5390	5830	5210	5330	5810	6500	6270
Magnesium (Mg)	µg/L	<50	--	--	--	--	710	650	690	580	640	700	750	650	630	740	840	840
Potassium (K)	µg/L	<50	--	--	--	--	280	260	160	250	330	290	380	290	550	250	280	320
Sodium (Na)	µg/L	<50	--	--	--	--	720	670	680	630	700	690	730	680	830	750	850	800
Chloride (Cl)	µg/L	<100	--	--	--	--	320	270	250	270	260	280	340	310	410	370	430	350
Fluoride (F)	µg/L	<50	1500 ⁽⁷⁾	--	--	--	<50	<50	<50	<50	<50	<50	100	<50	<50	<50	<50	<50
Sulphate (SO ₄)	µg/L	<100	--	--	--	--	2810	3290	2440	2920	2970	3250	3060	3300	3490	4100	3510	3230
METALS																		
Aluminum (Al)	µg/L	<4	--	--	100 ⁽⁸⁾	75 ⁽⁹⁾	40	60	55	31	23	18	16	26	32	49	45	43
Antimony (Sb)	µg/L	<6	--	6	--	20	<6	<6	<6	<6	<6	<6	<6	<6	<6	<6	<6	<6
Arsenic (As)	µg/L	<3	--	25	5	5	<3	<3	<3	<3	<3	<3	<3	<3	<3	<3	<3	<3
Barium (Ba)	µg/L	<2	1000	--	--	--	5	4	4	4	8	4	5	4	4	5	3	4
Beryllium (Be)	µg/L	<1	--	--	--	11 ⁽¹⁰⁾	<1	<1	<1	<1	<1	<1	<1	<1	<1	<1	<1	<1
Boron (B)	µg/L	<10	--	5000	1500 ⁽¹¹⁾	200	<10	<10	<10	<10	<10	<10	<10	<10	<10	<10	<10	<10
Cadmium (Cd)	µg/L	<0.1	--	5	0.058 ⁽¹²⁾	0.1 ⁽¹³⁾	<0.1	<0.1	<0.1	<0.1	<0.1	<0.1	<0.1	<0.1	<0.1	<0.1	<0.1	<0.1
Chromium (Cr)	µg/L	<3	50	--	8.9 ⁽¹⁴⁾	8.9 ⁽¹⁴⁾	<3	<3	<3	<3	<3	<3	<3	<3	<3	<3	<3	<3
Cobalt (Co)	µg/L	<0.5	--	--	--	0.9	<0.5	<0.5	<0.5	<0.5	<0.5	<0.5	<0.5	<0.5	<0.5	<0.5	<0.5	<0.5
Copper (Cu)	µg/L	<2	--	--	2 ⁽¹⁵⁾	5 ⁽¹⁶⁾	<2	<2	<2	<2	<2	<2	<2	<2	<2	<2	<2	<2
Iron (Fe)	µg/L	<10	--	--	300	300	31	70	135	52	87	34	20	43	40	37	99	84
Lead (Pb)	µg/L	<1	10 ⁽¹⁷⁾	--	1 ⁽¹⁸⁾	3 ⁽¹⁹⁾	<1	<1	<1	<1	<1	<1	<1	<1	<1	<1	<1	<1
Manganese (Mn)	µg/L	<2	--	--	--	--	8	8	69	7	31	11	11	6	10	6	24	31
Mercury (Hg)	µg/L	<0.10	1	--	0.026	0.2	<0.10	<0.10	<0.10	<0.10	<0.10	<0.10	<0.10	<0.10	<0.10	<0.10	<0.10	<0.10
Molybdenum (Mo)	µg/L	<2	--	--	73	40	<2	<2	<2	<2	<2	<2	<2	<2	<2	<2	<2	<2
Nickel (Ni)	µg/L	<3	--	--	25 ⁽²⁰⁾	25	<3	<3	<3	<3	<3	<3	<3	<3	<3	<3	<3	<3
Selenium (Se)	µg/L	<4	10	--	1	100	<4	<4	<4	<4	<4	<4	<4	<4	<4	<4	<4	<4
Silver (Ag)	µg/L	<0.1	--	--	0.1	0.1	<0.1	<0.1	<0.1	<0.1	<0.1	<0.1	<0.1	<0.1	<0.1	<0.1	<0.1	<0.1
Strontium (Sr)	µg/L	<5	--	--	--	--	13	14	13	12	30	13	15	12	11	16	12	14
Thallium (Tl)	µg/L	<0.3	--	--	0.8	0.3	<0.3	<0.3	<0.3	<0.3	<0.3	<0.3	<0.3	<0.3	<0.3	<0.3	<0.3	<0.3
Titanium (Ti)	µg/L	<2	--	--	--	--	<2	<2	<2	<2	<2	<2	<2	<2	<2	<2	<2	<2
Tungsten (W)	µg/L	<10	--	--	--	30	<10	<10	<10	<10	<10	<10	<10	<10	<10	<10	<10	<10
Uranium (U)	µg/L	<2	20	--	15	5	<2	<2	<2	<2	<2	<2	<2	<2	<2	<2	<2	<2
Vanadium (V)	µg/L	<2	--	--	--	6	<2	<2	<2	<2	<2	<2	<2	<2	<2	<2	<2	<2
Zinc (Zn)	µg/L	<5	--	--	30	20	5	14	<5	<5	366	<5	9	<5	6	10	<5	11
Zirconium (Zr)	µg/L	<4	--	--	--	4	<4	<4	<4	<4	<4	<4	<4	<4	<4	<4	<4	<4
OTHER PARAMETERS																		
Total Cyanide	µg/L	<2	--	--	--	--	<2	<2	<2	<2	53	<2	<2	<2	<2	<2	<2	<2
Sulphur (S)	µg/L	<50	--	--	--	--	--	--	--	--	--	--	--	--	--	--	--	--
NUTRIENTS																		
Nitrate (NO ₃ ⁻)	µg/L as N	<50	10000	--	13000 ⁽²¹⁾	--	--	--	--	--	--	--	--	--	--	--	--	--
Nitrite (NO ₂ ⁻)	µg/L as N	<50	1000	--	60 ⁽²²⁾	--	--	--	--	--	--	--	--	--	--	--	--	--
Total Ammonia (NH ₃ + NH ₄)	µg/L as N	<20	--	--	6980	--	<20	<20	<20	<20	<20	<20	30	<20	<20	50	<20	<20
Un-ionized Ammonia (NH ₃)	µg/L	--	--	--	19 ⁽²³⁾	20 ⁽²³⁾	<0.052	--	<0.038	<0.28	<0.26	<0.24	0.0207	<0.026	<0.018	0.0415	<0.00166	<0.0052
Total Kjeldahl Nitrogen	µg/L	<100	--	--	--	--	--	--	--	--	--	--	--	--	--	--	--	--
Total Phosphorus (P)	µg/L	<20	--	--	20	20	<20	<20	<20	50	50	40	20	<20	30	<20	<20	<20
Phosphate (PO ₄)	µg/L as P	<100	--	--	--	--	--	--	--	--	--	--	--	--	--	--	--	--
Soluble Reactive Phosphorus	µg/L	<20	--	--	--	--	--	--	--	--	--	--	--	--	--	--	--	--
ORGANICS																		
Oil and Grease (Animal/Vegetable)	µg/L	<500	--	--	--	--	--	--	--	--	--	--	--	--	--	--	--	--
Oil and Grease (Mineral)	µg/L	<500	--	--	--	--	--	--	--	--	--	--	--	--	--	--	--	--
Oil and Grease (Total)	µg/L	<500	--	--	--	physically non detect	--	--	--	--	--	--	--	--	--	--	--	--
RADIONUCLIDES																		
Radium-226	Bq/L	<0.001	0.6	--	--	1 ⁽²⁴⁾	--	--	--	--	--	--	--	--	<0.001	<0.001	<0.001	<0.001

APPENDIX A
2011-2013 Surface Water Quality Results

Parameter ⁽¹⁾	Unit	Method Detection Limit	Ontario Drinking Water Standards ⁽²⁾⁽³⁾		Canadian Water Quality Guidelines ⁽⁴⁾	Provincial Water Quality Objective ⁽⁵⁾	P-3 - Inflow to Bagsverd Lake					P-6 - Inflow to Bagsverd Lake										
			MAC	IMAC			19-Nov-12	24-Feb-13	26-Mar-12	30-Apr-12	31-May-12	28-Jun-12	18-Jul-12	20-Aug-12	24-Sep-12	23-Oct-12	19-Nov-12	17-Dec-12	29-Jan-13	24-Feb-13	19-Mar-13	24-Apr-13
FIELD PARAMETERS																						
pH	pH units	--	--	--	6.5-9	6.5-8.5	<u>6.32</u>	<u>6.43</u>	6.6	7.63	7.07	6.51	7.12	7.12	7	7.21	6.85	7	6.6	6.94	6.98	<u>6.34</u>
Temperature	degrees Celsius	--	--	--	--	-0.25	2.7	0.9	3.7	8	16.2	20.6	19.7	16.3	10.8	2.5	4.8	0.4	0.3	-0.1	-0.2	0.4
Conductivity	µS/cm	--	--	--	--	--	23	27.3	23	30	53.6	86.2	73.6	67.3	45.2	31.6	35.8	33.5	55	58.2	51.9	22.8
Dissolved Oxygen (DO)	µg/L	--	--	--	--	--	907	5300	7000	1810	5050	1050	4480	3240	9330	11390	1031	870	2800	2310	2920	1152
GENERAL PARAMETERS																						
pH	pH units	--	--	--	6.5-9	6.5-8.5	<u>6.31</u>	<u>6.2</u>	6.76	6.63	6.89	7.4	6.81	7.05	7.14	6.73	6.91	6.64	6.54	6.53	6.67	<u>6.43</u>
Alkalinity	µg/L as CaCO3	<5000	--	--	--	-25%	7000	11000	12000	15000	29000	38000	36000	36000	26000	21000	19000	24000	41000	43000	41000	10000
Acidity	µg/L as CaCO3	<5000	--	--	--	--	--	--	--	--	--	--	--	--	--	--	--	--	--	--	--	--
Electrical Conductivity (EC)	µS/cm	<2	--	--	--	--	37	45	42	47	65	80	78	80	61	54	54	62	100	100	98	39
Total Dissolved Solids (TDS)	µg/L	<20000	--	--	--	--	72000	60000	32000	40000	94000	60000	62000	80000	58000	58000	66000	70000	120000	56000	68000	54000
Total Suspended Solids (TSS)	µg/L	<1000, <10000	--	--	+5000-25000 ⁽⁶⁾	--	<1000	3000	<10000	<10000	<10000	<10000	20000	<10000	<1000	<1000	<1000	<1000	2000	2000	2000	1000
Total Hardness	µg/L as CaCO3	<500	--	--	--	--	19200	20400	20100	22400	31700	36900	40400		34000	27000	27100	33000	43300	45200	41300	20400
Dissolved Organic Carbon (DOC)	µg/L	<500	--	--	--	--	14600	17900	13000	10900	12500	--	13000	9000	11400	11400	10700	12400	13200	11900	8600	15300
Total Organic Carbon (TOC)	µg/L	<500	--	--	--	--	--	--	--	--	--	--	--	--	--	--	--	--	--	--	--	--
Chemical Oxygen Demand (COD)	µg/L	<5000	--	--	--	--	--	--	--	--	--	--	--	--	--	--	--	--	--	--	--	--
MAJOR IONS																						
Calcium (Ca)	µg/L	<50	--	--	--	--	6360	6760	5950	6790	9500	--	12300	12400	10300	8170	8150	9960	13400	14100	12500	6030
Magnesium (Mg)	µg/L	<50	--	--	--	--	810	850	1270	1330	1940	--	2360	2460	2010	1600	1650	1970	2400	2420	2460	1290
Potassium (K)	µg/L	<50	--	--	--	--	320	430	260	160	140	--	200	120	130	150	310	210	360	360	350	410
Sodium (Na)	µg/L	<50	--	--	--	--	1040	880	790	930	1330	--	880	2460	970	990	1170	1090	1190	1150	1110	780
Chloride (Cl)	µg/L	<100	--	--	--	--	400	340	230	320	240	--	330	390	400	340	460	520	640	640	560	300
Fluoride (F)	µg/L	<50	1500 ⁽⁷⁾	--	--	--	<50	<50	<50	<50	<50	<50	<50	<50	<50	<50	<50	<50	<50	<50	<50	<50
Sulphate (SO ₄)	µg/L	<100	--	--	--	--	4920	4140	4840	4780	1560	--	1020	1350	1350	1280	2880	3910	4520	3760	2910	3830
METALS																						
Aluminum (Al)	µg/L	<4	--	--	100 ⁽⁸⁾	75 ⁽⁹⁾	<u>106</u>	<u>103</u>	<u>97</u>	50	24	10	15	16	9	25	35	53	74	62	51	<u>167</u>
Antimony (Sb)	µg/L	<6	--	6	--	20	<6	<6	<6	<6	<6	<6	<6	<6	<6	<6	<6	<6	<6	<6	<6	<6
Arsenic (As)	µg/L	<3	--	25	5	5	<3	<3	<3	<3	<3	<3	<3	<3	<3	<3	<3	<3	<3	<3	<3	<3
Barium (Ba)	µg/L	<2	1000	--	--	--	4	7	3	3	3	4	229	5	4	3	3	3	11	11	10	3
Beryllium (Be)	µg/L	<1	--	--	--	11 ⁽¹⁰⁾	<1	<1	<1	<1	<1	<1	<1	<1	<1	<1	<1	<1	<1	<1	<1	<1
Boron (B)	µg/L	<10	--	5000	1500 ⁽¹¹⁾	200	<10	<10	<10	<10	<10	<10	<10	<10	<10	<10	<10	<10	<10	<10	<10	<10
Cadmium (Cd)	µg/L	<0.1	--	5	0.058 ⁽¹²⁾	0.1 ⁽¹³⁾	<0.1	<0.1	<0.1	<0.1	<0.1	<0.1	<0.1	<0.1	<0.1	<0.1	<0.1	<0.1	<0.1	<0.1	<0.1	<0.1
Chromium (Cr)	µg/L	<3	50	--	8.9 ⁽¹⁴⁾	8.9 ⁽¹⁴⁾	<3	<3	<3	<3	<3	<3	<3	<3	<3	<3	<3	<3	<3	<3	<3	<3
Cobalt (Co)	µg/L	<0.5	--	--	--	0.9	<0.5	<0.5	<0.5	<0.5	<0.5	<0.5	0.5	<0.5	<0.5	<0.5	<0.5	<0.5	0.9	0.9	0.7	<0.5
Copper (Cu)	µg/L	<2	--	--	2 ⁽¹⁵⁾	5 ⁽¹⁶⁾	<2	<2	<2	<2	<2	<2	<2	<2	<2	<2	<2	<2	<2	<2	<2	<2
Iron (Fe)	µg/L	<10	--	--	300	300	153	153	91	43	166	<u>339</u>	<u>1080</u>	<u>434</u>	101	76	70	113	<u>1750</u>	<u>2680</u>	<u>1750</u>	115
Lead (Pb)	µg/L	<1	10 ⁽¹⁷⁾	--	1 ⁽¹⁸⁾	3 ⁽¹⁹⁾	<1	<1	<1	<1	<1	<1	<1	<1	<1	<1	<1	<1	<1	<1	<1	<1
Manganese (Mn)	µg/L	<2	--	--	--	--	4	31	25	14	61	202	675	247	12	13	15	36	2780	1840	1660	43
Mercury (Hg)	µg/L	<0.10	1	--	0.026	0.2	<0.10	<0.10	<0.10	<0.10	<0.10	<0.10	<0.10	<0.10	<0.10	<0.10	<0.10	<0.10	<0.10	<0.10	<0.10	<0.10
Molybdenum (Mo)	µg/L	<2	--	--	73	40	<2	<2	<2	<2	<2	<2	<2	<2	<2	<2	<2	<2	<2	<2	<2	<2
Nickel (Ni)	µg/L	<3	--	--	25 ⁽²⁰⁾	25	<3	<3	<3	<3	<3	<3	<3	<3	<3	<3	<3	<3	<3	<3	<3	<3
Selenium (Se)	µg/L	<4	10	--	1	100	<4	<4	<4	<4	<4	<4	<4	<4	<4	<4	<4	<4	<4	<4	<4	<4
Silver (Ag)	µg/L	<0.1	--	--	0.1	0.1	<0.1	<0.1	<0.1	<0.1	<0.1	<0.1	<0.1	<0.1	<0.1	<0.1	<0.1	<0.1	<0.1	<0.1	<0.1	<0.1
Strontium (Sr)	µg/L	<5	--	--	--	--	13	17	13	14	23	27	33	33	26	18	18	21	28	24	23	13
Thallium (Tl)	µg/L	<0.3	--	--	0.8	0.3	<0.3	<0.3	<0.3	<0.3	<0.3	<0.3	<0.3	<0.3	<0.3	<0.3	<0.3	<0.3	<0.3	<0.3	<0.3	<0.3
Titanium (Ti)	µg/L	<2	--	--	--	--	<2	<2	<2	<2	<2	<2	<2	<2	<2	<2	<2	<2	<2	<2	<2	<2
Tungsten (W)	µg/L	<10	--	--	--	30	<10	<10	<10	<10	<10	<10	<10	<10	<10	<10	<10	<10	<10	<10	<10	<10
Uranium (U)	µg/L	<2	20	--	15	5	<2	<2	<2	<2	<2	<2	<2	<2	<2	<2	<2	<2	<2	<2	<2	<2
Vanadium (V)	µg/L	<2	--	--	--	6	<2	<2	<2	<2	<2	<2	<2	<2	<2	<2	<2	<2	<2	<2	<2	<2
Zinc (Zn)	µg/L	<5	--	--	30	20	<5	11	14	6	<u>31</u>	<5	<u>38</u>	15	<5	<5	<5	<5	<5	<5	<5	<5
Zirconium (Zr)	µg/L	<4	--	--	--	4	<4	<4	<4	<4	<4	<4	<4	<4	<4	<4	<4	<4	<4	<4	<4	<4
OTHER PARAMETERS																						
Total Cyanide	µg/L	<2	--	--	--	--	<2	<2	<2	<2	<2	--	<2	<2	<2	<2	<2	<2	<2	<2	<2	<2
Sulphur (S)	µg/L	<50	--	--	--	--	--	--	--	--	--	--	--	--	--	--	--	--	--	--	--	--
NUTRIENTS																						
Nitrate (NO ₃ ⁻)	µg/L as N	<50	10000	--	13000 ⁽²¹⁾	--	--	--	--	--	--	--	--	--	--	--	--	--	--	--	--	--
Nitrite (NO ₂ ⁻)	µg/L as N	<50	1000	--	60 ⁽²²⁾	--	--	--	--	--	--	--	--	--	--	--	--	--	--	--	--	--
Total Ammonia (NH ₃ + NH ₄)	µg/L as N	<20	--	--	6980	--	<20	40	<20	20	<20	40	130	40	<20	<20	<20	<20	180	290	250	<20
Un-ionized Ammonia (NH ₃)	µg/L	--	--	--	19 ⁽²³⁾	20 ⁽²³⁾	<0.01	0.01	<0.0072	0.1	<0.058	0.056	0.52	0.116	<0.04	<0.022	<0.026	<0.0166	0.0468	0.2407	0.2075	--
Total Kjeldahl Nitrogen	µg/L	<100	--	--	--	--	--	--	--	--	--	--	--	--	--	--	--	--	--	--	--	--
Total Phosphorus (P)	µg/L	<20	--	--	20	20	<20	<20	20	<20	<20	<u>50</u>	<u>70</u>	<u>40</u>	20	<20	<					

APPENDIX A
2011-2013 Surface Water Quality Results

Parameter ⁽¹⁾	Unit	Method Detection Limit	Ontario Drinking Water Standards ⁽²⁾⁽³⁾		Canadian Water Quality Guidelines ⁽⁴⁾	Provincial Water Quality Objective ⁽⁵⁾	BPD - Bagsverd Creek, near Bagsverd Lake Outflow												
			MAC	IMAC			26-Mar-12	26-Apr-12	31-May-12	28-Jun-12	18-Jul-12	20-Aug-12	24-Sep-12	23-Oct-12	19-Nov-12	17-Dec-12	29-Jan-13	24-Feb-13	19-Mar-13
FIELD PARAMETERS																			
pH	pH units	--	--	--	6.5-9	6.5-8.5	7.1	7.77	7.4	7.25	7.51	7.54	7.21	7.2	7.27	7.1	6.96	7.13	7.25
Temperature	degrees Celsius	--	--	--	--	-0.25	3.3	8.3	17.4	21.7	21.4	18.5	11.4	5.4	3.4	1.9	1	1	0.9
Conductivity	µS/cm	--	--	--	--	--	29.2	355	48	54.2	56.3	54.4	44.7	35.4	33.5	34.2	36.8	36.5	36.5
Dissolved Oxygen (DO)	µg/L	--	--	--	--	--	5570	2000	8580	7780	7540	8000	9230	10310	1246	1211	12410	11100	9900
GENERAL PARAMETERS																			
pH	pH units	--	--	--	6.5-9	6.5-8.5	7.11	6.99	6.7	7.34	6.83	6.99	7.16	6.88	6.88	6.8	6.68	6.47	6.76
Alkalinity	µg/L as CaCO3	<5000	--	--	--	-25%	20000	22000	22000	23000	24000	25000	23000	23000	22000	24000	25000	25000	26000
Acidity	µg/L as CaCO3	<5000	--	--	--	--	--	--	--	--	--	--	--	--	--	--	--	--	--
Electrical Conductivity (EC)	µS/cm	<2	--	--	--	--	50	53	57	56	58	61	60	56	54	58	67	66	68
Total Dissolved Solids (TDS)	µg/L	<20000	--	--	--	--	44000	52000	80000	44000	44000	62000	54000	60000	50000	58000	38000	38000	48000
Total Suspended Solids (TSS)	µg/L	<1000, <10000	--	--	+5000-25000 ⁽⁶⁾	--	<10000	<10000	<10000	<10000	<10000	<10000	<1000	<1000	<1000	<1000	<1000	<1000	<1000
Total Hardness	µg/L as CaCO3	<500	--	--	--	--	24000	25700	26800	24700	--	29800	33000	27900	27900	31000	31300	31000	30400
Dissolved Organic Carbon (DOC)	µg/L	<500	--	--	--	--	8100	8500	8200	11000	8300	6700	8100	8500	7900	7900	8700	8900	8600
Total Organic Carbon (TOC)	µg/L	<500	--	--	--	--	--	--	--	--	--	--	--	--	--	--	--	--	--
Chemical Oxygen Demand (COD)	µg/L	<5000	--	--	--	--	--	--	--	--	--	--	--	--	--	--	--	--	--
MAJOR IONS																			
Calcium (Ca)	µg/L	<50	--	--	--	--	7720	8260	8530	7870	9450	9520	10600	8930	9010	9870	9970	9910	9730
Magnesium (Mg)	µg/L	<50	--	--	--	--	1150	1230	1340	1220	1440	1460	1590	1350	1300	1540	1550	1510	1490
Potassium (K)	µg/L	<50	--	--	--	--	280	260	290	280	330	330	360	270	220	310	300	330	320
Sodium (Na)	µg/L	<50	--	--	--	--	620	695	910	650	770	710	800	710	860	760	780	780	770
Chloride (Cl)	µg/L	<100	--	--	--	--	210	300	340	240	350	310	440	340	350	370	320	410	390
Fluoride (F)	µg/L	<50	1500 ⁽⁷⁾	--	--	--	<50	<50	<50	<50	<50	<50	<50	<50	<50	<50	<50	<50	<50
Sulphate (SO ₄)	µg/L	<100	--	--	--	--	2790	2950	3000	2880	2760	2930	2750	2950	3130	3340	3570	3350	3210
METALS																			
Aluminum (Al)	µg/L	<4	--	--	100 ⁽⁸⁾	75 ⁽⁹⁾	19	24	14	15	9	7	6	10	11	9	8	8	7
Antimony (Sb)	µg/L	<6	--	6	--	20	<6	<6	<6	<6	<6	<6	<6	<6	<6	<6	<6	<6	<6
Arsenic (As)	µg/L	<3	--	25	5	5	<3	<3	<3	<3	<3	<3	<3	<3	<3	<3	<3	<3	<3
Barium (Ba)	µg/L	<2	1000	--	--	--	4	5	4	4	5	5	6	5	5	5	5	6	7
Beryllium (Be)	µg/L	<1	--	--	--	11 ⁽¹⁰⁾	<1	<1	<1	<1	<1	<1	<1	<1	<1	<1	<1	<1	<1
Boron (B)	µg/L	<10	--	5000	1500 ⁽¹¹⁾	200	<10	<10	<10	<10	<10	<10	<10	<10	<10	<10	<10	<10	<10
Cadmium (Cd)	µg/L	<0.1	--	5	0.058 ⁽¹²⁾	0.1 ⁽¹³⁾	<0.1	<0.1	<0.1	<0.1	<0.1	<0.1	<0.1	<0.1	<0.1	<0.1	<0.1	<0.1	<0.1
Chromium (Cr)	µg/L	<3	50	--	8.9 ⁽¹⁴⁾	8.9 ⁽¹⁴⁾	<3	<3	<3	<3	<3	<3	<3	<3	<3	<3	<3	<3	<3
Cobalt (Co)	µg/L	<0.5	--	--	--	0.9	<0.5	<0.5	<0.5	<0.5	<0.5	<0.5	<0.5	<0.5	<0.5	<0.5	<0.5	<0.5	<0.5
Copper (Cu)	µg/L	<2	--	--	2 ⁽¹⁵⁾	5 ⁽¹⁶⁾	<2	<2	<2	<2	<2	<2	<2	<2	<2	<2	<2	4	<2
Iron (Fe)	µg/L	<10	--	--	300	300	<10	40	<10	23	<10	29	<10	<10	23	52	21	22	<10
Lead (Pb)	µg/L	<1	10 ⁽¹⁷⁾	--	1 ⁽¹⁸⁾	3 ⁽¹⁹⁾	<1	<1	<1	<1	<1	<1	<1	<1	<1	<1	<1	<1	<1
Manganese (Mn)	µg/L	<2	--	--	--	--	12	13	22	29	37	48	32	30	14	14	11	9	12
Mercury (Hg)	µg/L	<0.10	1	--	0.026	0.2	<0.10	<0.1	<0.10	<0.10	<0.10	--	<0.10	<0.10	<0.10	<0.10	<0.10	<0.10	<0.10
Molybdenum (Mo)	µg/L	<2	--	--	73	40	<2	<2	<2	<2	<2	<2	<2	<2	<2	<2	<2	<2	<2
Nickel (Ni)	µg/L	<3	--	--	25 ⁽²⁰⁾	25	<3	<3	<3	<3	<3	<3	<3	<3	<3	<3	<3	<3	<3
Selenium (Se)	µg/L	<4	10	--	1	100	<4	<4	<4	<4	<4	<4	<4	<4	<4	<4	<4	<4	<4
Silver (Ag)	µg/L	<0.1	--	--	0.1	0.1	<0.1	<0.1	<0.1	<0.1	<0.1	<0.1	<0.1	<0.1	<0.1	<0.1	<0.1	<0.1	<0.1
Strontium (Sr)	µg/L	<5	--	--	--	--	17	20	19	21	22	24	26	21	18	22	24	21	24
Thallium (Tl)	µg/L	<0.3	--	--	0.8	0.3	<0.3	<0.3	<0.3	<0.3	<0.3	<0.3	<0.3	<0.3	<0.3	<0.3	<0.3	<0.3	<0.3
Titanium (Ti)	µg/L	<2	--	--	--	--	<2	<2	<2	<2	<2	<2	<2	<2	<2	<2	<2	<2	<2
Tungsten (W)	µg/L	<10	--	--	--	30	<10	<10	<10	<10	<10	<10	<10	<10	<10	<10	<10	<10	<10
Uranium (U)	µg/L	<2	20	--	15	5	<2	<2	<2	<2	<2	<2	<2	<2	<2	<2	<2	<2	<2
Vanadium (V)	µg/L	<2	--	--	--	6	<2	<2	<2	<2	<2	<2	<2	<2	<2	<2	<2	<2	<2
Zinc (Zn)	µg/L	<5	--	--	30	20	<5	33	6	<5	13	<5	<5	16	<5	<5	<5	<5	<5
Zirconium (Zr)	µg/L	<4	--	--	--	4	<4	<4	<4	<4	<4	<4	<4	<4	<4	<4	<4	<4	<4
OTHER PARAMETERS																			
Total Cyanide	µg/L	<2	--	--	--	--	<2	<2	<2	<2	<2	<2	<2	<2	<2	<2	<2	<2	<2
Sulphur (S)	µg/L	<50	--	--	--	--	--	--	--	--	--	--	--	--	--	--	--	--	--
NUTRIENTS																			
Nitrate (NO ₃ ⁻)	µg/L as N	<50	10000	--	13000 ⁽²¹⁾	--	--	--	--	--	--	--	--	--	--	--	--	--	--
Nitrite (NO ₂ ⁻)	µg/L as N	<50	1000	--	60 ⁽²²⁾	--	--	--	--	--	--	--	--	--	--	--	--	--	--
Total Ammonia (NH ₃ + NH ₄)	µg/L as N	<20	--	--	6980	--	<20	<20	<20	<20	<20	<20	<20	<20	<20	30	210	250	210
Un-ionized Ammonia (NH ₃)	µg/L	--	--	--	19 ⁽²³⁾	20 ⁽²³⁾	<0.022	<0.32	<0.2	<0.28	<0.26	<0.24	<0.04	<0.026	<0.068	0.0294	0.189	0.225	0.588
Total Kjeldahl Nitrogen	µg/L	<100	--	--	--	--	--	--	--	--	--	--	--	--	--	--	--	--	--
Total Phosphorus (P)	µg/L	<20	--	--	20	20	<20	20	<20	50	40	30	30	<20	<20	<20	<20	<20	<20
Phosphate (PO ₄)	µg/L as P	<100	--	--	--	--	--	--	--	--	--	--	--	--	--	<100	--	--	--
Soluble Reactive Phosphorus	µg/L	<20	--	--	--	--	--	--	--	--	--	--	--	--	--	--	--	--	--
ORGANICS																			
Oil and Grease (Animal/Vegetable)	µg/L	<500	--	--	--	--	--	--	--	--	--	--	--	--	--	--	--	--	--
Oil and Grease (Mineral)	µg/L	<500	--	--	--	--	--	--	--	--	--	--	--	--	--	--	--	--	--
Oil and Grease (Total)	µg/L	<500	--	--	--	physically non detect	--	--	--	--	--	--	--	--	--	--	--	--	--
RADIONUCLIDES																			
Radium-226	Bq/L	<0.001	0.6	--	--	1 ⁽²⁴⁾	--	--	--	--	--	--	--	--	<0.001	<0.001	<0.001	<0.001	<0.001

APPENDIX A
2011-2013 Surface Water Quality Results

Parameter ⁽¹⁾	Unit	Method Detection Limit	Ontario Drinking Water Standards ⁽²⁾⁽³⁾		Canadian Water Quality Guidelines ⁽⁴⁾	Provincial Water Quality Objective ⁽⁵⁾	(BAG-LS1) - Bagsverd Lake		
			MAC	IMAC			21-May-2013 (T)	21-May-2013 (T Dup)	21-May-2013 (B)
FIELD PARAMETERS									
pH	pH units	--	--	--	6.5-9	6.5-8.5	7.14	7.14	7.09
Temperature	degrees Celsius	--	--	--	--	-0.25	11.4	11.4	10.08
Conductivity	µS/cm	--	--	--	--	--	50	50	52
Dissolved Oxygen (DO)	µg/L	--	--	--	--	--	--	--	--
ORP	mV	--	--	--	--	--	204.3	204.3	208.4
GENERAL PARAMETERS									
pH	pH units	--	--	--	6.5-9	6.5-8.5	6.49	6.43	6.83
Alkalinity	µg/L as CaCO ₃	<5000	--	--	--	-25%	19000	19000	23000
Acidity	µg/L as CaCO ₃	<5000	--	--	--	--	<5000	<5000	<5000
Electrical Conductivity (EC)	µS/cm	<2	--	--	--	--	55	55	58
Total Dissolved Solids (TDS)	µg/L	<20000	--	--	--	--	52000	56000	40000
Total Suspended Solids (TSS)	µg/L	<1000, <10000	--	--	+5000-25000 ⁽⁶⁾	--	<10000	<10000	<10000
Total Hardness	µg/L as CaCO ₃	<500	--	--	--	--	26100	26000	26700
Dissolved Organic Carbon (DOC)	µg/L	<500	--	--	--	--	8900	8900	9000
Total Organic Carbon (TOC)	µg/L	<500	--	--	--	--	9500	9300	9300
Chemical Oxygen Demand (COD)	µg/L	<5000	--	--	--	--	--	--	--
MAJOR IONS									
Calcium (Ca)	µg/L	<50	--	--	--	--	8390	8320	8600
Magnesium (Mg)	µg/L	<50	--	--	--	--	1250	1260	1280
Potassium (K)	µg/L	<50	--	--	--	--	330	370	310
Sodium (Na)	µg/L	<50	--	--	--	--	670	680	680
Chloride (Cl)	µg/L	<100	--	--	--	--	240	270	300
Fluoride (F)	µg/L	<50	1500 ⁽⁷⁾	--	--	--	<50	<50	<50
Sulphate (SO ₄)	µg/L	<100	--	--	--	--	3020	3040	3080
METALS									
Aluminum (Al)	µg/L	<4	--	--	100 ⁽⁸⁾	75 ⁽⁹⁾	53	47	36
Antimony (Sb)	µg/L	<6	--	6	--	20	<3	<3	<3
Arsenic (As)	µg/L	<3	--	25	5	5	<3	<3	<3
Barium (Ba)	µg/L	<2	1000	--	--	--	5	5	5
Beryllium (Be)	µg/L	<1	--	--	--	11 ⁽¹⁰⁾	<1	<1	<1
Boron (B)	µg/L	<10	--	5000	1500 ⁽¹¹⁾	200	<10	<10	<10
Cadmium (Cd)	µg/L	<0.1	--	5	0.058 ⁽¹²⁾	0.1 ⁽¹³⁾	<0.1	<0.1	<0.1
Chromium (Cr)	µg/L	<3	50	--	8.9 ⁽¹⁴⁾	8.9 ⁽¹⁴⁾	<3	<3	<3
Cobalt (Co)	µg/L	<0.5	--	--	--	0.9	<0.5	<0.5	<0.5
Copper (Cu)	µg/L	<2	--	--	2 ⁽¹⁵⁾	5 ⁽¹⁶⁾	<2	<2	<2
Iron (Fe)	µg/L	<10	--	--	300	300	<10	<10	10
Lead (Pb)	µg/L	<1	10 ⁽¹⁷⁾	--	1 ⁽¹⁸⁾	3 ⁽¹⁹⁾	<1	<1	<1
Manganese (Mn)	µg/L	<2	--	--	--	--	29	29	34
Mercury (Hg)	µg/L	<0.10	1	--	0.026	0.2	<0.1	<0.1	<0.1
Molybdenum (Mo)	µg/L	<2	--	--	73	40	<2	<2	<2
Nickel (Ni)	µg/L	<3	--	--	25 ⁽²⁰⁾	25	<3	<3	<3
Selenium (Se)	µg/L	<4	10	--	1	100	<4	<4	<4
Silver (Ag)	µg/L	<0.1	--	--	0.1	0.1	<0.1	<0.1	<0.1
Strontium (Sr)	µg/L	<5	--	--	--	--	19	19	19
Thallium (Tl)	µg/L	<0.3	--	--	0.8	0.3	<0.3	<0.3	<0.3
Titanium (Ti)	µg/L	<2	--	--	--	--	<2	<2	<2
Tungsten (W)	µg/L	<10	--	--	--	30	<10	<10	<10
Uranium (U)	µg/L	<2	20	--	15	5	<2	<2	<2
Vanadium (V)	µg/L	<2	--	--	--	6	<2	<2	<2
Zinc (Zn)	µg/L	<5	--	--	30	20	<5	<5	<5
Zirconium (Zr)	µg/L	<4	--	--	--	4	<4	<4	<4
OTHER PARAMETERS									
Total Cyanide	µg/L	<2	--	--	--	--	<2	<2	<2
Free Cyanide	µg/L	<2	--	--	5	5	<2	<2	<2
Phenols	µg/L	<1	--	--	--	--	<1	<1	--
Sulphur (S)	µg/L	<50	--	--	--	--	--	--	--
Total Ammonia (NH₃ + NH₄)									
Nitrate (NO ₃ ⁻)	µg/L as N	<50	10000	--	13000 ⁽²¹⁾	--	160	150	180
Nitrite (NO ₂ ⁻)	µg/L as N	<50	1000	--	60 ⁽²²⁾	--	<50	<50	<50
Total Phosphorus (P)	µg/L as N	<20	--	--	6980	--	70	70	70
Un-ionized Ammonia (NH ₃)	µg/L	--	--	--	19 ⁽²³⁾	20 ⁽²³⁾	--	--	--
Total Kjeldahl Nitrogen	µg/L	<100	--	--	--	--	--	--	--
Total Phosphorus (TP)	µg/L	<20	--	--	20	20	<20	20	20
Phosphate (PO ₄)	µg/L as P	<100	--	--	--	--	--	--	--
Soluble Reactive Phosphorus	µg/L	<20	--	--	--	--	--	--	--
ORGANICS									
Oil and Grease (Animal/Vegetable)	µg/L	<500	--	--	--	--	<500	<500	--
Oil and Grease (Mineral)	µg/L	<500	--	--	--	--	<500	<500	--
Oil and Grease (Total)	µg/L	<500	--	--	--	physically non detect	<500	<500	--
Polychlorinated Biphenyls	µg/L	<0.1	--	0.003	--	0.001	<0.1	<0.1	--
Naphthalene	µg/L	<0.2	--	--	1.1	7	<0.2	<0.2	--
Acenaphthylene	µg/L	<0.2	--	--	--	--	<0.2	<0.2	--
Acenaphthene	µg/L	<0.2	--	--	5.8	--	<0.2	<0.2	--
Fluorene	µg/L	<0.2	--	--	3	0.2	<0.2	<0.2	--
Phenanthrene	µg/L	<0.1	--	--	0.4	0.03	<0.1	<0.1	--
Anthracene	µg/L	<0.1	--	--	0.012	0.0008	<0.1	<0.1	--
Fluoranthene	µg/L	<0.2	--	--	0.04	0.0008	<0.2	<0.2	--
Pyrene	µg/L	<0.2	--	--	0.025	--	<0.2	<0.2	--
Benz(a)anthracene	µg/L	<0.2	--	--	0.018	0.0004	<0.2	<0.2	--
Chrysene	µg/L	<0.1	--	--	--	0.0001	<0.1	<0.1	--
Benzo(b)fluoranthene	µg/L	<0.1	--	--	--	--	<0.1	<0.1	--
Benzo(k)fluoranthene	µg/L	<0.1	--	--	--	0.0002	<0.1	<0.1	--
Benzo(a)pyrene	µg/L	<0.01	--	--	0.015	--	<0.01	<0.01	--
Indeno(1,2,3-cd)pyrene	µg/L	<0.2	--	--	--	--	<0.2	<0.2	--
Dibenz(a,h)anthracene	µg/L	<0.2	--	--	--	0.002	<0.2	<0.2	--
Benzo(g,h,i)perylene	µg/L	<0.2	--	--	--	0.00002	<0.2	<0.2	--
2-and 1-methyl Naphthalene	µg/L	<0.2	--	--	--	--	<0.2	<0.2	--
RADIONUCLIDES									
Radium-226	Bq/L	<0.001	0.6	--	--	1 ⁽²⁴⁾	--	--	--
MICROBIOLOGICAL									
Escherichia coli	CFU/100mL	1	--	--	--	100	2	ND	--
Total Coliforms	CFU/100mL	1	--	--	--	--	33	48	--

APPENDIX A
2011-2013 Surface Water Quality Results

Parameter ⁽¹⁾	Unit	Method Detection Limit	Ontario Drinking Water Standards ⁽²⁾⁽³⁾		Canadian Water Quality Guidelines ⁽⁴⁾	Provincial Water Quality Objective ⁽⁵⁾	L-2 - Inflow to Bagsverd Creek													
			MAC	IMAC			26-Mar-12	26-Apr-12	23-May-12	26-Jun-12	18-Jul-12	20-Aug-12	24-Sep-12	30-Oct-12	19-Nov-12	17-Dec-12	29-Jan-13	24-Feb-13	19-Mar-13	24-Apr-13
FIELD PARAMETERS																				
pH	pH units	--	--	--	6.5-9	6.5-8.5	6.5	7.5	7.02	6.98	6.91	6.82	6.92	6.81	7.04	7.01	6.48	6.77	6.56	6.35
Temperature	degrees Celsius	--	--	--	--	-0.25	3.1	9.8	17.3	20.6	23.4	18.5	9.4	4	4.3	1.4	0.5	0.6	0.5	1.3
Conductivity	µS/cm	--	--	--	--	--	20.3	22.7	27.2	33.7	37.1	33.5	26	22.5	23.3	22.7	23.6	24	24.4	19.2
Dissolved Oxygen (DO)	µg/L	--	--	--	--	--	2420	2000	8800	8050	7610	7180	9320	10700	1183	1236	10300	9130	8010	1154
GENERAL PARAMETERS																				
pH	pH units	--	--	--	6.5-9	6.5-8.5	6.61	6.81	6.61	6.91	6.54	6.33	6.78	6.22	6.57	6.59	6.42	6.08	6.63	6.16
Alkalinity	µg/L as CaCO3	<5000	--	--	--	-25%	9000	9000	10000	10000	11000	11000	11000	11000	11000	11000	12000	13000	25000	7000
Acidity	µg/L as CaCO3	<5000	--	--	--	--	--	--	--	--	--	--	--	--	--	--	--	--	--	--
Electrical Conductivity (EC)	µS/cm	<2	--	--	--	--	35	33	34	36	37	39	37	37	40	44	44	44	66	35
Total Dissolved Solids (TDS)	µg/L	<20000	--	--	--	--	50000	52000	42000	38000	38000	52000	44000	34000	48000	62000	52000	20000	48000	58000
Total Suspended Solids (TSS)	µg/L	<1000, <10000	--	--	+5000-25000 ⁽⁶⁾	--	<10000	<10000	<10000	<10000	<10000	<10000	<10000	3000	1000	1000	<1000	<1000	<1000	3000
Total Hardness	µg/L as CaCO3	<500	--	--	--	--	16800	15500	16600	15800	17500	19900	18300	19000	20900	21000	21600	21300	17400	
Dissolved Organic Carbon (DOC)	µg/L	<500	--	--	--	--	13900	12500	12700	14400	11900	9200	11200	12700	12500	14100	13900	14200	16000	
Total Organic Carbon (TOC)	µg/L	<500	--	--	--	--	--	--	--	--	--	--	--	--	--	--	--	--	--	
Chemical Oxygen Demand (COD)	µg/L	<5000	--	--	--	--	--	--	--	--	--	--	--	--	--	--	--	--	--	
MAJOR IONS																				
Calcium (Ca)	µg/L	<50	--	--	--	--	4560	4210	4520	4280	4770	5020	5410	5020	5300	5690	5740	5940	5840	4650
Magnesium (Mg)	µg/L	<50	--	--	--	--	1310	1210	1300	1230	1360	1450	1540	1410	1390	1620	1630	1650	1640	1410
Potassium (K)	µg/L	<50	--	--	--	--	280	240	260	250	280	250	290	240	330	260	240	310	270	520
Sodium (Na)	µg/L	<50	--	--	--	--	820	860	850	800	880	860	950	900	1070	970	950	1020	950	870
Chloride (Cl)	µg/L	<100	--	--	--	--	320	310	280	250	310	280	370	350	360	400	380	350	380	350
Fluoride (F)	µg/L	<50	1500 ⁽⁷⁾	--	--	--	<50	<50	<50	<50	<50	<50	<50	<50	<50	<50	<50	<50	<50	<50
Sulphate (SO ₄)	µg/L	<100	--	--	--	--	3130	2660	2500	2630	2740	2730	2600	2730	3180	3230	3060	2890	2740	2860
METALS																				
Aluminum (Al)	µg/L	<4	--	--	100 ⁽⁸⁾	75 ⁽⁹⁾	121	114	89	62	38	31	38	67	80	88	104	96	94	185
Antimony (Sb)	µg/L	<6	--	6	--	20	<6	<6	<6	<6	<6	<6	<6	<6	<6	<6	<6	<6	<6	<6
Arsenic (As)	µg/L	<3	--	25	5	5	<3	<3	<3	<3	<3	<3	<3	<3	<3	<3	<3	<3	<3	<3
Barium (Ba)	µg/L	<2	1000	--	--	--	4	4	4	3	3	3	4	4	4	4	4	4	5	5
Beryllium (Be)	µg/L	<1	--	--	--	11 ⁽¹⁰⁾	<1	<1	<1	<1	<1	<1	<1	<1	<1	<1	<1	<1	<1	<1
Boron (B)	µg/L	<10	--	5000	1500 ⁽¹¹⁾	200	<10	<10	<10	<10	<10	<10	<10	<10	<10	<10	<10	<10	<10	<10
Cadmium (Cd)	µg/L	<0.1	--	5	0.058 ⁽¹²⁾	0.1 ⁽¹³⁾	<0.1	<0.1	<0.1	<0.1	<0.1	<0.1	<0.1	<0.1	<0.1	<0.1	<0.1	<0.1	<0.1	<0.1
Chromium (Cr)	µg/L	<3	50	--	8.9 ⁽¹⁴⁾	8.9 ⁽¹⁴⁾	<3	<3	<3	<3	<3	<3	<3	<3	<3	<3	<3	<3	<3	<3
Cobalt (Co)	µg/L	<0.5	--	--	--	0.9	<0.5	<0.5	<0.5	<0.5	<0.5	<0.5	<0.5	<0.5	<0.5	<0.5	<0.5	<0.5	<0.5	<0.5
Copper (Cu)	µg/L	<2	--	--	2 ⁽¹⁵⁾	5 ⁽¹⁶⁾	<2	<2	<2	<2	<2	<2	<2	<2	<2	<2	<2	<2	<2	<2
Iron (Fe)	µg/L	<10	--	--	300	300	320	202	189	120	132	150	183	296	283	256	254	259	257	327
Lead (Pb)	µg/L	<1	10 ⁽¹⁷⁾	--	1 ⁽¹⁸⁾	3 ⁽¹⁹⁾	<1	<1	<1	<1	<1	<1	<1	<1	<1	<1	<1	<1	<1	<1
Manganese (Mn)	µg/L	<2	--	--	--	--	33	12	21	19	26	30	16	16	11	9	12	17	30	27
Mercury (Hg)	µg/L	<0.10	1	--	0.026	0.2	<0.10	<0.1	<0.10	<0.10	<0.10	--	<0.10	<0.10	<0.10	<0.10	<0.10	<0.10	<0.10	<0.10
Molybdenum (Mo)	µg/L	<2	--	--	73	40	<2	<2	<2	<2	<2	<2	<2	<2	<2	<2	<2	<2	<2	<2
Nickel (Ni)	µg/L	<3	--	--	25 ⁽²⁰⁾	25	<3	<3	<3	<3	<3	<3	<3	<3	<3	<3	<3	<3	<3	<3
Selenium (Se)	µg/L	<4	10	--	1	100	<4	<4	<4	<4	<4	<4	<4	<4	<4	<4	<4	<4	<4	<4
Silver (Ag)	µg/L	<0.1	--	--	0.1	0.1	<0.1	<0.1	<0.1	<0.1	<0.1	<0.1	<0.1	<0.1	<0.1	<0.1	<0.1	<0.1	<0.1	<0.1
Strontium (Sr)	µg/L	<5	--	--	--	--	13	12	15	16	15	16	16	14	13	15	18	15	16	13
Thallium (Tl)	µg/L	<0.3	--	--	0.8	0.3	<0.3	<0.3	<0.3	<0.3	<0.3	<0.3	<0.3	<0.3	<0.3	<0.3	<0.3	<0.3	<0.3	<0.3
Titanium (Ti)	µg/L	<2	--	--	--	--	<2	<2	<2	<2	<2	<2	<2	<2	<2	<2	<2	<2	<2	3
Tungsten (W)	µg/L	<10	--	--	--	30	<10	<10	<10	<10	<10	<10	<10	<10	<10	<10	<10	<10	<10	<10
Uranium (U)	µg/L	<2	20	--	15	5	<2	<2	<2	<2	<2	<2	<2	<2	<2	<2	<2	<2	<2	<2
Vanadium (V)	µg/L	<2	--	--	--	6	<2	<2	<2	<2	<2	<2	<2	<2	<2	<2	<2	<2	<2	<2
Zinc (Zn)	µg/L	<5	--	--	30	20	<5	7	54	58	<5	6	<5	<5	<5	20	<5	<5	11	
Zirconium (Zr)	µg/L	<4	--	--	--	4	<4	<4	<4	<4	<4	<4	<4	<4	<4	<4	<4	<4	<4	<4
OTHER PARAMETERS																				
Total Cyanide	µg/L	<2	--	--	--	--	<2	<2	<2	<2	<2	<2	<2	<2	<2	<2	<2	<2	<2	<2
Sulphur (S)	µg/L	<50	--	--	--	--	--	--	--	--	--	--	--	--	--	--	--	--	--	--
NUTRIENTS																				
Nitrate (NO ₃ ⁻)	µg/L as N	<50	10000	--	13000 ⁽²¹⁾	--	--	--	--	--	--	--	--	--	--	--	--	--	--	--
Nitrite (NO ₂ ⁻)	µg/L as N	<50	1000	--	60 ⁽²²⁾	--	--	--	--	--	--	--	--	--	--	--	--	--	--	--
Total Ammonia (NH ₃ + NH ₄)	µg/L as N	<20	--	--	6980	--	<20	<20	<20	<20	<20	<20	60	<20	20	30	20	20	20	60
Un-ionized Ammonia (NH ₃)	µg/L	--	--	--	19 ⁽²³⁾	20 ⁽²³⁾	<0.0068	<0.118	<0.064	<0.086	<0.098	<0.074	0.102	<0.024	0.024	0.027	0.0056	0.018	0.0056	--
Total Kjeldahl Nitrogen	µg/L	<100	--	--	--	--	--	--	--	--	--	--	--	--	--	--	--	--	--	--
Total Phosphorus (P)	µg/L	<20	--	--	20	20	20	30	40	40	30	30	<20	<20	<20	<20	<20	<20	<20	<20
Phosphate (PO ₄)	µg/L as P	<100	--	--	--	--	--	--	--	--	--	--	--	--	<100	--	--	--	--	<100
Soluble Reactive Phosphorus	µg/L	<20	--	--	--	--	--	--	--	--	--	--	--	--	--	--	--	--	--	--
ORGANICS																				
Oil and Grease (Animal/Vegetable)	µg/L	<500	--	--	--	--	--	--	--	--	--	--	--	--	--	--	--	--	--	--
Oil and Grease (Mineral)	µg/L	<500	--	--	--	--	--	--	--	--	--	--	--	--	--	--	--	--	--	--
Oil and Grease (Total)	µg/L	<500	--	--	--	physically non detect	--	--	--	--	--	--	--	--	--	--	--	--	--	--
RADIONUCLIDES																				
Radium-226	Bq/L	<0.001	0.6	--	--	1 ⁽²⁴⁾	--	--	--	--	--	--	--	--	<0.001	<0.001	<0.001			

APPENDIX A
2011-2013 Surface Water Quality Results

Parameter ⁽¹⁾	Unit	Method Detection Limit	Ontario Drinking Water Standards ⁽²⁾⁽³⁾		Canadian Water Quality Guidelines ⁽⁴⁾	Provincial Water Quality Objective ⁽⁵⁾	BL-b - Bagsverd Creek, near Neville Lake Inflow															
			MAC	IMAC			24-Jan-12	21-Feb-12	26-Mar-12	26-Apr-12	23-May-12	26-Jun-12	18-Jul-12	20-Aug-12	24-Sep-12	30-Oct-12	19-Nov-12	17-Dec-12	29-Jan-13	24-Feb-13	19-Mar-13	24-Apr-13
FIELD PARAMETERS																						
pH	pH units	--	--	--	6.5-9	6.5-8.5	--	7.17	6.43	7.7	6.81	7.15	6.89	6.7	6.77	6.66	6.8	6.8	6.61	6.92	6.95	6.35
Temperature	degrees Celsius	--	--	--	--	-0.25	--	-0.1	1	4.9	7.18	20.3	20.4	15.3	8.4	3.9	2.6	0.5	-0.3	-0.3	-0.4	1.1
Conductivity	µS/cm	--	--	--	--	--	--	31.6	16.4	25	43.6	55.4	58.6	52	36	25.9	24.3	27	33.9	34	34.1	16.5
Dissolved Oxygen (DO)	µg/L	--	--	--	--	--	--	9670	3380	4500	16700	7160	6050	7250	7600	10200	1070	1040	10800	10860	10160	1246
GENERAL PARAMETERS																						
pH	pH units	--	--	--	6.5-9	6.5-8.5	6.96	7.07	6.47	6.73	6.85	7.29	6.78	6.85	6.65	5.75	6.42	6.58	6.55	6.26	6.63	6.1
Alkalinity	µg/L as CaCO3	<5000	--	--	--	-25%	23000	25000	8000	13000	22000	25000	25000	25000	15000	12000	11000	16000	24000	24000	25000	7000
Acidity	µg/L as CaCO3	<5000	--	--	--	--	--	--	--	--	--	--	--	--	--	--	--	--	--	--	--	--
Electrical Conductivity (EC)	µS/cm	<2	--	--	--	--	61	61	30	41	51	60	61	63	52	45	40	49	64	64	66	30
Total Dissolved Solids (TDS)	µg/L	<20000	--	--	--	--	28000	36000	56000	56000	50000	42000	50000	86000	92000	94000	76000	64000	72000	64000	48000	46000
Total Suspended Solids (TSS)	µg/L	<1000, <10000	--	--	+5000-25000 ⁽⁶⁾	--	<10000	<10000	<10000	<10000	<10000	<10000	<10000	<10000	<10000	<10000	<10000	<10000	<10000	2000	<1000	3000
Total Hardness	µg/L as CaCO3	<500	--	--	--	--	29000	29600	14700	20300	26300		30200	33200	33400	24600	23300	26600	27900	30200	30100	15900
Dissolved Organic Carbon (DOC)	µg/L	<500	--	--	--	--	12300	13600	12800	11900	12400	13200	9700	12600	27000	28100	19400	12500	10700	10000	10400	16200
Total Organic Carbon (TOC)	µg/L	<500	--	--	--	--	--	--	--	--	--	--	--	--	--	--	--	--	--	--	--	--
Chemical Oxygen Demand (COD)	µg/L	<5000	--	--	--	--	--	--	--	--	--	--	--	--	--	--	--	--	--	--	--	--
MAJOR IONS																						
Calcium (Ca)	µg/L	<50	--	--	--	--	9050	9280	4310	6210	8080	8180	9360	10000	9980	7330	7070	8070	8640	9420	9360	4620
Magnesium (Mg)	µg/L	<50	--	--	--	--	1560	1560	960	1170	1490	1450	1650	1990	2070	1540	1360	1570	1540	1630	1640	1070
Potassium (K)	µg/L	<50	--	--	--	--	380	310	270	240	270	270	240	230	280	190	200	220	240	330	350	490
Sodium (Na)	µg/L	<50	--	--	--	--	820	830	630	710	810	770	870	880	930	880	980	850	800	850	840	620
Chloride (Cl)	µg/L	<100	--	--	--	--	400	410	250	300	350	430	520	760	550	450	370	420	420	360	380	280
Fluoride (F)	µg/L	<50	1500 ⁽⁷⁾	--	--	--	<50	<50	<50	<50	<50	<50	<50	<50	<50	<50	<50	<50	<50	<50	<50	<50
Sulphate (SO ₄)	µg/L	<100	--	--	--	--	3000	2890	2820	2740	2420	2510	2860	2320	1850	2780	2920	3270	3460	3120	3070	2220
METALS																						
Aluminum (Al)	µg/L	<4	--	--	100 ⁽⁸⁾	75 ⁽⁹⁾	30	32	83	70	40	26	11	52	140	149	113	70	34	31	49	121
Antimony (Sb)	µg/L	<6	--	6	--	20	<6	<6	<6	<6	<6	<6	<6	<6	<6	<6	<6	<6	<6	<6	<6	<6
Arsenic (As)	µg/L	<3	--	25	5	5	<3	<3	<3	<3	<3	<3	<3	<3	<3	<3	<3	<3	<3	<3	<3	<3
Barium (Ba)	µg/L	<2	1000	--	--	--	5	5	3	3	4	4	5	6	8	5	4	4	5	6	6	5
Beryllium (Be)	µg/L	<1	--	--	--	11 ⁽¹⁰⁾	<1	<1	<1	<1	<1	<1	<1	<1	<1	<1	<1	<1	<1	<1	<1	<1
Boron (B)	µg/L	<10	--	5000	1500 ⁽¹¹⁾	200	<10	<10	<10	<10	<10	<10	<10	<10	<10	<10	<10	<10	<10	<10	<10	<10
Cadmium (Cd)	µg/L	<0.1	--	5	0.058 ⁽¹²⁾	0.1 ⁽¹³⁾	<0.1	<0.1	<0.1	<0.1	<0.1	<0.1	<0.1	<0.1	<0.1	<0.1	<0.1	<0.1	<0.1	<0.1	<0.1	<0.1
Chromium (Cr)	µg/L	<3	50	--	8.9 ⁽¹⁴⁾	8.9 ⁽¹⁴⁾	<3	<3	<3	<3	<3	<3	<3	<3	<3	<3	<3	<3	<3	<3	<3	<3
Cobalt (Co)	µg/L	<0.5	--	--	--	0.9	<0.5	<0.5	<0.5	<0.5	<0.5	<0.5	<0.5	<0.5	<0.5	<0.5	<0.5	<0.5	<0.5	<0.5	<0.5	<0.5
Copper (Cu)	µg/L	<2	--	--	2 ⁽¹⁵⁾	5 ⁽¹⁶⁾	<2	<2	<2	<2	<2	<2	<2	<2	<2	<2	<2	<2	<2	<2	<2	<2
Iron (Fe)	µg/L	<10	--	--	300	300	101	112	133	122	150	133	97	265	570	371	262	186	128	141	141	211
Lead (Pb)	µg/L	<1	10 ⁽¹⁷⁾	--	1 ⁽¹⁸⁾	3 ⁽¹⁹⁾	<1	<1	<1	<1	<1	<1	<1	<1	<1	<1	<1	<1	<1	<1	<1	<1
Manganese (Mn)	µg/L	<2	--	--	--	--	<2	12	6	8	41	50	43	45	45	27	13	19	16	16	20	66
Mercury (Hg)	µg/L	<0.10	1	--	0.026	0.2	<0.10	<0.10	<0.10	<0.10	<0.10	<0.10	<0.10	--	<0.10	<0.10	<0.10	<0.10	<0.10	<0.10	<0.10	<0.10
Molybdenum (Mo)	µg/L	<2	--	--	73	40	<2	<2	<2	<2	<2	<2	<2	<2	<2	<2	<2	<2	<2	<2	<2	<2
Nickel (Ni)	µg/L	<3	--	--	25 ⁽²⁰⁾	25	<3	<3	<3	<3	<3	<3	<3	3	<3	<3	<3	<3	<3	<3	<3	<3
Selenium (Se)	µg/L	<4	10	--	1	100	<4	<4	<4	<4	<4	<4	<4	<4	<4	<4	<4	<4	<4	<4	<4	<4
Silver (Ag)	µg/L	<0.1	--	--	0.1	0.1	<0.1	<0.1	<0.1	<0.1	<0.1	<0.1	<0.1	<0.1	<0.1	<0.1	<0.1	<0.1	<0.1	<0.1	<0.1	<0.1
Strontium (Sr)	µg/L	<5	--	--	--	--	21	22	10	14	19	23	24	26	26	18	16	19	22	21	23	11
Thallium (Tl)	µg/L	<0.3	--	--	0.8	0.3	<0.3	<0.3	<0.3	<0.3	<0.3	<0.3	<0.3	<0.3	<0.3	<0.3	<0.3	<0.3	<0.3	<0.3	<0.3	<0.3
Titanium (Ti)	µg/L	<2	--	--	--	--	<2	<2	<2	<2	<2	<2	<2	<2	2	2	2	<2	<2	<2	<2	2
Tungsten (W)	µg/L	<10	--	--	--	30	<10	<10	<10	<10	<10	<10	<10	<10	<10	<10	<10	<10	<10	<10	<10	<10
Uranium (U)	µg/L	<2	20	--	15	5	<2	<2	<2	<2	<2	<2	<2	<2	<2	<2	<2	<2	<2	<2	<2	<2
Vanadium (V)	µg/L	<2	--	--	--	6	<2	<2	<2	<2	<2	<2	<2	<2	<2	<2	<2	<2	<2	<2	<2	<2
Zinc (Zn)	µg/L	<5	--	--	30	20	32	23	5	<5	<5	6	12	<5	9	<5	<5	<5	<5	<5	<5	<5
Zirconium (Zr)	µg/L	<4	--	--	--	4	<4	<4	<4	<4	<4	<4	<4	<4	<4	<4	<4	<4	<4	<4	<4	<4
OTHER PARAMETERS																						
Total Cyanide	µg/L	<2	--	--	--	--	<2	<2	<2	<2	<2	<2	<2	<2	<2	<2	<2	<2	<2	<2	<2	<2
Sulphur (S)	µg/L	<50	--	--	--	--	--	--	--	--	--	--	--	--	--	--	--	--	--	--	--	--
NUTRIENTS																						
Nitrate (NO ₃ ⁻)	µg/L as N	<50	10000	--	13000 ⁽²¹⁾	--	--	--	--	--	--	--	--	--	--	--	--	--	--	--	--	--
Nitrite (NO ₂ ⁻)	µg/L as N	<50	1000	--	60 ⁽²²⁾	--	--	--	--	--	--	--	--	--	--	--	--	--	--	--	--	--
Total Ammonia (NH ₃ + NH ₄)	µg/L as N	<20	--	--	6980	--	30	<20	<20	<20	<20	<20	<20	<20	<20	<20	30	30	180	210	140	70
Un-ionized Ammonia (NH ₃)	µg/L	--	--	--	19 ⁽²³⁾	20 ⁽²³⁾	--	<0.0166	<0.0056	<0.078	<0.03	<0.08	<0.08	<0.0174	<0.032	<0.0072	0.033	0.027	0.0468	0.1743	0.1162	--
Total Kjeldahl Nitrogen	µg/L	<100	--	--	--	--	--	--	--	--	--	--	--	--	--	--	--	--	--	--	--	--
Total Phosphorus (P)	µg/L	<20	--	--	20	20	30	<20	<20	20	40	40	40	50	30	<						

**APPENDIX A
2011-2013 Surface Water Quality Results**

Parameter ⁽¹⁾	Unit	Method Detection Limit	Ontario Drinking Water Standards ⁽²⁾⁽³⁾		Canadian Water Quality Guidelines ⁽⁴⁾	Provincial Water Quality Objective ⁽⁵⁾	WL-1 - Wolf Lake Outlet			
			MAC	IMAC			23-May-12	20-Aug-12	19-Nov-12	24-Feb-13
FIELD PARAMETERS										
pH	pH units	--	--	--	6.5-9	6.5-8.5	7.21	7.66	7.64	6.95
Temperature	degrees Celsius	--	--	--	--	-0.25	17.3	17.8	3	-0.1
Conductivity	µS/cm	--	--	--	--	--	34.6	38.9	25.9	29.1
Dissolved Oxygen (DO)	µg/L	--	--	--	--	--	8080	7520	1195	12600
GENERAL PARAMETERS										
pH	pH units	--	--	--	6.5-9	6.5-8.5	6.77	6.87	6.62	6.54
Alkalinity	µg/L as CaCO ₃	<5000	--	--	--	-25%	24000	16000	14000	18000
Acidity	µg/L as CaCO ₃	<5000	--	--	--	--	--	--	--	--
Electrical Conductivity (EC)	µS/cm	<2	--	--	--	--	41	46	43	56
Total Dissolved Solids (TDS)	µg/L	<20000	--	--	--	--	36000	62000	56000	26000
Total Suspended Solids (TSS)	µg/L	<1000, <10000	--	--	+5000-25000 ⁽⁶⁾	--	<10000	<10000	<1000	<1000
Total Hardness	µg/L as CaCO ₃	<500	--	--	--	--	19000	21100	22200	26100
Dissolved Organic Carbon (DOC)	µg/L	<500	--	--	--	--	8700	7000	13500	8600
Total Organic Carbon (TOC)	µg/L	<500	--	--	--	--	--	--	--	--
Chemical Oxygen Demand (COD)	µg/L	<5000	--	--	--	--	--	--	--	--
MAJOR IONS										
Calcium (Ca)	µg/L	<50	--	--	--	--	5240	5790	6310	7320
Magnesium (Mg)	µg/L	<50	--	--	--	--	1430	1610	1570	1890
Potassium (K)	µg/L	<50	--	--	--	--	330	280	420	390
Sodium (Na)	µg/L	<50	--	--	--	--	880	870	1140	1040
Chloride (Cl)	µg/L	<100	--	--	--	--	470	370	480	500
Fluoride (F)	µg/L	<50	1500 ⁽⁷⁾	--	--	--	50	<50	<50	<50
Sulphate (SO ₄)	µg/L	<100	--	--	--	--	3230	2980	2850	4040
METALS										
Aluminum (Al)	µg/L	<4	--	--	100 ⁽⁸⁾	75 ⁽⁹⁾	36	11	66	36
Antimony (Sb)	µg/L	<6	--	6	--	20	<6	<6	<6	<6
Arsenic (As)	µg/L	<3	--	25	5	5	<3	<3	<3	<3
Barium (Ba)	µg/L	<2	1000	--	--	--	4	4	4	5
Beryllium (Be)	µg/L	<1	--	--	--	11 ⁽¹⁰⁾	<1	<1	<1	<1
Boron (B)	µg/L	<10	--	5000	1500 ⁽¹¹⁾	200	<10	<10	<10	<10
Cadmium (Cd)	µg/L	<0.1	--	5	0.058 ⁽¹²⁾	0.1 ⁽¹³⁾	<0.1	<0.1	<0.1	<0.1
Chromium (Cr)	µg/L	<3	50	--	8.9 ⁽¹⁴⁾	8.9 ⁽¹⁴⁾	<3	<3	<3	<3
Cobalt (Co)	µg/L	<0.5	--	--	--	0.9	<0.5	<0.5	<0.5	<0.5
Copper (Cu)	µg/L	<2	--	--	2 ⁽¹⁵⁾	5 ⁽¹⁶⁾	<2	<2	<2	<2
Iron (Fe)	µg/L	<10	--	--	300	300	72	79	160	138
Lead (Pb)	µg/L	<1	10 ⁽¹⁷⁾	--	1 ⁽¹⁸⁾	3 ⁽¹⁹⁾	<1	<1	<1	<1
Manganese (Mn)	µg/L	<2	--	--	--	--	13	17	11	8
Mercury (Hg)	µg/L	<0.10	1	--	0.026	0.2	<0.10	--	<0.10	<0.10
Molybdenum (Mo)	µg/L	<2	--	--	73	40	<2	<2	<2	<2
Nickel (Ni)	µg/L	<3	--	--	25 ⁽²⁰⁾	25	<3	<3	<3	<3
Selenium (Se)	µg/L	<4	10	--	1	100	<4	<4	<4	<4
Silver (Ag)	µg/L	<0.1	--	--	0.1	0.1	<0.1	<0.1	<0.1	<0.1
Strontium (Sr)	µg/L	<5	--	--	--	--	13	16	14	16
Thallium (Tl)	µg/L	<0.3	--	--	0.8	0.3	<0.3	<0.3	<0.3	<0.3
Titanium (Ti)	µg/L	<2	--	--	--	--	<2	<2	<2	<2
Tungsten (W)	µg/L	<10	--	--	--	30	<10	<10	<10	<10
Uranium (U)	µg/L	<2	20	--	15	5	<2	<2	<2	<2
Vanadium (V)	µg/L	<2	--	--	--	6	<2	<2	<2	<2
Zinc (Zn)	µg/L	<5	--	--	30	20	14	<5	<5	<5
Zirconium (Zr)	µg/L	<4	--	--	--	4	<4	<4	<4	<4
OTHER PARAMETERS										
Total Cyanide	µg/L	<2	--	--	--	--	<2	<2	<2	<2
Sulphur (S)	µg/L	<50	--	--	--	--	--	--	--	--
NUTRIENTS										
Nitrate (NO ₃ ⁻)	µg/L as N	<50	10000	--	13000 ⁽²¹⁾	--	--	--	--	--
Nitrite (NO ₂ ⁻)	µg/L as N	<50	1000	--	60 ⁽²²⁾	--	--	--	--	--
Total Ammonia (NH ₃ + NH ₄)	µg/L as N	<20	--	--	6980	--	<20	<20	20	30
Un-ionized Ammonia (NH ₃)	µg/L	--	--	--	15 ⁽²³⁾	20 ⁽²³⁾	<0.064	<0.22	0.068	0.0249
Total Kjeldahl Nitrogen	µg/L	<100	--	--	--	--	--	--	--	--
Total Phosphorus (P)	µg/L	<20	--	--	20	20	20	<u>40</u>	<20	<20
Phosphate (PO ₄)	µg/L as P	<100	--	--	--	--	--	--	--	--
Soluble Reactive Phosphorus	µg/L	<20	--	--	--	--	--	--	--	--
ORGANICS										
Oil and Grease (Animal/Vegetable)	µg/L	<500	--	--	--	--	--	--	--	--
Oil and Grease (Mineral)	µg/L	<500	--	--	--	--	--	--	--	--
Oil and Grease (Total)	µg/L	<500	--	--	--	physically non detect	--	--	--	--
RADIONUCLIDES										
Radium-226	Bq/L	<0.001	0.6	--	--	1 ⁽²⁴⁾	--	--	<0.001	<0.001

APPENDIX A
2011-2013 Surface Water Quality Results

Parameter ⁽¹⁾	Unit	Method Detection Limit	Ontario Drinking Water Standards ⁽²⁾⁽³⁾		Canadian Water Quality Guidelines ⁽⁴⁾	Provincial Water Quality Objective ⁽⁵⁾	SR - Somme River										
			MAC	IMAC			24-Jan-12	21-Feb-12	26-Mar-12	23-May-12	20-Aug-12	19-Nov-12	17-Dec-12	29-Jan-13	24-Feb-13	19-Mar-13	24-Apr-13
FIELD PARAMETERS																	
pH	pH units	--	--	--	6.5-9	6.5-8.5	--	7.48	6.68	6.99	7.71	7.29	7.35	6.72	7.09	7.62	6.52
Temperature	degrees Celsius	--	--	--	--	-0.25	--	0.4	2.6	17.3	19	2.9	--	0.2	0.1	0.2	1.4
Conductivity	µS/cm	--	--	--	--	--	--	27.1	16.8	34.9	42.7	25.4	24.8	28	28.8	29	22.8
Dissolved Oxygen (DO)	µg/L	--	--	--	--	--	--	10290	4600	8260	7170	1212	1150	12100	12550	11680	11.5
GENERAL PARAMETERS																	
pH	pH units	--	--	--	6.5-9	6.5-8.5	6.78	6.97	6.5	6.77	6.83	6.63	6.51	6.52	6.54	6.49	6.44
Alkalinity	µg/L as CaCO3	<5000	--	--	--	-25%	15000	17000	8000	13000	16000	13000	13000	16000	18000	21000	12000
Acidity	µg/L as CaCO3	<5000	--	--	--	--	--	--	--	--	--	--	--	--	--	--	--
Electrical Conductivity (EC)	µS/cm	<2	--	--	--	--	51	52	30	41	49	42	43	52	54	56	41
Total Dissolved Solids (TDS)	µg/L	<20000	--	--	--	--	34000	32000	58000	28000	50000	56000	58000	88000	28000	48000	46000
Total Suspended Solids (TSS)	µg/L	<1000, <10000	--	--	+5000-25000 ⁽⁶⁾	--	<10000	<10000	<10000	<10000	<10000	1000	1000	<1000	<1000	<1000	<1000
Total Hardness	µg/L as CaCO3	<500	--	--	--	--	24100	23300	13800	18900	22400	--	23800	--	--	--	21100
Dissolved Organic Carbon (DOC)	µg/L	<500	--	--	--	--	11300	11800	10600	8700	6500	11500	13100	11000	10000	8600	12500
Total Organic Carbon (TOC)	µg/L	<500	--	--	--	--	--	--	--	--	--	--	--	--	--	--	--
Chemical Oxygen Demand (COD)	µg/L	<5000	--	--	--	--	--	--	--	--	--	--	--	--	--	--	--
MAJOR IONS																	
Calcium (Ca)	µg/L	<50	--	--	--	--	6740	6580	3820	5280	6240	6020	6560	6660	7230	6820	5880
Magnesium (Mg)	µg/L	<50	--	--	--	--	1760	1680	1040	1380	1650	1460	1810	1790	1900	1780	1550
Potassium (K)	µg/L	<50	--	--	--	--	370	350	290	320	390	360	250	300	360	330	370
Sodium (Na)	µg/L	<50	--	--	--	--	1030	980	680	880	970	1130	1030	1020	1070	1000	890
Chloride (Cl)	µg/L	<100	--	--	--	--	390	480	330	330	430	410	480	470	430	430	350
Fluoride (F)	µg/L	<50	1500 ⁽⁷⁾	--	--	--	<50	<50	<50	60	<50	<50	<50	<50	<50	<50	<50
Sulphate (SO ₄)	µg/L	<100	--	--	--	--	3970	4020	3230	3250	3190	3000	3270	3760	3640	3570	2990
METALS																	
Aluminum (Al)	µg/L	<4	--	--	100 ⁽⁸⁾	75 ⁽⁹⁾	54	43	110	37	10	57	93	79	57	43	91
Antimony (Sb)	µg/L	<6	--	6	--	20	<6	<6	<6	<6	<6	<6	<6	<6	<6	<6	<6
Arsenic (As)	µg/L	<3	--	25	5	5	<3	<3	<3	<3	<3	<3	<3	<3	<3	<3	<3
Barium (Ba)	µg/L	<2	1000	--	--	--	5	4	3	4	3	3	4	5	5	6	5
Beryllium (Be)	µg/L	<1	--	--	--	11 ⁽¹⁰⁾	<1	<1	<1	<1	<1	<1	<1	<1	<1	<1	<1
Boron (B)	µg/L	<10	--	5000	1500 ⁽¹¹⁾	200	<10	<10	<10	<10	<10	<10	<10	<10	<10	<10	<10
Cadmium (Cd)	µg/L	<0.1	--	5	0.058 ⁽¹²⁾	0.1 ⁽¹³⁾	<0.1	<0.1	<0.1	<0.1	<0.1	<0.1	<0.1	<0.1	<0.1	<0.1	<0.1
Chromium (Cr)	µg/L	<3	50	--	8.9 ⁽¹⁴⁾	8.9 ⁽¹⁴⁾	<3	<3	<3	<3	<3	<3	<3	<3	<3	<3	<3
Cobalt (Co)	µg/L	<0.5	--	--	--	0.9	<0.5	<0.5	<0.5	<0.5	<0.5	<0.5	<0.5	<0.5	<0.5	<0.5	<0.5
Copper (Cu)	µg/L	<2	--	--	2 ⁽¹⁵⁾	5 ⁽¹⁶⁾	<2	<2	<2	<2	<2	<2	<2	<2	<2	<2	<2
Iron (Fe)	µg/L	<10	--	--	300	300	160	134	197	90	51	178	191	170	178	151	208
Lead (Pb)	µg/L	<1	10 ⁽¹⁷⁾	--	1 ⁽¹⁸⁾	3 ⁽¹⁹⁾	<1	<1	<1	<1	<1	<1	<1	<1	<1	<1	<1
Manganese (Mn)	µg/L	<2	--	--	--	--	13	11	23	15	19	10	9	10	11	17	29
Mercury (Hg)	µg/L	<0.10	1	--	0.026	0.2	<0.10	<0.10	<0.10	<0.10	--	<0.10	<0.10	<0.10	<0.10	<0.10	<0.10
Molybdenum (Mo)	µg/L	<2	--	--	73	40	<2	<2	<2	<2	<2	<2	<2	<2	<2	<2	<2
Nickel (Ni)	µg/L	<3	--	--	25 ⁽²⁰⁾	25	<3	<3	<3	<3	<3	<3	<3	<3	<3	<3	<3
Selenium (Se)	µg/L	<4	10	--	1	100	<4	<4	<4	<4	<4	<4	<4	<4	<4	<4	<4
Silver (Ag)	µg/L	<0.1	--	--	0.1	0.1	<0.1	<0.1	<0.1	<0.1	<0.1	<0.1	<0.1	<0.1	<0.1	<0.1	<0.1
Strontium (Sr)	µg/L	<5	--	--	--	--	20	16	10	13	18	14	16	18	17	18	14
Thallium (Tl)	µg/L	<0.3	--	--	0.8	0.3	<0.3	<0.3	<0.3	<0.3	<0.3	<0.3	<0.3	<0.3	<0.3	<0.3	<0.3
Titanium (Ti)	µg/L	<2	--	--	--	--	<2	<2	<2	<2	<2	<2	<2	<2	<2	<2	<2
Tungsten (W)	µg/L	<10	--	--	--	30	<10	<10	<10	<10	<10	<10	<10	<10	<10	<10	<10
Uranium (U)	µg/L	<2	20	--	15	5	<2	<2	<2	<2	<2	<2	<2	<2	<2	<2	<2
Vanadium (V)	µg/L	<2	--	--	--	6	<2	<2	<2	<2	<2	<2	<2	<2	<2	<2	<2
Zinc (Zn)	µg/L	<5	--	--	30	20	200	<5	7	<5	5	<5	<5	<5	18	<5	<5
Zirconium (Zr)	µg/L	<4	--	--	--	4	<4	<4	<4	<4	<4	<4	<4	<4	<4	<4	<4
OTHER PARAMETERS																	
Total Cyanide	µg/L	<2	--	--	--	--	3	<2	<2	<2	<2	<2	<2	<2	<2	<2	<2
Sulphur (S)	µg/L	<50	--	--	--	--	--	--	--	--	--	--	--	--	--	--	--
NUTRIENTS																	
Nitrate (NO ₃ ⁻)	µg/L as N	<50	10000	--	13000 ⁽²¹⁾	--	--	--	--	--	--	--	--	--	--	--	--
Nitrite (NO ₂ ⁻)	µg/L as N	<50	1000	--	60 ⁽²²⁾	--	--	--	--	--	--	--	--	--	--	--	--
Total Ammonia (NH ₃ + NH ₄)	µg/L as N	<20	--	--	6980	--	<20	<20	<20	<20	<20	<20	20	40	40	30	30
Un-ionized Ammonia (NH ₃)	µg/L	--	--	--	19 ⁽²³⁾	20 ⁽²³⁾	--	<0.052	<0.0068	<0.064	<0.24	<0.068	--	0.0104	0.0332	0.078	--
Total Kjeldahl Nitrogen	µg/L	<100	--	--	--	--	--	--	--	--	--	--	--	--	--	--	--
Total Phosphorus (P)	µg/L	<20	--	--	20	20	20	<20	<20	20	40	<20	<20	<20	<20	<20	<20
Phosphate (PO ₄)	µg/L as P	<100	--	--	--	--	--	--	--	--	--	<100	--	--	--	--	<100
Soluble Reactive Phosphorus	µg/L	<20	--	--	--	--	--	--	--	--	--	--	--	--	--	--	--
ORGANICS																	
Oil and Grease (Animal/Vegetable)	µg/L	<500	--	--	--	--	--	--	--	--	--	--	--	--	--	--	--
Oil and Grease (Mineral)	µg/L	<500	--	--	--	--	--	--	--	--	--	--	--	--	--	--	--
Oil and Grease (Total)	µg/L	<500	--	--	--	physically non detect	--	--	--	--	--	--	--	--	--	--	--
RADIONUCLIDES																	
Radium-226	Bq/L	<0.001	0.6	--	--	1 ⁽²⁴⁾	--	--	--	--	--	<0.001	<0.001	<0.001	<0.001	<0.001	--

APPENDIX A
2011-2013 Surface Water Quality Results

Parameter ⁽¹⁾	Unit	Method Detection Limit	Ontario Drinking Water Standards ⁽²⁾⁽³⁾		Canadian Water Quality Guidelines ⁽⁴⁾	Provincial Water Quality Objective ⁽⁵⁾	NL - Neville Lake			
			MAC	IMAC			29-Jan-13	24-Feb-13	19-Mar-13	20-May-13
FIELD PARAMETERS										
pH	pH units	--	--	--	6.5-9	6.5-8.5	6.76	7.25	7.06	6.55
Temperature	degrees Celsius	--	--	--	--	-0.25	0.3	0.1	0.3	10.5
Conductivity	µS/cm	--	--	--	--	--	28	31.3	3	22.5
Dissolved Oxygen (DO)	µg/L	--	--	--	--	--	12630	11250	11160	1118
GENERAL PARAMETERS										
pH	pH units	--	--	--	6.5-9	6.5-8.5	6.53	6.49	6.56	6.14
Alkalinity	µg/L as CaCO ₃	<5000	--	--	--	-25%	16000	21000	20000	8000
Acidity	µg/L as CaCO ₃	<5000	--	--	--	--	--	--	--	--
Electrical Conductivity (EC)	µS/cm	<2	--	--	--	--	51	59	58	32
Total Dissolved Solids (TDS)	µg/L	<20000	--	--	--	--	52000	42000	34000	44000
Total Suspended Solids (TSS)	µg/L	<1000, <10000	--	--	+5000-25000 ⁽⁶⁾	--	<1000	<1000	<1000	1000
Total Hardness	µg/L as CaCO ₃	<500	--	--	--	--	23600	28100	25900	15900
Dissolved Organic Carbon (DOC)	µg/L	<500	--	--	--	--	11900	10700	10000	11600
Total Organic Carbon (TOC)	µg/L	<500	--	--	--	--	--	--	--	--
Chemical Oxygen Demand (COD)	µg/L	<5000	--	--	--	--	--	--	--	--
MAJOR IONS										
Calcium (Ca)	µg/L	<50	--	--	--	--	6650	8380	7400	4530
Magnesium (Mg)	µg/L	<50	--	--	--	--	1690	1740	1800	1110
Potassium (K)	µg/L	<50	--	--	--	--	240	340	330	300
Sodium (Na)	µg/L	<50	--	--	--	--	970	960	1000	710
Chloride (Cl)	µg/L	<100	--	--	--	--	460	380	390	200
Fluoride (F)	µg/L	<50	150 ⁽⁷⁾	--	--	--	<50	<50	<50	<50
Sulphate (SO ₄)	µg/L	<100	--	--	--	--	3710	3330	3510	2800
METALS										
Aluminum (Al)	µg/L	<4	--	--	100 ⁽⁸⁾	75 ⁽⁹⁾	90	51	64	87
Antimony (Sb)	µg/L	<6	--	6	--	20	<6	<6	<6	<6
Arsenic (As)	µg/L	<3	--	25	5	5	<3	<3	<3	<3
Barium (Ba)	µg/L	<2	1000	--	--	--	5	5	6	4
Beryllium (Be)	µg/L	<1	--	--	--	11 ⁽¹⁰⁾	<1	<1	<1	<1
Boron (B)	µg/L	<10	--	5000	1500 ⁽¹¹⁾	200	<10	<10	<10	<10
Cadmium (Cd)	µg/L	<0.1	--	5	0.058 ⁽¹²⁾	0.1 ⁽¹³⁾	<0.1	<0.1	<0.1	<0.1
Chromium (Cr)	µg/L	<3	50	--	8.9 ⁽¹⁴⁾	8.9 ⁽¹⁴⁾	<3	<3	<3	<3
Cobalt (Co)	µg/L	<0.5	--	--	--	0.9	<0.5	<0.5	<0.5	<0.5
Copper (Cu)	µg/L	<2	--	--	2 ⁽¹⁵⁾	5 ⁽¹⁶⁾	<2	<2	<2	<2
Iron (Fe)	µg/L	<10	--	--	300	300	234	169	145	133
Lead (Pb)	µg/L	<1	10 ⁽¹⁷⁾	--	1 ⁽¹⁸⁾	3 ⁽¹⁹⁾	<1	<1	<1	<1
Manganese (Mn)	µg/L	<2	--	--	--	--	11	13	16	13
Mercury (Hg)	µg/L	<0.10	1	--	0.026	0.2	<0.10	<0.10	<0.10	<0.10
Molybdenum (Mo)	µg/L	<2	--	--	73	40	<2	<2	<2	<2
Nickel (Ni)	µg/L	<3	--	--	25 ⁽²⁰⁾	25	<3	<3	<3	<3
Selenium (Se)	µg/L	<4	10	--	1	100	<4	<4	<4	<4
Silver (Ag)	µg/L	<0.1	--	--	0.1	0.1	<0.1	<0.1	<0.1	<0.1
Strontium (Sr)	µg/L	<5	--	--	--	--	20	19	23	13
Thallium (Tl)	µg/L	<0.3	--	--	0.8	0.3	<0.3	<0.3	<0.3	<0.3
Titanium (Ti)	µg/L	<2	--	--	--	--	2	<2	<2	<2
Tungsten (W)	µg/L	<10	--	--	--	30	<10	<10	<10	<10
Uranium (U)	µg/L	<2	20	--	15	5	<2	<2	<2	<2
Vanadium (V)	µg/L	<2	--	--	--	6	<2	<2	<2	<2
Zinc (Zn)	µg/L	<5	--	--	30	20	<5	<5	64	<5
Zirconium (Zr)	µg/L	<4	--	--	--	4	<4	<4	<4	<4
OTHER PARAMETERS										
Total Cyanide	µg/L	<2	--	--	--	--	<2	<2	<2	<2
Sulphur (S)	µg/L	<50	--	--	--	--	--	--	--	--
NUTRIENTS										
Nitrate (NO ₃ ⁻)	µg/L as N	<50	10000	--	13000 ⁽²¹⁾	--	--	--	--	--
Nitrite (NO ₂ ⁻)	µg/L as N	<50	1000	--	60 ⁽²²⁾	--	--	--	--	--
Total Ammonia (NH ₃ + NH ₄)	µg/L as N	<20	--	--	6980	--	50	100	70	<20
Un-ionized Ammonia (NH ₃)	µg/L	--	--	--	19 ⁽²³⁾	20 ⁽²³⁾	0.0415	0.26	0.0581	--
Total Kjeldahl Nitrogen	µg/L	<100	--	--	--	--	--	--	--	--
Total Phosphorus (P)	µg/L	<20	--	--	20	20	<20	<20	<20	<20
Phosphate (PO ₄)	µg/L as P	<100	--	--	--	--	--	--	--	<10
Soluble Reactive Phosphorus	µg/L	<20	--	--	--	--	--	--	--	--
ORGANICS										
Oil and Grease (Animal/Vegetable)	µg/L	<500	--	--	--	--	--	--	--	--
Oil and Grease (Mineral)	µg/L	<500	--	--	--	--	--	--	--	--
Oil and Grease (Total)	µg/L	<500	--	--	--	physically non detect	--	--	--	--
RADIONUCLIDES										
Radium-226	Bq/L	<0.001	0.6	--	--	1 ⁽²⁴⁾	<0.001	<0.001	<0.001	<0.001

APPENDIX A
2011-2013 Surface Water Quality Results

Parameter ⁽¹⁾	Unit	Method Detection Limit	Ontario Drinking Water Standards ⁽²⁾⁽³⁾		Canadian Water Quality Guidelines ⁽⁴⁾	Provincial Water Quality Objective ⁽⁵⁾	NEV-LS - Neville Lake	
			MAC	IMAC			28-May-2013 (T)	28-May-2013 (B)
FIELD PARAMETERS								
pH	pH units	--	--	--	6.5-9	6.5-8.5	6.38	6.25
Temperature	degrees Celsius	--	--	--	--	-0.25	14.64	11.42
Conductivity	µS/cm	--	--	--	--	--	36	33
Dissolved Oxygen (DO)	µg/L	--	--	--	--	--	7780	8120
ORP	mV	--	--	--	--	--	126.8	133.2
GENERAL PARAMETERS								
pH	pH units	--	--	--	6.5-9	6.5-8.5	6.16	6.21
Alkalinity	µg/L as CaCO ₃	<5000	--	--	--	-25%	12000	10000
Acidity	µg/L as CaCO ₃	<5000	--	--	--	--	<5000	<5000
Electrical Conductivity (EC)	µS/cm	<2	--	--	--	--	40	37
Total Dissolved Solids (TDS)	µg/L	<20000	--	--	--	--	104000	152000
Total Suspended Solids (TSS)	µg/L	<1000, <10000	--	--	+5000-25000 ⁽⁶⁾	--	<10000	<10000
Total Hardness	µg/L as CaCO ₃	<500	--	--	--	--	19900	17800
Dissolved Organic Carbon (DOC)	µg/L	<500	--	--	--	--	12600	12300
Total Organic Carbon (TOC)	µg/L	<500	--	--	--	--	13200	13200
Chemical Oxygen Demand (COD)	µg/L	<5000	--	--	--	--	--	--
MAJOR IONS								
Calcium (Ca)	µg/L	<50	--	--	--	--	6070	5440
Magnesium (Mg)	µg/L	<50	--	--	--	--	1160	1030
Potassium (K)	µg/L	<50	--	--	--	--	250	240
Sodium (Na)	µg/L	<50	--	--	--	--	770	730
Chloride (Cl)	µg/L	<100	--	--	--	--	260	270
Fluoride (F)	µg/L	<50	1500 ⁽⁷⁾	--	--	--	<50	<50
Sulphate (SO ₄)	µg/L	<100	--	--	--	--	2640	2680
METALS								
Aluminum (Al)	µg/L	<4	--	--	100 ⁽⁸⁾	75 ⁽⁹⁾	79	88
Antimony (Sb)	µg/L	<6	--	6	--	20	<3	<3
Arsenic (As)	µg/L	<3	--	25	5	5	<3	<3
Barium (Ba)	µg/L	<2	1000	--	--	--	4	4
Beryllium (Be)	µg/L	<1	--	--	--	11 ⁽¹⁰⁾	<1	<1
Boron (B)	µg/L	<10	--	5000	1500 ⁽¹¹⁾	200	<10	<10
Cadmium (Cd)	µg/L	<0.1	--	5	0.058 ⁽¹²⁾	0.1 ⁽¹³⁾	<0.1	<0.1
Chromium (Cr)	µg/L	<3	50	--	8.9 ⁽¹⁴⁾	8.9 ⁽¹⁴⁾	<3	<3
Cobalt (Co)	µg/L	<0.5	--	--	--	0.9	<0.5	<0.5
Copper (Cu)	µg/L	<2	--	--	2 ⁽¹⁵⁾	5 ⁽¹⁶⁾	<2	<2
Iron (Fe)	µg/L	<10	--	--	300	300	90	250
Lead (Pb)	µg/L	<1	10 ⁽¹⁷⁾	--	1 ⁽¹⁸⁾	3 ⁽¹⁹⁾	<1	<1
Manganese (Mn)	µg/L	<2	--	--	--	--	14	36
Mercury (Hg)	µg/L	<0.10	1	--	0.026	0.2	<0.1	<0.1
Molybdenum (Mo)	µg/L	<2	--	--	73	40	<2	<2
Nickel (Ni)	µg/L	<3	--	--	25 ⁽²⁰⁾	25	<3	<3
Selenium (Se)	µg/L	<4	10	--	1	100	<4	<4
Silver (Ag)	µg/L	<0.1	--	--	0.1	0.1	<0.1	<0.1
Strontium (Sr)	µg/L	<5	--	--	--	--	17	13
Thallium (Tl)	µg/L	<0.3	--	--	0.8	0.3	<0.3	<0.3
Titanium (Ti)	µg/L	<2	--	--	--	--	<2	<2
Tungsten (W)	µg/L	<10	--	--	--	30	<10	<10
Uranium (U)	µg/L	<2	20	--	15	5	<2	<2
Vanadium (V)	µg/L	<2	--	--	--	6	<2	<2
Zinc (Zn)	µg/L	<5	--	--	30	20	16	18
Zirconium (Zr)	µg/L	<4	--	--	--	4	<4	<4
OTHER PARAMETERS								
Total Cyanide	µg/L	<2	--	--	--	--	<2	<2
Total Cyanide	µg/L	<2	--	--	--	5	<2	<2
Free Cyanide	µg/L	<2	--	--	--	5	<2	<2
Sulphur (S)	µg/L	<50	--	--	--	--	--	--
Total Ammonia (NH₃ + NH₄)								
Nitrate (NO ₃ ⁻)	µg/L as N	<50	10000	--	13000 ⁽²¹⁾	--	<50	80
Nitrite (NO ₂ ⁻)	µg/L as N	<50	1000	--	60 ⁽²²⁾	--	<50	<50
Total Phosphorus (P)	µg/L as N	<20	--	--	6980	--	<20	70
Un-ionized Ammonia (NH ₃)	µg/L	--	--	--	19 ⁽²³⁾	20 ⁽²³⁾	<0.013	0.026
Total Kjeldahl Nitrogen	µg/L	<100	--	--	--	--	--	--
Total Phosphorus (TP)	µg/L	<20	--	--	20	20	<20	<20
Phosphate (PO ₄)	µg/L as P	<100	--	--	--	--	--	--
Soluble Reactive Phosphorus	µg/L	<20	--	--	--	--	--	--
ORGANICS								
Oil and Grease (Animal/Vegetable)	µg/L	<500	--	--	--	--	--	--
Oil and Grease (Mineral)	µg/L	<500	--	--	--	--	--	--
Oil and Grease (Total)	µg/L	<500	--	--	--	physically non detect	--	--
Polychlorinated Biphenyls	µg/L	<0.1	--	0.003	--	0.001	--	--
Naphthalene	µg/L	<0.2	--	--	1.1	7	--	--
Acenaphthylene	µg/L	<0.2	--	--	--	--	--	--
Acenaphthene	µg/L	<0.2	--	--	5.8	--	--	--
Fluorene	µg/L	<0.2	--	--	3	0.2	--	--
Phenanthrene	µg/L	<0.1	--	--	0.4	0.03	--	--
Anthracene	µg/L	<0.1	--	--	0.012	0.0008	--	--
Fluoranthene	µg/L	<0.2	--	--	0.04	0.0008	--	--
Pyrene	µg/L	<0.2	--	--	0.025	--	--	--
Benz(a)anthracene	µg/L	<0.2	--	--	0.018	0.0004	--	--
Chrysene	µg/L	<0.1	--	--	--	0.0001	--	--
Benzo(b)fluoranthene	µg/L	<0.1	--	--	--	--	--	--
Benzo(k)fluoranthene	µg/L	<0.1	--	--	--	0.0002	--	--
Benzo(a)pyrene	µg/L	<0.01	--	--	0.015	--	--	--
Indeno(1,2,3-cd)pyrene	µg/L	<0.2	--	--	--	--	--	--
Dibenz(a,h)anthracene	µg/L	<0.2	--	--	--	0.002	--	--
Benzo(g,h,i)perylene	µg/L	<0.2	--	--	--	0.00002	--	--
2-and 1-methyl Naphthalene	µg/L	<0.2	--	--	--	--	--	--
RADIONUCLIDES								
Radium-226	Bq/L	<0.001	0.6	--	--	1 ⁽²⁴⁾	--	--
MICROBIOLOGICAL								
Escherichia coli	CFU/100mL	1	--	--	--	100	--	--
Total Coliforms	CFU/100mL	1	--	--	--	--	--	--

APPENDIX A
2011-2013 Surface Water Quality Results

Parameter ⁽¹⁾	Unit	Method Detection Limit	Ontario Drinking Water Standards ⁽²⁾⁽³⁾		Canadian Water Quality Guidelines ⁽⁴⁾	Provincial Water Quality Objective ⁽⁵⁾	MESO-OUT - Mesomikenda Lake Outflow			
			MAC	IMAC			29-Jan-13	24-Feb-13	19-Mar-13	24-Apr-13
FIELD PARAMETERS										
pH	pH units	--	--	--	6.5-9	6.5-8.5	7.9	8.03	7.61	--
Temperature	degrees Celsius	--	--	--	--	-0.25	-0.2	0.7	1	--
Conductivity	µS/cm	--	--	--	--	--	34.1	33.9	34	--
Dissolved Oxygen (DO)	µg/L	--	--	--	--	--	8850	13300	12790	--
GENERAL PARAMETERS										
pH	pH units	--	--	--	6.5-9	6.5-8.5	6.66	6.63	6.71	6.44
Alkalinity	µg/L as CaCO ₃	<5000	--	--	--	-25%	21000	23000	22000	18000
Acidity	µg/L as CaCO ₃	<5000	--	--	--	--	--	--	--	--
Electrical Conductivity (EC)	µS/cm	<2	--	--	--	--	60	62	64	58
Total Dissolved Solids (TDS)	µg/L	<20000	--	--	--	--	90000	34000	52000	20000
Total Suspended Solids (TSS)	µg/L	<1000, <10000	--	--	+5000-25000 ⁽⁶⁾	--	<1000	<1000	1000	<1000
Total Hardness	µg/L as CaCO ₃	<500	--	--	--	--	28800	29100	28300	28300
Dissolved Organic Carbon (DOC)	µg/L	<500	--	--	--	--	14500	9500	9800	8400
Total Organic Carbon (TOC)	µg/L	<500	--	--	--	--	--	--	--	--
Chemical Oxygen Demand (COD)	µg/L	<5000	--	--	--	--	--	--	--	--
MAJOR IONS										
Calcium (Ca)	µg/L	<50	--	--	--	--	8220	8420	8160	8310
Magnesium (Mg)	µg/L	<50	--	--	--	--	2020	1960	1920	1840
Potassium (K)	µg/L	<50	--	--	--	--	370	310	320	420
Sodium (Na)	µg/L	<50	--	--	--	--	1320	1230	1330	1470
Chloride (Cl)	µg/L	<100	--	--	--	--	710	770	1070	1310
Fluoride (F)	µg/L	<50	1500 ⁽⁷⁾	--	--	--	<50	<50	<50	<50
Sulphate (SO ₄)	µg/L	<100	--	--	--	--	4060	3660	3340	3180
METALS										
Aluminum (Al)	µg/L	<4	--	--	100 ⁽⁸⁾	75 ⁽⁹⁾	91	48	45	48
Antimony (Sb)	µg/L	<6	--	6	--	20	<6	<6	<6	<6
Arsenic (As)	µg/L	<3	--	25	5	5	<3	<3	<3	<3
Barium (Ba)	µg/L	<2	1000	--	--	--	5	4	5	4
Beryllium (Be)	µg/L	<1	--	--	--	11 ⁽¹⁰⁾	<1	<1	<1	<1
Boron (B)	µg/L	<10	--	5000	1500 ⁽¹¹⁾	200	<10	<10	<10	<10
Cadmium (Cd)	µg/L	<0.1	--	5	0.058 ⁽¹²⁾	0.1 ⁽¹³⁾	<0.1	<0.1	<0.1	<0.1
Chromium (Cr)	µg/L	<3	50	--	8.9 ⁽¹⁴⁾	8.9 ⁽¹⁴⁾	<3	<3	<3	<3
Cobalt (Co)	µg/L	<0.5	--	--	--	0.9	<0.5	<0.5	<0.5	<0.5
Copper (Cu)	µg/L	<2	--	--	2 ⁽¹⁵⁾	5 ⁽¹⁶⁾	<2	<2	<2	<2
Iron (Fe)	µg/L	<10	--	--	300	300	172	109	60	46
Lead (Pb)	µg/L	<1	10 ⁽¹⁷⁾	--	1 ⁽¹⁸⁾	3 ⁽¹⁹⁾	<1	<1	<1	<1
Manganese (Mn)	µg/L	<2	--	--	--	--	11	6	6	9
Mercury (Hg)	µg/L	<0.10	1	--	0.026	0.2	<0.10	<0.10	<0.10	<0.10
Molybdenum (Mo)	µg/L	<2	--	--	73	40	<2	<2	<2	<2
Nickel (Ni)	µg/L	<3	--	--	25 ⁽²⁰⁾	25	<3	<3	<3	<3
Selenium (Se)	µg/L	<4	10	--	1	100	<4	<4	<4	<4
Silver (Ag)	µg/L	<0.1	--	--	0.1	0.1	<0.1	<0.1	<0.1	<0.1
Strontium (Sr)	µg/L	<5	--	--	--	--	21	17	18	16
Thallium (Tl)	µg/L	<0.3	--	--	0.8	0.3	<0.3	<0.3	<0.3	<0.3
Titanium (Ti)	µg/L	<2	--	--	--	--	<2	<2	<2	<2
Tungsten (W)	µg/L	<10	--	--	--	30	<10	<10	<10	<10
Uranium (U)	µg/L	<2	20	--	15	5	<2	<2	<2	<2
Vanadium (V)	µg/L	<2	--	--	--	6	<2	<2	<2	<2
Zinc (Zn)	µg/L	<5	--	--	30	20	12	<5	<5	<5
Zirconium (Zr)	µg/L	<4	--	--	--	4	<4	<4	<4	<4
OTHER PARAMETERS										
Total Cyanide	µg/L	<2	--	--	--	--	<2	<2	<2	<2
Sulphur (S)	µg/L	<50	--	--	--	--	--	--	--	--
NUTRIENTS										
Nitrate (NO ₃ ⁻)	µg/L as N	<50	10000	--	13000 ⁽²¹⁾	--	--	--	--	--
Nitrite (NO ₂ ⁻)	µg/L as N	<50	1000	--	60 ⁽²²⁾	--	--	--	--	--
Total Ammonia (NH ₃ + NH ₄)	µg/L as N	<20	--	--	6980	--	60	40	30	<20
Un-ionized Ammonia (NH ₃)	µg/L	--	--	--	19 ⁽²³⁾	20 ⁽²³⁾	0.492	0.356	0.084	--
Total Kjeldahl Nitrogen	µg/L	<100	--	--	--	--	--	--	--	--
Total Phosphorus (P)	µg/L	<20	--	--	20	20	20	<20	<20	<20
Phosphate (PO ₄)	µg/L as P	<100	--	--	--	--	--	--	--	<10
Soluble Reactive Phosphorus	µg/L	<20	--	--	--	--	--	--	--	--
ORGANICS										
Oil and Grease (Animal/Vegetable)	µg/L	<500	--	--	--	--	--	--	--	--
Oil and Grease (Mineral)	µg/L	<500	--	--	--	--	--	--	--	--
Oil and Grease (Total)	µg/L	<500	--	--	--	physically non detect	--	--	--	--
RADIONUCLIDES										
Radium-226	Bq/L	<0.001	0.6	--	--	1 ⁽²⁴⁾	<0.001	<0.001	<0.001	<0.001

APPENDIX A
2011-2013 Surface Water Quality Results

Parameter ⁽¹⁾	Unit	Method Detection Limit	Ontario Drinking Water Standards ⁽²⁾⁽³⁾		Canadian Water Quality Guidelines ⁽⁴⁾	Provincial Water Quality Objective ⁽⁵⁾	MESO-LS2 - Mesonikenda Lake (Upper)			MESO-LS4 - Mesonikenda Lake (Middle)		MESO-LS5 - Mesonikenda Lake (Middle)		MESO-LS7 - Mesonikenda Lake (Lower)	
			MAC	IMAC			28-May-2013 (T)	28-May-2013 (T Dup)	28-May-2013 (B)	30-May-2013 (T)	30-May-2013 (B)	30-May-2013 (T)	30-May-2013 (B)	29-May-2013 (T)	29-May-2013 (B)
FIELD PARAMETERS															
pH	pH units	--	--	--	6.5-9	6.5-8.5	7.04	7.04	7.01	7.23	7.06	7.3	7.17	7.43	7.25
Temperature	degrees Celsius	--	--	--	--	-0.25	9.77	9.77	7.97	11.58	4.99	11.02	7.88	11.02	7.76
Conductivity	µS/cm	--	--	--	--	--	50	50	56	73	75	74	90	127	128
Dissolved Oxygen (DO)	µg/L	--	--	--	--	--	10870	10870	10990	11800	11630	11990	12670	13790	13510
ORP	mV	--	--	--	--	--	113.8	113.8	101.7	74.2	69.4	52.7	7	100.7	96.3
GENERAL PARAMETERS															
pH	pH units	--	--	--	6.5-9	6.5-8.5	6.36	6.35	6.36	6.32	6.32	6.54	6.34	6.81	6.35
Alkalinity	µg/L as CaCO3	<5000	--	--	--	-25%	18000	20000	21000	21000	23000	23000	23000	29000	32000
Acidity	µg/L as CaCO3	<5000	--	--	--	--	<5000	<5000	<5000	<5000	<5000	<5000	<5000	<5000	<5000
Electrical Conductivity (EC)	µS/cm	<2	--	--	--	--	56	56	62	80	83	83	83	130	128
Total Dissolved Solids (TDS)	µg/L	<20000	--	--	--	--	56000	84000	64000	82000	92000	60000	52000	76000	86000
Total Suspended Solids (TSS)	µg/L	<1000, <10000	--	--	+5000-25000 ⁽⁶⁾	--	<10000	<10000	<10000	<10000	<10000	<10000	<10000	<10000	<10000
Total Hardness	µg/L as CaCO3	<500	--	--	--	--	25600	24700	26500	28100	29900	29100	29800	38400	45500
Dissolved Organic Carbon (DOC)	µg/L	<500	--	--	--	--	7900	7800	7700	8400	8900	8600	8300	6700	5900
Total Organic Carbon (TOC)	µg/L	<500	--	--	--	--	8500	8500	7700	9000	8800	9000	8000	6600	6100
Chemical Oxygen Demand (COD)	µg/L	<5000	--	--	--	--	--	--	--	--	--	--	--	--	--
MAJOR IONS															
Calcium (Ca)	µg/L	<50	--	--	--	--	7530	7300	7870	8400	9000	8720	8930	12000	14200
Magnesium (Mg)	µg/L	<50	--	--	--	--	1640	1570	1670	1720	1810	1790	1830	2040	2440
Potassium (K)	µg/L	<50	--	--	--	--	360	330	330	410	430	430	400	470	530
Sodium (Na)	µg/L	<50	--	--	--	--	1370	1340	1590	1400	4270	4330	4250	8690	9620
Chloride (Cl)	µg/L	<100	--	--	--	--	1140	1120	1560	7200	7440	7470	7460	15800	16000
Fluoride (F)	µg/L	<50	1500 ⁽⁷⁾	--	--	--	<50	<50	<50	<50	<50	<50	<50	<50	<50
Sulphate (SO ₄)	µg/L	<100	3300	--	--	--	3240	3300	3440	4130	4230	4110	4660	4310	4310
METALS															
Aluminum (Al)	µg/L	<4	--	--	100 ⁽⁸⁾	75 ⁽⁹⁾	57	54	45	54	89	44	43	29	33
Antimony (Sb)	µg/L	<6	--	6	--	20	<3	<3	<3	<3	<3	<3	<3	<3	<3
Arsenic (As)	µg/L	<3	--	25	5	5	<3	<3	<3	<3	<3	<3	<3	<3	<3
Barium (Ba)	µg/L	<2	1000	--	--	--	4	4	3	3	4	3	3	3	3
Beryllium (Be)	µg/L	<1	--	--	--	11 ⁽¹⁰⁾	<1	<1	<1	<1	<1	<1	<1	<1	<1
Boron (B)	µg/L	<10	--	5000	1500 ⁽¹¹⁾	200	<10	<10	<10	<10	<10	<10	<10	<10	<10
Cadmium (Cd)	µg/L	<0.1	--	5	0.058 ⁽¹²⁾	0.1 ⁽¹³⁾	<0.1	<0.1	<0.1	<0.1	<0.1	<0.1	<0.1	<0.1	<0.1
Chromium (Cr)	µg/L	<3	50	--	8.9 ⁽¹⁴⁾	8.9 ⁽¹⁴⁾	<3	<3	<3	<3	<3	<3	<3	<3	<3
Cobalt (Co)	µg/L	<0.5	--	--	--	0.9	<0.5	<0.5	<0.5	<0.5	<0.5	<0.5	<0.5	<0.5	<0.5
Copper (Cu)	µg/L	<2	--	--	2 ⁽¹⁵⁾	5 ⁽¹⁶⁾	<2	<2	<2	<2	<2	<2	<2	<2	<2
Iron (Fe)	µg/L	<10	--	--	300	300	20	30	<10	<10	<10	20	20	<10	30
Lead (Pb)	µg/L	<1	10 ⁽¹⁷⁾	--	1 ⁽¹⁸⁾	3 ⁽¹⁹⁾	<1	<1	<1	<1	<1	<1	<1	<1	<1
Manganese (Mn)	µg/L	<2	--	--	--	--	8	10	10	3	3	5	5	6	11
Mercury (Hg)	µg/L	<0.10	1	--	0.026	0.2	<0.1	<0.1	<0.1	<0.1	<0.1	<0.1	<0.1	<0.1	<0.1
Molybdenum (Mo)	µg/L	<2	--	--	73	40	<2	<2	<2	<2	<2	<2	<2	<2	<2
Nickel (Ni)	µg/L	<3	--	--	25 ⁽²⁰⁾	25	<3	<3	<3	<3	<3	<3	<3	<3	<3
Selenium (Se)	µg/L	<4	10	--	1	100	<4	<4	<4	<4	<4	<4	<4	<4	<4
Silver (Ag)	µg/L	<0.1	--	--	0.1	0.1	<0.1	<0.1	<0.1	<0.1	<0.1	<0.1	<0.1	<0.1	<0.1
Strontium (Sr)	µg/L	<5	--	--	--	--	15	18	17	17	21	17	17	18	20
Thallium (Tl)	µg/L	<0.3	--	--	0.8	0.3	<0.3	<0.3	<0.3	<0.3	<0.3	<0.3	<0.3	<0.3	<0.3
Titanium (Ti)	µg/L	<2	--	--	--	--	<2	<2	<2	<2	<2	<2	<2	<2	<2
Tungsten (W)	µg/L	<10	--	--	30	30	<10	<10	<10	<10	<10	<10	<10	<10	<10
Uranium (U)	µg/L	<2	20	--	15	5	<2	<2	<2	<2	<2	<2	<2	<2	<2
Vanadium (V)	µg/L	<2	--	--	6	6	<2	<2	<2	<2	<2	<2	<2	<2	<2
Zinc (Zn)	µg/L	<5	--	--	30	20	<5	48	11	18	<5	<5	<5	<5	<5
Zirconium (Zr)	µg/L	<4	--	--	--	4	<4	<4	<4	<4	<4	<4	<4	<4	<4
OTHER PARAMETERS															
Total Cyanide	µg/L	<2	--	--	--	--	<2	<2	<2	<2	<2	<2	<2	<2	<2
Free Cyanide	µg/L	<2	--	--	5	5	<2	<2	<2	<2	<2	<2	<2	<2	<2
Phenols	µg/L	<1	--	--	--	5	1	<1	--	<1	--	<1	--	--	--
Sulphur (S)	µg/L	<50	--	--	--	--	--	--	--	--	--	--	--	--	--
Total Ammonia (NH₃ + NH₄)															
Nitrate (NO ₃ ⁻)	µg/L as N	<50	10000	--	13000 ⁽²¹⁾	--	100	70	90	100	130	90	110	<50	80
Nitrite (NO ₂ ⁻)	µg/L as N	<50	1000	--	60 ⁽²²⁾	--	<50	<50	<50	<50	<50	<50	<50	<50	<50
Total Phosphorus (P)	µg/L as P	<20	--	--	6980	--	<20	<20	<20	<20	<20	30	<20	110	90
Un-ionized Ammonia (NH ₃)	µg/L	--	--	--	19 ⁽²³⁾	20 ⁽²³⁾	<0.040	<0.040	<0.032	<0.071	<0.029	0.12	<0.046	0.592	0.248
Total Kjeldahl Nitrogen	µg/L	<100	--	--	--	--	--	--	--	--	--	--	--	--	--
Total Phosphorus (TP)	µg/L	<20	--	--	20	20	<20	<20	<20	<20	<20	20	20	20	<20
Phosphate (PO ₄)	µg/L as P	<100	--	--	--	--	--	--	--	--	--	--	--	--	--
Soluble Reactive Phosphorus	µg/L	<20	--	--	--	--	--	--	--	--	--	--	--	--	--
ORGANICS															
Oil and Grease (Animal/Vegetable)	µg/L	<500	--	--	--	--	<500	<500	--	<500	--	<500	--	<500	--
Oil and Grease (Mineral)	µg/L	<500	--	--	--	--	<500	<500	--	<500	--	<500	--	<500	--
Oil and Grease (Total)	µg/L	<500	--	--	--	physically non detect	<500	<500	--	<500	--	<500	--	<500	--
Polychlorinated Biphenyls	µg/L	<0.1	--	0.003	--	0.001	<0.1	<0.1	--	<0.1	--	<0.1	--	<0.1	--
Naphthalene	µg/L	<0.2	--	--	1.1	7	<0.2	<0.2	--	<0.2	--	<0.2	--	<0.2	--
Acenaphthylene	µg/L	<0.2	--	--	--	--	<0.2	<0.2	--	<0.2	--	<0.2	--	<0.2	--
Acenaphthene	µg/L	<0.2	--	--	5.8	--	<0.2	<0.2	--	<0.2	--	<0.2	--	<0.2	--
Fluorene	µg/L	<0.2	--	--	3	0.2	<0.2	<0.2	--	<0.2	--	<0.2	--	<0.2	--
Phenanthrene	µg/L	<0.1	--	--	0.4	0.03	<0.1	<0.1	--	<0.1	--	<0.1	--	<0.1	--
Anthracene	µg/L	<0.1	--	--	0.012	0.0008	<0.1	<0.1	--	<0.1	--	<0.1	--	<0.1	--
Fluoranthene	µg/L	<0.2	--	--	0.04	0.0008	<0.2	<0.2	--	<0.2	--	<0.2	--	<0.2	--
Pyrene	µg/L	<0.2	--	--	0.025	--	<0.2	<0.2	--	<0.2	--	<0.2	--	<0.2	--
Benzo(a)anthracene	µg/L	<0.2	--	--	0.018	0.0004	<0.2	<0.2	--	<0.2	--	<0.2	--	<0.2	--
Chrysene	µg/L	<0.1	--	--	--	0.0001	<0.1	<0.1	--	<0.1	--	<0.1	--	<0.1	--
Benzo(b)fluoranthene	µg/L	<0.1	--	--	--	--	<0.1	<0.1	--	<0.1	--	<0.1	--	<0.1	--
Benzo(k)fluoranthene	µg/L	<0.1	--	--	--	0.0002	<0.1	<0.1	--	<0.1	--	<0.1	--	<0.1	--
Benzo(a)pyrene	µg/L	<0.01	--	--	0.015	--	<0.01	<0.01	--	<0.01	--	<0.01	--	<0.01	--
Indeno(1,2,3-cd)pyrene	µg/L</														

2011-2013 Surface Water Quality Results

Parameter ⁽¹⁾	Unit	Method Detection Limit	Ontario Drinking Water Standards ⁽²⁾⁽³⁾		Canadian Water Quality Guidelines ⁽⁴⁾	Provincial Water Quality Objective ⁽⁵⁾	CM-LS - Clam Lake	
			MAC	IMAC			23-May-2013 (T)	23-May-2013 (B)
FIELD PARAMETERS								
pH	pH units	--	--	--	6.5-9	6.5-8.5	7.06	7.01
Temperature	degrees Celsius	--	--	--	--	-0.25	10.79	9.29
Conductivity	µS/cm	--	--	--	--	--	38	38
Dissolved Oxygen	µg/L	--	--	--	--	--	11630	11760
ORP	mV	--	--	--	--	--	-2.2	12.6
GENERAL PARAMETERS								
pH	pH units	--	--	--	6.5-9	6.5-8.5	6.32	6.38
Alkalinity	µg/L as CaCO ₃	<5000	--	--	--	-25%	12000	12000
Acidity	µg/L as CaCO ₃	<5000	--	--	--	--	<5000	<5000
Electrical Conductivity (EC)	µS/cm	<2	--	--	--	--	42	42
Total Dissolved Solids (TDS)	µg/L	<20000	--	--	--	--	36000	40000
Total Suspended Solids (TSS)	µg/L	<1000, <10000	--	--	+5000-25000 ⁽⁶⁾	--	<10000	<10000
Total Hardness	µg/L as CaCO ₃	<500	--	--	--	--	21000	20600
Dissolved Organic Carbon (DOC)	µg/L	<500	--	--	--	--	11200	9400
Total Organic Carbon (TOC)	µg/L	<500	--	--	--	--	12700	10200
Chemical Oxygen Demand (COD)	µg/L	<5000	--	--	--	--	--	--
MAJOR IONS								
Calcium (Ca)	µg/L	<50	--	--	--	--	6800	6650
Magnesium (Mg)	µg/L	<50	--	--	--	--	980	980
Potassium (K)	µg/L	<50	--	--	--	--	440	470
Sodium (Na)	µg/L	<50	--	--	--	--	750	760
Chloride (Cl)	µg/L	<100	--	--	--	--	310	310
Fluoride (F)	µg/L	<50	1500 ⁽⁷⁾	--	--	--	<50	<50
Sulphate (SO ₄)	µg/L	<100	--	--	--	--	3580	3610
METALS								
Aluminum (Al)	µg/L	<4	--	--	100 ⁽⁸⁾	75 ⁽⁹⁾	44	164
Antimony (Sb)	µg/L	<6	--	6	--	20	<3	<3
Arsenic (As)	µg/L	<3	--	25	5	5	<3	<3
Barium (Ba)	µg/L	<2	1000	--	--	--	6	4
Beryllium (Be)	µg/L	<1	--	--	--	11 ⁽¹⁰⁾	<1	<1
Boron (B)	µg/L	<10	--	5000	1500 ⁽¹¹⁾	200	<10	<10
Cadmium (Cd)	µg/L	<0.1	--	5	0.058 ⁽¹²⁾	0.1 ⁽¹³⁾	0.1	<0.1
Chromium (Cr)	µg/L	<3	50	--	8.9 ⁽¹⁴⁾	8.9 ⁽¹⁴⁾	<3	<3
Cobalt (Co)	µg/L	<0.5	--	--	--	0.9	<0.5	<0.5
Copper (Cu)	µg/L	<2	--	--	2 ⁽¹⁵⁾	5 ⁽¹⁶⁾	2	<2
Iron (Fe)	µg/L	<10	--	--	300	300	40	40
Lead (Pb)	µg/L	<1	10 ⁽¹⁷⁾	--	1 ⁽¹⁸⁾	3 ⁽¹⁹⁾	1	<1
Manganese (Mn)	µg/L	<2	--	--	--	--	21	18
Mercury (Hg)	µg/L	<0.10	1	--	0.026	0.2	<0.10	<0.10
Molybdenum (Mo)	µg/L	<2	--	--	73	40	<2	<2
Nickel (Ni)	µg/L	<3	--	--	25 ⁽²⁰⁾	25	<3	<3
Selenium (Se)	µg/L	<4	10	--	1	100	<4	<4
Silver (Ag)	µg/L	<0.1	--	--	0.1	0.1	<0.1	<0.1
Strontium (Sr)	µg/L	<5	--	--	--	--	15	12
Thallium (Tl)	µg/L	<0.3	--	--	0.8	0.3	<0.3	<0.3
Titanium (Ti)	µg/L	<2	--	--	--	--	<2	<2
Tungsten (W)	µg/L	<10	--	--	--	30	<10	<10
Uranium (U)	µg/L	<2	20	--	15	5	<2	<2
Vanadium (V)	µg/L	<2	--	--	--	6	<2	<2
Zinc (Zn)	µg/L	<5	--	--	30	20	14	8
Zirconium (Zr)	µg/L	<4	--	--	--	4	<4	<4
OTHER PARAMETERS								
Total Cyanide	µg/L	<2	--	--	--	--	<2	3
Free Cyanide	µg/L	<2	--	--	5	5	<2	<u>3</u>
Phenols	µg/L	<1	--	--	--	5	--	--
Sulphur (S)	µg/L	<50	--	--	--	--	--	--
NUTRIENTS								
Nitrate (NO ₃ ⁻)	µg/L as N	<50	10000	--	13000 ⁽²¹⁾	--	50	60
Nitrite (NO ₂ ⁻)	µg/L as N	<50	1000	--	60 ⁽²²⁾	--	<50	<50
Total Ammonia (NH ₃)	µg/L as N	<20	--	--	6980	--	<20	<20
Un-ionized Ammonia (NH ₃)	µg/L	--	--	--	19 ⁽²³⁾	20 ⁽²³⁾	<0.045	<0.036
Total Kjeldahl Nitrogen	µg/L	<100	--	--	--	--	--	--
Total Phosphorus (TP)	µg/L	<20	--	--	20	20	<20	<20
Phosphate (PO ₄)	µg/L as P	<100	--	--	--	--	--	--
Soluble Reactive Phosphorus	µg/L	<20	--	--	--	--	--	--
ORGANICS								
Oil and Grease (Animal/Vegetable)	µg/L	<500	--	--	--	--	--	--
Oil and Grease (Mineral)	µg/L	<500	--	--	--	--	--	--
Oil and Grease (Total)	µg/L	<500	--	--	--	physically non detect	--	--
RADIONUCLIDES								
Radium-226	Bq/L	<0.001	0.6	--	--	1 ⁽²⁴⁾	--	--

APPENDIX A
2011-2013 Surface Water Quality Results

Parameter ⁽¹⁾	Unit	Method Detection Limit	Ontario Drinking Water Standards ⁽²⁾⁽³⁾		Canadian Water Quality Guidelines ⁽⁴⁾	Provincial Water Quality Objective ⁽⁵⁾	CHLK-LS
			MAC	IMAC			22-May-2013 (T)
FIELD PARAMETERS							
pH	pH units	--	--	--	6.5-9	6.5-8.5	6.84
Temperature	degrees Celsius	--	--	--	--	-0.25	11.51
Conductivity	µS/cm	--	--	--	--	--	29
Dissolved Oxygen (DO)	µg/L	--	--	--	--	--	9760
ORP	mV	--	--	--	--	--	259.1
GENERAL PARAMETERS							
pH	pH units	--	--	--	6.5-9	6.5-8.5	6.22
Alkalinity	µg/L as CaCO ₃	<5000	--	--	--	-25%	8000
Acidity	µg/L as CaCO ₃	<5000	--	--	--	--	<5000
Electrical Conductivity (EC)	µS/cm	<2	--	--	--	--	32
Total Dissolved Solids (TDS)	µg/L	<20000	--	--	--	--	40000
Total Suspended Solids (TSS)	µg/L	<1000, <10000	--	--	+5000-25000 ⁽⁶⁾	--	<10000
Total Hardness	µg/L as CaCO ₃	<500	--	--	--	--	15800
Dissolved Organic Carbon (DOC)	µg/L	<500	--	--	--	--	11400
Total Organic Carbon (TOC)	µg/L	<500	--	--	--	--	124000
Chemical Oxygen Demand (COD)	µg/L	<5000	--	--	--	--	--
MAJOR IONS							
Calcium (Ca)	µg/L	<50	--	--	--	--	4940
Magnesium (Mg)	µg/L	<50	--	--	--	--	840
Potassium (K)	µg/L	<50	--	--	--	--	310
Sodium (Na)	µg/L	<50	--	--	--	--	870
Chloride (Cl)	µg/L	<100	--	--	--	--	190
Fluoride (F)	µg/L	<50	1500 ⁽⁷⁾	--	--	--	<50
Sulphate (SO ₄)	µg/L	<100	--	--	--	--	2860
METALS							
Aluminum (Al)	µg/L	<4	--	--	100 ⁽⁸⁾	75 ⁽⁹⁾	83
Antimony (Sb)	µg/L	<6	--	6	--	20	<3
Arsenic (As)	µg/L	<3	--	25	5	5	<3
Barium (Ba)	µg/L	<2	1000	--	--	--	4
Beryllium (Be)	µg/L	<1	--	--	--	11 ⁽¹⁰⁾	<1
Boron (B)	µg/L	<10	--	5000	1500 ⁽¹¹⁾	200	<10
Cadmium (Cd)	µg/L	<0.1	--	5	0.058 ⁽¹²⁾	0.1 ⁽¹³⁾	<0.1
Chromium (Cr)	µg/L	<3	50	--	8.9 ⁽¹⁴⁾	8.9 ⁽¹⁴⁾	<3
Cobalt (Co)	µg/L	<0.5	--	--	--	0.9	<0.5
Copper (Cu)	µg/L	<2	--	--	2 ⁽¹⁵⁾	5 ⁽¹⁶⁾	<2
Iron (Fe)	µg/L	<10	--	--	300	300	120
Lead (Pb)	µg/L	<1	10 ⁽¹⁷⁾	--	1 ⁽¹⁸⁾	3 ⁽¹⁹⁾	<1
Manganese (Mn)	µg/L	<2	--	--	--	--	19
Mercury (Hg)	µg/L	<0.10	1	--	0.026	0.2	<0.1
Molybdenum (Mo)	µg/L	<2	--	--	73	40	<2
Nickel (Ni)	µg/L	<3	--	--	25 ⁽²⁰⁾	25	<3
Selenium (Se)	µg/L	<4	10	--	1	100	<4
Silver (Ag)	µg/L	<0.1	--	--	0.1	0.1	<0.1
Strontium (Sr)	µg/L	<5	--	--	--	--	10
Thallium (Tl)	µg/L	<0.3	--	--	0.8	0.3	<0.3
Titanium (Ti)	µg/L	<2	--	--	--	--	<2
Tungsten (W)	µg/L	<10	--	--	--	30	<10
Uranium (U)	µg/L	<2	20	--	15	5	<2
Vanadium (V)	µg/L	<2	--	--	--	6	<2
Zinc (Zn)	µg/L	<5	--	--	30	20	<5
Zirconium (Zr)	µg/L	<4	--	--	--	4	<4
OTHER PARAMETERS							
Total Cyanide	µg/L	<2	--	--	--	--	<2
Free Cyanide	µg/L	<2	--	--	5	5	<2
Phenols	µg/L	<1	--	--	--	5	1
Sulphur (S)	µg/L	<50	--	--	--	--	--
Total Ammonia (NH₃ + NH₄)							
Nitrate (NO ₃ ⁻)	µg/L as N	<50	10000	--	13000 ⁽²¹⁾	--	<50
Nitrite (NO ₂ ⁻)	µg/L as N	<50	1000	--	60 ⁽²²⁾	--	<50
Total Phosphorus (P)	µg/L as N	<20	--	--	6980	--	<20
Un-ionized Ammonia (NH ₃)	µg/L	--	--	--	19 ⁽²³⁾	20 ⁽²³⁾	--
Total Kjeldahl Nitrogen	µg/L	<100	--	--	--	--	--
Total Phosphorus (TP)	µg/L	<20	--	--	20	20	<20
Phosphate (PO ₄)	µg/L as P	<100	--	--	--	--	--
Soluble Reactive Phosphorus	µg/L	<20	--	--	--	--	--
ORGANICS							
Oil and Grease (Animal/Vegetable)	µg/L	<500	--	--	--	--	<500
Oil and Grease (Mineral)	µg/L	<500	--	--	--	--	<500
Oil and Grease (Total)	µg/L	<500	--	--	--	physically non detect	<500
Polychlorinated Biphenyls	µg/L	<0.1	--	0.003	--	0.001	<0.1
Naphthalene	µg/L	<0.2	--	--	1.1	7	<0.2
Acenaphthylene	µg/L	<0.2	--	--	--	--	<0.2
Acenaphthene	µg/L	<0.2	--	--	5.8	--	<0.2
Fluorene	µg/L	<0.2	--	--	3	0.2	<0.2
Phenanthrene	µg/L	<0.1	--	--	0.4	0.03	<0.1
Anthracene	µg/L	<0.1	--	--	0.012	0.0008	<0.1
Fluoranthene	µg/L	<0.2	--	--	0.04	0.0008	<0.2
Pyrene	µg/L	<0.2	--	--	0.025	--	<0.2
Benz(a)anthracene	µg/L	<0.2	--	--	0.018	0.0004	<0.2
Chrysene	µg/L	<0.1	--	--	--	0.0001	<0.1
Benzo(b)fluoranthene	µg/L	<0.1	--	--	--	--	<0.1
Benzo(k)fluoranthene	µg/L	<0.1	--	--	--	0.0002	<0.1
Benzo(a)pyrene	µg/L	<0.01	--	--	0.015	--	<0.01
Indeno(1,2,3-cd)pyrene	µg/L	<0.2	--	--	--	--	<0.2
Dibenz(a,h)anthracene	µg/L	<0.2	--	--	--	0.002	<0.2
Benzo(g,h,i)perylene	µg/L	<0.2	--	--	--	0.00002	<0.2
2-and 1-methyl Naphthalene	µg/L	<0.2	--	--	--	--	<0.2
RADIONUCLIDES							
Radium-226	Bq/L	<0.001	0.6	--	--	1 ⁽²⁴⁾	--

APPENDIX A
2011-2013 Surface Water Quality Results

Parameter ⁽¹⁾	Unit	Method Detection Limit	Ontario Drinking Water Standards ⁽²⁾⁽³⁾		Canadian Water Quality Guidelines ⁽⁴⁾	Provincial Water Quality Objective ⁽⁵⁾	P-2 - Drainage from Beaver Pond		P-5 - Seasonal Pond	
			MAC	IMAC			19-Nov-12	24-Feb-13	23-May-12	19-Nov-12
FIELD PARAMETERS										
pH	pH units	--	--	--	6.5-9	6.5-8.5	6.43	6.51	6.98	6.31
Temperature	degrees Celsius	--	--	--	--	-0.25	2.7	-0.1	19.5	3.5
Conductivity	µS/cm	--	--	--	--	--	30.2	65.8	37.4	28.7
Dissolved Oxygen (DO)	µg/L	--	--	--	--	--	887	6130	6000	941
GENERAL PARAMETERS										
pH	pH units	--	--	--	6.5-9	6.5-8.5	6.43	6.64	6.55	6.18
Alkalinity	µg/L as CaCO ₃	<5000	--	--	--	-25%	13000	52000	16000	10000
Acidity	µg/L as CaCO ₃	<5000	--	--	--	--	--	--	--	--
Electrical Conductivity (EC)	µS/cm	<2	--	--	--	--	49	118	44	47
Total Dissolved Solids (TDS)	µg/L	<20000	--	--	--	--	72000	108000	62000	82000
Total Suspended Solids (TSS)	µg/L	<1000, <10000	--	--	+5000-25000 ⁽⁶⁾	--	4000	5000	<10000	2000
Total Hardness	µg/L as CaCO ₃	<500	--	--	--	--	25200	60400	20700	25600
Dissolved Organic Carbon (DOC)	µg/L	<500	--	--	--	--	26300	30700	23100	25900
Total Organic Carbon (TOC)	µg/L	<500	--	--	--	--	--	--	--	--
Chemical Oxygen Demand (COD)	µg/L	<5000	--	--	--	--	--	--	--	--
MAJOR IONS										
Calcium (Ca)	µg/L	<50	--	--	--	--	7980	19300	6410	8060
Magnesium (Mg)	µg/L	<50	--	--	--	--	1280	2960	1140	1340
Potassium (K)	µg/L	<50	--	--	--	--	380	720	620	900
Sodium (Na)	µg/L	<50	--	--	--	--	1000	1190	900	1020
Chloride (Cl)	µg/L	<100	--	--	--	--	340	540	350	750
Fluoride (F)	µg/L	<50	150 ⁽⁷⁾	--	--	--	<50	<50	<50	<50
Sulphate (SO ₄)	µg/L	<100	--	--	--	--	4000	1960	300	3370
METALS										
Aluminum (Al)	µg/L	<4	--	--	100 ⁽⁸⁾	75 ⁽⁹⁾	143	237	37	93
Antimony (Sb)	µg/L	<6	--	6	--	20	<6	<6	<6	<6
Arsenic (As)	µg/L	<3	--	25	5	5	<3	<3	<3	<3
Barium (Ba)	µg/L	<2	1000	--	--	--	7	19	6	7
Beryllium (Be)	µg/L	<1	--	--	--	11 ⁽¹⁰⁾	<1	<1	<1	<1
Boron (B)	µg/L	<10	--	5000	1500 ⁽¹¹⁾	200	<10	<10	<10	<10
Cadmium (Cd)	µg/L	<0.1	--	5	0.058 ⁽¹²⁾	0.1 ⁽¹³⁾	<0.1	<0.1	<0.1	<0.1
Chromium (Cr)	µg/L	<3	50	--	8.9 ⁽¹⁴⁾	8.9 ⁽¹⁴⁾	<3	<3	<3	<3
Cobalt (Co)	µg/L	<0.5	--	--	--	0.9	<0.5	2.2	<0.5	<0.5
Copper (Cu)	µg/L	<2	--	--	2 ⁽¹⁵⁾	5 ⁽¹⁶⁾	<2	<2	<2	<2
Iron (Fe)	µg/L	<10	--	--	300	300	707	4000	302	298
Lead (Pb)	µg/L	<1	10 ⁽¹⁷⁾	--	1 ⁽¹⁸⁾	3 ⁽¹⁹⁾	<1	<1	<1	<1
Manganese (Mn)	µg/L	<2	--	--	--	--	33	577	67	44
Mercury (Hg)	µg/L	<0.10	1	--	0.026	0.2	<0.10	<0.10	<0.10	<0.10
Molybdenum (Mo)	µg/L	<2	--	--	73	40	<2	<2	<2	<2
Nickel (Ni)	µg/L	<3	--	--	25 ⁽²⁰⁾	25	<3	<3	<3	<3
Selenium (Se)	µg/L	<4	10	--	1	100	<4	<4	<4	<4
Silver (Ag)	µg/L	<0.1	--	--	0.1	0.1	<0.1	<0.1	<0.1	<0.1
Strontium (Sr)	µg/L	<5	--	--	--	--	19	43	14	17
Thallium (Tl)	µg/L	<0.3	--	--	0.8	0.3	<0.3	<0.3	<0.3	<0.3
Titanium (Ti)	µg/L	<2	--	--	--	--	3	6	<2	<2
Tungsten (W)	µg/L	<10	--	--	--	30	<10	<10	<10	<10
Uranium (U)	µg/L	<2	20	--	15	5	<2	<2	<2	<2
Vanadium (V)	µg/L	<2	--	--	--	6	<2	<2	<2	<2
Zinc (Zn)	µg/L	<5	--	--	30	20	20	7	67	45
Zirconium (Zr)	µg/L	<4	--	--	--	4	<4	<4	<4	<4
OTHER PARAMETERS										
Total Cyanide	µg/L	<2	--	--	--	--	<2	<2	3	<2
Sulphur (S)	µg/L	<50	--	--	--	--	--	--	--	--
NUTRIENTS										
Nitrate (NO ₃ ⁻)	µg/L as N	<50	10000	--	13000 ⁽²¹⁾	--	--	--	--	--
Nitrite (NO ₂ ⁻)	µg/L as N	<50	1000	--	60 ⁽²²⁾	--	--	--	--	--
Total Ammonia (NH ₃ + NH ₄)	µg/L as N	<20	--	--	6980	--	60	550	<20	80
Un-ionized Ammonia (NH ₃)	µg/L	--	--	--	19 ⁽²³⁾	20 ⁽²³⁾	0.02	0.14	<0.08	0.03
Total Kjeldahl Nitrogen	µg/L	<100	--	--	--	--	--	--	--	--
Total Phosphorus (P)	µg/L	<20	--	--	20	20	<20	40	50	<20
Phosphate (PO ₄)	µg/L as P	<100	--	--	--	--	--	--	--	--
Soluble Reactive Phosphorus	µg/L	<20	--	--	--	--	--	--	--	--
ORGANICS										
Oil and Grease (Animal/Vegetable)	µg/L	<500	--	--	--	--	--	--	--	--
Oil and Grease (Mineral)	µg/L	<500	--	--	--	--	--	--	--	--
Oil and Grease (Total)	µg/L	<500	--	--	--	physically non detect	--	--	--	--
RADIONUCLIDES										
Radium-226	Bq/L	<0.001	0.6	--	--	1 ⁽²⁴⁾	<0.001	<0.001	--	<0.001

APPENDIX A
2011-2013 Surface Water Quality Results

Parameter ⁽¹⁾	Unit	Method Detection Limit	Ontario Drinking Water Standards ⁽²⁾⁽³⁾		Canadian Water Quality Guidelines ⁽⁴⁾	Provincial Water Quality Objective ⁽⁵⁾	P-7 - Inflow to Three Ducks Lakes			
			MAC	IMAC			23-May-12	20-Aug-12	19-Nov-12	24-Feb-13
FIELD PARAMETERS										
pH	pH units	--	--	--	6.5-9	6.5-8.5	6.84	6.45	6.81	6.94
Temperature	degrees Celsius	--	--	--	--	-0.25	20.2	15.5	3.8	0.1
Conductivity	µS/cm	--	--	--	--	--	43.5	66	30.2	32.9
Dissolved Oxygen (DO)	µg/L	--	--	--	--	--	7090	8260	11400	7550
GENERAL PARAMETERS										
pH	pH units	--	--	--	6.5-9	6.5-8.5	6.75	6.83	6.64	7.17
Alkalinity	µg/L as CaCO3	<5000	--	--	--	-25%	16000	29000	15000	28000
Acidity	µg/L as CaCO3	<5000	--	--	--	--	--	--	--	--
Electrical Conductivity (EC)	µS/cm	<2	--	--	--	--	47	70	49	62
Total Dissolved Solids (TDS)	µg/L	<20000	--	--	--	--	42000	64000	66000	32000
Total Suspended Solids (TSS)	µg/L	<1000, <10000	--	--	+5000-25000 ⁽⁶⁾	--	<10000	13000	<1000	1000
Total Hardness	µg/L as CaCO3	<500	--	--	--	--	22300	34800	24700	29200
Dissolved Organic Carbon (DOC)	µg/L	<500	--	--	--	--	12100	6900	13000	13200
Total Organic Carbon (TOC)	µg/L	<500	--	--	--	--	--	--	--	--
Chemical Oxygen Demand (COD)	µg/L	<5000	--	--	--	--	--	--	--	--
MAJOR IONS										
Calcium (Ca)	µg/L	<50	--	--	--	--	6700	10600	7600	8830
Magnesium (Mg)	µg/L	<50	--	--	--	--	1360	2020	1400	1740
Potassium (K)	µg/L	<50	--	--	--	--	380	320	470	460
Sodium (Na)	µg/L	<50	--	--	--	--	1010	1090	1270	1160
Chloride (Cl)	µg/L	<100	--	--	--	--	710	860	1320	1160
Fluoride (F)	µg/L	<50	1500 ⁽⁷⁾	--	--	--	<50	<50	<50	<50
Sulphate (SO ₄)	µg/L	<100	--	--	--	--	2950	2300	3530	3340
METALS										
Aluminum (Al)	µg/L	<4	--	--	100 ⁽⁸⁾	75 ⁽⁹⁾	54	17	69	70
Antimony (Sb)	µg/L	<6	--	6	--	20	<6	<6	<6	<6
Arsenic (As)	µg/L	<3	--	25	5	5	<3	<3	<3	<3
Barium (Ba)	µg/L	<2	1000	--	--	--	4	7	5	6
Beryllium (Be)	µg/L	<1	--	--	--	11 ⁽¹⁰⁾	<1	<1	<1	<1
Boron (B)	µg/L	<10	--	5000	1500 ⁽¹¹⁾	200	<10	<10	<10	<10
Cadmium (Cd)	µg/L	<0.1	--	5	0.058 ⁽¹²⁾	0.1 ⁽¹³⁾	<0.1	<0.1	<0.1	<0.1
Chromium (Cr)	µg/L	<3	50	--	8.9 ⁽¹⁴⁾	8.9 ⁽¹⁴⁾	<3	<3	<3	<3
Cobalt (Co)	µg/L	<0.5	--	--	--	0.9	<0.5	<0.5	<0.5	<0.5
Copper (Cu)	µg/L	<2	--	--	2 ⁽¹⁵⁾	5 ⁽¹⁶⁾	<2	<2	<2	<2
Iron (Fe)	µg/L	<10	--	--	300	300	189	449	170	273
Lead (Pb)	µg/L	<1	10 ⁽¹⁷⁾	--	1 ⁽¹⁸⁾	3 ⁽¹⁹⁾	<1	<1	<1	<1
Manganese (Mn)	µg/L	<2	--	--	--	--	21	144	7	24
Mercury (Hg)	µg/L	<0.10	1	--	0.026	0.2	<0.10	--	<0.10	<0.10
Molybdenum (Mo)	µg/L	<2	--	--	73	40	<2	<2	<2	<2
Nickel (Ni)	µg/L	<3	--	--	25 ⁽²⁰⁾	25	<3	<3	<3	<3
Selenium (Se)	µg/L	<4	10	--	1	100	<4	<4	<4	<4
Silver (Ag)	µg/L	<0.1	--	--	0.1	0.1	<0.1	<0.1	<0.1	<0.1
Strontium (Sr)	µg/L	<5	--	--	--	--	15	20	13	15
Thallium (Tl)	µg/L	<0.3	--	--	0.8	0.3	<0.3	<0.3	<0.3	<0.3
Titanium (Ti)	µg/L	<2	--	--	--	--	<2	<2	<2	<2
Tungsten (W)	µg/L	<10	--	--	--	30	<10	<10	<10	<10
Uranium (U)	µg/L	<2	20	--	15	5	<2	<2	<2	<2
Vanadium (V)	µg/L	<2	--	--	--	6	<2	<2	<2	<2
Zinc (Zn)	µg/L	<5	--	--	30	20	13	<5	7	<5
Zirconium (Zr)	µg/L	<4	--	--	--	4	<4	<4	<4	<4
OTHER PARAMETERS										
Total Cyanide	µg/L	<2	--	--	--	--	<2	<2	<2	<2
Sulphur (S)	µg/L	<50	--	--	--	--	--	--	--	--
NUTRIENTS										
Nitrate (NO ₃ ⁻)	µg/L as N	<50	10000	--	13000 ⁽²¹⁾	--	--	--	--	--
Nitrite (NO ₂ ⁻)	µg/L as N	<50	1000	--	60 ⁽²²⁾	--	--	--	--	--
Total Ammonia (NH ₃ + NH ₄)	µg/L as N	<20	--	--	6980	--	<20	<20	<20	70
Un-ionized Ammonia (NH ₃)	µg/L	--	--	--	19 ⁽²³⁾	20 ⁽²³⁾	<0.08	<0.02	--	0.06
Total Kjeldahl Nitrogen	µg/L	<100	--	--	--	--	--	--	--	--
Total Phosphorus (P)	µg/L	<20	--	--	20	20	30	30	<20	<20
Phosphate (PO ₄)	µg/L as P	<100	--	--	--	--	--	--	--	--
Soluble Reactive Phosphorus	µg/L	<20	--	--	--	--	--	--	--	--
ORGANICS										
Oil and Grease (Animal/Vegetable)	µg/L	<500	--	--	--	--	--	--	--	--
Oil and Grease (Mineral)	µg/L	<500	--	--	--	--	--	--	--	--
Oil and Grease (Total)	µg/L	<500	--	--	--	physically non detect	--	--	--	--
RADIONUCLIDES										
Radium-226	Bq/L	<0.001	0.6	--	--	1 ⁽²⁴⁾	--	--	<0.001	<0.001

APPENDIX A
2011-2013 Surface Water Quality Results

Parameter ⁽¹⁾	Unit	Method Detection Limit	Ontario Drinking Water Standards ⁽²⁾⁽³⁾		Canadian Water Quality Guidelines ⁽⁴⁾	Provincial Water Quality Objective ⁽⁵⁾	P-4 - Inflow to Mollie River		
			MAC	IMAC			23-May-12	19-Nov-12	24-Feb-13
FIELD PARAMETERS									
pH	pH units	--	--	--	6.5-9	6.5-8.5	6.4	6.4	6.95
Temperature	degrees Celsius	--	--	--	--	-0.25	17	2.8	0
Conductivity	µS/cm	--	--	--	--	--	32.3	24.5	20.5
Dissolved Oxygen (DO)	µg/L	--	--	--	--	--	6540	1241	12850
GENERAL PARAMETERS									
pH	pH units	--	--	--	6.5-9	6.5-8.5	6.55	6.43	6.19
Alkalinity	µg/L as CaCO ₃	<5000	--	--	--	-25%	11000	13000	8000
Acidity	µg/L as CaCO ₃	<5000	--	--	--	--	--	--	--
Electrical Conductivity (EC)	µS/cm	<2	--	--	--	--	8	49	38
Total Dissolved Solids (TDS)	µg/L	<20000	--	--	--	--	54000	72000	54000
Total Suspended Solids (TSS)	µg/L	<1000, <10000	--	--	+5000-25000 ⁽⁶⁾	--	<10000	4000	4000
Total Hardness	µg/L as CaCO ₃	<500	--	--	--	--	20400	25200	20800
Dissolved Organic Carbon (DOC)	µg/L	<500	--	--	--	--	18200	26300	21500
Total Organic Carbon (TOC)	µg/L	<500	--	--	--	--	--	--	--
Chemical Oxygen Demand (COD)	µg/L	<5000	--	--	--	--	--	--	--
MAJOR IONS									
Calcium (Ca)	µg/L	<50	--	--	--	--	6250	7980	6350
Magnesium (Mg)	µg/L	<50	--	--	--	--	1160	1280	1190
Potassium (K)	µg/L	<50	--	--	--	--	350	380	230
Sodium (Na)	µg/L	<50	--	--	--	--	810	1000	830
Chloride (Cl)	µg/L	<100	--	--	--	--	290	340	320
Fluoride (F)	µg/L	<50	1500 ⁽⁷⁾	--	--	--	<50	<50	<50
Sulphate (SO ₄)	µg/L	<100	--	--	--	--	1900	4000	2870
METALS									
Aluminum (Al)	µg/L	<4	--	--	100 ⁽⁸⁾	75 ⁽⁹⁾	126	138	136
Antimony (Sb)	µg/L	<6	--	6	--	20	<6	<6	<6
Arsenic (As)	µg/L	<3	--	25	5	5	<3	<3	<3
Barium (Ba)	µg/L	<2	1000	--	--	--	6	7	5
Beryllium (Be)	µg/L	<1	--	--	--	11 ⁽¹⁰⁾	<1	<1	<1
Boron (B)	µg/L	<10	--	5000	1500 ⁽¹¹⁾	200	<10	<10	<10
Cadmium (Cd)	µg/L	<0.1	--	5	0.058 ⁽¹²⁾	0.1 ⁽¹³⁾	<0.1	<0.1	<0.1
Chromium (Cr)	µg/L	<3	50	--	8.9 ⁽¹⁴⁾	8.9 ⁽¹⁴⁾	<3	<3	<3
Cobalt (Co)	µg/L	<0.5	--	--	--	0.9	<0.5	<0.5	<0.5
Copper (Cu)	µg/L	<2	--	--	2 ⁽¹⁵⁾	5 ⁽¹⁶⁾	<2	<2	<2
Iron (Fe)	µg/L	<10	--	--	300	300	466	70Z	242
Lead (Pb)	µg/L	<1	10 ⁽¹⁷⁾	--	1 ⁽¹⁸⁾	3 ⁽¹⁹⁾	<1	<1	<1
Manganese (Mn)	µg/L	<2	--	--	--	--	80	33	21
Mercury (Hg)	µg/L	<0.10	1	--	0.026	0.2	<0.10	<0.10	<0.10
Molybdenum (Mo)	µg/L	<2	--	--	73	40	<2	<2	<2
Nickel (Ni)	µg/L	<3	--	--	25 ⁽²⁰⁾	25	<3	<3	<3
Selenium (Se)	µg/L	<4	10	--	1	100	<4	<4	<4
Silver (Ag)	µg/L	<0.1	--	--	0.1	0.1	<0.1	<0.1	<0.1
Strontium (Sr)	µg/L	<5	--	--	--	--	19	19	14
Thallium (Tl)	µg/L	<0.3	--	--	0.8	0.3	<0.3	<0.3	<0.3
Titanium (Ti)	µg/L	<2	--	--	--	--	3	3	<2
Tungsten (W)	µg/L	<10	--	--	--	30	<10	<10	<10
Uranium (U)	µg/L	<2	20	--	15	5	<2	<2	<2
Vanadium (V)	µg/L	<2	--	--	--	6	<2	<2	<2
Zinc (Zn)	µg/L	<5	--	--	30	20	160	20	12
Zirconium (Zr)	µg/L	<4	--	--	--	4	<4	<4	<4
OTHER PARAMETERS									
Total Cyanide	µg/L	<2	--	--	--	--	3	<2	<2
Sulphur (S)	µg/L	<50	--	--	--	--	--	--	--
NUTRIENTS									
Nitrate (NO ₃ ⁻)	µg/L as N	<50	10000	--	13000 ⁽²¹⁾	--	--	--	--
Nitrite (NO ₂ ⁻)	µg/L as N	<50	1000	--	60 ⁽²²⁾	--	--	--	--
Total Ammonia (NH ₃ + NH ₄)	µg/L as N	<20	--	--	6980	--	<20	60	30
Un-ionized Ammonia (NH ₃)	µg/L	--	--	--	19 ⁽²³⁾	20 ⁽²³⁾	<0.02	0.02	0.02
Total Kjeldahl Nitrogen	µg/L	<100	--	--	--	--	--	--	--
Total Phosphorus (P)	µg/L	<20	--	--	20	20	30	<20	<20
Phosphate (PO ₄)	µg/L as P	<100	--	--	--	--	--	--	--
Soluble Reactive Phosphorus	µg/L	<20	--	--	--	--	--	--	--
ORGANICS									
Oil and Grease (Animal/Vegetable)	µg/L	<500	--	--	--	--	--	--	--
Oil and Grease (Mineral)	µg/L	<500	--	--	--	--	--	--	--
Oil and Grease (Total)	µg/L	<500	--	--	--	physically non detect	--	--	--

2011-2013 Surface Water Quality Results

Parameter ⁽¹⁾	Unit	Method Detection Limit	Ontario Drinking Water Standards ⁽²⁾⁽³⁾		Canadian Water Quality Guidelines ⁽⁴⁾	Provincial Water Quality Objective ⁽⁵⁾	P-1
			MAC	IMAC			24-Feb-13
FIELD PARAMETERS							
pH	pH units	--	--	--	6.5-9	6.5-8.5	6.87
Temperature	degrees Celsius	--	--	--	--	-0.25	-0.1
Conductivity	µS/cm	--	--	--	--	--	26.1
Dissolved Oxygen (DO)	µg/L	--	--	--	--	--	8130
GENERAL PARAMETERS							
pH	pH units	--	--	--	6.5-9	6.5-8.5	6.42
Alkalinity	µg/L as CaCO ₃	<5000	--	--	--	-25%	16000
Acidity	µg/L as CaCO ₃	<5000	--	--	--	--	--
Electrical Conductivity (EC)	µS/cm	<2	--	--	--	--	51
Total Dissolved Solids (TDS)	µg/L	<20000	--	--	--	--	28000
Total Suspended Solids (TSS)	µg/L	<1000, <10000	--	--	+5000-25000 ⁽⁶⁾	--	<1000
Total Hardness	µg/L as CaCO ₃	<500	--	--	--	--	24400
Dissolved Organic Carbon (DOC)	µg/L	<500	--	--	--	--	16400
Total Organic Carbon (TOC)	µg/L	<500	--	--	--	--	--
Chemical Oxygen Demand (COD)	µg/L	<5000	--	--	--	--	--
MAJOR IONS							
Calcium (Ca)	µg/L	<50	--	--	--	--	7610
Magnesium (Mg)	µg/L	<50	--	--	--	--	1300
Potassium (K)	µg/L	<50	--	--	--	--	320
Sodium (Na)	µg/L	<50	--	--	--	--	710
Chloride (Cl)	µg/L	<100	--	--	--	--	330
Fluoride (F)	µg/L	<50	1500 ⁽⁷⁾	--	--	--	<50
Sulphate (SO ₄)	µg/L	<100	--	--	--	--	2780
METALS							
Aluminum (Al)	µg/L	<4	--	--	100 ⁽⁸⁾	75 ⁽⁹⁾	40
Antimony (Sb)	µg/L	<6	--	6	--	20	<6
Arsenic (As)	µg/L	<3	--	25	5	5	<3
Barium (Ba)	µg/L	<2	1000	--	--	--	9
Beryllium (Be)	µg/L	<1	--	--	--	11 ⁽¹⁰⁾	<1
Boron (B)	µg/L	<10	--	5000	1500 ⁽¹¹⁾	200	<10
Cadmium (Cd)	µg/L	<0.1	--	5	0.058 ⁽¹²⁾	0.1 ⁽¹³⁾	<0.1
Chromium (Cr)	µg/L	<3	50	--	8.9 ⁽¹⁴⁾	8.9 ⁽¹⁴⁾	<3
Cobalt (Co)	µg/L	<0.5	--	--	--	0.9	<0.5
Copper (Cu)	µg/L	<2	--	--	2 ⁽¹⁵⁾	5 ⁽¹⁶⁾	<2
Iron (Fe)	µg/L	<10	--	--	300	300	243
Lead (Pb)	µg/L	<1	10 ⁽¹⁷⁾	--	1 ⁽¹⁸⁾	3 ⁽¹⁹⁾	<1
Manganese (Mn)	µg/L	<2	--	--	--	--	72
Mercury (Hg)	µg/L	<0.10	1	--	0.026	0.2	<0.10
Molybdenum (Mo)	µg/L	<2	--	--	73	40	<2
Nickel (Ni)	µg/L	<3	--	--	25 ⁽²⁰⁾	25	<3
Selenium (Se)	µg/L	<4	10	--	1	100	<4
Silver (Ag)	µg/L	<0.1	--	--	0.1	0.1	<0.1
Strontium (Sr)	µg/L	<5	--	--	--	--	16
Thallium (Tl)	µg/L	<0.3	--	--	0.8	0.3	<0.3
Titanium (Ti)	µg/L	<2	--	--	--	--	<2
Tungsten (W)	µg/L	<10	--	--	--	30	<10
Uranium (U)	µg/L	<2	20	--	15	5	<2
Vanadium (V)	µg/L	<2	--	--	--	6	<2
Zinc (Zn)	µg/L	<5	--	--	30	20	<5
Zirconium (Zr)	µg/L	<4	--	--	--	4	<4
OTHER PARAMETERS							
Total Cyanide	µg/L	<2	--	--	--	--	<2
Sulphur (S)	µg/L	<50	--	--	--	--	--
NUTRIENTS							
Nitrate (NO ₃ ⁻)	µg/L as N	<50	10000	--	13000 ⁽²¹⁾	--	--
Nitrite (NO ₂ ⁻)	µg/L as N	<50	1000	--	60 ⁽²²⁾	--	--
Total Ammonia (NH ₃ + NH ₄)	µg/L as N	<20	--	--	6980	--	340
Un-ionized Ammonia (NH ₃)	µg/L	--	--	--	19 ⁽²³⁾	20 ⁽²³⁾	0.28
Total Kjeldahl Nitrogen	µg/L	<100	--	--	--	--	--
Total Phosphorus (P)	µg/L	<20	--	--	20	20	<20
Phosphate (PO ₄)	µg/L as P	<100	--	--	--	--	--
Soluble Reactive Phosphorus	µg/L	<20	--	--	--	--	--
ORGANICS							
Oil and Grease (Animal/Vegetable)	µg/L	<500	--	--	--	--	--
Oil and Grease (Mineral)	µg/L	<500	--	--	--	--	--
Oil and Grease (Total)	µg/L	<500	--	--	--	physically non detect	--
RADIONUCLIDES							
Radium-226	Bq/L	<0.001	0.6	--	--	1 ⁽²⁴⁾	<0.001

APPENDIX A
2011-2013 Surface Water Quality Results

Parameter ⁽¹⁾	Unit	Method Detection Limit	Ontario Drinking Water Standards ⁽²⁾⁽³⁾		Canadian Water Quality Guidelines ⁽⁴⁾	Provincial Water Quality Objective ⁽⁵⁾	3D-c - Three Ducks Lakes, near Outlet												
			MAC	IMAC			21-Feb-12	26-Mar-12	11-May-12	31-May-12	28-Jun-12	18-Jul-12	20-Aug-12	24-Sep-12	30-Oct-12	19-Nov-12	29-Jan-13	24-Feb-13	19-Mar-13
FIELD PARAMETERS																			
pH	pH units	--	--	--	6.5-9	6.5-8.5	7.2	7.5	--	7.19	7	7.21	7.29	7.12	7.8	7.15	7.5	6.89	7.83
Temperature	degrees Celsius	--	--	--	--	-0.25	1.1	2.5	--	17.9	21.5	21.5	19.3	10.7	4.6	3	0.1	-0.1	0.1
Conductivity	µS/cm	--	--	--	--	--	22.2	21.3	--	33.8	38.7	40.4	38.5	24.6	25.6	24.7	29	27	24.5
Dissolved Oxygen (DO)	µg/L	--	--	--	--	--	7500	1210	--	8710	7530	7050	7960	9070	11100	1196	12250	9860	9600
GENERAL PARAMETERS																			
pH	pH units	--	--	--	6.5-9	6.5-8.5	6.74	6.75	6.85	6.58	7.06	6.6	6.93	6.91	6.7	6.6	6.57	6.38	6.41
Alkalinity	µg/L as CaCO3	<5000	--	--	--	-25%	12000	12000	12000	12000	12000	13000	14000	13000	12000	12000	16000	15000	13000
Acidity	µg/L as CaCO3	<5000	--	--	--	--	--	--	--	--	--	--	--	--	--	--	--	--	--
Electrical Conductivity (EC)	µS/cm	<2	--	--	--	--	40	38	38	39	41	42	46	42	42	42	54	51	49
Total Dissolved Solids (TDS)	µg/L	<20000	--	--	--	--	38000	78000	56000	62000	48000	48000	50000	58000	50000	52000	<20000	<20000	42000
Total Suspended Solids (TSS)	µg/L	<1000, <10000	--	--	+5000-25000 ⁽⁶⁾	--	<10000	<10000	<10000	<10000	<10000	<10000	<10000	<1000	2000	1000	<1000	<1000	<1000
Total Hardness	µg/L as CaCO3	<500	--	--	--	--	18700	18100	18400	18100	17300	20100	20200	21400	19800	20800	24700	24200	21100
Dissolved Organic Carbon (DOC)	µg/L	<500	--	--	--	--	15500	12100	11500	9800	14600	10900	8500	10400	11800	11800	13300	12800	12200
Total Organic Carbon (TOC)	µg/L	<500	--	--	--	--	--	--	--	--	--	--	--	--	--	--	--	--	--
Chemical Oxygen Demand (COD)	µg/L	<5000	--	--	--	--	--	--	--	--	--	--	--	--	--	--	--	--	--
MAJOR IONS																			
Calcium (Ca)	µg/L	<50	--	--	--	--	5780	5600	5660	5560	5300	6150	6190	6590	6100	6530	7580	7440	6490
Magnesium (Mg)	µg/L	<50	--	--	--	--	1030	990	1040	1030	990	1150	1160	1210	1100	1080	1390	1360	1180
Potassium (K)	µg/L	<50	--	--	--	--	410	380	380	400	360	450	440	430	390	500	400	410	430
Sodium (Na)	µg/L	<50	--	--	--	--	880	760	800	890	790	960	860	910	850	1040	1110	1090	1100
Chloride (Cl)	µg/L	<100	--	--	--	--	510	430	590	590	510	570	590	590	580	680	990	880	930
Fluoride (F)	µg/L	<50	1500 ⁽⁷⁾	--	--	--	<50	<50	<50	<50	<50000	<50	<50	<50	<50	<50	<50	<50	<50
Sulphate (SO ₄)	µg/L	<100	--	--	--	--	2510	2510	2660	2600	2680	2600	2630	2490	2910	2970	3620	3250	3140
METALS																			
Aluminum (Al)	µg/L	<4	--	--	100 ⁽⁸⁾	75 ⁽⁹⁾	55	58	55	45	43	18	11	13	40	42	54	52	60
Antimony (Sb)	µg/L	<6	--	6	--	20	<6	<6	<6	<6	<6	<6	<6	<6	<6	<6	<6	<6	<6
Arsenic (As)	µg/L	<3	--	25	5	5	<3	<3	<3	<3	<3	<3	<3	<3	<3	<3	<3	<3	<3
Barium (Ba)	µg/L	<2	1000	--	--	--	4	4	4	4	4	4	4	4	4	4	5	6	6
Beryllium (Be)	µg/L	<1	--	--	--	11 ⁽¹⁰⁾	<1	<1	<1	<1	<1	<1	<1	<1	<1	<1	<1	<1	<1
Boron (B)	µg/L	<10	--	5000	1500 ⁽¹¹⁾	200	<10	<10	<10	<10	<10	<10	<10	<10	<10	<10	<10	<10	<10
Cadmium (Cd)	µg/L	<0.1	--	5	0.058 ⁽¹²⁾	0.1 ⁽¹³⁾	<0.1	<0.1	<0.1	<0.1	<0.1	<0.1	<0.1	<0.1	<0.1	<0.1	<0.1	<0.1	<0.1
Chromium (Cr)	µg/L	<3	50	--	8.9 ⁽¹⁴⁾	8.9 ⁽¹⁴⁾	<3	<3	<3	<3	<3	<3	<3	<3	<3	<3	<3	<3	<3
Cobalt (Co)	µg/L	<0.5	--	--	--	0.9	<0.5	<0.5	<0.5	<0.5	<0.5	<0.5	<0.5	<0.5	<0.5	<0.5	<0.5	<0.5	<0.5
Copper (Cu)	µg/L	<2	--	--	2 ⁽¹⁵⁾	5 ⁽¹⁶⁾	<2	<2	<2	<2	<2	<2	<2	<2	<2	<2	<2	<2	<2
Iron (Fe)	µg/L	<10	--	--	300	300	155	227	114	93	104	128	84	132	96	106	97	107	99
Lead (Pb)	µg/L	<1	10 ⁽¹⁷⁾	--	1 ⁽¹⁸⁾	3 ⁽¹⁹⁾	<1	<1	<1	<1	<1	<1	<1	<1	<1	<1	<1	<1	<1
Manganese (Mn)	µg/L	<2	--	--	--	--	18	38	12	12	22	36	20	20	13	11	10	9	9
Mercury (Hg)	µg/L	<0.10	1	--	0.026	0.2	<0.10	<0.10	<0.10	<0.10	<0.10	<0.10	--	<0.10	<0.10	<0.10	<0.10	<0.10	<0.10
Molybdenum (Mo)	µg/L	<2	--	--	73	40	<2	<2	<2	<2	<2	<2	<2	<2	<2	<2	<2	<2	<2
Nickel (Ni)	µg/L	<3	--	--	25 ⁽²⁰⁾	25	<3	<3	<3	<3	<3	<3	<3	<3	<3	<3	<3	<3	<3
Selenium (Se)	µg/L	<4	10	--	1	100	<4	<4	<4	<4	<4	<4	<4	<4	<4	<4	<4	<4	<4
Silver (Ag)	µg/L	<0.1	--	--	0.1	0.1	<0.1	<0.1	<0.1	<0.1	<0.1	<0.1	<0.1	<0.1	<0.1	<0.1	<0.1	<0.1	<0.1
Strontium (Sr)	µg/L	<5	--	--	--	--	12	11	13	11	12	14	14	15	13	12	17	15	14
Thallium (Tl)	µg/L	<0.3	--	--	0.8	0.3	<0.3	<0.3	<0.3	<0.3	<0.3	<0.3	<0.3	<0.3	<0.3	<0.3	<0.3	<0.3	<0.3
Titanium (Ti)	µg/L	<2	--	--	--	--	<2	<2	<2	<2	<2	<2	<2	<2	<2	<2	<2	<2	<2
Tungsten (W)	µg/L	<10	--	--	--	30	<10	<10	<10	<10	<10	<10	<10	<10	<10	<10	<10	<10	<10
Uranium (U)	µg/L	<2	20	--	15	5	<2	<2	<2	<2	<2	<2	<2	<2	<2	<2	<2	<2	<2
Vanadium (V)	µg/L	<2	--	--	--	6	<2	<2	<2	<2	<2	<2	<2	<2	<2	<2	<2	<2	<2
Zinc (Zn)	µg/L	<5	--	--	30	20	6	<5	32	<5	24	20	<5	<5	<5	7	17	43	5
Zirconium (Zr)	µg/L	<4	--	--	--	4	<4	<4	<4	<4	<4	<4	<4	<4	<4	<4	<4	<4	<4
OTHER PARAMETERS																			
Total Cyanide	µg/L	<2	--	--	--	--	<2	<2	<2	<2	<2	<2	<2	<2	<2	<2	<2	<2	<2
Sulphur (S)	µg/L	<50	--	--	--	--	--	--	--	--	--	--	--	--	--	--	--	--	--
NUTRIENTS																			
Nitrate (NO ₃ ⁻)	µg/L as N	<50	10000	--	13000 ⁽²¹⁾	--	--	--	--	--	--	--	--	--	--	--	--	--	--
Nitrite (NO ₂ ⁻)	µg/L as N	<50	1000	--	60 ⁽²²⁾	--	--	--	--	--	--	--	--	--	--	--	--	--	--
Total Ammonia (NH ₃ + NH ₄)	µg/L as N	<20	--	--	6980	--	80	<20	<20	<20	<20	<20	<20	<20	<20	<20	<20	40	<20
Un-ionized Ammonia (NH ₃)	µg/L	--	--	--	19 ⁽²³⁾	20 ⁽²³⁾	0.072	<0.068	--	<0.068	<0.092	<0.092	<0.24	<0.04	<0.24	<0.022	0.104	0.0332	<0.164
Total Kjeldahl Nitrogen	µg/L	<100	--	--	--	--	--	--	--	--	--	--	--	--	--	--	--	--	--
Total Phosphorus (P)	µg/L	<20	--	--	20	20	<20	<20	20	<20	50	40	<20	30	<20	<20	<20	<20	<20
Phosphate (PO ₄)	µg/L as P	<100	--	--	--	--	--	--	--	--	--	--	--	--	--	--	--	--	--
Soluble Reactive Phosphorus	µg/L	<20	--	--	--	--	--	--	--	--	--	--	--	--	--	--	--	--	--
ORGANICS																			
Oil and Grease (Animal/Vegetable)	µg/L	<500	--	--	--	--	--	--	--	--	--	--	--	--	--	--	--	--	--
Oil and Grease (Mineral)	µg/L	<500	--	--	--	--	--	--	--	--	--	--	--	--	--	--	--	--	--
Oil and Grease (Total)	µg/L	<500	--	--	--	physically non detect	--	--	--	--	--	--	--	--	--	--	--	--	--
RADIONUCLIDES																			
Radium-226	Bq/L	<0.001	0.6	--	--	1 ⁽²⁴⁾	--	--	--	--	--	--	--	--	--	<0.001	<0.001	<0.001	<0.001

**APPENDIX A
2011-2013 Surface Water Quality Results**

Parameter ⁽¹⁾	Unit	Method Detection Limit	Ontario Drinking Water Standards ⁽²⁾⁽³⁾		Canadian Water Quality Guidelines ⁽⁴⁾	Provincial Water Quality Objective ⁽⁵⁾	3D-LS1 - Three Duck Lakes (Upper)		3D-LS2 - Three Duck Lakes (Lower)	
			MAC	IMAC			23-May-2013 (T)	23-May-2013 (B)	24-May-2013 (T)	24-May-2013 (B)
FIELD PARAMETERS										
pH	pH units	--	--	--	6.5-9	6.5-8.5	6.7	6.77	6.87	6.9
Temperature	degrees Celsius	--	--	--	--	-0.25	11.04	10.77	9.93	9.51
Conductivity	µS/cm	--	--	--	--	--	32	32	33	33
Dissolved Oxygen	µg/L	--	--	--	--	--	10660	10900	10350	10590
ORP	mV	--	--	--	--	--	147.9	143.0	123.4	103.4
GENERAL PARAMETERS										
pH	pH units	--	--	--	6.5-9	6.5-8.5	6.16	6.2	6.15	6.16
Alkalinity	µg/L as CaCO3	<5000	--	--	--	-25%	8000	9000	9000	9000
Acidity	µg/L as CaCO3	<5000	--	--	--	--	<5000	<5000	<5000	<5000
Electrical Conductivity (EC)	µS/cm	<2	--	--	--	--	34	35	36	36
Total Dissolved Solids (TDS)	µg/L	<20000	--	--	--	--	56000	46000	40000	58000
Total Suspended Solids (TSS)	µg/L	<1000, <10000	--	--	+5000-25000 ⁽⁶⁾	--	<10000	<10000	<10000	<10000
Total Hardness	µg/L as CaCO3	<500	--	--	--	--	17800	18100	18600	18500
Dissolved Organic Carbon (DOC)	µg/L	<500	--	--	--	--	14100	13400	13400	13600
Total Organic Carbon (TOC)	µg/L	<500	--	--	--	--	14300	14500	13700	14100
Chemical Oxygen Demand (COD)	µg/L	<5000	--	--	--	--	--	--	--	--
MAJOR IONS										
Calcium (Ca)	µg/L	<50	--	--	--	--	5530	5630	5760	5720
Magnesium (Mg)	µg/L	<50	--	--	--	--	970	980	1030	1030
Potassium (K)	µg/L	<50	--	--	--	--	420	420	440	470
Sodium (Na)	µg/L	<50	--	--	--	--	800	790	820	810
Chloride (Cl)	µg/L	<100	--	--	--	--	390	380	410	470
Fluoride (F)	µg/L	<50	1500 ⁽⁷⁾	--	--	--	<50	<50	<50	<50
Sulphate (SO ₄)	µg/L	<100	--	--	--	--	2880	2810	2810	2780
METALS										
Aluminum (Al)	µg/L	<4	--	--	100 ⁽⁸⁾	75 ⁽⁹⁾	98	99	95	101
Antimony (Sb)	µg/L	<6	--	6	--	20	<3	<3	<3	<3
Arsenic (As)	µg/L	<3	--	25	5	5	<3	<3	<3	<3
Barium (Ba)	µg/L	<2	1000	--	--	--	4	4	4	7
Beryllium (Be)	µg/L	<1	--	--	--	11 ⁽¹⁰⁾	<1	<1	<1	<1
Boron (B)	µg/L	<10	--	5000	1500 ⁽¹¹⁾	200	<10	<10	<10	<10
Cadmium (Cd)	µg/L	<0.1	--	5	0.058 ⁽¹²⁾	0.1 ⁽¹³⁾	<0.1	<0.1	<0.1	<0.1
Chromium (Cr)	µg/L	<3	50	--	8.9 ⁽¹⁴⁾	8.9 ⁽¹⁴⁾	<3	<3	<3	<3
Cobalt (Co)	µg/L	<0.5	--	--	--	0.9	<0.5	<0.5	<0.5	<0.5
Copper (Cu)	µg/L	<2	--	--	2 ⁽¹⁵⁾	5 ⁽¹⁶⁾	<2	<2	<2	<2
Iron (Fe)	µg/L	<10	--	--	300	300	140	150	140	230
Lead (Pb)	µg/L	<1	10 ⁽¹⁷⁾	--	1 ⁽¹⁸⁾	3 ⁽¹⁹⁾	<1	<1	<1	<1
Manganese (Mn)	µg/L	<2	--	--	--	--	25	26	27	41
Mercury (Hg)	µg/L	<0.10	1	--	0.026	0.2	<0.1	<0.1	<0.1	<0.1
Molybdenum (Mo)	µg/L	<2	--	--	73	40	<2	<2	<2	<2
Nickel (Ni)	µg/L	<3	--	--	25 ⁽²⁰⁾	25	<3	<3	<3	<3
Selenium (Se)	µg/L	<4	10	--	1	100	<4	<4	<4	<4
Silver (Ag)	µg/L	<0.1	--	--	0.1	0.1	<0.1	<0.1	<0.1	<0.1
Strontium (Sr)	µg/L	<5	--	--	--	--	9	10	10	24
Thallium (Tl)	µg/L	<0.3	--	--	0.8	0.3	<0.3	<0.3	<0.3	<0.3
Titanium (Ti)	µg/L	<2	--	--	--	--	<2	<2	<2	3
Tungsten (W)	µg/L	<10	--	--	--	30	<10	<10	<10	<10
Uranium (U)	µg/L	<2	20	--	15	5	<2	<2	<2	<2
Vanadium (V)	µg/L	<2	--	--	--	6	<2	<2	<2	<2
Zinc (Zn)	µg/L	<5	--	--	30	20	<5	10	<5	450
Zirconium (Zr)	µg/L	<4	--	--	--	4	<4	<4	<4	<4
OTHER PARAMETERS										
Total Cyanide	µg/L	<2	--	--	--	--	<2	<2	<2	21
Free Cyanide	µg/L	<2	--	--	5	5	<2	<2	<2	21
Phenols	µg/L	<1	--	--	--	5	<1	--	<1	--
Sulphur (S)	µg/L	<50	--	--	--	--	--	--	--	--
NUTRIENTS										
Nitrate (NO ₃ ⁻)	µg/L as N	<50	10000	--	13000 ⁽²¹⁾	--	<50	60	<50	60
Nitrite (NO ₂ ⁻)	µg/L as N	<50	1000	--	60 ⁽²²⁾	--	<50	<50	<50	<50
Total Ammonia (NH ₃)	µg/L as N	<20	--	--	6980	--	<20	<20	<20	<20
Un-ionized Ammonia (NH ₃)	µg/L	--	--	--	19 ⁽²³⁾	20 ⁽²³⁾	<0.027	<0.028	<0.027	<0.028
Total Kjeldahl Nitrogen	µg/L	<100	--	--	--	--	--	--	--	--
Total Phosphorus (TP)	µg/L	<20	--	--	20	20	<20	<20	<20	<20
Phosphate (PO ₄)	µg/L as P	<100	--	--	--	--	--	--	--	--
Soluble Reactive Phosphorus	µg/L	<20	--	--	--	--	--	--	--	--
ORGANICS										
Oil and Grease (Animal/Vegetable)	µg/L	<500	--	--	--	--	<500	--	<500	--
Oil and Grease (Mineral)	µg/L	<500	--	--	--	--	<500	--	<500	--
Oil and Grease (Total)	µg/L	<500	--	--	--	physically non detect	<500	--	<500	--
Polychlorinated Biphenyls	µg/L	<0.1	--	0.003	--	0.001	<0.1	--	<0.1	--
Naphthalene	µg/L	<0.2	--	--	1.1	7	<0.2	--	<0.2	--
Acenaphthylene	µg/L	<0.2	--	--	--	--	<0.2	--	<0.2	--
Acenaphthene	µg/L	<0.2	--	--	5.8	--	<0.2	--	<0.2	--
Fluorene	µg/L	<0.2	--	--	3	0.2	<0.2	--	<0.2	--
Phenanthrene	µg/L	<0.1	--	--	0.4	0.03	<0.1	--	<0.1	--
Anthracene	µg/L	<0.1	--	--	0.012	0.0008	<0.1	--	<0.1	--
Fluoranthene	µg/L	<0.2	--	--	0.04	0.0008	<0.2	--	<0.2	--
Pyrene	µg/L	<0.2	--	--	0.025	--	<0.2	--	<0.2	--
Benzo(a)anthracene	µg/L	<0.2	--	--	0.018	0.0004	<0.2	--	<0.2	--
Chrysene	µg/L	<0.1	--	--	--	0.0001	<0.1	--	<0.1	--
Benzo(b)fluoranthene	µg/L	<0.1	--	--	--	--	<0.1	--	<0.1	--
Benzo(k)fluoranthene	µg/L	<0.1	--	--	--	0.0002	<0.1	--	<0.1	--
Benzo(a)pyrene	µg/L	<0.01	--	--	0.015	--	<0.01	--	<0.01	--
Indeno(1,2,3-cd)pyrene	µg/L	<0.2	--	--	--	--	<0.2	--	<0.2	--
Dibenz(a,h)anthracene	µg/L	<0.2	--	--	--	0.002	<0.2	--	<0.2	--
Benzo(g,h,i)perylene	µg/L	<0.2	--	--	--	0.00002	<0.2	--	<0.2	--
2-and 1-methyl Naphthalene	µg/L	<0.2	--	--	--	--	<0.2	--	<0.2	--
RADIONUCLIDES										
Radium-226	Bq/L	<0.001	0.6	--	--	1 ⁽²⁴⁾	--	--	--	--
MICROBIOLOGICAL										
Escherichia coli	CFU/100mL	1	--	--	--	100	3	--	2	--
Total Coliforms	CFU/100mL	1	--	--	--	--	80	--	57	--

2011-2013 Surface Water Quality Results

Parameter ⁽¹⁾	Unit	Method Detection Limit	Ontario Drinking Water Standards ⁽²⁾⁽³⁾		Canadian Water Quality Guidelines ⁽⁴⁾	Provincial Water Quality Objective ⁽⁵⁾	DEL-LS - Delaney Lake
			MAC	IMAC			29-May-2013 (T)
FIELD PARAMETERS							
pH	pH units	--	--	--	6.5-9	6.5-8.5	6.26
Temperature	degrees Celsius	--	--	--	--	-0.25	16.08
Conductivity	µS/cm	--	--	--	--	--	25
Dissolved Oxygen	µg/L	--	--	--	--	--	9890
ORP	mV	--	--	--	--	--	--
GENERAL PARAMETERS							
pH	pH units	--	--	--	6.5-9	6.5-8.5	6.53
Alkalinity	µg/L as CaCO ₃	<5000	--	--	--	-25%	7000
Acidity	µg/L as CaCO ₃	<5000	--	--	--	--	<5000
Electrical Conductivity (EC)	µS/cm	<2	--	--	--	--	25
Total Dissolved Solids (TDS)	µg/L	<20000	--	--	--	--	58000
Total Suspended Solids (TSS)	µg/L	<1000, <10000	--	--	+5000-25000 ⁽⁶⁾	--	<10000
Total Hardness	µg/L as CaCO ₃	<500	--	--	--	--	14800
Dissolved Organic Carbon (DOC)	µg/L	<500	--	--	--	--	17300
Total Organic Carbon (TOC)	µg/L	<500	--	--	--	--	19100
Chemical Oxygen Demand (COD)	µg/L	<5000	--	--	--	--	--
MAJOR IONS							
Calcium (Ca)	µg/L	<50	--	--	--	--	4470
Magnesium (Mg)	µg/L	<50	--	--	--	--	880
Potassium (K)	µg/L	<50	--	--	--	--	310
Sodium (Na)	µg/L	<50	--	--	--	--	670
Chloride (Cl)	µg/L	<100	--	--	--	--	250
Fluoride (F)	µg/L	<50	1500 ⁽⁷⁾	--	--	--	<50
Sulphate (SO ₄)	µg/L	<100	--	--	--	--	2240
METALS							
Aluminum (Al)	µg/L	<4	--	--	100 ⁽⁸⁾	75 ⁽⁹⁾	137
Antimony (Sb)	µg/L	<6	--	6	--	20	<3
Arsenic (As)	µg/L	<3	--	25	5	5	<3
Barium (Ba)	µg/L	<2	1000	--	--	--	4
Beryllium (Be)	µg/L	<1	--	--	--	11 ⁽¹⁰⁾	<1
Boron (B)	µg/L	<10	--	5000	1500 ⁽¹¹⁾	200	<10
Cadmium (Cd)	µg/L	<0.1	--	5	0.058 ⁽¹²⁾	0.1 ⁽¹³⁾	<0.1
Chromium (Cr)	µg/L	<3	50	--	8.9 ⁽¹⁴⁾	8.9 ⁽¹⁴⁾	<3
Cobalt (Co)	µg/L	<0.5	--	--	--	0.9	<0.5
Copper (Cu)	µg/L	<2	--	--	2 ⁽¹⁵⁾	5 ⁽¹⁶⁾	<2
Iron (Fe)	µg/L	<10	--	--	300	300	110
Lead (Pb)	µg/L	<1	10 ⁽¹⁷⁾	--	1 ⁽¹⁸⁾	3 ⁽¹⁹⁾	<1
Manganese (Mn)	µg/L	<2	--	--	--	--	15
Mercury (Hg)	µg/L	<0.10	1	--	0.026	0.2	<0.1
Molybdenum (Mo)	µg/L	<2	--	--	73	40	<2
Nickel (Ni)	µg/L	<3	--	--	25 ⁽²⁰⁾	25	<3
Selenium (Se)	µg/L	<4	10	--	1	100	<4
Silver (Ag)	µg/L	<0.1	--	--	0.1	0.1	<0.1
Strontium (Sr)	µg/L	<5	--	--	--	--	13
Thallium (Tl)	µg/L	<0.3	--	--	0.8	0.3	<0.3
Titanium (Ti)	µg/L	<2	--	--	--	--	2
Tungsten (W)	µg/L	<10	--	--	--	30	<10
Uranium (U)	µg/L	<2	20	--	15	5	<2
Vanadium (V)	µg/L	<2	--	--	--	6	<2
Zinc (Zn)	µg/L	<5	--	--	30	20	23
Zirconium (Zr)	µg/L	<4	--	--	--	4	<4
OTHER PARAMETERS							
Total Cyanide	µg/L	<2	--	--	--	--	<2
Free Cyanide	µg/L	<2	--	--	5	5	<2
Phenols	µg/L	<1	--	--	--	5	--
Sulphur (S)	µg/L	<50	--	--	--	--	<2
NUTRIENTS							
Nitrate (NO ₃ ⁻)	µg/L as N	<50	10000	--	13000 ⁽²¹⁾	--	<50
Nitrite (NO ₂ ⁻)	µg/L as N	<50	1000	--	60 ⁽²²⁾	--	<50
Total Ammonia (NH ₃)	µg/L as N	<20	--	--	6980	--	<20
Un-ionized Ammonia (NH ₃)	µg/L	--	--	--	19 ⁽²³⁾	20 ⁽²³⁾	<0.011
Total Kjeldahl Nitrogen	µg/L	<100	--	--	--	--	--
Total Phosphorus (TP)	µg/L	<20	--	--	20	20	<20
Phosphate (PO ₄)	µg/L as P	<100	--	--	--	--	--
Soluble Reactive Phosphorus	µg/L	<20	--	--	--	--	--
ORGANICS							
Oil and Grease (Animal/Vegetable)	µg/L	<500	--	--	--	--	--
Oil and Grease (Mineral)	µg/L	<500	--	--	--	--	--
Oil and Grease (Total)	µg/L	<500	--	--	--	physically non detect	--
RADIONUCLIDES							
Radium-226	Bq/L	<0.001	0.6	--	--	1 ⁽²⁴⁾	--

APPENDIX A
2011-2013 Surface Water Quality Results

Parameter ⁽¹⁾	Unit	Method Detection Limit	Ontario Drinking Water Standards ⁽²⁾⁽³⁾		Canadian Water Quality Guidelines ⁽⁴⁾	Provincial Water Quality Objective ⁽⁵⁾	DIV-LS - Dividing Lake	
			MAC	IMAC			23-May-2013 (T)	23-May-2013 (B)
FIELD PARAMETERS								
pH	pH units	--	--	--	6.5-9	6.5-8.5	7.19	7.34
Temperature	degrees Celsius	--	--	--	--	-0.25	9.22	3.82
Conductivity	µS/cm	--	--	--	--	--	55	103
Dissolved Oxygen	µg/L	--	--	--	--	--	10700	13190
GENERAL PARAMETERS								
pH	pH units	--	--	--	6.5-9	6.5-8.5	6.63	7.17
Alkalinity	µg/L as CaCO ₃	<5000	--	--	--	-25%	18000	41000
Acidity	µg/L as CaCO ₃	<5000	--	--	--	--	<5000	<5000
Electrical Conductivity (EC)	µS/cm	<2	--	--	--	--	60	115
Total Dissolved Solids (TDS)	µg/L	<20000	--	--	--	--	60000	84000
Total Suspended Solids (TSS)	µg/L	<1000, <10000	--	--	+5000-25000 ⁽⁶⁾	--	<10000	<10000
Total Hardness	µg/L as CaCO ₃	<500	--	--	--	--	30600	53800
Dissolved Organic Carbon (DOC)	µg/L	<500	--	--	--	--	12900	8500
Total Organic Carbon (TOC)	µg/L	<500	--	--	--	--	13600	8600
Chemical Oxygen Demand (COD)	µg/L	<5000	--	--	--	--	--	--
MAJOR IONS								
Calcium (Ca)	µg/L	<50	--	--	--	--	9410	16600
Magnesium (Mg)	µg/L	<50	--	--	--	--	1730	3000
Potassium (K)	µg/L	<50	--	--	--	--	490	660
Sodium (Na)	µg/L	<50	--	--	--	--	1720	3180
Chloride (Cl)	µg/L	<100	--	--	--	--	2360	5830
Fluoride (F)	µg/L	<50	1500 ⁽⁷⁾	--	--	--	<50	<50
Sulphate (SO ₄)	µg/L	<100	--	--	--	--	3120	4080
METALS								
Aluminum (Al)	µg/L	<4	--	--	100 ⁽⁸⁾	75 ⁽⁹⁾	<u>79</u>	22
Antimony (Sb)	µg/L	<6	--	6	--	20	<3	<3
Arsenic (As)	µg/L	<3	--	25	5	5	<3	<3
Barium (Ba)	µg/L	<2	1000	--	--	--	4	4
Beryllium (Be)	µg/L	<1	--	--	--	11 ⁽¹⁰⁾	<1	<1
Boron (B)	µg/L	<10	--	5000	1500 ⁽¹¹⁾	200	<10	<10
Cadmium (Cd)	µg/L	<0.1	--	5	0.058 ⁽¹²⁾	0.1 ⁽¹³⁾	<0.1	<0.1
Chromium (Cr)	µg/L	<3	50	--	8.9 ⁽¹⁴⁾	8.9 ⁽¹⁴⁾	<3	<3
Cobalt (Co)	µg/L	<0.5	--	--	--	0.9	<0.5	<0.5
Copper (Cu)	µg/L	<2	--	--	2 ⁽¹⁵⁾	5 ⁽¹⁶⁾	<2	<2
Iron (Fe)	µg/L	<10	--	--	300	300	120	50
Lead (Pb)	µg/L	<1	10 ⁽¹⁷⁾	--	1 ⁽¹⁸⁾	3 ⁽¹⁹⁾	<1	<1
Manganese (Mn)	µg/L	<2	--	--	--	--	25	370
Mercury (Hg)	µg/L	<0.10	1	--	0.026	0.2	<0.1	<0.1
Molybdenum (Mo)	µg/L	<2	--	--	73	40	<2	<2
Nickel (Ni)	µg/L	<3	--	--	25 ⁽²⁰⁾	25	<3	<3
Selenium (Se)	µg/L	<4	10	--	1	100	<4	<4
Silver (Ag)	µg/L	<0.1	--	--	0.1	0.1	<0.1	<0.1
Strontium (Sr)	µg/L	<5	--	--	--	--	13	20
Thallium (Tl)	µg/L	<0.3	--	--	0.8	0.3	<0.3	<0.3
Titanium (Ti)	µg/L	<2	--	--	--	--	<2	<2
Tungsten (W)	µg/L	<10	--	--	--	30	<10	<10
Uranium (U)	µg/L	<2	20	--	15	5	<2	<2
Vanadium (V)	µg/L	<2	--	--	--	6	<2	<2
Zinc (Zn)	µg/L	<5	--	--	30	20	9	31
Zirconium (Zr)	µg/L	<4	--	--	--	4	<4	<4
OTHER PARAMETERS								
Total Cyanide	µg/L	<2	--	--	--	--	<2	<2
Free Cyanide	µg/L	<2	--	--	--	--	<2	<2
Phenols	µg/L	<1	--	--	--	--	--	--
Sulphur (S)	µg/L	<50	--	--	--	--	<2	<2
NUTRIENTS								
Nitrate (NO ₃ ⁻)	µg/L as N	<50	10000	--	13000 ⁽²³⁾	--	60	140
Nitrite (NO ₂ ⁻)	µg/L as N	<50	10000	--	13000 ⁽²¹⁾	--	<50	<50
Total Ammonia (NH ₃)	µg/L as N	<20	1000	--	60 ⁽²²⁾	--	<20	<20
Un-ionized Ammonia (NH ₃)	µg/L	--	--	--	6980	--	<0.054	<0.049
Total Kjeldahl Nitrogen	µg/L	<100	--	--	19 ⁽²³⁾	20 ⁽²³⁾	--	--
Total Phosphorus (TP)	µg/L	<20	--	--	--	--	<20	<20
Phosphate (PO ₄)	µg/L as P	<100	--	--	20	20	--	--
Soluble Reactive Phosphorus	µg/L	<20	--	--	--	--	--	--
ORGANICS								
Oil and Grease (Animal/Vegetable)	µg/L	<500	--	--	--	--	--	--
Oil and Grease (Mineral)	µg/L	<500	--	--	--	--	--	--
Oil and Grease (Total)	µg/L	<500	--	--	--	physically non detect	--	--
RADIONUCLIDES								
Radium-226	Bq/L	<0.001	0.6	--	--	1 ⁽²⁶⁾	--	--

NOTES ON COMPARISONS TO WATER QUALITY STANDARDS AND GUIDELINES:

Values in GREY exceed the ODWSs MACs or IMACs

Values in ***bold italics*** exceed the CCME CWQGs

Values underlined exceed the PWQOs

-- indicates no value available

NOTES ON WATER QUALITY STANDARDS AND GUIDELINES:

(1) Total concentrations are assumed, unless stated otherwise.

(2) Ontario Regulation (O.Reg.) 169/03: Ontario Drinking Water Standards (ODWS). Last amendment: O.Reg. 327/08.

http://www.e-laws.gov.on.ca/html/regs/english/elaws_regs_030169_e.htm.

(3) MAC: Maximum Acceptable Concentration; IMAC: Interim Maximum Acceptable Concentration

(4) Canadian Council of Ministers of the Environment (CCME), Canadian Water Quality Guidelines (CWQGs) for the Protection of Aquatic Life, Update 7.1 (December 2007).

(5) Provincial Water Quality Objectives, Ministry of Environment and Energy (1994, Revised 1999).

(6) TSS (CWQG) Under clear flow: + 25 mg/L from background levels for any short-term exposure (e.g., 24-h period).

average + 5 mg/L from background levels for longer term exposures (24 h < discharge < 30 d).

TSS (CWQG) Under high flow: + 25 mg/L from background levels at any time when background levels between 25 and 250 mg/L.

+ 10% of background levels when background is >250 mg/L.

(7) Where fluoride is added to drinking water, it is recommended that the concentration be adjusted to 0.5-0.8 mg/L the optimum level for control of tooth decay. Where supplies contain naturally occurring fluoride at levels higher than 1.5 mg/L but less than 2.4 mg/L the Ministry of Health and Long Term Care recommends an approach through local boards of health to raise public and professional awareness to control excessive exposure to fluoride from other sources.

(8) Aluminium guideline (CWQG) is calculated assuming a pH of 7.0.

(9) Aluminium guideline (PWQO) is calculated assuming a pH of 7.0.

(10) Beryllium guideline (PWQO) is calculated assuming a hardness of 30 mg/L as CaCO₃.

(11) Boron guideline (CWQG) is based on long-term exposure.

(12) Cadmium guideline (CWQG) is based on the Draft Scientific Criteria Document for the Development of the Canadian Water Quality Guidelines for the Protection of Aquatic Life: Cadmium, October 2012, and calculated using an assumed hardness of 30 mg/L as CaCO₃.

(13) Cadmium guideline (PWQO) is calculated assuming a hardness of 30 mg/L as CaCO₃.

(14) No guidelines for total chromium. Guidelines for trivalent chromium used: CWQG and PWQO guidelines for Cr(III) are both 8.9 µg/L.

(15) Copper guideline (CWQG) is calculated assuming a hardness of 30 mg/L as CaCO₃.

(16) Copper guideline (PWQO) is calculated assuming a hardness of 30 mg/L as CaCO₃.

(17) This standard applies to water at the point of consumption. Since lead is a component in some plumbing systems, first flush water may contain higher concentrations of lead than water that has been flushed for five minutes.

(18) Lead guideline (CWQG) is calculated assuming a hardness of 30 mg/L as CaCO₃.

(19) Lead guideline (PWQO) is calculated assuming a hardness of 30 mg/L as CaCO₃.

(20) Nickel guideline (CCME) is calculated assuming a hardness of 30 mg/L as CaCO₃.

(21) For protection from direct toxic effects, the guidelines do not consider indirect effects due to eutrophication.

(22) Guideline is expressed as µg nitrite-nitrogen/L. This value is equivalent to 197 µg nitrite/L.

(23) Un-ionized ammonia is calculated using the equation: $f = 1/(10^{pKa-pH} + 1)$, where f is the fraction of NH₃; $pKa = 0.09018 + 2729.92/T$; T = ambient water temperature in Kelvin ($K = °C + 273.16$) (Emerson et al., 1975)

(24) The PWQO for Ra-226 is based on drinking water requirements, which are derived from dose-response relationships as recommended by the International Commission on Radiological Protection (ICRP) in Publication 26.



APPENDIX B

Water Column Profile Plots

Water Column Profile Plots - Bagsverd Lake (BAG-LS1)

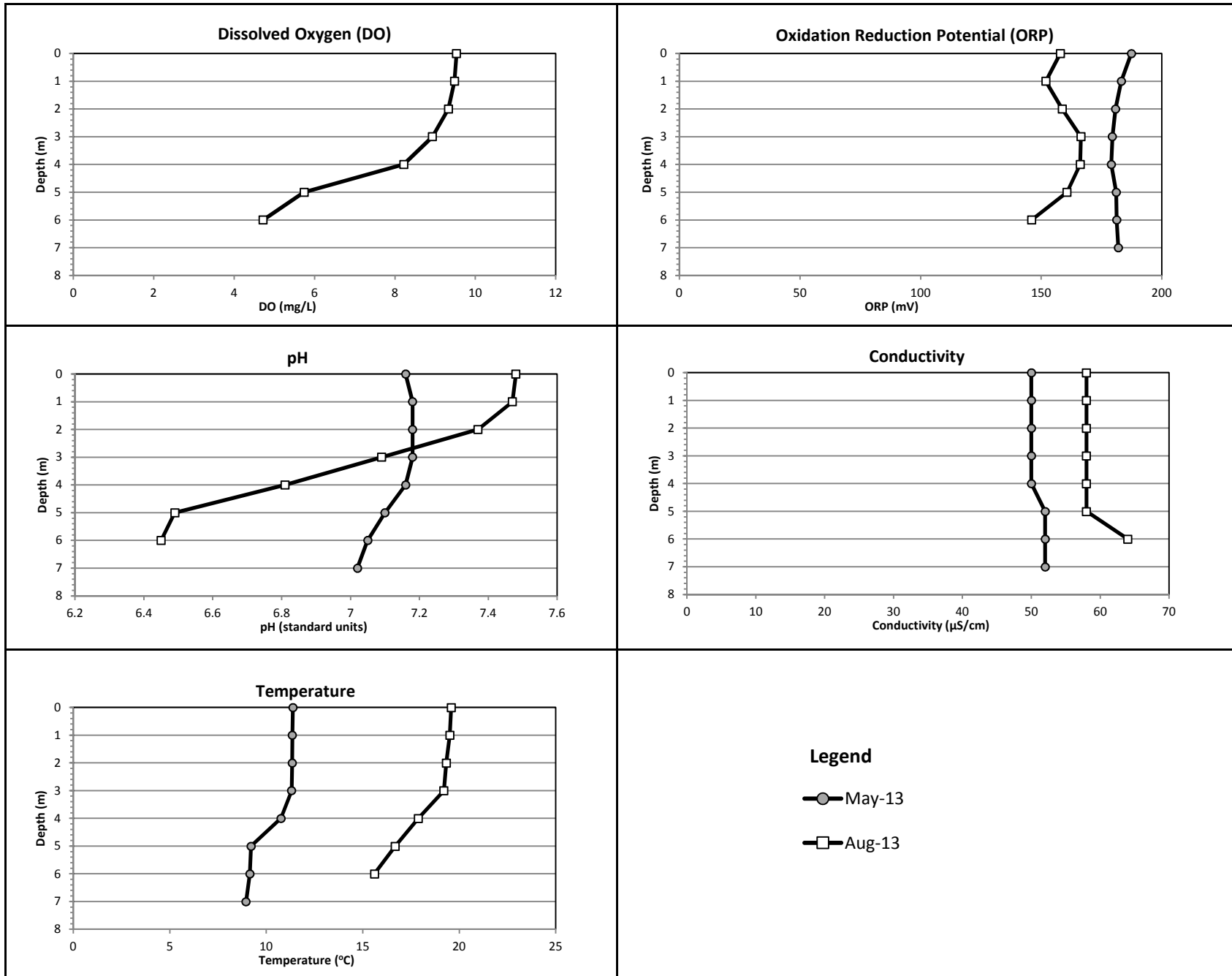

Water Column Profile Plots - Bagsverd Lake (BAG-LS2)

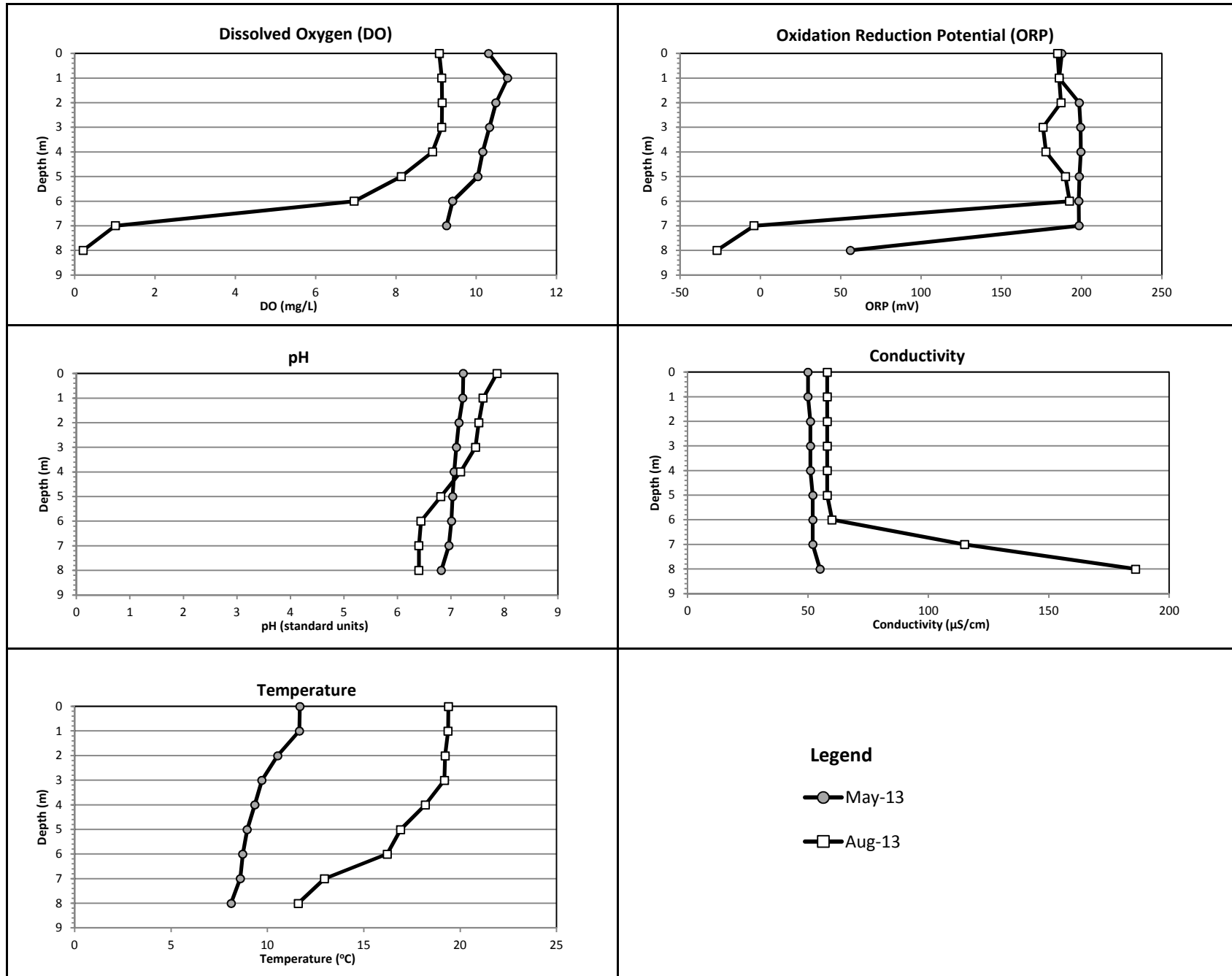

Water Column Profile Plots - Chester Lake (CHLK-LS)

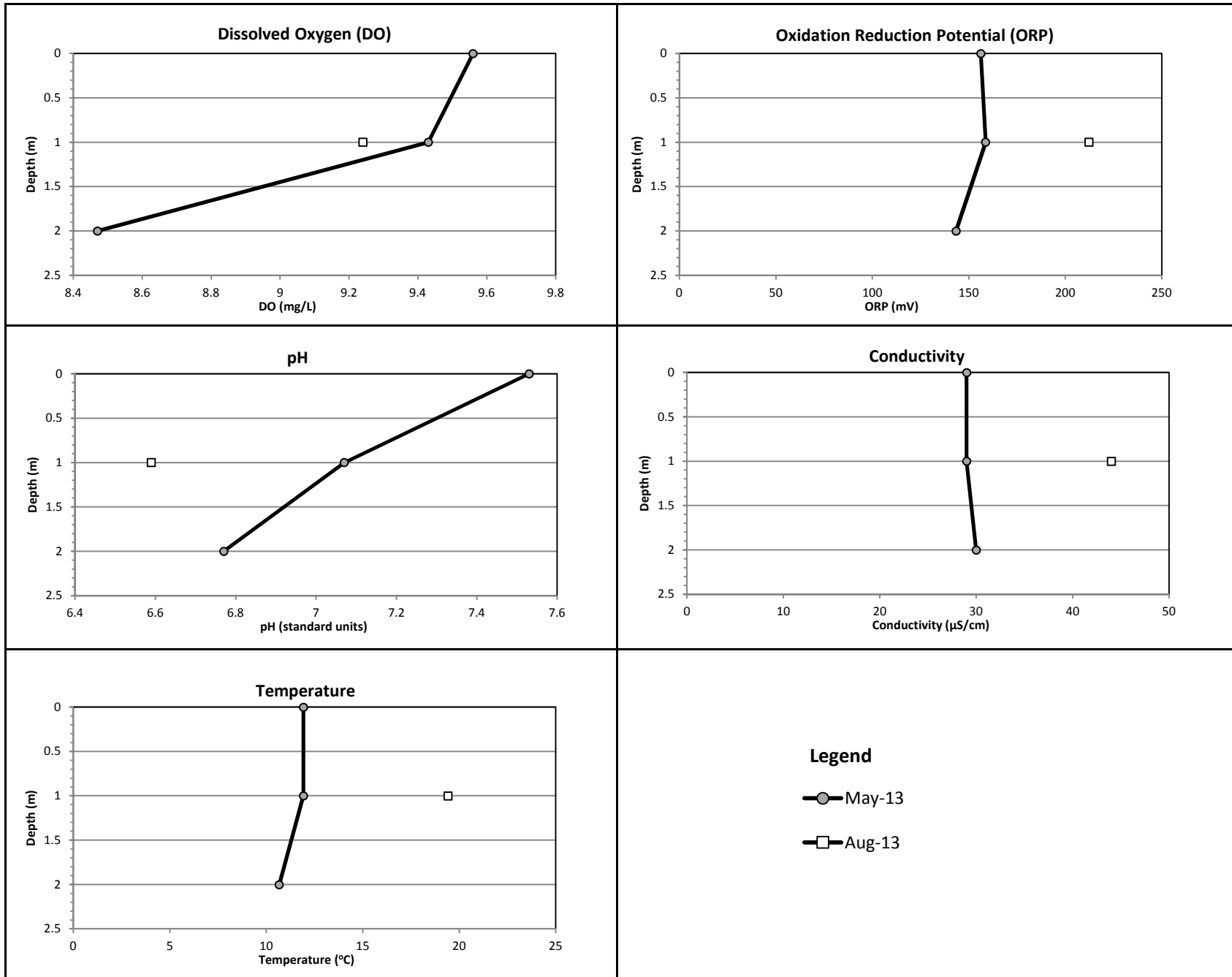

Water Column Profile Plots - Clam Lake (CM-LS1)

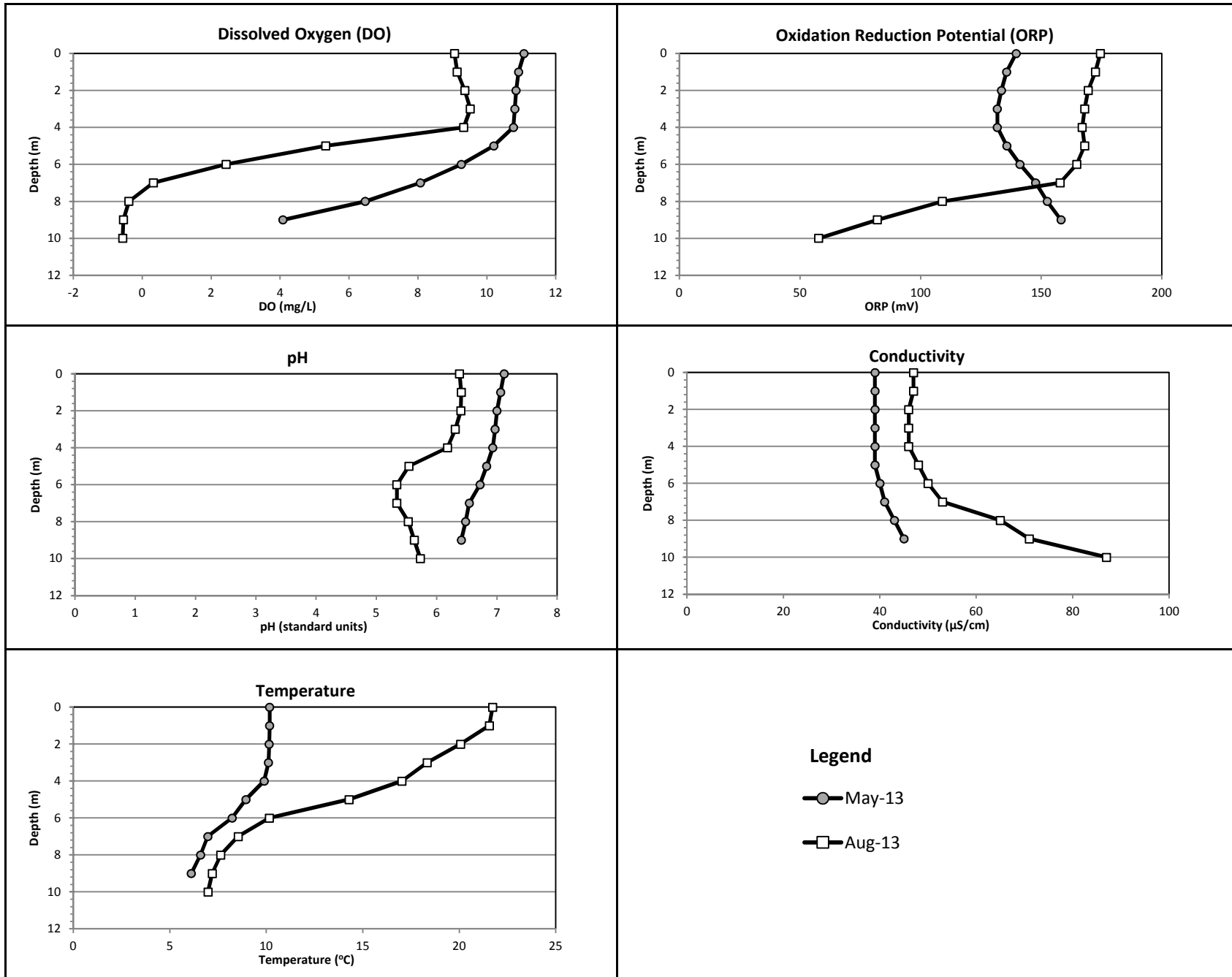

Water Column Profile Plots - Clam Lake (CM-LS2)

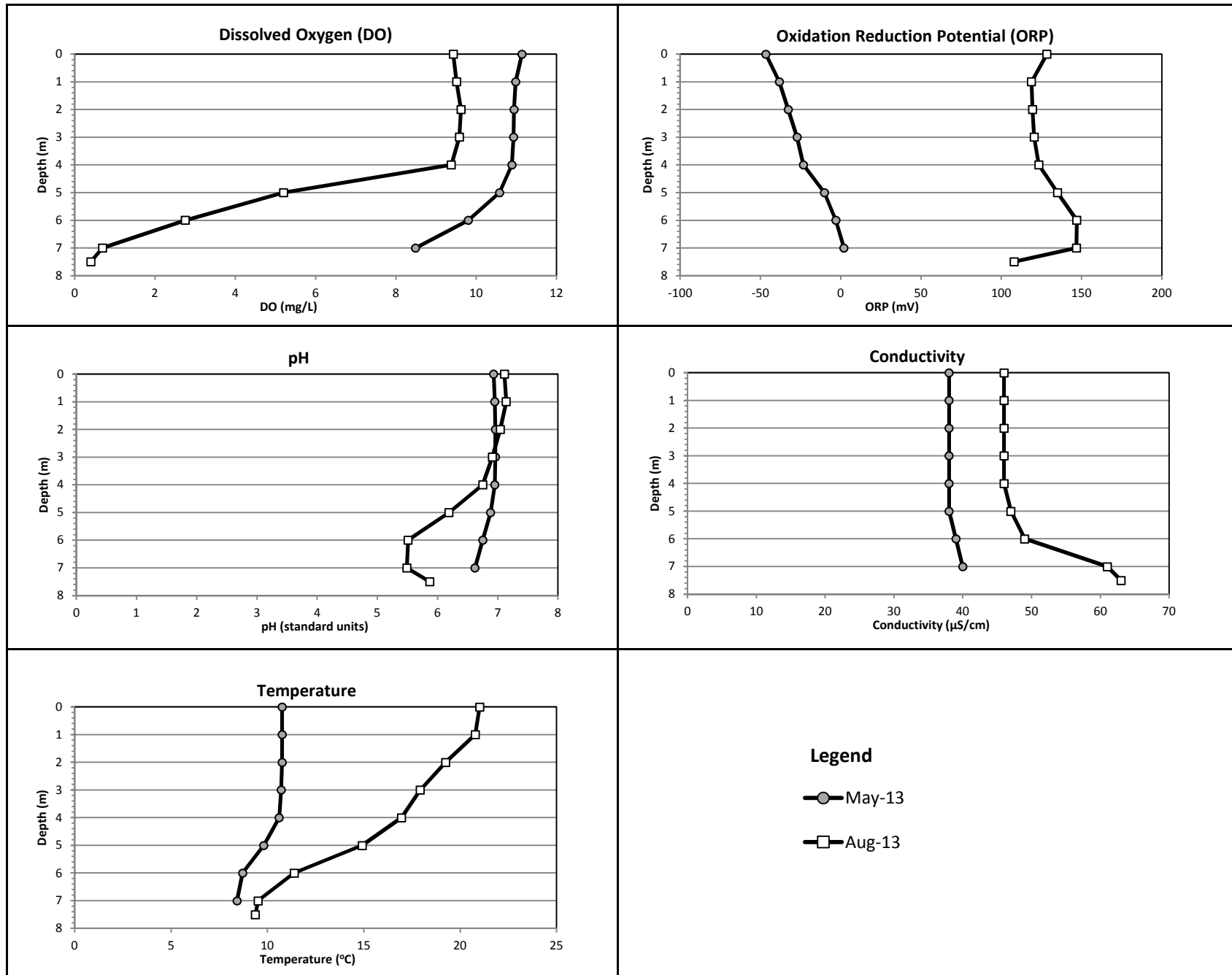

Water Column Profile Plots - Delaney Lake (DEL-LS)

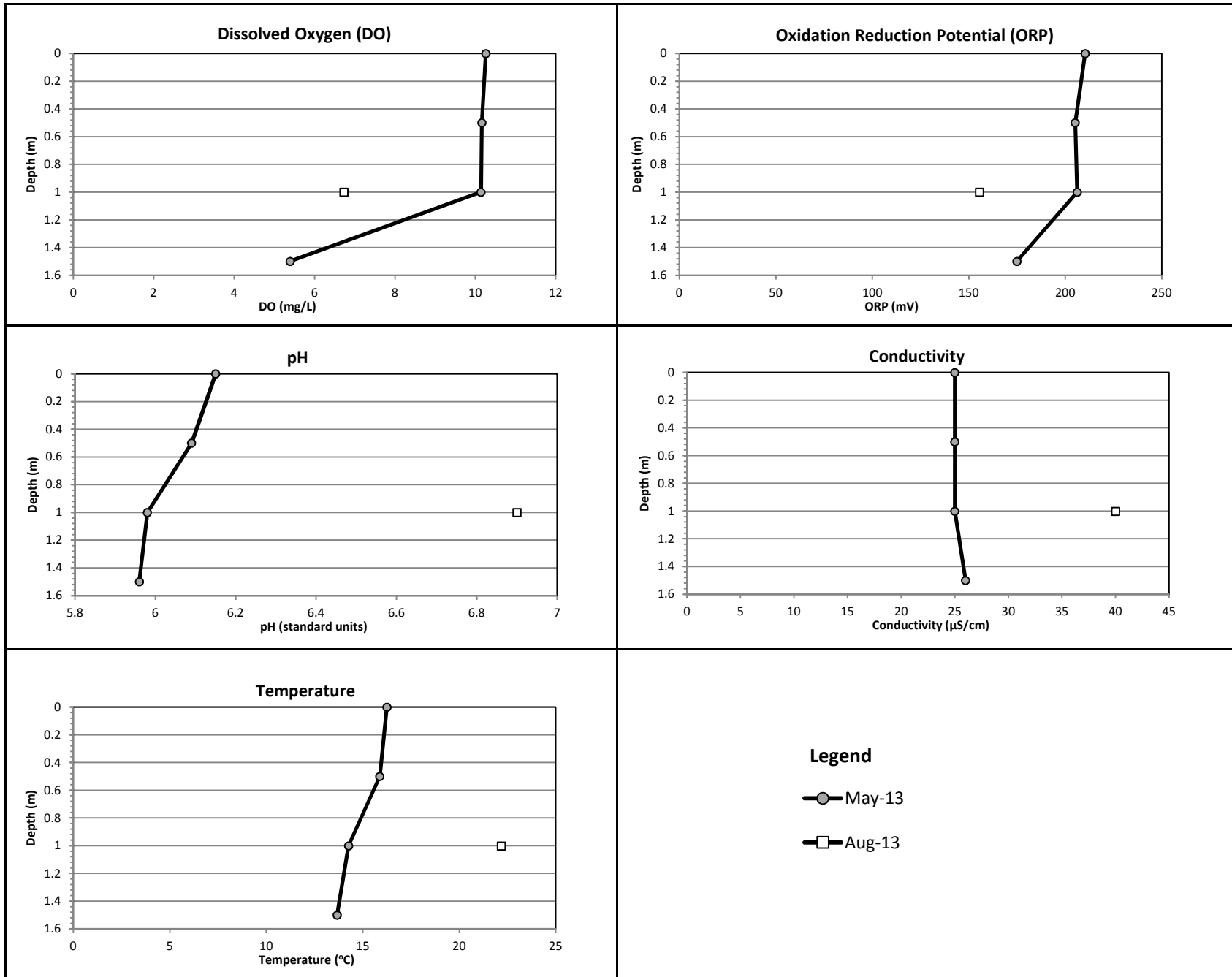

Water Column Profile Plots - Dividing Lake (DIV-LS1)

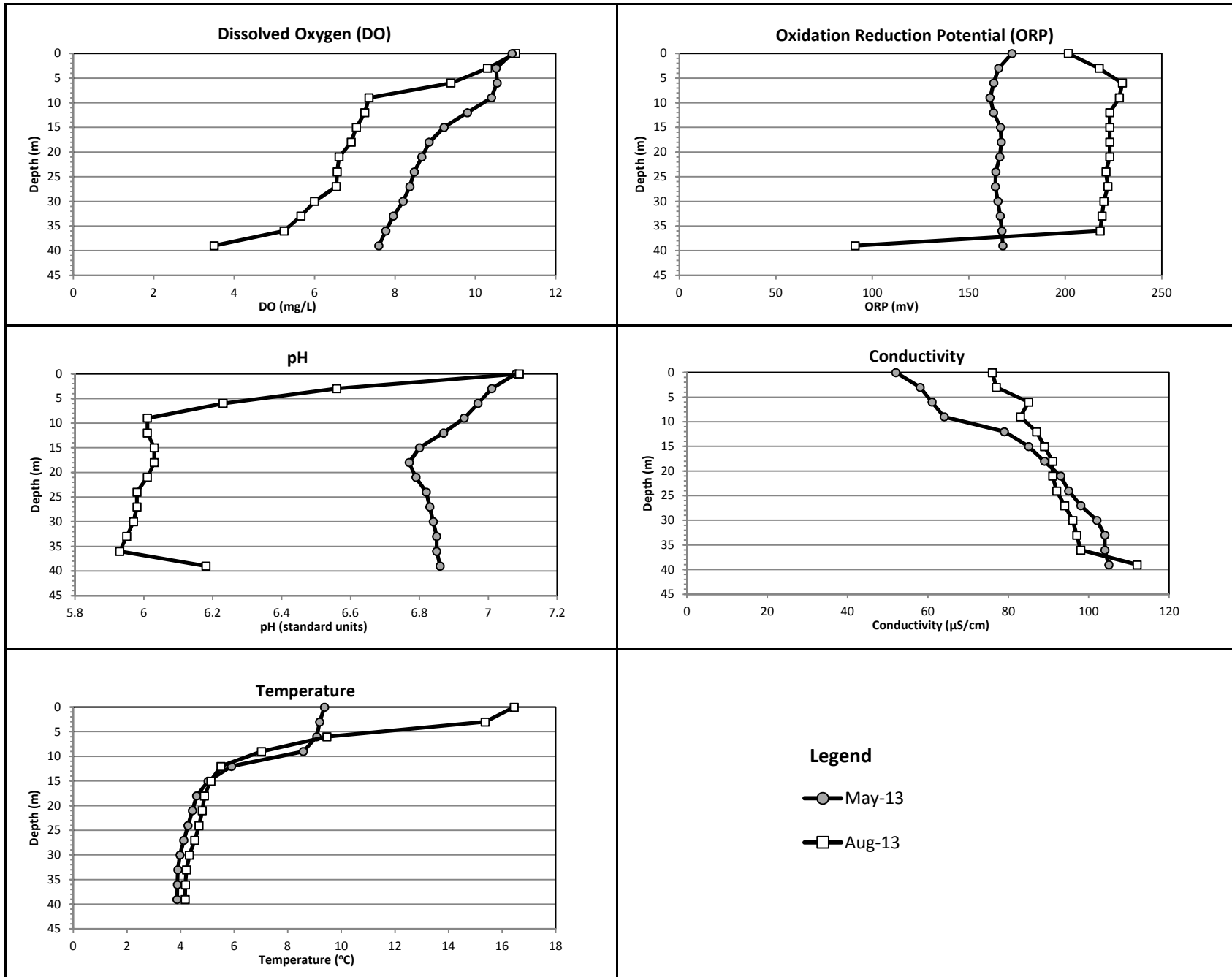

Water Column Profile Plots - Mesomikenda Lake (MESO-LS1)

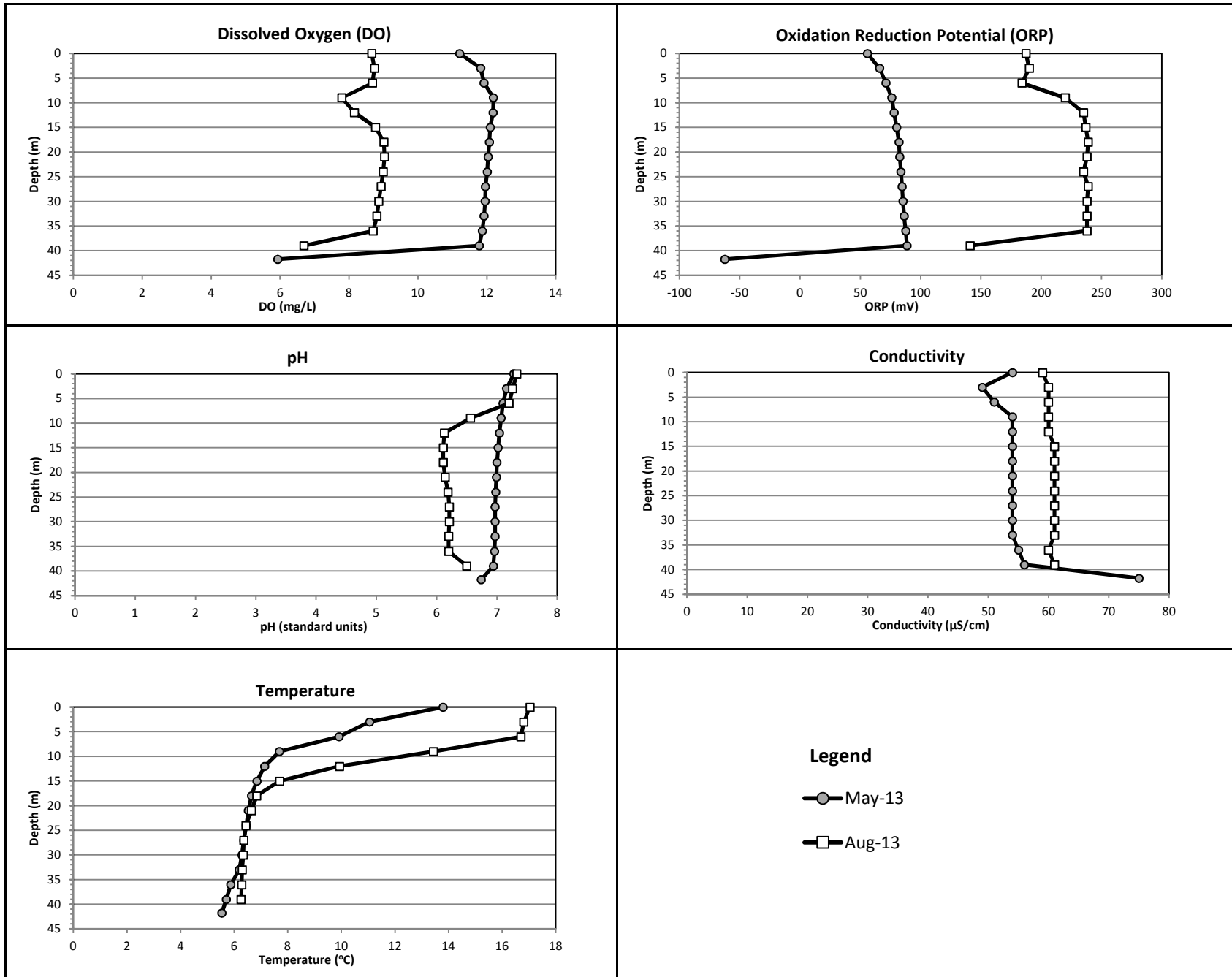

Water Column Profile Plots - Mesomikenda Lake (MESO-LS2)

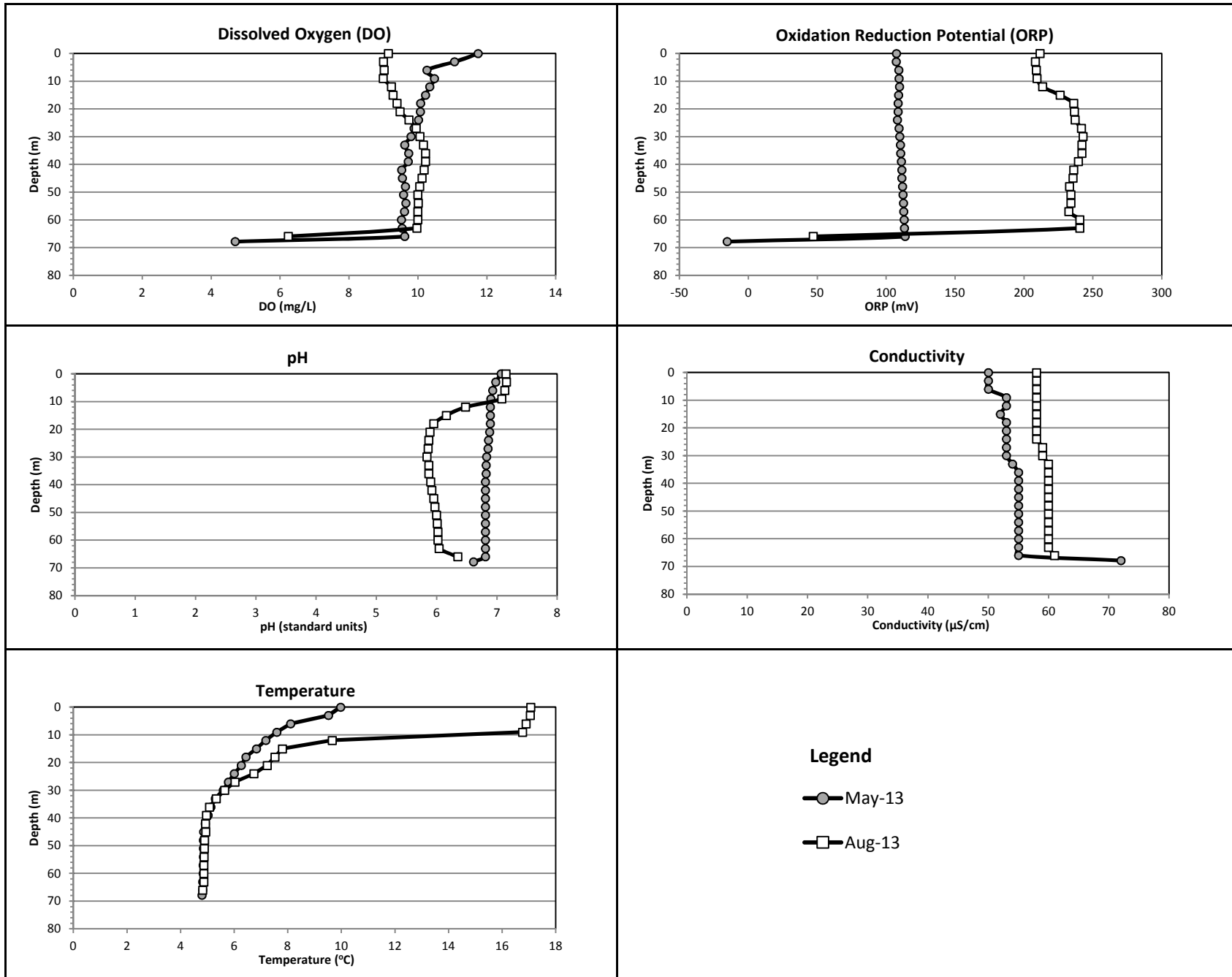

Water Column Profile Plots - Mesomikenda Lake (MESO-LS3)

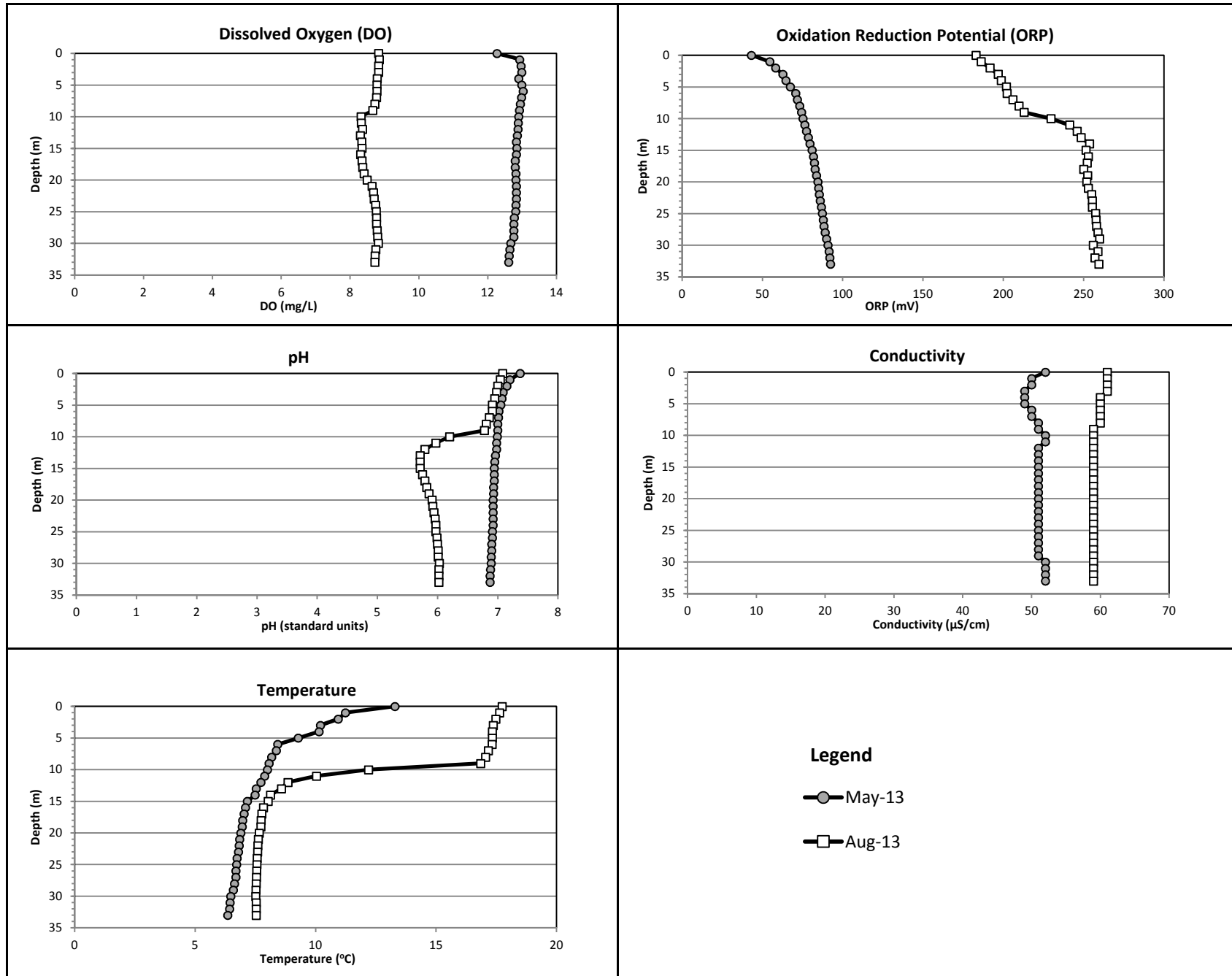

Water Column Profile Plots - Mesomikenda Lake (MESO-LS4)

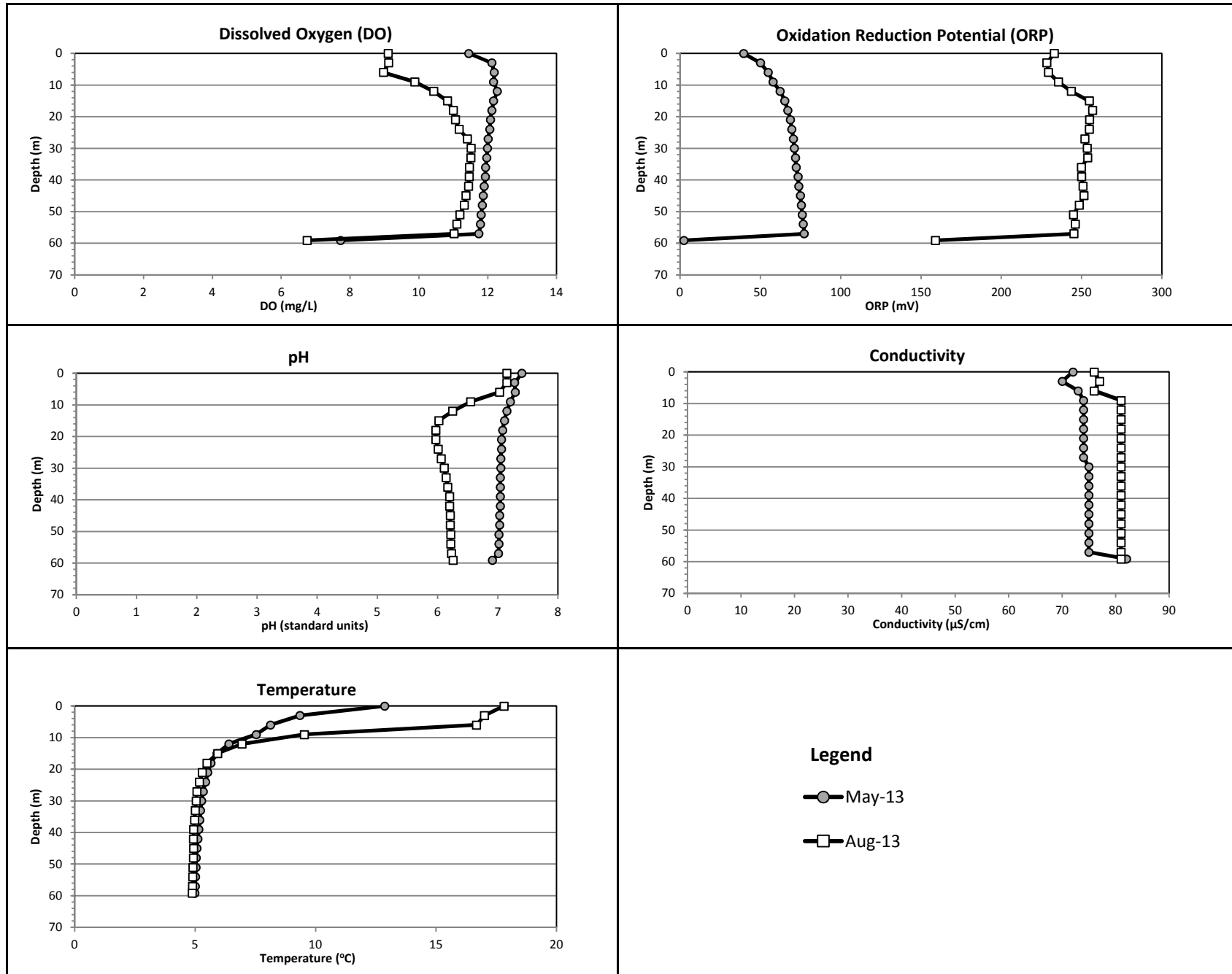

Water Column Profile Plots - Mesomikenda Lake (MESO-LS5)

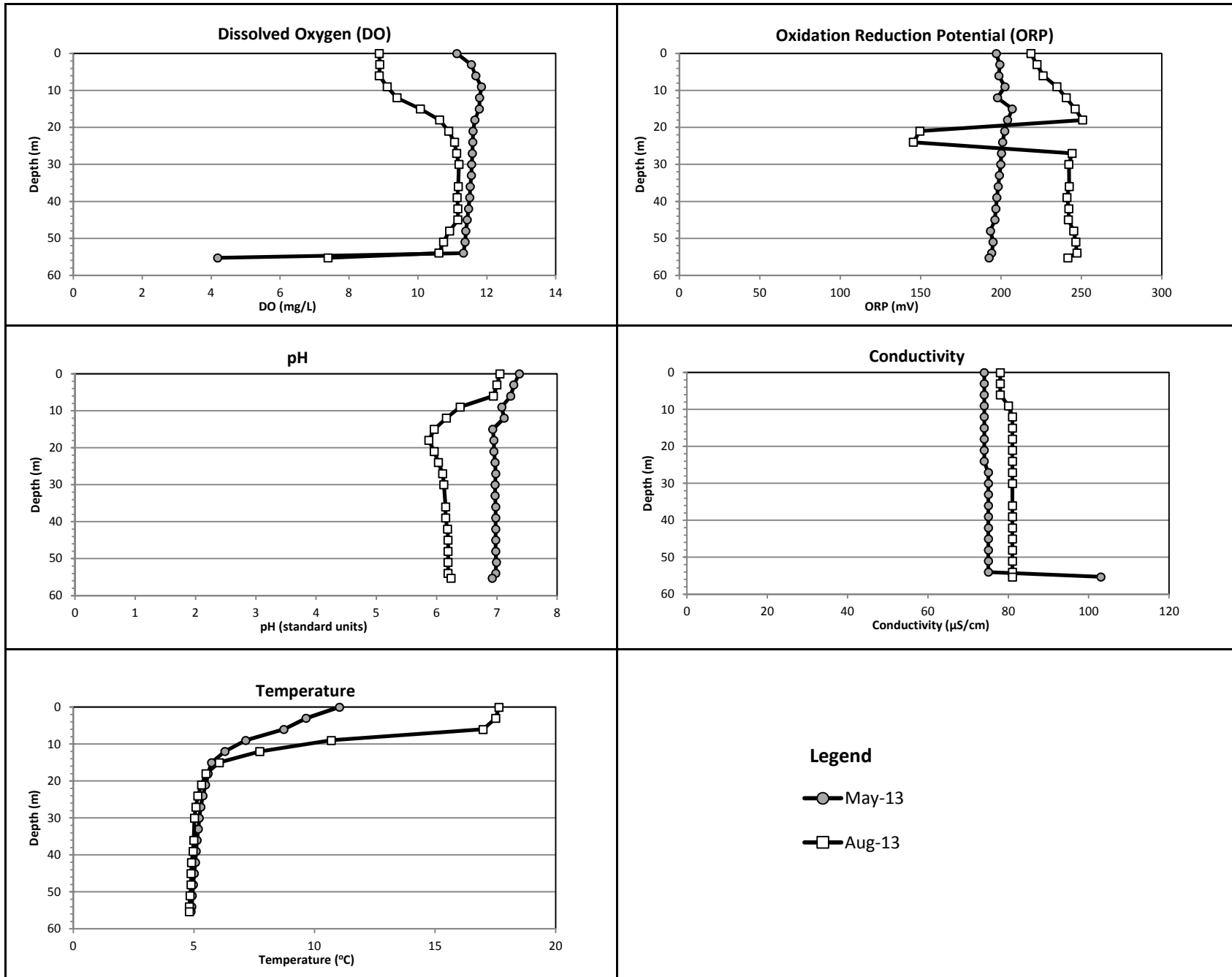

Water Column Profile Plots - Mesomikenda Lake (MESO-LS6)

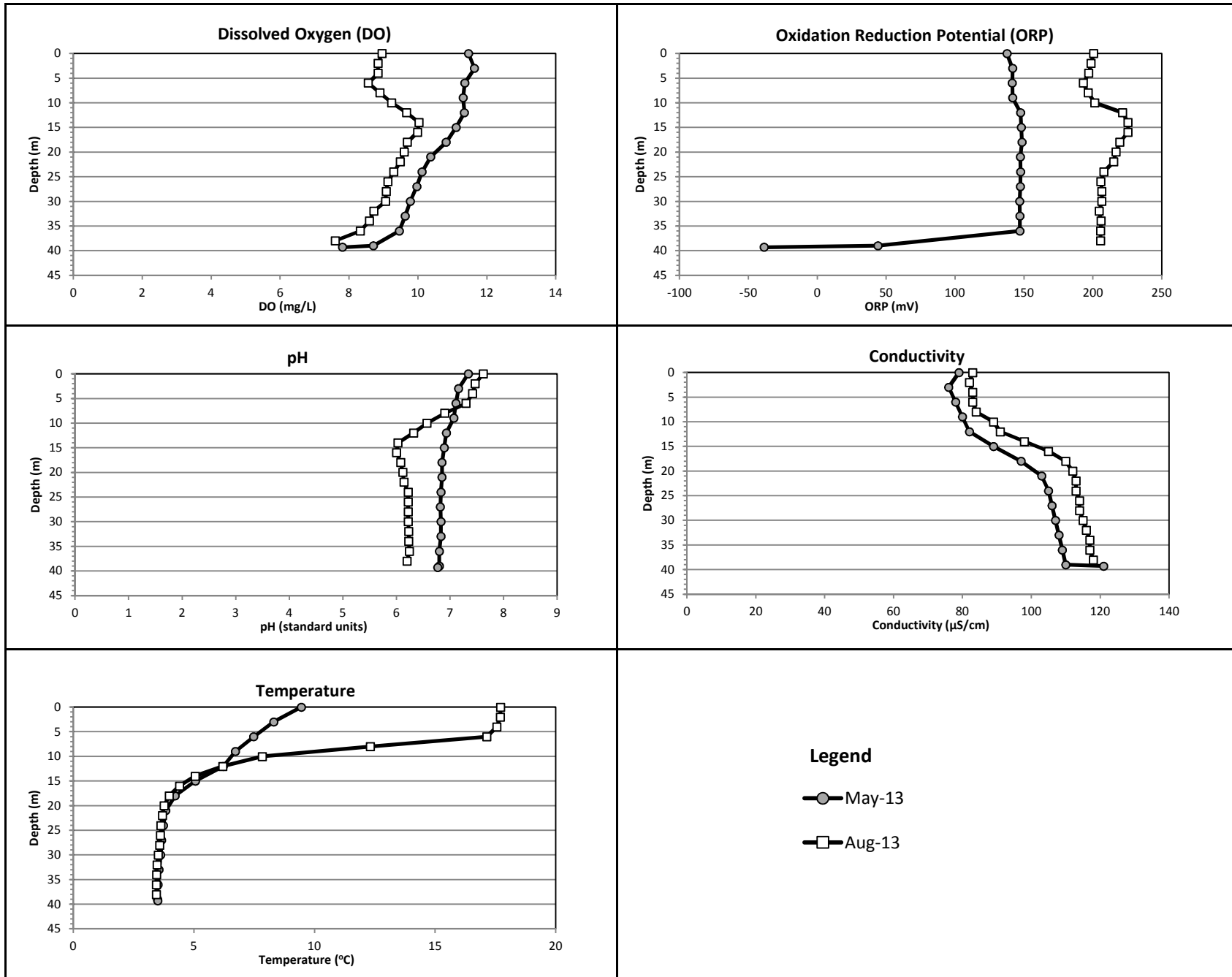

Water Column Profile Plots - Mesomikenda Lake (MESO-LS7)

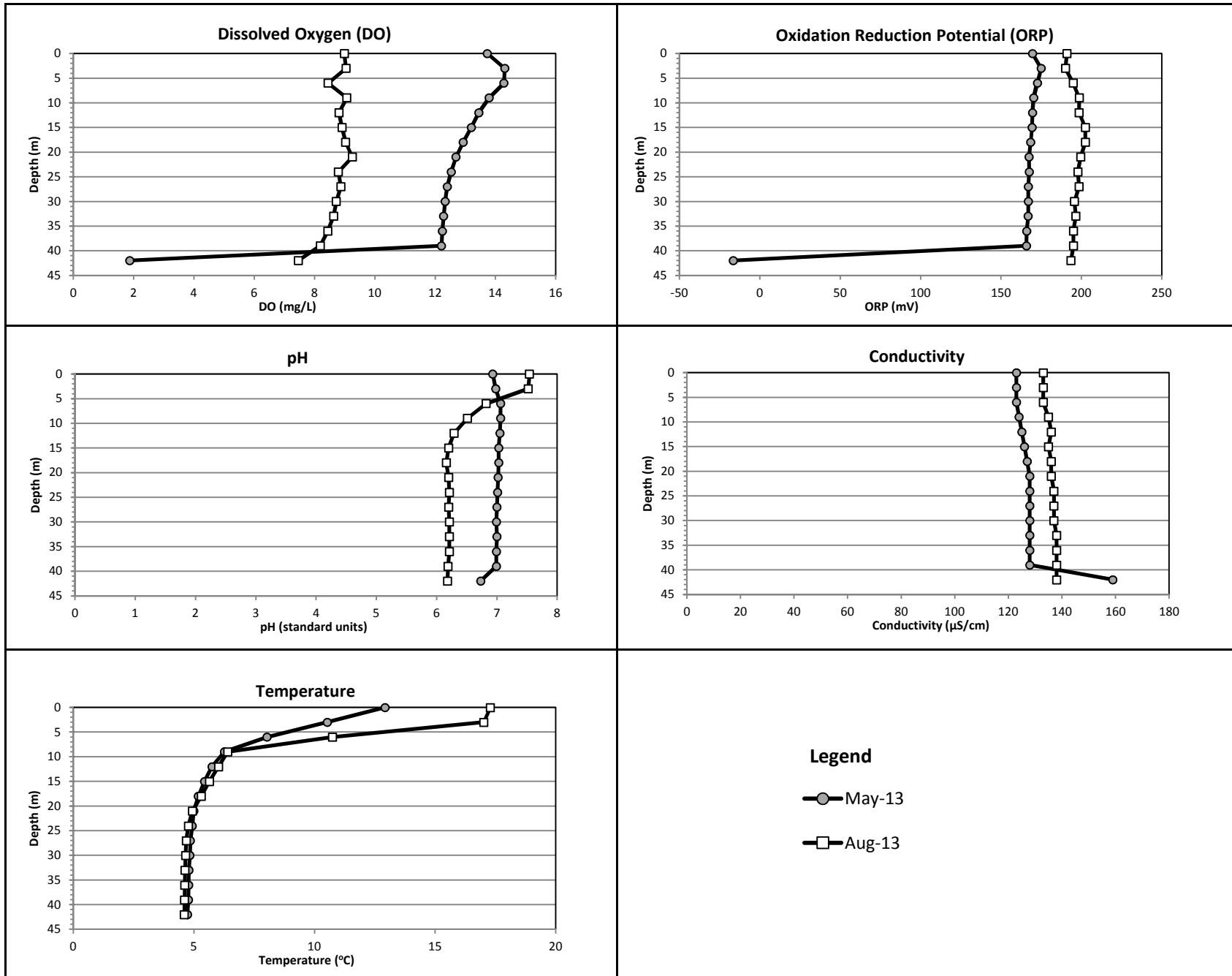

Water Column Profile Plots - Mesomikenda Lake (MESO-LS8)

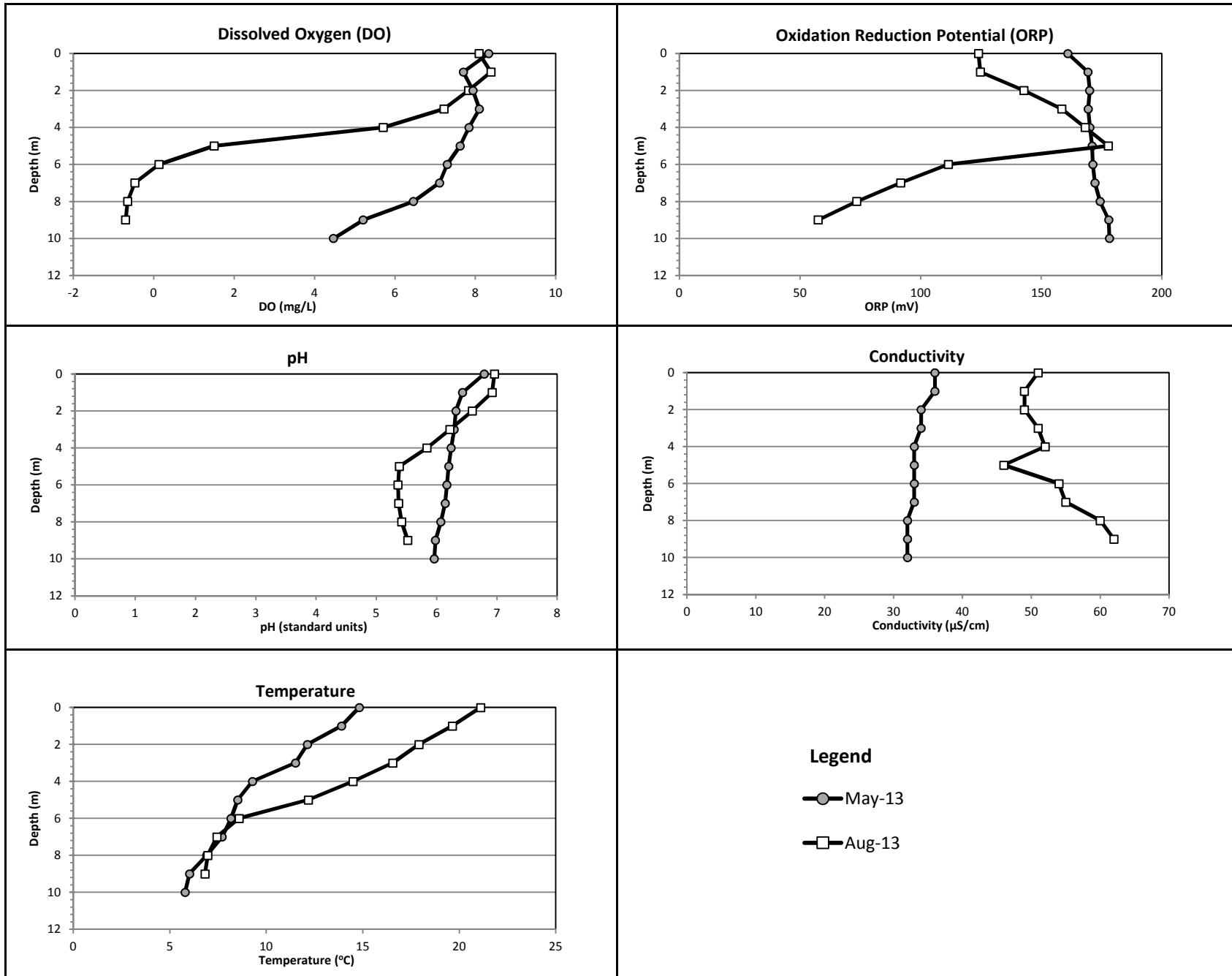

Water Column Profile Plots - Three Duck Lakes (3D-LS1)

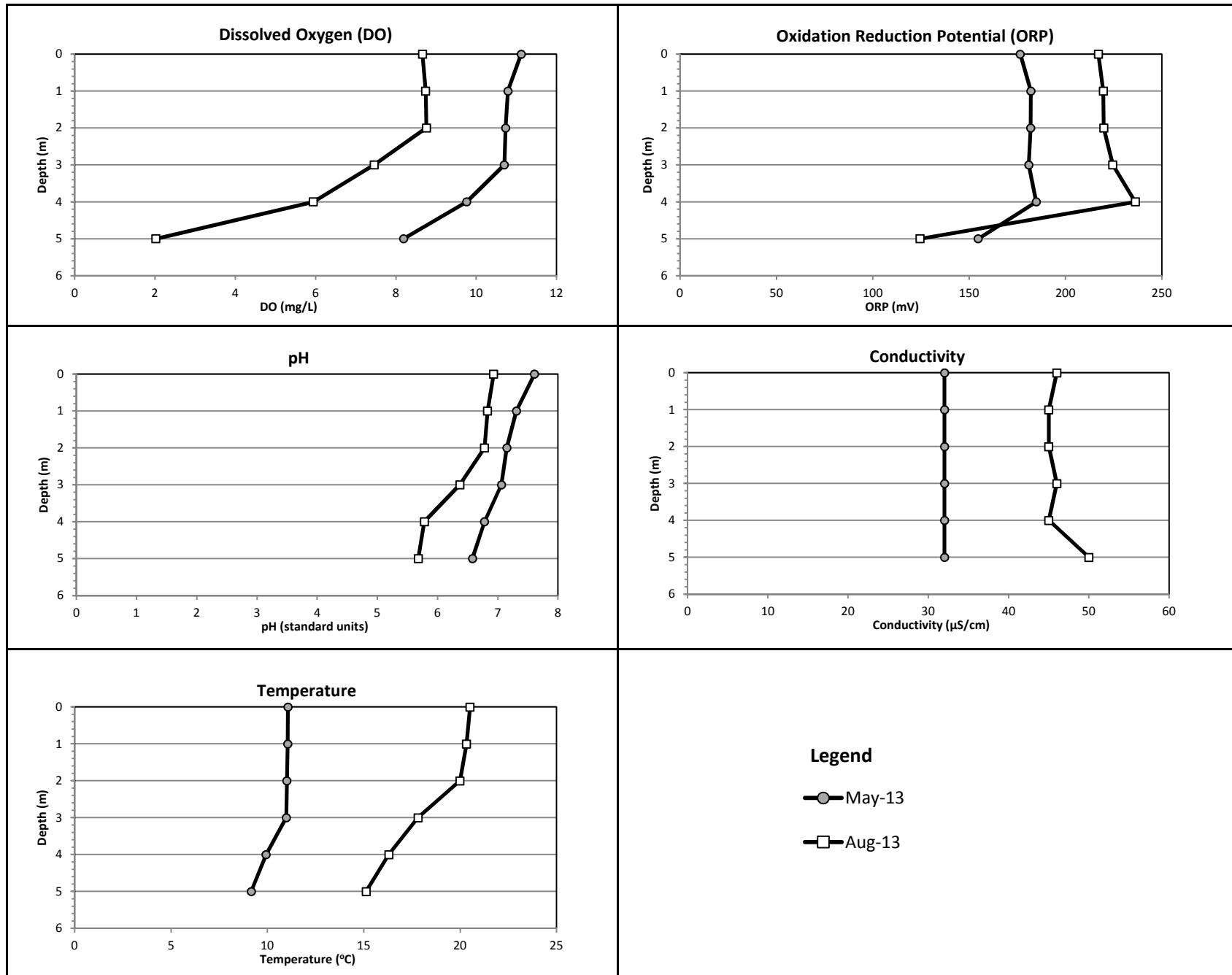

Water Column Profile Plots - Three Duck Lakes (3D-LS2)

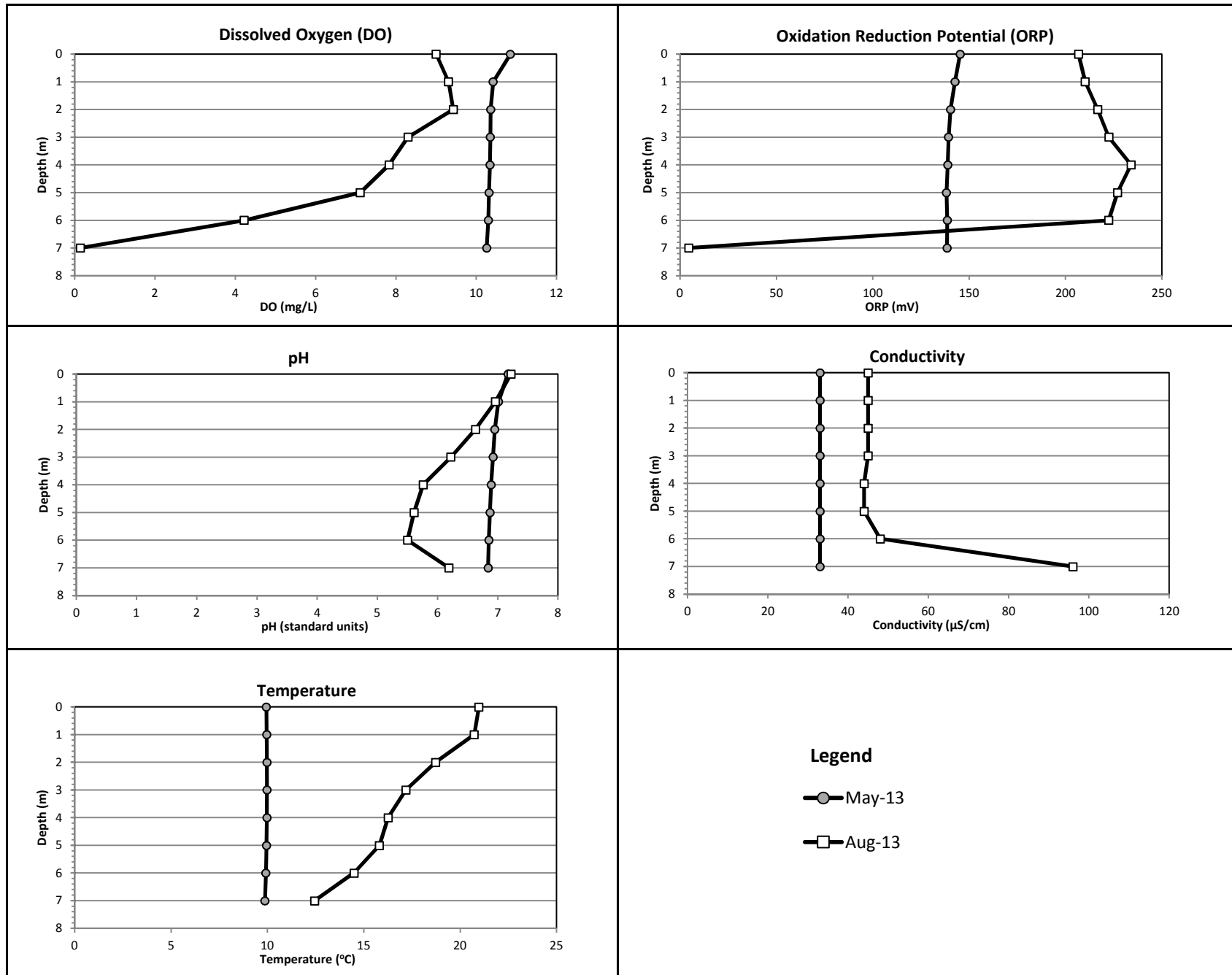



APPENDIX C

Groundwater Quality Results

APPENDIX C
2012 Groundwater Quality Results

Parameter ⁽¹⁾	Unit	Method Detection Limit	Ontario Drinking Water Standards ⁽¹⁾⁽²⁾		Canadian Water Quality Guidelines ⁽⁴⁾	Provincial Water Quality Objective ⁽⁵⁾	Open Pit Footprint											
			MAC	IMAC			BH12-1			BH12-2A			BH12-2B			BH12-3A		
							18-May-12	14-Aug-12	5-Dec-12	18-May-12	14-Aug-12	5-Dec-12	19-May-12	14-Aug-12	5-Dec-12	20-May-12	14-Aug-12	5-Dec-12
FIELD PARAMETERS																		
pH	pH units	--	--	--	6.5-9	6.5-8.5	6.33	6.71	7.66	6.02	6.49	8.6	6.41	5.96	8.86	7.53	6.32	7.87
Conductivity	µS/cm	--	--	--	--	--	396	263	272	142	192	187	105	94	187	218	238	231
Temperature	degrees Celsius	--	--	--	--	--	7.5	17.3	6.7	11.8	11.4	5.5	10.8	12.1	6.5	16.5	17	6.5
GENERAL PARAMETERS																		
pH	pH units	--	--	--	6.5-9	6.5-8.5	7.79	7.84	7.92	7.77	7.95	7.96	7.9	7.91	7.88	7.66	7.95	7.84
Alkalinity	µg/L as CaCO3	<5000	--	--	--	-25%	113000	135000	139000	92000	89000	92000	66000	48000	53000	115000	95000	108000
Acidity	µg/L as CaCO3	<5000	--	--	--	--	<5000	<5000	<5000	<5000	<5000	<5000	<5000	<5000	<5000	<5000	<5000	<5000
Electrical Conductivity (EC)	µS/cm	<2	--	--	--	--	240	276	283	205	191	198	121	102	90	246	224	246
Total Suspended Solids (TSS)	µg/L	<10000	--	--	+5000-25000 ⁽⁶⁾	--	820000	131000	110000	9120000	4640000	13000000	105000000	39400000	17600000	1240000	516000	208000
Total Dissolved Solids (TDS)	µg/L	<20000	--	--	--	--	128000	172000	160000	120000	128000	120000	320000	134000	58000	148000	144000	152000
Total Hardness	µg/L as CaCO3	<500	--	--	--	--	105000	144000	144000	94300	106000	90100	43600	69600	39500	119000	120000	123000
MAJOR IONS																		
Calcium (Ca)	µg/L	<50	--	--	--	--	35500	49900	51600	27700	30300	25900	14000	20600	12300	41700	41800	43000
Chloride (Cl)	µg/L	<100	--	--	--	--	1920	2850	2200	720	560	670	500	630	420	1690	1570	1220
Sodium (Na)	µg/L	<50	--	--	--	--	4140	3480	1840	6970	4910	3540	9920	2390	1310	5190	3170	2340
Fluoride (F)	µg/L	<50, <100, <50000	1500 ⁽⁷⁾	--	--	--	120	<50	<100	50	<50	<50	60	<50	<50	120	90	<50
Magnesium (Mg)	µg/L	<50	--	--	--	--	4070	4740	3790	6100	7470	6180	2100	4420	2140	3670	3810	3760
Potassium (K)	µg/L	<50	--	--	--	--	1870	2100	1010	1190	1540	950	628	1840	500	1560	1260	690
Sulphate (SO ₄)	µg/L	<100	--	--	--	--	7320	6810	7980	13700	13600	12200	5610	5840	5550	14100	20400	23300
METALS																		
Aluminum (Al)	µg/L	<4	--	--	100 ⁽⁸⁾	75 ⁽⁹⁾	34	43	20	7	8	11	14	64	22	13	15	10
Antimony (Sb)	µg/L	<6	--	6	--	20	<6	<6	<6	<6	<6	<6	<6	<6	<6	<6	<6	<6
Arsenic (As)	µg/L	<3	--	25	5	5	<3	<3	<3	<3	<3	<3	<3	<3	<3	<3	<3	<3
Barium (Ba)	µg/L	<2	1000	--	--	--	35	40	35	13	12	10	<2	3	2	17	18	16
Beryllium (Be)	µg/L	<1	--	--	--	11 ⁽¹⁰⁾	<1	<1	<1	<1	<1	<1	<1	<1	<1	<1	<1	<1
Boron (B)	µg/L	<10	--	5000	1500 ⁽¹¹⁾	200	23	<10	<10	<10	<10	<10	<10	<10	<10	<10	<10	<10
Cadmium (Cd)	µg/L	<0.1	--	5	0.058 ⁽¹²⁾	0.1 ⁽¹³⁾	<0.1	<0.1	<0.1	<0.1	<0.1	<0.1	<0.1	<0.1	<0.1	<0.1	<0.1	<0.1
Chromium (Cr)	µg/L	<3	50	--	8.9 ⁽¹⁴⁾	8.9 ⁽¹⁴⁾	<3	<3	<3	<3	<3	<3	<3	<3	<3	<3	<3	<3
Cobalt (Co)	µg/L	<0.5	--	--	--	0.9	<0.5	<0.5	<0.5	<0.5	<0.5	<0.5	<0.5	<0.5	<0.5	0.6	<0.5	<0.5
Copper (Cu)	µg/L	<2	--	--	2 ⁽¹⁵⁾	5 ⁽¹⁶⁾	3	<2	<2	<2	<2	<2	<2	<2	<2	4	2	<2
Iron (Fe)	µg/L	<10	--	--	300	300	<10	<10	<10	10	10	45	<10	<10	<10	122	<10	<10
Lead (Pb)	µg/L	<1	10 ⁽¹⁷⁾	--	1 ⁽¹⁸⁾	3 ⁽¹⁹⁾	<1	<1	<1	<1	<1	<1	<1	<1	<1	<1	<1	<1
Manganese (Mn)	µg/L	<2	--	--	--	--	123	107	<2	73	71	71	3	7	3	126	81	43
Mercury (Hg)	µg/L	<0.10	1	--	0.026	0.2	<0.1	<0.1	<0.1	<0.1	<0.1	<0.1	<0.1	<0.1	<0.1	<0.1	<0.1	<0.1
Molybdenum (Mo)	µg/L	<2	--	--	73	40	8	6	6	13	7	5	<2	<2	<2	41	73	89
Nickel (Ni)	µg/L	<3	--	--	25 ⁽²⁰⁾	25	<3	3	<3	<3	<3	<3	<3	<3	<3	<3	<3	<3
Selenium (Se)	µg/L	<4	10	--	1	100	<4	<4	<4	<4	<4	<4	<4	<4	<4	<4	<4	<4
Silver (Ag)	µg/L	<0.1	--	--	0.1	0.1	<0.1	0.1	<0.1	<0.1	<0.1	<0.1	<0.1	<0.1	<0.1	<0.1	<0.1	<0.1
Strontium (Sr)	µg/L	<5	--	--	--	--	82	72	59	47	40	39	27	31	23	46	40	40
Thallium (Tl)	µg/L	<0.3, <4	--	--	0.8	0.3	<0.3	<0.3	<0.3	<0.3	<0.3	<0.3	<0.3	<0.3	<0.3	<0.3	<0.3	<0.3
Titanium (Ti)	µg/L	<0.1, <2	--	--	--	--	<2	<2	<2	<2	<2	<2	<2	<2	<2	<2	<2	<2
Tungsten (W)	µg/L	<0.1, <10	--	--	--	30	32	13	<10	20	<10	<10	<10	<10	<10	78	55	22
Uranium (U)	µg/L	<2, <4	20	--	15	5	<2	2	2	<2	<2	<2	<2	<2	<2	<u>6</u>	<u>9</u>	<u>9</u>
Vanadium (V)	µg/L	<0.1, <2	--	--	--	6	<2	<2	<2	<2	<2	<2	<2	<2	<2	<2	<2	<2
Zinc (Zn)	µg/L	<4, <5	--	--	30	20	45	54	12	5	<5	<5	7	78	<5	6	<5	<5
Zirconium (Zr)	µg/L	<0.1, <4	--	--	--	4	<4	<4	<4	<4	<4	<4	<4	<4	<4	<4	<4	<4
NUTRIENTS																		
Nitrate (NO ₃ ⁻)	µg/L as N	<50	10000	--	13000 ⁽²¹⁾	--	170	--	720	<50	--	<50	90	--	<50	<50	<50	<50
Nitrite (NO ₂ ⁻)	µg/L as N	<50	1000	--	60 ⁽²²⁾	--	<50	--	<50	<50	--	<50	<50	--	<50	<50	--	<50
Total Ammonia (NH ₃ + NH ₄)	µg/L as N	<20	--	--	6980	--	<20	<20	<20	40	40	140	220	560	790	<20	<20	20
Un-ionized Ammonia	µg/L as N	<20	--	--	19 ⁽²³⁾	20 ⁽²³⁾	<20	<20	<20	<20	<20	<20	<20	<20	<u>30</u>	<20	<20	<20
NUTRIENTS																		
Free Cyanide	µg/L	<2	200	--	5	5	<2	2	<2	<2	3	<2	<2	<2	<2	<2	<2	<2
Sulphur (S)	µg/L	<50	--	--	--	--	--	--	--	--	--	--	--	--	--	--	--	--

APPENDIX C
2012 Groundwater Quality Results

Parameter ⁽¹⁾	Unit	Method Detection Limit	Ontario Drinking Water Standards ⁽¹⁾⁽²⁾		Canadian Water Quality Guidelines ⁽⁴⁾	Provincial Water Quality Objective ⁽⁵⁾	Open Pit Footprint														
			MAC	IMAC			BH12-3B			BH12-4			BH12-6			BH12-BULK1			DH12-PO-10		
							20-May-12	14-Aug-12	5-Dec-12	18-May-12	14-Aug-12	5-Dec-12	18-May-12	28-May-12	14-Aug-12	5-Dec-12	7-Jun-12	16-Aug-12	5-Dec-12		
FIELD PARAMETERS																					
pH	pH units	--	--	--	6.5-9	6.5-8.5	7.46	6.69	7.68	6.45	6.67	7.9	6.9	6.63	6.5	7.78	8.08	6.28	8.06		
Conductivity	µs/cm	--	--	--	--	--	107	99	127	162	133	130	134	268	279	287	273	335	282		
Temperature	degrees Celsius	--	--	--	--	--	13.6	11.6	7.4	9.1	12.7	6.5	8.1	10.2	17.4	7.3	1.8	12.7	5.8		
GENERAL PARAMETERS																					
pH	pH units	--	--	--	6.5-9	6.5-8.5	7.22	7.51	7.22	7.64	7.77	7.65	7.74	7.72	7.96	7.87	7.87	7.98	7.88		
Alkalinity	µg/L as CaCO3	<5000	--	--	--	-25%	46000	40000	61000	80000	53000	59000	83000	112000	114000	121000	147000	149000	142000		
Acidity	µg/L as CaCO3	<5000	--	--	--	--	<5000	<5000	<5000	<5000	<5000	<5000	<5000	<5000	<5000	<5000	<5000	<5000	<5000		
Electrical Conductivity (EC)	µS/cm	<2	--	--	--	--	115	103	140	164	124	137	173	265	275	299	279	344	289		
Total Suspended Solids (TSS)	µg/L	<10000	--	--	+5000-25000 ⁽⁶⁾	--	27800000	4330000	2430000	7050000	1760000	2830000	14400000	69000	130000	120000	1310000	924000	2000000		
Total Dissolved Solids (TDS)	µg/L	<20000	--	--	--	--	172000	66000	88000	116000	84000	90000	188000	152000	176000	178000	160000	234000	188000		
Total Hardness	µg/L as CaCO3	<500	--	--	--	--	52200	51600	65400	64500	71300	61700	48400	133000	142000	150000	137000	149000	144000		
MAJOR IONS																					
Calcium (Ca)	µg/L	<50	--	--	--	--	19400	18700	24400	21900	22300	20600	14500	48700	51700	55100	42100	46400	44500		
Chloride (Cl)	µg/L	<100	--	--	--	--	950	1150	1790	1930	640	1290	1670	1630	1430	1500	900	2710	1760		
Sodium (Na)	µg/L	<50	--	--	--	--	1740	2030	2160	10500	3380	1820	19600	3030	3160	2720	3320	19800	7700		
Fluoride (F)	µg/L	<50, <100, <50000	1500 ⁽⁷⁾	--	--	--	60	<50	<50	110	<50	<50	70	110	90	<50	140	110	110		
Magnesium (Mg)	µg/L	<50	--	--	--	--	910	1190	1080	2380	3790	2480	2950	2870	3140	3030	7720	8060	8010		
Potassium (K)	µg/L	<50	--	--	--	--	380	680	260	1060	1410	550	380	1330	1520	1160	1280	1710	1400		
Sulphate (SO ₄)	µg/L	<100	--	--	--	--	10600	8140	7040	7420	8770	8390	6610	25400	29200	34000	5080	32600	11200		
METALS																					
Aluminum (Al)	µg/L	<4	--	--	100 ⁽⁸⁾	75 ⁽⁹⁾	100	30	29	74	30	17	73	8	15	11	195	22	18		
Antimony (Sb)	µg/L	<6	--	6	--	20	<6	<6	<6	<6	<6	<6	<6	<6	<6	<6	<6	<6	<6		
Arsenic (As)	µg/L	<3	--	25	5	5	<3	<3	<3	<3	<3	<3	<3	<3	5	<3	<3	6	<3		
Barium (Ba)	µg/L	<2	1000	--	--	--	3	2	4	13	12	11	2	25	43	36	7	38	30		
Beryllium (Be)	µg/L	<1	--	--	--	11 ⁽¹⁰⁾	<1	<1	<1	<1	<1	<1	<1	<1	<1	<1	<1	<1	<1		
Boron (B)	µg/L	<10	--	5000	1500 ⁽¹¹⁾	200	<10	<10	11	11	<10	<10	13	10	12	<10	<10	15	13		
Cadmium (Cd)	µg/L	<0.1	--	5	0.058 ⁽¹²⁾	0.1 ⁽¹³⁾	<0.1	<0.1	<0.1	<0.1	<0.1	<0.1	<0.1	0.1	<0.1	0.1	<0.1	<0.1	<0.1		
Chromium (Cr)	µg/L	<3	50	--	8.9 ⁽¹⁴⁾	8.9 ⁽¹⁴⁾	<3	<3	<3	<3	<3	<3	<3	<3	<3	<3	<3	<3	<3		
Cobalt (Co)	µg/L	<0.5	--	--	--	0.9	<0.5	<0.5	<0.5	0.9	<0.5	<0.5	<0.5	<0.5	0.6	<0.5	<0.5	0.8	<0.5		
Copper (Cu)	µg/L	<2	--	--	2 ⁽¹⁵⁾	5 ⁽¹⁶⁾	4	4	5	16	3	<2	3	4	<2	3	8	3	7		
Iron (Fe)	µg/L	<10	--	--	300	300	57	28	<10	58	<10	<10	25	<10	105	<10	38	<10	135		
Lead (Pb)	µg/L	<1	10 ⁽¹⁷⁾	--	1 ⁽¹⁸⁾	3 ⁽¹⁹⁾	<1	<1	<1	<1	<1	<1	<1	<1	<1	<1	<1	<1	<1		
Manganese (Mn)	µg/L	<2	--	--	--	--	20	5	13	168	38	25	34	94	313	42	39	266	102		
Mercury (Hg)	µg/L	<0.10	1	--	0.026	0.2	<0.1	<0.1	<0.1	<0.1	<0.1	<0.1	<0.1	<0.1	<0.1	<0.1	<0.10	<0.1	<0.1		
Molybdenum (Mo)	µg/L	<2	--	--	73	40	5	5	5	3	<2	<2	<2	127	108	147	<2	48	30		
Nickel (Ni)	µg/L	<3	--	--	25 ⁽²⁰⁾	25	<3	<3	<3	<3	<3	<3	7	<3	3	<3	<3	9	5		
Selenium (Se)	µg/L	<4	10	--	1	100	<4	<4	<4	<4	<4	<4	<4	<4	<4	<4	<4	<4	<4		
Silver (Ag)	µg/L	<0.1	--	--	0.1	0.1	<0.1	<0.1	<0.1	<0.1	<0.1	<0.1	<0.1	<0.1	<0.1	<0.1	<0.1	<0.1	<0.1		
Strontium (Sr)	µg/L	<5	--	--	--	--	28	18	29	51	29	32	16	54	63	56	42	88	82		
Thallium (Tl)	µg/L	<0.3, <4	--	--	0.8	0.3	<0.3	<0.3	<0.3	<0.3	<0.3	<0.3	<0.3	<0.3	<0.3	<0.3	<0.3	<0.3	<0.3		
Titanium (Ti)	µg/L	<0.1, <2	--	--	--	--	2	2	2	2	<2	<2	2	<2	<2	<2	<2	<2	<2		
Tungsten (W)	µg/L	<0.1, <10	--	--	--	30	<10	<10	<10	212	55	23	232	14	<10	<10	21	91	54		
Uranium (U)	µg/L	<2, <4	20	--	15	5	<2	<2	<2	<2	<2	8	<2	13	7	14	<2	2	<2		
Vanadium (V)	µg/L	<0.1, <2	--	--	--	6	<2	<2	<2	<2	<2	<2	<2	<2	<2	<2	<2	<2	<2		
Zinc (Zn)	µg/L	<4, <5	--	--	30	20	145	<5	41	20	22	10	9	9	8	<5	385	385	61		
Zirconium (Zr)	µg/L	<0.1, <4	--	--	--	4	<4	<4	<4	<4	<4	<4	<4	<4	<4	<4	<4	<4	<4		
NUTRIENTS																					
Nitrate (NO ₃ ⁻)	µg/L as N	<50	10000	--	13000 ⁽²¹⁾	--	<50	<50	<50	<50	<50	120	140	130	<50	<50	120	--	170		
Nitrite (NO ₂ ⁻)	µg/L as N	<50	1000	--	60 ⁽²²⁾	--	<50	--	<50	<50	--	<50	<50	<50	--	<50	<50	--	<50		
Total Ammonia (NH ₃ + NH ₄)	µg/L as N	<20	--	--	6980	--	<20	30	<20	40	<20	<20	150	<20	40	<20	<20	<20	40		
Un-ionized Ammonia	µg/L as N	<20	--	--	19 ⁽²³⁾	20 ⁽²³⁾	<20	<20	<20	<20	<20	<20	<20	<20	<20	<20	<20	<20	<20		
NUTRIENTS																					
Free Cyanide	µg/L	<2	200	--	5	5	<2	<2	<2	<2	<2	<2	<2	5	<2	<2	<2	<2	<2		
Sulphur (S)	µg/L	<50	--	--	--	--	--	--	--	--	--	--	--	--	--	--	1860	--	--		

APPENDIX C
2012 Groundwater Quality Results

Parameter ⁽¹⁾	Unit	Method Detection Limit	Ontario Drinking Water Standards ⁽¹⁾⁽²⁾		Canadian Water Quality Guidelines ⁽⁴⁾	Provincial Water Quality Objective ⁽⁵⁾	Open Pit Footprint			Tailings Management Facility Footprint and Adjacent Areas									
			MAC	IMAC			DH12-PO-14B			DH12-TMF-05A			DH12-TMF-05B			DH12-TMF-12			
							28-May-12	15-Aug-12	5-Dec-12	6-Jun-12	14-Aug-01	29-Nov-12	6-Jun-12	14-Aug-12	29-Nov-12	13-Jun-12	14-Aug-12	29-Nov-12	
FIELD PARAMETERS																			
pH	pH units	--	--	--	6.5-9	6.5-8.5	7.93	6.94	8.33	7.76	6.54	7.91	7.09	6.54	6.96	6.18	7.6	7.51	
Conductivity	µS/cm	--	--	--	--	--	192	203	213	592	415	382	552	783	761	670	787	727	
Temperature	degrees Celsius	--	--	--	--	--	8.2	10.8	4.5	9.2	11.1	--	14.9	15.5	--	9.8	9.6	--	
GENERAL PARAMETERS																			
pH	pH units	--	--	--	6.5-9	6.5-8.5	7.83	8.04	7.99	7.81	8.01	7.89	7.89	7.97	7.91	7.75	7.94	7.81	
Alkalinity	µg/L as CaCO ₃	<5000	--	--	--	-25%	91000	95000	106000	125000	136000	136000	232000	342000	328000	88000	87000	87000	
Acidity	µg/L as CaCO ₃	<5000	--	--	--	--	<5000	<5000	<5000	<5000	<5000	<5000	<5000	<5000	<5000	<5000	<5000	<5000	
Electrical Conductivity (EC)	µS/cm	<2	--	--	--	--	189	208	225	589	385	429	486	706	764	766	748	741	
Total Suspended Solids (TSS)	µg/L	<10000	--	--	+5000-25000 ⁽⁶⁾	--	16000000	5560000	5970000	2640000	4910000	5240000	5680000	3440000	25800000	3260000	2350000	8050000	
Total Dissolved Solids (TDS)	µg/L	<20000	--	--	--	--	184000	134000	144000	378000	272000	398000	360000	554000	564000	574000	558000	468000	
Total Hardness	µg/L as CaCO ₃	<500	--	--	--	--	81300	113000	105000	129000	141000	143000	200000	187000	231000	340000	343000	322000	
MAJOR IONS																			
Calcium (Ca)	µg/L	<50	--	--	--	--	24800	33200	31700	39000	40200	40900	53400	52100	61900	84600	86100	82300	
Chloride (Cl)	µg/L	<100	--	--	--	--	2440	3480	4160	15100	6670	9090	7850	13500	13300	16300	17100	17500	
Sodium (Na)	µg/L	<50	--	--	--	--	8550	7160	4070	77400	29100	39800	36300	108000	96100	36300	36500	39100	
Fluoride (F)	µg/L	<50, <100, <50000	1500 ⁽⁷⁾	--	--	--	140	90	<50	280	760	640	<50	<50	<50	<50	<50	<50	
Magnesium (Mg)	µg/L	<50	--	--	--	--	4710	7310	6330	7590	9890	9940	16300	13800	18600	31200	31200	28300	
Potassium (K)	µg/L	<50	--	--	--	--	590	1310	920	4760	3820	2810	2640	3470	3050	2190	2340	2080	
Sulphate (SO ₄)	µg/L	<100	--	--	--	--	8270	9840	9560	152000	53500	75900	26500	32900	78700	300000	310000	278000	
METALS																			
Aluminum (Al)	µg/L	<4	--	--	100 ⁽⁸⁾	75 ⁽⁹⁾	<u>94</u>	15	25	146	116	42	123	134	142	9	5	12	
Antimony (Sb)	µg/L	<6	--	6	--	20	<6	<6	<6	<6	<6	<6	<6	<6	<6	<6	<6	<6	
Arsenic (As)	µg/L	<3	--	25	5	5	<3	3	<3	<3	<3	<3	<3	<3	<3	<3	<3	<3	
Barium (Ba)	µg/L	<2	1000	--	--	--	15	13	18	59	42	36	39	63	45	22	30	25	
Beryllium (Be)	µg/L	<1	--	--	--	11 ⁽¹⁰⁾	<1	<1	<1	<1	<1	<1	<1	<1	<1	<1	<1	<1	
Boron (B)	µg/L	<10	--	5000	1500 ⁽¹¹⁾	200	<10	<10	<10	31	34	32	<10	20	12	40	47	48	
Cadmium (Cd)	µg/L	<0.1	--	5	0.058 ⁽¹²⁾	0.1 ⁽¹³⁾	<0.1	<0.1	<0.1	<0.1	<0.1	<0.1	<0.1	<0.1	<0.1	<0.1	<0.1	<0.1	
Chromium (Cr)	µg/L	<3	50	--	8.9 ⁽¹⁴⁾	8.9 ⁽¹⁴⁾	<3	<3	<3	<3	<3	<3	4	8	9	<3	<3	<3	
Cobalt (Co)	µg/L	<0.5	--	--	--	0.9	<0.5	<0.5	<0.5	0.6	<0.5	<0.5	3.9	2.7	2.9	<0.5	<0.5	<0.5	
Copper (Cu)	µg/L	<2	--	--	2 ⁽¹⁵⁾	5 ⁽¹⁶⁾	<2	<2	<2	2	2	<2	<2	<2	<2	<2	<2	<2	
Iron (Fe)	µg/L	<10	--	--	300	300	32	73	89	184	<10	23	7230	12200	13800	28	164	223	
Lead (Pb)	µg/L	<1	10 ⁽¹⁷⁾	--	1 ⁽¹⁸⁾	3 ⁽¹⁹⁾	<1	<1	<1	<1	<1	<1	<1	<1	<1	<1	<1	<1	
Manganese (Mn)	µg/L	<2	--	--	--	--	56	64	62	320	201	151	553	609	731	832	832	864	
Mercury (Hg)	µg/L	<0.10	1	--	0.026	0.2	<0.1	<0.1	<0.1	<0.10	<0.1	<0.1	<0.10	<0.1	<0.1	<0.1	<0.1	<0.1	
Molybdenum (Mo)	µg/L	<2	--	--	73	40	10	5	6	179	49	16	3	5	2	4	4	5	
Nickel (Ni)	µg/L	<3	--	--	25 ⁽²⁰⁾	25	<3	<3	<3	5	6	<3	5	5	<3	<3	3	<3	
Selenium (Se)	µg/L	<4	10	--	1	100	<4	<4	<4	<4	<4	<4	<4	<4	<4	<4	<4	<4	
Silver (Ag)	µg/L	<0.1	--	--	0.1	0.1	<0.1	<0.1	<0.1	<0.1	<0.1	<0.1	<0.1	<0.1	<0.1	<0.1	<0.1	<0.1	
Strontium (Sr)	µg/L	<5	--	--	--	--	69	65	79	292	314	319	167	224	183	523	590	578	
Thallium (Tl)	µg/L	<0.3, <4	--	--	0.8	0.3	<0.3	<0.3	<0.3	<0.3	<0.3	<0.3	<0.3	<0.3	<0.3	<0.3	<0.3	<0.3	
Titanium (Ti)	µg/L	<0.1, <2	--	--	--	--	<2	<2	<2	5	2	<2	8	14	12	5	6	5	
Tungsten (W)	µg/L	<0.1, <10	--	--	--	30	92	28	43	15	10	<10	<10	<10	<10	<10	<10	<10	
Uranium (U)	µg/L	<2, <4	20	--	15	5	<2	<2	<2	5	<u>7</u>	5	<2	<2	<2	3	3	4	
Vanadium (V)	µg/L	<0.1, <2	--	--	--	6	<2	<2	<2	<2	<2	<2	6	6	6	<2	<2	<2	
Zinc (Zn)	µg/L	<4, <5	--	--	30	20	153	<5	23	96	35	59	1250	11	<5	16	<5	8	
Zirconium (Zr)	µg/L	<0.1, <4	--	--	--	4	<4	<4	<4	<4	<4	<4	<4	<4	<4	<4	<4	<4	
NUTRIENTS																			
Nitrate (NO ₃ ⁻)	µg/L as N	<50	10000	--	13000 ⁽²¹⁾	--	<50	--	<50	<50	--	120	<50	--	<50	<50	--	<50	
Nitrite (NO ₂ ⁻)	µg/L as N	<50	1000	--	60 ⁽²²⁾	--	<50	--	<50	<50	--	<50	<50	--	<50	<50	--	<50	
Total Ammonia (NH ₃ + NH ₄)	µg/L as N	<20	--	--	6980	--	270	100	130	<20	<20	70	200	350	270	<20	20	<20	
Un-Ionized Ammonia	µg/L as N	<20	--	--	19 ⁽²³⁾	20 ⁽²³⁾	<20	<20	<20	<20	<20	--	<20	<20	--	<20	<20	--	
NUTRIENTS																			
Free Cyanide	µg/L	<2	200	--	5	5	<2	<2	<2	<2	<2	<2	4	<2	<2	<2	<2	<2	
Sulphur (S)	µg/L	<50	--	--	--	--	--	--	--	50400	--	--	9100	--	--	--	--	--	

APPENDIX C
2012 Groundwater Quality Results

Parameter ⁽¹⁾	Unit	Method Detection Limit	Ontario Drinking Water Standards ⁽¹⁾⁽²⁾		Canadian Water Quality Guidelines ⁽⁴⁾	Provincial Water Quality Objective ⁽⁵⁾	Tailings Management Facility Footprint and Adjacent Areas														
			MAC	IMAC			DH12-TMF-16			DH12-TMF-27A			DH12-TMF-27B			DH12-TMF-28			DH12-TMF-31A		
							6-Jun-12	29-May-12	15-Aug-12	29-Nov-12	29-May-12	15-Aug-12	29-Nov-12	13-Jun-12	16-Aug-12	29-Nov-12	5-Jun-12	16-Aug-12	29-Nov-12		
FIELD PARAMETERS																					
pH	pH units	--	--	--	6.5-9	6.5-8.5	8.16	7.74	7.49	7	7.97	7.1	7.07	6.31	7.53	7.55	7.93	7.37	7.74		
Conductivity	µs/cm	--	--	--	--	--	126	57	94	80	62	88	99	318	469	350	229	226	226		
Temperature	degrees Celsius	--	--	--	--	--	10	6.9	9.7	--	8.7	10.3	--	8.4	13.4	5	6.7	8.6	4.6		
GENERAL PARAMETERS																					
pH	pH units	--	--	--	6.5-9	6.5-8.5	7.58	7.29	7.72	7.43	7.16	7.5	7.49	7.8	7.93	7.82	7.86	8.03	7.98		
Alkalinity	µg/L as CaCO ₃	<5000	--	--	--	-25%	64000	41000	55000	43000	33000	40000	41000	99000	94000	99000	123000	116000	117000		
Acidity	µg/L as CaCO ₃	<5000	--	--	--	--	<5000	<5000	<5000	<5000	<5000	<5000	<5000	<5000	<5000	<5000	<5000	<5000	<5000		
Electrical Conductivity (EC)	µS/cm	<2	--	--	--	--	136	149	138	101	91	94	93	346	401	358	241	233	240		
Total Suspended Solids (TSS)	µg/L	<10000	--	--	+5000-25000 ⁽⁶⁾	--	1250000	2900000	3810000	598000	7420000	11000000	2330000	548000	304000	138000	578000	648000	797000		
Total Dissolved Solids (TDS)	µg/L	<20000	--	--	--	--	86000	66000	80000	74000	70000	102000	66000	220000	308000	222000	134000	146000	282000		
Total Hardness	µg/L as CaCO ₃	<500	--	--	--	--	62800	40300	58400	46200	32200	43300	40800	145000	169000	153000	121000	124000	127000		
MAJOR IONS																					
Calcium (Ca)	µg/L	<50	--	--	--	--	17400	9750	14300	11000	6120	7850	7850	39300	45300	41200	43000	43800	45500		
Chloride (Cl)	µg/L	<100	--	--	--	--	420	350	480	600	440	440	350	5370	7110	5410	510	500	550		
Sodium (Na)	µg/L	<50	--	--	--	--	2040	1640	3190	2250	2090	2700	2260	19100	23300	16000	1390	1410	1410		
Fluoride (F)	µg/L	<50, <100, <50000	1500 ⁽⁷⁾	--	--	--	70	90	120	70	80	<50	<50	580	970	830	<50	<50	<50		
Magnesium (Mg)	µg/L	<50	--	--	--	--	4690	3870	5520	4540	4100	5750	5150	11500	13500	12100	3430	3660	3210		
Potassium (K)	µg/L	<50	--	--	--	--	430	410	730	470	450	600	400	1210	1670	1120	470	640	300		
Sulphate (SO ₄)	µg/L	<100	--	--	--	--	5910	4460	5750	6840	4630	5150	5230	70100	102000	75800	8320	8650	8880		
METALS																					
Aluminum (Al)	µg/L	<4	--	--	100 ⁽⁸⁾	75 ⁽⁹⁾	184	14	10	52	39	20	25	17	45	9	27	38	13		
Antimony (Sb)	µg/L	<6	--	6	--	20	<6	<6	<6	<6	<6	<6	<6	<6	<6	<6	<6	<6	<6		
Arsenic (As)	µg/L	<3	--	25	5	5	<3	<3	<3	<3	<3	<3	<3	<3	<3	<3	<3	<3	<3		
Barium (Ba)	µg/L	<2	1000	--	--	--	6	<2	5	6	2	2	2	29	57	37	7	5	5		
Beryllium (Be)	µg/L	<1	--	--	--	11 ⁽¹⁰⁾	<1	<1	<1	<1	<1	<1	<1	<1	<1	<1	<1	<1	<1		
Boron (B)	µg/L	<10	--	5000	1500 ⁽¹¹⁾	200	<10	<10	<10	<10	<10	<10	<10	18	19	12	<10	<10	<10		
Cadmium (Cd)	µg/L	<0.1	--	5	0.058 ⁽¹²⁾	0.1 ⁽¹³⁾	<0.1	<0.1	<0.1	<0.1	0.1	<0.1	<0.1	<0.1	<0.1	<0.1	<0.1	<0.1	<0.1		
Chromium (Cr)	µg/L	<3	50	--	8.9 ⁽¹⁴⁾	8.9 ⁽¹⁴⁾	<3	<3	<3	<3	<3	<3	<3	<3	<3	<3	<3	<3	<3		
Cobalt (Co)	µg/L	<0.5	--	--	--	0.9	<0.5	<0.5	<0.5	<0.5	<0.5	<0.5	<0.5	<0.5	<0.5	<0.5	<0.5	<0.5	<0.5		
Copper (Cu)	µg/L	<2	--	--	2 ⁽¹⁵⁾	5 ⁽¹⁶⁾	6	<2	2	3	<2	<2	<2	<2	<2	<2	<2	<2	<2		
Iron (Fe)	µg/L	<10	--	--	300	300	20	<10	<10	15	<10	<10	<10	297	168	256	<10	<10	<10		
Lead (Pb)	µg/L	<1	10 ⁽¹⁷⁾	--	1 ⁽¹⁸⁾	3 ⁽¹⁹⁾	<1	<1	<1	<1	<1	<1	<1	<1	<1	<1	<1	<1	<1		
Manganese (Mn)	µg/L	<2	--	--	--	--	17	12	27	31	7	2	<2	284	462	433	8	6	4		
Mercury (Hg)	µg/L	<0.10	1	--	0.026	0.2	<0.10	<0.10	<0.1	<0.1	<0.10	<0.1	<0.1	<0.1	<0.1	<0.1	<0.10	<0.1	<0.1		
Molybdenum (Mo)	µg/L	<2	--	--	73	40	<2	<2	<2	<2	<2	<2	<2	9	6	3	<2	<2	<2		
Nickel (Ni)	µg/L	<3	--	--	25 ⁽²⁰⁾	25	<3	<3	<3	<3	<3	<3	<3	<3	<3	<3	<3	<3	<3		
Selenium (Se)	µg/L	<4	10	--	1	100	<4	<4	<4	<4	<4	<4	<4	<4	<4	<4	<4	<4	<4		
Silver (Ag)	µg/L	<0.1	--	--	0.1	0.1	0.2	0.2	<0.1	0.2	<0.1	<0.1	<0.1	<0.1	<0.1	<0.1	0.2	<0.1	<0.1		
Strontium (Sr)	µg/L	<5	--	--	--	--	34	14	25	27	16	19	22	81	112	85	29	38	33		
Thallium (Tl)	µg/L	<0.3, <4	--	--	0.8	0.3	<0.3	<0.3	<0.3	<0.3	<0.3	<0.3	<0.3	<0.3	<0.3	<0.3	<0.3	<0.3	<0.3		
Titanium (Ti)	µg/L	<0.1, <2	--	--	--	--	<2	<2	<2	3	<2	<2	<2	3	<2	<2	<2	<2	<2		
Tungsten (W)	µg/L	<0.1, <10	--	--	--	30	74	38	42	13	<10	<10	<10	27	20	<10	22	12	<10		
Uranium (U)	µg/L	<2, <4	20	--	15	5	<2	<2	<2	<2	<2	<2	<2	3	5	5	<2	<2	<2		
Vanadium (V)	µg/L	<0.1, <2	--	--	--	6	2	<2	<2	<2	<2	<2	<2	<2	<2	<2	<2	<2	<2		
Zinc (Zn)	µg/L	<4, <5	--	--	30	20	353	<5	<5	<5	22	<5	8	5	69	<5	10	53	20		
Zirconium (Zr)	µg/L	<0.1, <4	--	--	--	4	<4	<4	<4	<4	<4	<4	<4	<4	<4	<4	<4	<4	<4		
NUTRIENTS																					
Nitrate (NO ₃ ⁻)	µg/L as N	<50	10000	--	13000 ⁽²¹⁾	--	410	<50	--	<50	<50	--	70	<50	--	<50	<50	--	210		
Nitrite (NO ₂ ⁻)	µg/L as N	<50	1000	--	60 ⁽²²⁾	--	<50	<50	--	<50	<50	--	<50	<50	--	<50	<50	--	<50		
Total Ammonia (NH ₃ + NH ₄)	µg/L as N	<20	--	--	6980	--	<20	<20	60	30	<20	60	30	<20	<20	<20	<20	<20	40		
Un-ionized Ammonia	µg/L as N	<20	--	--	19 ⁽²³⁾	20 ⁽²³⁾	<20	<20	<20	--	<20	<20	--	<20	<20	<20	<20	<20	<20		
NUTRIENTS																					
Free Cyanide	µg/L	<2	200	--	5	5	<2	<2	<2	<2	<2	<2	<2	<2	<2	<2	5	<2	<2		
Sulphur (S)	µg/L	<50	--	--	--	--	2040	1520	--	--	1580	--	--	--	--	--	2830	--	--		

APPENDIX C
2012 Groundwater Quality Results

Parameter ⁽¹⁾	Unit	Method Detection Limit	Ontario Drinking Water Standards ⁽¹⁾⁽²⁾		Canadian Water Quality Guidelines ⁽⁴⁾	Provincial Water Quality Objective ⁽⁵⁾	Tailings Management Facility Footprint and Adjacent Areas									North of Tailings Management Facility				
			MAC	IMAC			DH12-TMF-31B			DH12-TMF-32A		DH12-TMF-32B			DH12-TMF-23A		DH12-TMF-23B			
							5-Jun-12	16-Aug-12	29-Nov-12	15-Aug-12	29-Nov-12	28-May-12	15-Aug-12	29-Nov-12	5-Jun-12	15-Aug-12	5-Jun-12	15-Aug-12	29-Nov-12	
FIELD PARAMETERS																				
pH	pH units	--	--	--	6.5-9	6.5-8.5	8.02	--	7.44	7.53	8.01	8.5	6.9	7.06	7.99	6.97	8.3	6.75	7.14	
Conductivity	µS/cm	--	--	--	--	--	133	--	95	302	303	122	120	132	157	172	107	99	88	
Temperature	degrees Celsius	--	--	--	--	--	6.7	--	4.6	13.8	5	8.06	13.5	5.7	8.3	10.6	6.4	10	6.5	
GENERAL PARAMETERS																				
pH	pH units	--	--	--	6.5-9	6.5-8.5	7.65	7.83	7.58	7.95	8.05	7.22	7.58	7.47	7.78	7.85	7.58	7.78	7.54	
Alkalinity	µg/L as CaCO ₃	<5000	--	--	--	-25%	74000	83000	46000	132000	136000	55000	52000	65000	102000	73000	58000	53000	52000	
Acidity	µg/L as CaCO ₃	<5000	--	--	--	--	<5000	<5000	<5000	<5000	<5000	<5000	<5000	<5000	<5000	<5000	<5000	<5000	<5000	
Electrical Conductivity (EC)	µS/cm	<2	--	--	--	--	160	183	115	295	304	126	126	146	260	175	121	117	113	
Total Suspended Solids (TSS)	µg/L	<10000	--	--	+5000-25000 ⁽⁶⁾	--	22800000	12900000	2830000	1140000	953000	1380000	4500000	785000	286000	418000	6820000	1140000	1550000	
Total Dissolved Solids (TDS)	µg/L	<20000	--	--	--	--	116000	138000	214000	208000	168000	74000	92000	86000	110000	124000	114000	88000	68000	
Total Hardness	µg/L as CaCO ₃	<500	--	--	--	--	76400	95000	51500	129000	142000	55500	60500	70900	76600	76400	50000	58400	52700	
MAJOR IONS																				
Calcium (Ca)	µg/L	<50	--	--	--	--	29000	35000	19100	41500	46100	20600	22300	26300	22600	22300	16000	18800	17100	
Chloride (Cl)	µg/L	<100	--	--	--	--	520	530	1170	1270	1190	530	540	530	3590	2730	390	470	460	
Sodium (Na)	µg/L	<50	--	--	--	--	1150	1560	1270	13700	11600	1330	1570	1310	5370	7700	4830	2700	2220	
Fluoride (F)	µg/L	<50, <100, <50000	1500 ⁽⁷⁾	--	--	--	<50	<50	<50	392	380	<50	<50	<50	160	160	120	<50	<50	
Magnesium (Mg)	µg/L	<50	--	--	--	--	980	1840	920	6140	6440	990	1170	1260	4890	5040	2450	2780	2440	
Potassium (K)	µg/L	<50	--	--	--	--	340	1580	80	1770	1610	430	460	240	1340	1280	300	660	170	
Sulphate (SO ₄)	µg/L	<100	--	--	--	--	7540	8990	8070	22100	24200	5930	6690	7470	7450	11800	4220	5200	3580	
METALS																				
Aluminum (Al)	µg/L	<4	--	--	100 ⁽⁸⁾	75 ⁽⁹⁾	38	43	68	35	37	180	31	6	21	29	68	25	12	
Antimony (Sb)	µg/L	<6	--	6	--	20	<6	<6	<6	<6	6	<6	<6	<6	<6	<6	<6	<6	<6	
Arsenic (As)	µg/L	<3	--	25	5	5	<3	<3	<3	16	179	<3	<3	<3	<3	<3	<3	<3	<3	
Barium (Ba)	µg/L	<2	1000	--	--	--	5	3	2	20	34	5	3	3	8	27	5	4	3	
Beryllium (Be)	µg/L	<1	--	--	--	11 ⁽¹⁰⁾	<1	<1	<1	<1	<1	<1	<1	<1	<1	<1	<1	<1	<1	
Boron (B)	µg/L	<10	--	5000	1500 ⁽¹¹⁾	200	<10	<10	<10	119	149	<10	<10	<10	12	14	<10	<10	<10	
Cadmium (Cd)	µg/L	<0.1	--	5	0.058 ⁽¹²⁾	0.1 ⁽¹³⁾	<0.1	<0.1	<0.1	<0.1	0.1	0.2	<0.1	<0.1	<0.1	<0.1	<0.1	<0.1	<0.1	
Chromium (Cr)	µg/L	<3	50	--	8.9 ⁽¹⁴⁾	8.9 ⁽¹⁴⁾	<3	<3	<3	<3	<3	<3	<3	<3	<3	<3	<3	<3	<3	
Cobalt (Co)	µg/L	<0.5	--	--	--	0.9	<0.5	<0.5	<0.5	<0.5	0.5	<0.5	<0.5	<0.5	<0.5	<0.5	<0.5	<0.5	<0.5	
Copper (Cu)	µg/L	<2	--	--	2 ⁽¹⁵⁾	5 ⁽¹⁶⁾	<2	<2	<2	<2	<2	15	<2	<2	<2	<2	<2	<2	<2	
Iron (Fe)	µg/L	<10	--	--	300	300	<10	40	51	<10	<10	18	<10	<10	<10	140	13	<10	<10	
Lead (Pb)	µg/L	<1	10 ⁽¹⁷⁾	--	1 ⁽¹⁸⁾	3 ⁽¹⁹⁾	<1	<1	<1	<1	<1	<1	<1	<1	<1	<1	<1	<1	<1	
Manganese (Mn)	µg/L	<2	--	--	--	--	39	66	14	130	15	116	76	8	92	155	25	15	5	
Mercury (Hg)	µg/L	<0.10	1	--	0.026	0.2	<0.10	<0.1	<0.1	<0.1	<0.1	<0.10	<0.1	<0.1	<0.10	<0.1	<0.10	<0.1	<0.1	
Molybdenum (Mo)	µg/L	<2	--	--	73	40	<2	<2	<2	12	15	<2	<2	<2	<2	2	<2	<2	<2	
Nickel (Ni)	µg/L	<3	--	--	25 ⁽²⁰⁾	25	<3	<3	<3	<3	<3	<3	<3	<3	<3	<3	<3	<3	<3	
Selenium (Se)	µg/L	<4	10	--	1	100	<4	<4	<4	<4	<4	<4	<4	<4	<4	<4	<4	<4	<4	
Silver (Ag)	µg/L	<0.1	--	--	0.1	0.1	<0.1	<0.1	<0.1	<0.1	<0.1	<0.1	<0.1	<0.1	<0.1	<0.1	<0.1	<0.1	<0.1	
Strontium (Sr)	µg/L	<5	--	--	--	--	36	47	27	115	134	36	31	32	109	134	26	24	21	
Thallium (Tl)	µg/L	<0.3, <4	--	--	0.8	0.3	<0.3	<0.3	<0.3	<0.3	<0.3	<0.3	<0.3	<0.3	<0.3	<0.3	<0.3	<0.3	<0.3	
Titanium (Ti)	µg/L	<0.1, <2	--	--	--	--	<2	3	--	<2	<2	<2	<2	<2	<2	<2	<2	<2	<2	
Tungsten (W)	µg/L	<0.1, <10	--	--	--	30	<10	<10	<10	31	<10	<10	<10	<10	<10	15	<10	<10	<10	
Uranium (U)	µg/L	<2, <4	20	--	15	5	<2	<2	<2	<2	<2	<2	<2	<2	21	19	<2	<2	<2	
Vanadium (V)	µg/L	<0.1, <2	--	--	--	6	<2	<2	<2	<2	<2	<2	<2	<2	<2	<2	<2	<2	<2	
Zinc (Zn)	µg/L	<4, <5	--	--	30	20	<5	5	<5	<5	12	316	48	<5	36	<5	109	38	<5	
Zirconium (Zr)	µg/L	<0.1, <4	--	--	--	4	<4	<4	<4	<4	<4	<4	<4	<4	<4	<4	<4	<4	<4	
NUTRIENTS																				
Nitrate (NO ₃ ⁻)	µg/L as N	<50	10000	--	13000 ⁽²¹⁾	--	<50	--	80	190	200	610	--	450	80	--	<50	--	<50	
Nitrite (NO ₂ ⁻)	µg/L as N	<50	1000	--	60 ⁽²²⁾	--	<50	--	<50	<50	<50	<50	--	<50	<50	--	<50	--	<50	
Total Ammonia (NH ₃ + NH ₄)	µg/L as N	<20	--	--	6980	--	<20	<20	40	40	60	<20	30	20	<20	<20	<20	<20	<20	
Un-ionized Ammonia	µg/L as N	<20	--	--	19 ⁽²³⁾	20 ⁽²³⁾	<20	<20	<20	<20	<20	<20	<20	<20	<20	<20	<20	<20	<20	
NUTRIENTS																				
Free Cyanide	µg/L	<2	200	--	5	5	<2	<2	<2	<2	<2	7	<2	<2	<2	<2	3	<2	<2	
Sulphur (S)	µg/L	<50	--	--	--	--	2650	--	--	--	--	--	2070	--	--	2610	--	1510	--	

APPENDIX C
2012 Groundwater Quality Results

Parameter ⁽¹⁾	Unit	Method Detection Limit	Ontario Drinking Water Standards ⁽¹⁾⁽²⁾		Canadian Water Quality Guidelines ⁽⁴⁾	Provincial Water Quality Objective ⁽⁵⁾	North of Tailings Management Facility						North of Open Pit			Adjacent to Mine Rock Area	
			MAC	IMAC			DH12-TMF-24A			DH12-TMF-24B			DH12-WD-01			DH12-WD-12A	
							6-Jun-12	14-Aug-12	29-Nov-12	6-Jun-12	14-Aug-12	29-Nov-12	7-Jun-12	15-Aug-12	5-Dec-12	4-Jun-12	16-Aug-12
FIELD PARAMETERS																	
pH	pH units	--	--	--	6.5-9	6.5-8.5	6.48	6.87	7.51	6.95	6.16	6.11	7.64	5.5	7.78	6.14	7.14
Conductivity	µS/cm	--	--	--	--	--	527	568	787	69	63	68	--	135	76	470	810
Temperature	degrees Celsius	--	--	--	--	--	8.4	12.1	5.2	8.1	10.1	5	8.1	14.6	6.2	5.3	10.5
GENERAL PARAMETERS																	
pH	pH units	--	--	--	6.5-9	6.5-8.5	7.33	7.88	7.68	6.7	6.96	6.77	7.4	7.42	6.94	7.85	8
Alkalinity	µg/L as CaCO ₃	<5000	--	--	--	-25%	128000	200000	208000	17000	21000	21000	74000	65000	30000	133000	136000
Acidity	µg/L as CaCO ₃	<5000	--	--	--	--	<5000	<5000	<5000	<5000	<5000	<5000	<5000	<5000	<5000	<5000	<5000
Electrical Conductivity (EC)	µS/cm	<2	--	--	--	--	524	700	724	58	51	54	163	145	87	379	507
Total Suspended Solids (TSS)	µg/L	<10000	--	--	+5000-25000 ⁽⁶⁾	--	1760000	950000	1470000	26200000	4470000	6440000	1350000	160000	38000	175000	82000
Total Dissolved Solids (TDS)	µg/L	<20000	--	--	--	--	374000	454000	562000	162000	158000	76000	104000	104000	52000	380000	722000
Total Hardness	µg/L as CaCO ₃	<500	--	--	--	--	180000	267000	175000	16100	20300	20300	70700	64400	36500	131000	148000
MAJOR IONS																	
Calcium (Ca)	µg/L	<50	--	--	--	--	61500	91800	61400	4340	5500	5540	23000	22100	12400	41700	46900
Chloride (Cl)	µg/L	<100	--	--	--	--	56600	75300	59600	900	460	830	820	600	710	3900	5390
Sodium (Na)	µg/L	<50	--	--	--	--	36100	38300	85500	1940	1930	1880	3630	4900	2170	27200	55200
Fluoride (F)	µg/L	<50, <100, <50000	1500 ⁽⁷⁾	--	--	--	<50	<50	<50	<50	<50	<50	150	<50	<50	<50	<50
Magnesium (Mg)	µg/L	<50	--	--	--	--	6390	9110	5210	1290	1590	1560	3220	2240	1340	6540	7420
Potassium (K)	µg/L	<50	--	--	--	--	3440	2940	2860	580	600	740	870	780	450	1420	1580
Sulphate (SO ₄)	µg/L	<100	--	--	--	--	26900	17600	55800	2710	2540	3130	9290	10400	11000	60400	121000
METALS																	
Aluminum (Al)	µg/L	<4	--	--	100 ⁽⁸⁾	75 ⁽⁹⁾	106	40	47	159	154	133	122	37	47	13	5
Antimony (Sb)	µg/L	<6	--	6	--	20	<6	<6	<6	<6	<6	<6	<6	<6	<6	<6	<6
Arsenic (As)	µg/L	<3	--	25	5	5	<3	<3	4	<3	<3	<3	<3	<3	<3	<3	<3
Barium (Ba)	µg/L	<2	1000	--	--	--	137	78	63	8	9	9	23	7	6	11	10
Beryllium (Be)	µg/L	<1	--	--	--	11 ⁽¹⁰⁾	<1	<1	<1	<1	<1	<1	<1	<1	<1	<1	<1
Boron (B)	µg/L	<10	--	5000	1500 ⁽¹¹⁾	200	219	69	78	<10	<10	<10	<10	<10	<10	<10	<10
Cadmium (Cd)	µg/L	<0.1	--	5	0.058 ⁽¹²⁾	0.1 ⁽¹³⁾	<0.1	<0.1	<0.1	<0.1	<0.1	<0.1	0.2	<0.1	<0.1	<0.1	<0.1
Chromium (Cr)	µg/L	<3	50	--	8.9 ⁽¹⁴⁾	8.9 ⁽¹⁴⁾	<3	<3	<3	<3	<3	<3	<3	<3	<3	<3	<3
Cobalt (Co)	µg/L	<0.5	--	--	--	0.9	2.6	0.8	<0.5	0.7	0.5	0.6	0.8	1.5	0.8	<0.5	<0.5
Copper (Cu)	µg/L	<2	--	--	2 ⁽¹⁵⁾	5 ⁽¹⁶⁾	<2	<2	<2	<2	<2	<2	7	3	9	<2	<2
Iron (Fe)	µg/L	<10	--	--	300	300	1950	549	816	7790	5580	7730	45	836	24	11	<10
Lead (Pb)	µg/L	<1	10 ⁽¹⁷⁾	--	1 ⁽¹⁸⁾	3 ⁽¹⁹⁾	<1	<1	<1	<1	<1	<1	<1	<1	<1	<1	<1
Manganese (Mn)	µg/L	<2	--	--	--	--	485	385	295	146	125	132	161	300	54	16	17
Mercury (Hg)	µg/L	<0.10	1	--	0.026	0.2	<0.10	<0.1	<0.1	<0.10	<0.1	<0.1	<0.10	<0.1	<0.1	<0.10	<0.1
Molybdenum (Mo)	µg/L	<2	--	--	73	40	3	3	<2	<2	<2	<2	33	<2	<2	<2	<2
Nickel (Ni)	µg/L	<3	--	--	25 ⁽²⁰⁾	25	11	5	<3	<3	<3	<3	5	<3	<3	<3	<3
Selenium (Se)	µg/L	<4	10	--	1	100	<4	<4	<4	<4	<4	<4	<4	<4	<4	<4	<4
Silver (Ag)	µg/L	<0.1	--	--	0.1	0.1	<0.1	<0.1	<0.1	<0.1	0.1	<0.1	<0.1	<0.1	<0.1	<0.1	<0.1
Strontium (Sr)	µg/L	<5	--	--	--	--	866	998	886	38	35	36	80	48	25	65	71
Thallium (Tl)	µg/L	<0.3, <4	--	--	0.8	0.3	<0.3	<0.3	<0.3	<0.3	<0.3	<0.3	<0.3	<0.3	<0.3	<0.3	<0.3
Titanium (Ti)	µg/L	<0.1, <2	--	--	--	--	<2	<2	<2	4	<2	9	<2	4	<2	<2	<2
Tungsten (W)	µg/L	<0.1, <10	--	--	--	30	<10	<10	13	<10	<10	<10	107	25	<10	26	10
Uranium (U)	µg/L	<2, <4	20	--	15	5	<2	5	<2	<2	<2	<2	<2	<2	<2	2	2
Vanadium (V)	µg/L	<0.1, <2	--	--	--	6	<2	2	<2	16	6	18	2	<2	<2	<2	<2
Zinc (Zn)	µg/L	<4, <5	--	--	30	20	447	<5	<5	81	5	14	864	<5	9	39	6
Zirconium (Zr)	µg/L	<0.1, <4	--	--	--	4	<4	<4	<4	<4	<4	<4	<4	<4	<4	<4	<4
NUTRIENTS																	
Nitrate (NO ₃ ⁻)	µg/L as N	<50	10000	--	13000 ⁽²¹⁾	--	<50	--	<50	100	--	<50	60	--	<50	<50	--
Nitrite (NO ₂ ⁻)	µg/L as N	<50	1000	--	60 ⁽²²⁾	--	<50	--	<50	<50	--	<50	<50	--	<50	<50	--
Total Ammonia (NH ₃ + NH ₄)	µg/L as N	<20	--	--	6980	--	<20	30	40	60	30	50	<20	<20	<20	<20	<20
Un-ionized Ammonia	µg/L as N	<20	--	--	19 ⁽²³⁾	20 ⁽²³⁾	<20	<20	<20	<20	<20	<20	<20	<20	<20	<20	<20
NUTRIENTS																	
Free Cyanide	µg/L	<2	200	--	5	5	<2	<2	<2	<2	<2	<2	6	<2	<2	<2	<2
Sulphur (S)	µg/L	<50	--	--	--	--	9370	--	--	900	--	--	3220	--	--	19200	--

APPENDIX C
2012 Groundwater Quality Results

Parameter ⁽¹⁾	Unit	Method Detection Limit	Ontario Drinking Water Standards ⁽¹⁾⁽²⁾		Canadian Water Quality Guidelines ⁽⁴⁾	Provincial Water Quality Objective ⁽⁵⁾	Adjacent to Mine Rock Area									West of Open Pit		
			MAC	IMAC			DH12-WD-12B		DH12-WD-14			DH12-WD-17A			DH12-WD-19			
							4-Jun-12	16-Aug-12	4-Jun-12	14-Aug-12	5-Dec-12	5-Jun-12	15-Aug-12	5-Dec-12	4-Jun-12	15-Aug-12	5-Dec-12	
FIELD PARAMETERS																		
pH	pH units	--	--	--	6.5-9	6.5-8.5	7.09	7.08	7.85	7.12	8.05	8.44	6.04	8.02	7.65	7.22	7.63	
Conductivity	µs/cm	--	--	--	--	--	227	229	228	206	206	236	312	351	405	373	441	
Temperature	degrees Celsius	--	--	--	--	--	4.9	10	10.1	11.2	7.4	10.1	9	--	9.7	13.2	6.6	
GENERAL PARAMETERS																		
pH	pH units	--	--	--	6.5-9	6.5-8.5	7.84	8.08	7.76	7.99	7.85	7.73	7.95	8.02	7.89	8.01	8.06	
Alkalinity	µg/L as CaCO3	<5000	--	--	--	-25%	119000	120000	111000	103000	101000	109000	114000	133000	213000	198000	209000	
Acidity	µg/L as CaCO3	<5000	--	--	--	--	<5000	<5000	<5000	<5000	<5000	<5000	<5000	<5000	<5000	<5000	<5000	
Electrical Conductivity (EC)	µS/cm	<2	--	--	--	--	240	249	227	215	215	308	303	362	410	378	430	
Total Suspended Solids (TSS)	µg/L	<10000	--	--	+5000-25000 ⁽⁶⁾	--	40000	100000	223000	256000	112000	38000	592000	102000	266000	187000	793000	
Total Dissolved Solids (TDS)	µg/L	<20000	--	--	--	--	146000	172000	130000	138000	116000	146000	240000	208000	236000	244000	542000	
Total Hardness	µg/L as CaCO3	<500	--	--	--	--	104000	129000	98600	104000	98900	93200	104000	107000	206000	205000	189000	
MAJOR IONS																		
Calcium (Ca)	µg/L	<50	--	--	--	--	32400	40100	31900	33800	32100	29300	32200	32600	66100	66300	62300	
Chloride (Cl)	µg/L	<100	--	--	--	--	900	870	1040	940	1060	10800	13000	21300	1890	960	3260	
Sodium (Na)	µg/L	<50	--	--	--	--	4640	4630	6500	6290	6010	26900	24800	35700	4660	3850	24600	
Fluoride (F)	µg/L	<50, <100, <50000	1500 ⁽⁷⁾	--	--	--	<50	<50	140	<50	100	<50	<50	<50	<50	<50	<50	
Magnesium (Mg)	µg/L	<50	--	--	--	--	5550	6940	4590	4810	4550	4860	5660	6330	10000	9700	8240	
Potassium (K)	µg/L	<50	--	--	--	--	1520	1700	1220	1190	1060	1020	1370	1170	1650	1720	1770	
Sulphate (SO ₄)	µg/L	<100	--	--	--	--	10200	13600	9890	10900	10700	32700	24200	26600	12400	11100	29000	
METALS																		
Aluminum (Al)	µg/L	<4	--	--	100 ⁽⁸⁾	75 ⁽⁹⁾	21	8	13	7	10	63	25	13	18	13	14	
Antimony (Sb)	µg/L	<6	--	6	--	20	<6	<6	<6	<6	<6	<6	<6	<6	<6	<6	<6	
Arsenic (As)	µg/L	<3	--	25	5	5	<3	<3	<3	<3	<3	<3	<3	<3	<3	<3	<3	
Barium (Ba)	µg/L	<2	1000	--	--	--	14	13	22	10	17	35	77	50	23	29	41	
Beryllium (Be)	µg/L	<1	--	--	--	11 ⁽¹⁰⁾	<1	<1	<1	<1	<1	<1	<1	<1	<1	<1	<1	
Boron (B)	µg/L	<10	--	5000	1500 ⁽¹¹⁾	200	<10	<10	16	20	22	11	14	27	<10	<10	12	
Cadmium (Cd)	µg/L	<0.1	--	5	0.058 ⁽¹²⁾	0.1 ⁽¹³⁾	<0.1	<0.1	0.1	<0.1	<0.1	0.1	<0.1	<0.1	<0.1	<0.1	<0.1	
Chromium (Cr)	µg/L	<3	50	--	8.9 ⁽¹⁴⁾	8.9 ⁽¹⁴⁾	<3	<3	<3	<3	<3	<3	<3	<3	<3	<3	<3	
Cobalt (Co)	µg/L	<0.5	--	--	--	0.9	<0.5	<0.5	0.5	<0.5	<0.5	<0.5	0.5	<0.5	<0.5	<0.5	<0.5	
Copper (Cu)	µg/L	<2	--	--	2 ⁽¹⁵⁾	5 ⁽¹⁶⁾	<2	2	<2	<2	<2	2	4	3	<2	<2	<2	
Iron (Fe)	µg/L	<10	--	--	300	300	79	32	<10	<10	57	39	<10	16	<10	<10	52	
Lead (Pb)	µg/L	<1	10 ⁽¹⁷⁾	--	1 ⁽¹⁸⁾	3 ⁽¹⁹⁾	<1	<1	<1	<1	<1	<1	<1	<1	<1	<1	<1	
Manganese (Mn)	µg/L	<2	--	--	--	--	61	58	46	17	59	85	98	113	96	101	181	
Mercury (Hg)	µg/L	<0.10	1	--	0.026	0.2	<0.10	<0.1	<0.10	<0.1	<0.1	<0.10	<0.1	<0.1	<0.10	<0.1	<0.1	
Molybdenum (Mo)	µg/L	<2	--	--	73	40	3	2	7	6	8	13	11	7	<2	<2	<2	
Nickel (Ni)	µg/L	<3	--	--	25 ⁽²⁰⁾	25	<3	<3	<3	<3	<3	<3	7	13	<3	3	<3	
Selenium (Se)	µg/L	<4	10	--	1	100	<4	<4	<4	<4	<4	<4	<4	<4	<4	<4	<4	
Silver (Ag)	µg/L	<0.1	--	--	0.1	0.1	<0.1	<0.1	<0.1	<0.1	<0.1	<0.1	<0.1	<0.1	<0.1	<0.1	<0.1	
Strontium (Sr)	µg/L	<5	--	--	--	--	47	50	57	58	65	51	54	89	142	149	151	
Thallium (Tl)	µg/L	<0.3, <4	--	--	0.8	0.3	<0.3	<0.3	<0.3	<0.3	<0.3	<0.3	<0.3	<0.3	<0.3	<0.3	<0.3	
Titanium (Ti)	µg/L	<0.1, <2	--	--	--	--	<2	<2	<2	<2	<2	<2	<2	<2	<2	<2	<2	
Tungsten (W)	µg/L	<0.1, <10	--	--	--	30	426	259	28	12	34	677	647	42	<10	<10	20	
Uranium (U)	µg/L	<2, <4	20	--	15	5	3	3	4	4	3	<2	<2	2	<2	<2	4	
Vanadium (V)	µg/L	<0.1, <2	--	--	--	6	<2	<2	<2	<2	<2	<2	<2	<2	<2	<2	<2	
Zinc (Zn)	µg/L	<4, <5	--	--	30	20	27	8	32	12	<5	262	142	17	19	<5	8	
Zirconium (Zr)	µg/L	<0.1, <4	--	--	--	4	<4	<4	<4	<4	<4	<4	<4	<4	<4	<4	<4	
NUTRIENTS																		
Nitrate (NO ₃ ⁻)	µg/L as N	<50	10000	--	13000 ⁽²¹⁾	--	<50	--	<50	--	<50	190	--	<50	<50	--	<50	
Nitrite (NO ₂ ⁻)	µg/L as N	<50	1000	--	60 ⁽²²⁾	--	<50	--	<50	--	<50	<50	--	<50	<50	--	<50	
Total Ammonia (NH ₃ + NH ₄)	µg/L as N	<20	--	--	6980	--	<20	<20	<20	<20	40	<20	20	50	<20	<20	50	
Un-ionized Ammonia	µg/L as N	<20	--	--	19 ⁽²³⁾	20 ⁽²³⁾	<20	<20	<20	<20	<20	<20	<20	<20	<20	<20	<20	
NUTRIENTS																		
Free Cyanide	µg/L	<2	200	--	5	5	<2	<2	<2	<2	<2	<2	<2	<2	<2	<2	<2	
Sulphur (S)	µg/L	<50	--	--	--	--	3200	--	3280	--	--	10700	--	--	4190	--	--	

APPENDIX C
2012 Groundwater Quality Results

Parameter ⁽¹⁾	Unit	Method Detection Limit	Ontario Drinking Water Standards ⁽¹⁾⁽²⁾		Canadian Water Quality Guidelines ⁽⁴⁾	Provincial Water Quality Objective ⁽⁵⁾	Adjacent to Mine Rock Area			North of Open Pit								
			MAC	IMAC			DH12-WD-23			DH12-WD-01			DH12-WD-25A			DH12-WD-25B		
							5-Jun-12	15-Aug-12	5-Dec-12	7-Jun-12	15-Aug-12	5-Dec-12	13-Jun-12	16-Aug-12	5-Dec-12	13-Jun-12	16-Aug-12	5-Dec-12
FIELD PARAMETERS																		
pH	pH units	--	--	--	6.5-9	6.5-8.5	7.65	5.87	6.97	7.64	5.5	7.78	6.68	6.05	7.42	6.4	5.8	7.3
Conductivity	µs/cm	--	--	--	--	--	339	308	330	--	135	76	163	167	152	214	254	266
Temperature	degrees Celsius	--	--	--	--	--	1.6	11.6	6	8.1	14.6	6.2	8.3	10.1	4.8	8.4	10.8	5
GENERAL PARAMETERS																		
pH	pH units	--	--	--	6.5-9	6.5-8.5	7.93	8.05	7.96	7.4	7.42	6.94	7.53	7.64	7.31	7.7	7.79	7.68
Alkalinity	µg/L as CaCO3	<5000	--	--	--	-25%	181000	168000	167000	74000	65000	30000	81000	70000	70000	118000	135000	132000
Acidity	µg/L as CaCO3	<5000	--	--	--	--	<5000	<5000	<5000	<5000	<5000	<5000	<5000	<5000	<5000	<5000	<5000	<5000
Electrical Conductivity (EC)	µS/cm	<2	--	--	--	--	331	305	313	163	145	87	180	154	150	226	256	253
Total Suspended Solids (TSS)	µg/L	<10000	--	--	+5000-25000 ⁽⁶⁾	--	1910000	2140000	15000000	1350000	160000	38000	624000	736000	211000	19500000	4660000	5770000
Total Dissolved Solids (TDS)	µg/L	<20000	--	--	--	--	206000	202000	208000	104000	104000	52000	114000	98000	102000	154000	<20000	178000
Total Hardness	µg/L as CaCO3	<500	--	--	--	--	185000	183000	173000	70700	64400	36500	81900	81900	74100	123000	135000	128000
MAJOR IONS																		
Calcium (Ca)	µg/L	<50	--	--	--	--	59900	58400	56100	23000	22100	12400	25300	25000	23000	41100	44800	42800
Chloride (Cl)	µg/L	<100	--	--	--	--	670	520	810	820	600	710	590	550	760	690	670	810
Sodium (Na)	µg/L	<50	--	--	--	--	2170	2400	2040	3630	4900	2170	1680	1590	1490	4520	6610	4790
Fluoride (F)	µg/L	<50, <100, <50000	1500 ⁽⁷⁾	--	--	--	<50	<50	<50	150	<50	<50	<50	<50	<50	<50	<50	<50
Magnesium (Mg)	µg/L	<50	--	--	--	--	8560	8960	7930	3220	2240	1340	4550	4730	4050	4900	5700	5010
Potassium (K)	µg/L	<50	--	--	--	--	1910	2160	2010	870	780	450	860	940	470	770	640	590
Sulphate (SO ₄)	µg/L	<100	--	--	--	--	100	100	100	9290	10400	11000	8410	8170	6730	5210	770	1570
METALS																		
Aluminum (Al)	µg/L	<4	--	--	100 ⁽⁸⁾	75 ⁽⁹⁾	23	9	20	122	37	47	31	24	31	209	43	20
Antimony (Sb)	µg/L	<6	--	6	--	20	<6	<6	<6	<6	<6	<6	<6	<6	<6	<6	<6	<6
Arsenic (As)	µg/L	<3	--	25	5	5	<3	<3	<3	<3	<3	<3	8	14	11	6	4	4
Barium (Ba)	µg/L	<2	1000	--	--	--	27	27	30	23	7	6	5	7	7	17	26	23
Beryllium (Be)	µg/L	<1	--	--	--	11 ⁽¹⁰⁾	<1	<1	<1	<1	<1	<1	<1	<1	<1	<1	<1	<1
Boron (B)	µg/L	<10	--	5000	1500 ⁽¹¹⁾	200	<10	<10	<10	<10	<10	<10	<10	<10	<10	<10	<10	<10
Cadmium (Cd)	µg/L	<0.1	--	5	0.058 ⁽¹²⁾	0.1 ⁽¹³⁾	<0.1	<0.1	<0.1	0.2	<0.1	<0.1	<0.1	<0.1	<0.1	<0.1	<0.1	<0.1
Chromium (Cr)	µg/L	<3	50	--	8.9 ⁽¹⁴⁾	8.9 ⁽¹⁴⁾	<3	<3	<3	<3	<3	<3	<3	<3	<3	<3	<3	<3
Cobalt (Co)	µg/L	<0.5	--	--	--	0.9	<0.5	<0.5	<0.5	0.8	1.5	0.8	<0.5	<0.5	<0.5	<0.5	<0.5	<0.5
Copper (Cu)	µg/L	<2	--	--	2 ⁽¹⁵⁾	5 ⁽¹⁶⁾	<2	<2	<2	7	3	9	<2	<2	<2	<2	<2	<2
Iron (Fe)	µg/L	<10	--	--	300	300	1430	1510	1900	45	836	24	4400	4200	4360	3440	3210	4540
Lead (Pb)	µg/L	<1	10 ⁽¹⁷⁾	--	1 ⁽¹⁸⁾	3 ⁽¹⁹⁾	<1	<1	<1	<1	<1	<1	<1	<1	<1	<1	<1	<1
Manganese (Mn)	µg/L	<2	--	--	--	--	166	156	191	161	300	54	268	300	287	390	366	431
Mercury (Hg)	µg/L	<0.10	1	--	0.026	0.2	<0.10	<0.1	<0.1	<0.10	<0.1	<0.1	<0.1	<0.1	<0.1	<0.1	<0.1	<0.1
Molybdenum (Mo)	µg/L	<2	--	--	73	40	8	2	4	33	<2	<2	<2	<2	<2	<2	<2	<2
Nickel (Ni)	µg/L	<3	--	--	25 ⁽²⁰⁾	25	<3	<3	<3	5	<3	<3	<3	<3	<3	<3	<3	<3
Selenium (Se)	µg/L	<4	10	--	1	100	<4	<4	<4	<4	<4	<4	<4	<4	<4	<4	<4	<4
Silver (Ag)	µg/L	<0.1	--	--	0.1	0.1	<0.1	<0.1	<0.1	<0.1	<0.1	<0.1	<0.1	<0.1	<0.1	<0.1	<0.1	<0.1
Strontium (Sr)	µg/L	<5	--	--	--	--	58	56	60	80	48	25	46	48	49	60	70	74
Thallium (Tl)	µg/L	<0.3, <4	--	--	0.8	0.3	<0.3	<0.3	<0.3	<0.3	<0.3	<0.3	<0.3	<0.3	<0.3	<0.3	<0.3	<0.3
Titanium (Ti)	µg/L	<0.1, <2	--	--	--	--	<2	<2	<2	<2	<2	<2	<2	<2	<2	11	<2	<2
Tungsten (W)	µg/L	<0.1, <10	--	--	--	30	21	<10	<10	107	25	<10	<10	<10	<10	<10	<10	<10
Uranium (U)	µg/L	<2, <4	20	--	15	5	<2	<2	<2	<2	<2	<2	<2	<2	<2	<2	<2	<2
Vanadium (V)	µg/L	<0.1, <2	--	--	--	6	2	<2	2	2	<2	<2	<2	<2	<2	<2	<2	<2
Zinc (Zn)	µg/L	<4, <5	--	--	30	20	37	<5	<5	864	<5	9	10	11	<5	16	24	<5
Zirconium (Zr)	µg/L	<0.1, <4	--	--	--	4	<4	<4	<4	<4	<4	<4	<4	<4	<4	<4	<4	<4
NUTRIENTS																		
Nitrate (NO ₃ ⁻)	µg/L as N	<50	10000	--	13000 ⁽²¹⁾	--	<50	--	<50	60	--	<50	<50	--	<50	<50	--	<50
Nitrite (NO ₂ ⁻)	µg/L as N	<50	1000	--	60 ⁽²²⁾	--	<50	--	<50	<50	--	<50	<50	--	<50	<50	--	<50
Total Ammonia (NH ₃ + NH ₄)	µg/L as N	<20	--	--	6980	--	80	70	280	<20	<20	<20	<20	40	60	170	360	200
Un-ionized Ammonia	µg/L as N	<20	--	--	19 ⁽²³⁾	20 ⁽²³⁾	<20	<20	<20	<20	<20	<20	<20	<20	<20	<20	<20	<20
NUTRIENTS																		
Free Cyanide	µg/L	<2	200	--	5	5	<2	<2	<2	6	<2	<2	<2	2	<2	<2	2	<2
Sulphur (S)	µg/L	<50	--	--	--	--	140	--	--	3220	--	--	--	--	--	--	--	--

APPENDIX C
2012 Groundwater Quality Results

Parameter ⁽¹⁾	Unit	Method Detection Limit	Ontario Drinking Water Standards ⁽¹⁾⁽²⁾		Canadian Water Quality Guidelines ⁽⁴⁾	Provincial Water Quality Objective ⁽⁵⁾	North of Open Pit			West of Open Pit					
			MAC	IMAC			DH12-WD-26			DH12-WD-27A			DH12-WD-27B		
							13-Jun-12	15-Aug-12	5-Dec-12	4-Jun-12	15-Aug-12	5-Dec-12	4-Jun-12	15-Aug-12	5-Dec-12
FIELD PARAMETERS															
pH	pH units	--	--	--	6.5-9	6.5-8.5	7.43	7.1	7.58	7.61	6.61	8.08	7.43	6.97	7.97
Conductivity	µs/cm	--	--	--	--	--	389	315	299	289	252	237	239	273	272
Temperature	degrees Celsius	--	--	--	--	--	8.9	13.6	6.3	9	9.5	4.8	8.2	8.7	4.8
GENERAL PARAMETERS															
pH	pH units	--	--	--	6.5-9	6.5-8.5	7.83	7.78	7.84	7.87	8.08	7.94	7.85	8.13	8.01
Alkalinity	µg/L as CaCO ₃	<5000	--	--	--	-25%	135000	145000	150000	152000	122000	120000	125000	136000	134000
Acidity	µg/L as CaCO ₃	<5000	--	--	--	--	<5000	<5000	<5000	<5000	<5000	<5000	<5000	<5000	<5000
Electrical Conductivity (EC)	µS/cm	<2	--	--	--	--	372	331	306	294	248	246	259	271	272
Total Suspended Solids (TSS)	µg/L	<10000	--	--	+5000-25000 ⁽⁶⁾	--	602000	104000	41000	2700000	1210000	312000	6100000	3960000	2180000
Total Dissolved Solids (TDS)	µg/L	<20000	--	--	--	--	270000	216000	208000	170000	160000	148000	152000	176000	608000
Total Hardness	µg/L as CaCO ₃	<500	--	--	--	--	112000	121000	94900	146000	136000	117000	114000	157000	136000
MAJOR IONS															
Calcium (Ca)	µg/L	<50	--	--	--	--	37700	40100	32100	42200	39000	33700	33100	45200	39400
Chloride (Cl)	µg/L	<100	--	--	--	--	3420	2850	2740	800	680	710	800	710	860
Sodium (Na)	µg/L	<50	--	--	--	--	46100	30000	29600	2930	4660	4250	8120	3110	2600
Fluoride (F)	µg/L	<50, <100, <50000	1500 ⁽⁷⁾	--	--	--	300	290	250	<50	100	110	170	<50	<50
Magnesium (Mg)	µg/L	<50	--	--	--	--	4340	5030	3590	9850	9490	7980	7630	10700	9080
Potassium (K)	µg/L	<50	--	--	--	--	990	1220	820	1130	1230	910	1070	1230	960
Sulphate (SO ₄)	µg/L	<100	--	--	--	--	59200	24400	9910	12100	12800	12600	14200	12700	12200
METALS															
Aluminum (Al)	µg/L	<4	--	--	100 ⁽⁸⁾	75 ⁽⁹⁾	9	9	15	15	21	7	154	102	8
Antimony (Sb)	µg/L	<6	--	6	--	20	<6	<6	<6	<6	<6	<6	<6	<6	<6
Arsenic (As)	µg/L	<3	--	25	5	5	5	4	4	<3	<3	<3	<3	<3	<3
Barium (Ba)	µg/L	<2	1000	--	--	--	14	15	17	15	16	21	17	16	14
Beryllium (Be)	µg/L	<1	--	--	--	11 ⁽¹⁰⁾	<1	<1	<1	<1	<1	<1	<1	<1	<1
Boron (B)	µg/L	<10	--	5000	1500 ⁽¹¹⁾	200	13	12	17	<10	<10	10	<10	<10	<10
Cadmium (Cd)	µg/L	<0.1	--	5	0.058 ⁽¹²⁾	0.1 ⁽¹³⁾	<0.1	<0.1	<0.1	0.1	<0.1	<0.1	<0.1	<0.1	<0.1
Chromium (Cr)	µg/L	<3	50	--	8.9 ⁽¹⁴⁾	8.9 ⁽¹⁴⁾	<3	<3	<3	<3	<3	<3	<3	<3	<3
Cobalt (Co)	µg/L	<0.5	--	--	--	0.9	<0.5	<0.5	<0.5	<0.5	<0.5	<0.5	<0.5	<0.5	<0.5
Copper (Cu)	µg/L	<2	--	--	2 ⁽¹⁵⁾	5 ⁽¹⁶⁾	<2	<2	<2	<2	<2	<2	5	<2	<2
Iron (Fe)	µg/L	<10	--	--	300	300	1280	1440	1340	89	<10	<10	154	61	28
Lead (Pb)	µg/L	<1	10 ⁽¹⁷⁾	--	1 ⁽¹⁸⁾	3 ⁽¹⁹⁾	<1	<1	<1	<1	<1	<1	<1	<1	<1
Manganese (Mn)	µg/L	<2	--	--	--	--	263	279	257	47	57	53	63	36	16
Mercury (Hg)	µg/L	<0.10	1	--	0.026	0.2	<0.1	<0.1	<0.1	<0.10	<0.1	<0.1	<0.10	<0.1	<0.1
Molybdenum (Mo)	µg/L	<2	--	--	73	40	12	6	8	<2	<2	<2	<2	<2	<2
Nickel (Ni)	µg/L	<3	--	--	25 ⁽²⁰⁾	25	<3	<3	<3	<3	<3	<3	<3	<3	<3
Selenium (Se)	µg/L	<4	10	--	1	100	<4	<4	<4	<4	<4	<4	<4	<4	<4
Silver (Ag)	µg/L	<0.1	--	--	0.1	0.1	<0.1	<0.1	<0.1	<0.1	<0.1	<0.1	<0.1	<0.1	<0.1
Strontium (Sr)	µg/L	<5	--	--	--	--	73	83	66	52	87	144	75	60	54
Thallium (Tl)	µg/L	<0.3, <4	--	--	0.8	0.3	<0.3	<0.3	<0.3	<0.3	<0.3	<0.3	<0.3	<0.3	<0.3
Titanium (Ti)	µg/L	<0.1, <2	--	--	--	--	2	<2	<2	<2	<2	<2	5	<2	<2
Tungsten (W)	µg/L	<0.1, <10	--	--	--	30	29	14	11	<10	<10	<10	<10	<10	<10
Uranium (U)	µg/L	<2, <4	20	--	15	5	<2	<2	<2	<2	<2	<2	<2	3	2
Vanadium (V)	µg/L	<0.1, <2	--	--	--	6	3	3	3	<2	<2	<2	<2	<2	<2
Zinc (Zn)	µg/L	<4, <5	--	--	30	20	227	<5	<5	6	28	<5	21	166	<5
Zirconium (Zr)	µg/L	<0.1, <4	--	--	--	4	<4	<4	<4	<4	<4	<4	<4	<4	<4
NUTRIENTS															
Nitrate (NO ₃ ⁻)	µg/L as N	<50	10000	--	13000 ⁽²¹⁾	--	<50	--	<50	<50	--	<50	<50	--	<50
Nitrite (NO ₂ ⁻)	µg/L as N	<50	1000	--	60 ⁽²²⁾	--	<50	--	<50	<50	--	<50	<50	--	<50
Total Ammonia (NH ₃ + NH ₄)	µg/L as N	<20	--	--	6980	--	80	20	110	<20	60	110	120	20	40
Un-Ionized Ammonia	µg/L as N	<20	--	--	19 ⁽²³⁾	20 ⁽²³⁾	<20	<20	<20	<20	<20	<20	<20	<20	<20
NUTRIENTS															
Free Cyanide	µg/L	<2	200	--	5	5	<2	2	<2	<2	<2	<2	<2	<2	<2
Sulphur (S)	µg/L	<50	--	--	--	--	--	--	--	4080	--	--	4820	--	--

NOTES ON COMPARISONS TO WATER QUALITY STANDARDS AND GUIDELINES:

Values in GREY exceed the ODWSs MACs or IMACs

Values in ***bold italics*** exceed the CCME CWQGs

Values underlined exceed the PWQOs

-- indicates no value available

NOTES ON WATER QUALITY STANDARDS AND GUIDELINES:

(1) Total concentrations are assumed, unless stated otherwise.

(2) Ontario Regulation (O.Reg.) 169/03: Ontario Drinking Water Standards (ODWS). Last amendment: O.Reg. 327/08.

http://www.e-laws.gov.on.ca/html/regs/english/elaws_regs_030169_e.htm.

(3) MAC: Maximum Acceptable Concentration; IMAC: Interim Maximum Acceptable Concentration

(4) Canadian Council of Ministers of the Environment (CCME), Canadian Water Quality Guidelines (CWQGs) for the Protection of Aquatic Life, Update 7.1 (December 2007).

(5) Provincial Water Quality Objectives, Ministry of Environment and Energy (1994, Revised 1999).

(6) TSS (CWQG) Under clear flow: + 25 mg/L from background levels for any short-term exposure (e.g., 24-h period).

average + 5 mg/L from background levels for longer term exposures (24 h < discharge < 30 d).

TSS (CWQG) Under high flow: + 25 mg/L from background levels at any time when background levels between 25 and 250 mg/L.

+ 10% of background levels when background is >250 mg/L.

(7) Where fluoride is added to drinking water, it is recommended that the concentration be adjusted to 0.5-0.8 mg/L the optimum level for control of tooth decay. Where supplies contain naturally occurring fluoride at levels higher than 1.5 mg/L but less than 2.4 mg/L the Ministry of Health and Long Term Care recommends an approach through local boards of health to raise public and professional awareness to control excessive exposure to fluoride from other sources.

(8) Aluminium guideline (CWQG) is calculated assuming a pH of 7.0.

(9) Aluminium guideline (PWQO) is calculated assuming a pH of 7.0.

(10) Beryllium guideline (PWQO) is calculated assuming a hardness of 30 mg/L as CaCO₃.

(11) Boron guideline (CWQG) is based on long-term exposure.

(12) Cadmium guideline (CWQG) is based on the Draft Scientific Criteria Document for the Development of the Canadian Water Quality Guidelines for the Protection of Aquatic Life: Cadmium, October 2012, and calculated using an assumed hardness of 30 mg/L as CaCO₃.

(13) Cadmium guideline (PWQO) is calculated assuming a hardness of 30 mg/L as CaCO₃.

(14) No guidelines for total chromium. Guidelines for trivalent chromium used: CWQG and PWQO guidelines for Cr(III) are both 8.9 µg/L.

(15) Copper guideline (CWQG) is calculated assuming a hardness of 30 mg/L as CaCO₃.

(16) Copper guideline (PWQO) is calculated assuming a hardness of 30 mg/L as CaCO₃.

(17) This standard applies to water at the point of consumption. Since lead is a component in some plumbing systems, first flush water may contain higher concentrations of lead than water that has been flushed for five minutes.

(18) Lead guideline (CWQG) is calculated assuming a hardness of 30 mg/L as CaCO₃.

(19) Lead guideline (PWQO) is calculated assuming a hardness of 30 mg/L as CaCO₃.

(20) Nickel guideline (CCME) is calculated assuming a hardness of 30 mg/L as CaCO₃.

(21) For protection from direct toxic effects, the guidelines do not consider indirect effects due to eutrophication.

(22) Guideline is expressed as µg nitrite-nitrogen/L. This value is equivalent to 197 µg nitrite/L.

(23) Un-ionized ammonia is calculated using the equation: $f = 1/(10^{pKa-pH} + 1)$, where f is the fraction of NH₃; $pKa = 0.09018 + 2729.92/T$; T = ambient water temperature in Kelvin ($K = °C + 273.16$) (Emerson et al., 1975)



APPENDIX D

Quality Assurance/Quality Control



INTRODUCTION

As part of the review of the data from the Quality Assurance/Quality Control (QA/QC) samples, the following were taken into consideration to identify potential issues:

- lab, field and/or trip blank(s) showing detectable parameter concentrations and/or values outside criteria ranges;
- uncharacteristically high, anomalous concentrations; and
- duplicate samples having significantly different results.

SURFACE WATER QUALITY ASSURANCE/QUALITY CONTROL

Blanks

The field blanks that had detectable parameters, and/or values that were not within acceptable Canadian Water Quality Guidelines (CWQG) and Provincial Water Quality Objectives (PWQO) ranges are as follows:

- Total zinc concentration above PWQO (20 µg/L) in blanks on January 24, 2012 (26 µg/L) and above PWQO and CWQG (30 µg/L) on September 24, 2012 (45 µg/L).
- Total phosphorus concentrations at or above PWQO (20 µg/L) in blanks from August 20, 2012 (30 µg/L) and September 24, 2012 (20 µg/L).

Blind Duplicates

The analytical data for the blind duplicate samples (collected at the same time and in the same location as surface water samples) were reviewed. In order to provide a quantitative measure of the precision of duplicate analysis, the relative percent difference (RPD) is calculated as follows:

$$RPD = \frac{|x_1 - x_2|}{x_m} \times 100\%$$

Where x_1 = initial sample result

x_2 = duplicate sample result

x_m = mean of x_1 , x_2

The results of this review indicated that the baseline monitoring program analytical data were of acceptable quality, with the exception of the parameters listed in Table 1, which had a higher than acceptable difference (i.e. >30%). It should be noted that it is not uncommon to have RPDs as high as 200% for results near the detection limit.



APPENDIX D - REVISED
Quality Assurance/Quality Control Review

Table 1: Quality Assurance/Quality Control Blind Duplicates with Relative Percent Difference >30%

Sample Location	Sampling Date	Parameter (units)	Sample Concentration	Duplicate Concentration	Detection Limit	
SL	May 31, 2012	TDS (µg/L)	56,000	80,000	20,000	
	July 18, 2012	Iron (µg/L)	34	50	10	
		Manganese (µg/L)	33	45	2	
		Zinc (µg/L)	<5	65	5	
		Total Phosphorus (µg/L)	<20	30	20	
	August 20, 2012	Electrical Conductivity (µS/cm)	60	43	2	
		Potassium (µg/L)	310	720	50	
	September 24, 2012	TSS (µg/L)	<1000	2000	1000	
		Zinc (µg/L)	7	<5	5	
	January 29, 2013	Chloride (µg/L)	380	740	100	
		DOC (µg/L)	8500	14200	500	
		Dissolved Aluminum (µg/L)	28	96	4	
		Sodium (µg/L)	730	1170	50	
		Barium (µg/L)	7	5	2	
		Iron (µg/L)	41	176	10	
	February 24, 2013	Manganese (µg/L)	23	10	2	
		Alkalinity (µg/L)	28000	16000	5000	
		Dissolved Organic Carbon (µg/L)	8200	13500	500	
		Chloride (µg/L)	340	910	100	
		Total Ammonia (µg/L)	520	300	20	
		Calcium (µg/L)	10400	7460	50	
		Sodium (µg/L)	780	1110	50	
		Dissolved Aluminum (µg/L)	30	58	4	
BPD	May 31, 2012	Manganese (µg/L)	39	10	2	
		Strontium (µg/L)	24	13	5	
3D-c	June 28, 2012	Zinc (µg/L)	6	44	5	
		Total Cyanide (µg/L)	<2	12	2	
		Dissolved Aluminum (µg/L)	43	30	4	
		Barium (µg/L)	4	6	2	
		Manganese (µg/L)	22	36	2	
		Strontium (µg/L)	12	25	5	
	July 18, 2012	Zinc (µg/L)	24	320	5	
		Zinc (µg/L)	20	7	5	
		August 20, 2012	Total Phosphorus (µg/L)	<20	40	20
		September 24, 2012	TSS (µg/L)	<1000	2000	1000
November 19, 2012	Zinc (µg/L)	7	<5	5		



APPENDIX D - REVISED

Quality Assurance/Quality Control Review

Sample Location	Sampling Date	Parameter (units)	Sample Concentration	Duplicate Concentration	Detection Limit
	January 29, 2013	Zinc (µg/L)	17	11	5
	February 2013	Chloride (µg/L)	880	380	100
		Iron (µg/L)	107	159	10
		Magnesium (µg/L)	1360	1870	50
		Zinc (µg/L)	43	9	5
CHLK	June 25, 2012	Zinc (µg/L)	<5	16	5
MESO-LS2	May 2013	Total Dissolved Solids (µg/L)	56000	84000	20000
		Nitrate	100	70	50
		Iron	200	300	10
		Zinc	5	48	5

Comparison of Total and Dissolved Metals

Laboratory analytical certificates of total and dissolved metal concentrations in surface water samples collected in 2012 and 2013 were reviewed and the total and dissolved concentrations were compared. Total metals concentrations were typically higher than the dissolved concentrations, with the exception of the parameters listed below (it should be noted that the instances where the dissolved metal concentration is only slightly higher than the total concentration, or near the laboratory detection limit, may be within the range of laboratory error):

- Dissolved zinc concentration (21 µg/L) was higher than the total zinc concentration (5 µg/L) at station P-6 in July 2012.
- Dissolved barium was higher than total barium at stations BL-B (15 µg/L vs. 5 µg/L), L-2 (10 µg/L vs. 3 µg/L), SL (11 µg/L vs. 5 µg/L and 27 µg/L vs. 6 µg/L in a duplicate sample), BPD (14 µg/L vs. 5 µg/L), LCM (34 µg/L vs. 8 µg/L), CHLK (15 µg/L vs. 4 µg/L), MP (13 µg/L vs. 11 µg/L), 3D-c (9 µg/L vs. 3 µg/L) in July 2012.
- Dissolved iron was higher than total iron at station BPD (14 µg/L vs. <10 µg/L) in July 2012.
- Dissolved boron was higher than total boron at station MP (16 µg/L vs 13 µg/L) in July 2012.

Additional QA/QC Analysis

As part of an additional QA/QC analysis conducted by IAMGOLD in spring 2013, a subset of samples were submitted to two different laboratories. Samples collected from the following locations on March 19, 2013, were submitted for analysis at both Testmark Laboratories Ltd. (Testmark) and AGAT Laboratories (AGAT):

- CL, LCM, 3D-c, CHLK, P-6 and MESO-OUT.

The RPD of the parameter concentrations measured at Testmark and AGAT were compared. The parameter concentrations below had a higher than acceptable RPD (i.e. >30%) are presented in Table 2.



Table 2: Quality Assurance/Quality Control, Laboratory Blind Duplicates with Relative Percent Difference >30%

Station	Parameter	Concentration (µg/L) Analyzed at Testmark	Concentration (µg/L) Analyzed at AGAT	Detection Limit (AGAT)	Detection Limit (Testmark)
CL	Zinc	10.4	106	5	1
LCM	Magnesium	486	840	50	4
	Zinc	1.2	11	5	1
3D-c	Magnesium	854	1180	50	4
	Zinc	3.2	5	5	1
CHLK	Magnesium	924	1270	50	4
P-6	TSS	750	2000	1000	500

The zinc concentrations from the duplicate samples from March 2013 were above the acceptable RPD (30%) at three of the six locations sampled; in particular, there was an order of magnitude difference in zinc concentrations at stations CL and LCM measured at the two labs. Additionally, the zinc concentration at sample CL analyzed by AGAT was above the PWQO (20 µg/L).

A blind duplicate sample collected at Station CL (Côté Lake) was submitted to Testmark. The zinc concentrations of the sample and the blind duplicate had a higher than acceptable RPD of 60% (with concentrations of 10.4 µg/L and 5.6 µg/L, respectively). All other parameters concentrations had an acceptable RPD (<30%).

Groundwater Quality Assurance/Quality Control

Blanks

The blanks that had parameter concentrations greater than the CWQG and PWQO are as follows:

- trip blank from June 13, 2012 had a dissolved aluminum concentration (13 µg/L) greater than the CWQG (5 µg/L);
- field blank from May 18, 2012 had a dissolved aluminum concentration (31 µg/L) greater than the CWQG (5 µg/L), and a dissolved zinc concentration (51 µg/L) greater than the PWQO (20 µg/L) and CWQG (30 µg/L);
- field blank from August 14, 2012 had a dissolved aluminum concentration (18 µg/L) greater than the CWQG (5 µg/L); and
- field blank from August 20, 2012 had a dissolved aluminum concentration (35 µg/L) greater than the CWQG (5 µg/L) and a dissolved zinc concentration (24 µg/L) greater than the PWQO (20 µg/L).



Blind Duplicate Samples

The analytical data for the blind duplicate samples (collected at the same time and in the same location as surface water samples) were reviewed. The results of this review (Table 3) indicated that the baseline monitoring program analytical data was generally of acceptable quality, with the exception of the following, which had a higher than acceptable difference (i.e. RPD >30%). It should be noted that it is not uncommon to have RPDs as high as 200% for results near the detection limit.

Table 3: Quality Assurance/Quality Control Blind Duplicate for Samples with Relative Percent Difference >30%

Sample Location	Sampling Date	Parameter (units)	Sample Concentration	Duplicate Concentration	Detection Limit
DH12-PO-14B	May 28, 2012	potassium (µg/L)	590	860	50
		sodium (µg/L)	8550	4980	50
		aluminum (µg/L)	94	25	4
		zinc (µg/L)	153	28	4
		ammonia (µg/L)	270	110	20
DH12-TMF-16	June 6, 2012	aluminum (µg/L)	184	25	4
		barium (µg/L)	6	3	2
		iron (µg/L)	20	<10	10
		manganese (µg/L)	17	4	2
		silver (µg/L)	0.2	<0.1	0.1
		strontium (µg/L)	34	21	5
		zinc (µg/L)	353	<5	5
DH12-TMF-32B	August 15, 2012	TSS (µg/L)	4,500,000	2,120,000	10,000
		aluminum (µg/L)	31	7	4
		copper (µg/L)	<2	3	2
		zinc (µg/L)	48	5	4
DH12-TMF-27A	November 29, 2012	silver (µg/L)	0.1	0.2	0.1
BH12-4	November 29, 2012	aluminum (µg/L)	31	17	4
		zinc (µg/L)	43	10	5
		TSS (µg/L)	189,000	283,000	1,000
		TDS (µg/L)	182,000	90,000	20,000
DH12-WD-25B	November 29, 2012	aluminum (µg/L)	82	20	4
		zinc (µg/L)	137	<5	5

Comparison of Total and Dissolved Metals

Laboratory analytical certificates of total and dissolved metal concentrations in groundwater samples collected in 2012 and were reviewed and the total and dissolved concentrations were compared. On occasion, the following dissolved parameter concentrations exceeded the total concentrations:



- Dissolved zinc was higher than the total concentration on at least one occasion at 16 wells (with the highest differences in concentrations being 864 µg/L vs. 36 µg/L and 153 µg/L vs. 32 µg/L at 2 wells in May 2012 and 69 µg/L vs. 5 µg/L at one well in August 2012). Dissolved zinc concentrations were higher than total zinc concentrations on one occasion in a trip blank (16 µg/L vs. <5 µg/L in June 2012), and on two occasions in a field blank sample (24 µg/L vs. <5 µg/L in August 2012 and 51 µg/L vs. <5 µg/L in May 2012).
- Dissolved tungsten was higher than the total concentration on at least one occasion at 14 wells (with the highest differences in concentrations being 232 µg/L vs. 23 µg/L and 212 µg/L vs. 46 µg/L at 2 wells in May 2012).
- Dissolved molybdenum was higher than the total concentration on at least one occasion at 9 wells (with the highest differences in concentrations being 127 µg/L vs. 99 µg/L and 33 µg/L vs. 2 µg/L at 2 wells in May 2012).
- Dissolved boron was higher than the total concentration on at least one occasion at 2 wells (with the highest difference being 219 µg/L vs. 139 µg/L in May 2012).
- Dissolved aluminum was higher than the total concentration on at least one occasion at 7 wells and on two occasions in a field blank. In the field blank from May 2012, the dissolved aluminum concentration was 31 µg/L while the total concentration was below the detection limit.
- Dissolved strontium was higher than the total concentration on at least one occasion at 5 wells (with the highest difference being 66 µg/L vs. 80 µg/L in May 2012).
- Dissolved manganese was higher than the total concentration on at least one occasion at 5 wells (with the highest difference being 408 µg/L vs. 485 µg/L in May 2012).
- Dissolved iron was higher than the total concentration on at least one occasion at 3 wells (with the highest difference being 12100 µg/L vs. 12200 µg/L in August 2012).

SUMMARY

Overall, the analytical data is of acceptable quality, however the review of the QA/QC analysis results indicated that there are some discrepancies for certain parameters, in particular zinc, the source for which is currently unknown. On several occasions, concentrations were notably different in the sample analysis versus the duplicate analysis. Furthermore, some blank samples have concentrations of aluminum, zinc and total phosphorous that are greater than the PWQO and/or CWQG criteria. Nonetheless, given the number of samples that have been submitted as part of the water quality baseline study, the percentage of individual parameters that have had anonymous results is very small; as such, based on this QA/QC analysis, the water quality data is considered to be appropriate for the purposes of the EA.

Parameter (1)	Unit	Method Detection Limit	Ontario Drinking Water Standards (2)		CCME Water Guidelines (4)	Provincial Water Quality Objective (5)	Surface Water Quality Sampling Program - Duplicate Samples																		P-3 - Inflow to Bagsverd Lake	
			MAC	IMAC			SL - Schist Lake Outflow																		19-Nov-12	19-Nov-12 (DUP)
							31-May-12	31-May-12 (DUP)	18-Jul-12	18-Jul-12 (DUP)	20-Aug-12	20-Aug-12 (DUP)	24-Sep-12	24-Sep-12 (DUP)	23-Oct-12	23-Oct-12 (DUP)	17-Dec-12	17-Dec-12 (DUP)	29-Jan-13	29-Jan-13 (DUP)	24-Feb-13	24-Feb-13 (DUP)	19-Mar-13	19-Mar-13 (DUP)		
FIELD PARAMETERS																										
pH	pH units	--	--	--	6.5-9	6.5-8.5	7.4	--	--	--	7.41	--	7.36	--	6.96	--	7.08	--	6.81	--	7.52	--	7.18	--	6.32	--
Temperature	degrees Celsius	--	--	--	--	--	15.3	--	--	--	19.8	--	9.8	--	3.2	--	0.9	--	0.7	--	1	--	0.7	--	2.7	--
Conductivity	µS/cm	--	--	--	--	--	46	--	--	--	54.8	--	42.8	--	35.2	--	35.2	--	38.9	--	42.1	--	40.1	--	23	--
Dissolved Oxygen	µg/L	--	--	--	--	--	7700	--	--	--	6520	--	8000	--	9740	--	1123	--	11940	--	9310	--	8520	--	907	--
GENERAL PARAMETERS																										
pH	pH units	--	--	--	6.5-9	6.5-8.5	6.82	6.89	6.74	6.77	6.68	7.05	6.68	6.88	6.81	6.92	6.66	6.67	6.54	6.6	6.67	6.54	6.6	6.52	6.31	6.86
Alkalinity	µg/L as CaCO3	<5000	--	--	--	--	24000	23000	24000	23000	27000	13000	23000	22000	22000	25000	24000	28000	21000	28000	16000	29000	28000	7000	6000	
Acidity	µg/L as CaCO3	<5000	--	--	--	--	--	--	--	--	--	--	--	--	--	--	--	--	--	--	--	--	--	--	--	
Electrical Conductivity (EC)	µS/cm	<2	--	--	--	--	57	57	59	59	60	43	58	58	59	61	58	72	61	73	52	76	76	37	40	
Total Dissolved Solids (TDS)	µg/L	<20000	--	--	--	--	56000	80000	48000	46000	52000	46000	62000	52000	50000	46000	52000	44000	44000	<20000	22000	26000	44000	50000	72000	
Total Suspended Solids (TSS)	µg/L	<1000, <10000	--	--	+5000-25000 (6)	--	<10000	<10000	<10000	<10000	<10000	<1000	2000	3000	4000	1000	<1000	13200	<1000	3000	<1000	<1000	1000	<1000	<1000	
Total Hardness	µg/L as CaCO3	<500	--	--	--	--	26700	26900	28700	28800	28900	20200	29400	31300	27400	27200	28800	29700	29800	25100	32200	24200	32700	32000	19200	
Dissolved Organic Carbon (DOC)	µg/L	<500	--	--	--	--	8900	9000	9500	10200	7500	8600	9400	9300	9800	10200	8400	8000	8500	14200	8200	13500	8500	8500	14600	
Total Organic Carbon (TOC)	µg/L	<500	--	--	--	--	--	--	--	--	--	--	--	--	--	--	--	--	--	--	--	--	--	--	--	
Chemical Oxygen Demand (COD)	µg/L	<5000	--	--	--	--	--	--	--	--	--	--	--	--	--	--	--	--	--	--	--	--	--	--	--	
MAJOR IONS																										
Calcium (Ca)	µg/L	<50	--	--	--	--	8580	8660	9230	9270	9250	9250	9430	10000	8730	8670	9100	9440	9460	7180	10400	7460	10500	10300	6360	
Magnesium (Mg)	µg/L	<50	--	--	--	--	1280	1280	1370	1370	1410	1400	1430	1530	1360	1350	1430	1480	1490	1750	1520	1350	1580	1530	810	
Potassium (K)	µg/L	<50	--	--	--	--	260	280	340	330	310	300	270	290	270	310	290	310	270	310	360	470	390	330	320	
Sodium (Na)	µg/L	<50	--	--	--	--	710	690	720	730	730	720	730	760	730	710	770	740	730	1170	780	1110	760	750	1040	
Chloride (Cl)	µg/L	<100	--	--	--	--	370	340	380	320	380	350	410	380	370	320	370	380	380	740	340	910	340	360	400	
Fluoride (F)	µg/L	<50, <50000	1500(7)	--	--	--	<50	<50	<50	<50	<50	<50	<50	<50	<50	<50	<50	<50	<50	<50	<50	<50	<50	<50	<50	
Sulphate (SO4)	µg/L	<100	--	--	--	--	2960	2950	2810	2870	2970	3010	2590	2580	3320	3370	3500	3540	3190	3950	3030	3510	2920	2830	4920	
METALS																										
Aluminum (Al)	µg/L	<4	--	--	100(8)	75(9)	14	14	9	9	5	5	9	10	19	21	12	15	28	96	30	58	25	19	106	
Antimony (Sb)	µg/L	<6	--	6	--	20	<6	<6	<6	<6	<6	<6	<6	<6	<6	<6	<6	<6	<6	<6	<6	<6	<6	<6	<6	
Arsenic (As)	µg/L	<3	--	25	5	5	<3	<3	<3	<3	<3	<3	<3	<3	<3	<3	<3	<3	<3	<3	<3	<3	<3	<3	<3	
Barium (Ba)	µg/L	<2	1000	--	--	--	5	4	5	6	5	5	7	7	6	6	6	6	5	8	8	10	11	4	4	
Beryllium (Be)	µg/L	<1	--	--	--	11(10)	<1	<1	<1	<1	<1	<1	<1	<1	<1	<1	<1	<1	<1	<1	<1	<1	<1	<1	<1	
Boron (B)	µg/L	<10	--	5000	1500(11)	200	<10	<10	<10	<10	<10	<10	<10	<10	<10	<10	<10	<10	<10	<10	<10	<10	<10	<10	<10	
Cadmium (Cd)	µg/L	<0.1	--	5	0.058(12)	0.1(13)	<0.1	<0.1	<0.1	<0.1	<0.1	<0.1	<0.1	<0.1	<0.1	<0.1	<0.1	<0.1	<0.1	<0.1	<0.1	<0.1	<0.1	<0.1	<0.1	
Chromium (Cr)	µg/L	<3	50	--	8.9(14)	8.9(14)	<3	<3	<3	<3	<3	<3	<3	<3	<3	<3	<3	<3	<3	<3	<3	<3	<3	<3	<3	
Cobalt (Co)	µg/L	<0.5	--	--	--	0.9	<0.5	<0.5	<0.5	<0.5	<0.5	<0.5	<0.5	<0.5	<0.5	<0.5	<0.5	<0.5	<0.5	<0.5	<0.5	<0.5	<0.5	<0.5	<0.5	
Copper (Cu)	µg/L	<2	--	--	2(15)	5(16)	<2	<2	<2	<2	<2	<2	<2	<2	<2	<2	<2	<2	<2	4	<2	<2	<2	<2	<2	
Iron (Fe)	µg/L	<10	--	--	300	300	14	<10	34	50	44	45	33	29	66	60	24	23	41	176	95	104	77	62	153	
Lead (Pb)	µg/L	<1	10(17)	--	1(18)	3(19)	<1	<1	<1	<1	<1	<1	<1	<1	<1	<1	<1	<1	<1	<1	<1	<1	<1	<1	<1	
Manganese (Mn)	µg/L	<2	--	--	--	29	26	33	45	16	16	17	17	13	13	6	6	23	10	39	8	56	46	4	4	
Mercury (Hg)	µg/L	<0.10	1	--	0.026	0.2	<0.10	<0.10	<0.10	--	<0.10	<0.10	<0.10	<0.10	<0.10	<0.10	<0.10	<0.10	<0.10	<0.10	<0.10	<0.10	<0.10	<0.10	<0.10	
Molybdenum (Mo)	µg/L	<2	--	--	73	40	<2	<2	<2	<2	<2	<2	<2	<2	<2	<2	<2	<2	<2	<2	<2	<2	<2	<2	<2	
Nickel (Ni)	µg/L	<3	--	--	25(20)	25	<3	<3	<3	<3	<3	<3	<3	<3	<3	<3	<3	<3	<3	<3	<3	<3	<3	<3	<3	
Selenium (Se)	µg/L	<4	10	--	1	100	<4	<4	<4	<4	<4	<4	<4	<4	<4	<4	<4	<4	<4	<4	<4	<4	<4	<4	<4	
Silver (Ag)	µg/L	<0.1	--	--	0.1	0.1	<0.1	<0.1	<0.1	<0.1	<0.1	<0.1	<0.1	<0.1	<0.1	<0.1	<0.1	<0.1	<0.1	<0.1	<0.1	<0.1	<0.1	<0.1	<0.1	
Strontium (Sr)	µg/L	<5	--	--	--	24	20	23	27	24	25	27	27	21	21	21	21	22	25	20	24	13	30	30	13	
Thallium (Tl)	µg/L	<0.3	--	--	0.8	0.3	<0.3	<0.3	<0.3	<0.3	<0.3	<0.3	<0.3	<0.3	<0.3	<0.3	<0.3	<0.3	<0.3	<0.3	<0.3	<0.3	<0.3	<0.3	<0.3	
Titanium (Ti)	µg/L	<2	--	--	--	<2	<2	<2	<2	<2	<2	<2	<2	<2	<2	<2	<2	<2	<2	<2	<2	<2	<2	<2	<2	
Tungsten (W)	µg/L	<10	--	--	--	30	<10	<10	<10	<10	<10	<10	<10	<10	<10	<10	<10	<10	<10	<10	<10	<10	<10	<10	<10	
Uranium (U)	µg/L	<2	20	--	15	5	<2	<2	<2	<2	<2	<2	<2	<2	<2	<2	<2	<2	<2	<2	<2	<2	<2	<2	<2	
Vanadium (V)	µg/L	<2	--	--	--	6	<2	<2	<2	<2	<2	<2	<2	<2	<2	<2	<2	<2	<2	<2	<2	<2	<2	<2	<2	
Zinc (Zn)	µg/L	<5	--	--	30	20	61	<5	<5	65	<5	<5	7	<5	<5	<5	<5	<5	<5	8	7	6	<5	<5	<5	
Zirconium (Zr)	µg/L	<4	--	--	--	4	<4	<4	<4	<4	<4	<4	<4	<4	<4	<4	<4	<4	<4	<4	<4	<4	<4	<4	<4	
OTHER PARAMETERS																										
Total Cyanide	µg/L	<2	--	--	--	--	4	<2	<2	<2	<2	<2	<2	<2	<2	<2	<2	<2	<2	<2	<2	<2	<2	<2	<2	
Sulphur (S)	µg/L	<50	--	--	--	--	--	--	--	--	--	--	--	--	--	--	--	--	--	--	--	--	--	--	--	
NUTRIENTS																										
Nitrate (NO3																										

APPENDIX D
Quality Assurance/Quality Control Sample Results

Parameter ⁽¹⁾	Unit	Method Detection Limit	Ontario Drinking Water Standards ⁽²⁾⁽³⁾		CCME Water Guidelines ⁽⁴⁾	Provincial Water Quality Objective ⁽⁵⁾	Surface Water Quality Sampling Program - Blanks															
			MAC	IMAC			CH2-BLK					CH2-BLK1					CH2-BLK2					
							28-Nov-11	22-Dec-11	24-Jan-12	21-Feb-12	26-Mar-12	18-Jul-12	19-Nov-12	29-Jan-13	25-Jun-12	20-Aug-12	24-Sep-12	17-Dec-12	24-Feb-13	19-Mar-13	25-Jun-12	24-Feb-13
FIELD PARAMETERS																						
pH	pH units	--	--	--	6.5-9	6.5-8.5	--	--	--	--	--	--	--	--	--	--	--	--	--	--	--	--
Temperature	degrees Celsius	--	--	--	--	--	--	--	--	--	--	--	--	--	--	--	--	--	--	--	--	--
Conductivity	µS/cm	--	--	--	--	--	--	--	--	--	--	--	--	--	--	--	--	--	--	--	--	--
Dissolved Oxygen	µg/L	--	--	--	--	--	--	--	--	--	--	--	--	--	--	--	--	--	--	--	--	--
GENERAL PARAMETERS																						
pH	pH units	--	--	--	6.5-9	6.5-8.5	5.72	5.61	5.63	5.89	6.37	5.32	5.55	6.35	6.27	6.08	6.13	6.7	5.88	5.74	6.09	5.62
Alkalinity	µg/L as CaCO3	<5000	--	--	--	-25%	<5000	<5000	<5000	<5000	<5000	<5000	<5000	<5000	<5000	<5000	<5000	<5000	<5000	<5000	<5000	<5000
Acidity	µg/L as CaCO3	<5000	--	--	--	--	--	--	--	--	--	--	--	--	--	--	--	--	--	--	--	--
Electrical Conductivity (EC)	µS/cm	<2	--	--	--	--	<2	<2	<2	3	<2	<2	6	3	3	4	7	<2	<2	3	<2	<2
Total Dissolved Solids (TDS)	µg/L	<20000	--	--	--	--	<20000	<20000	<20000	46000	<20000	<20000	<20000	<20000	<20000	<20000	<20000	<20000	<20000	<20000	<20000	<20000
Total Suspended Solids (TSS)	µg/L	<1000, <10000	--	--	+5000-25000 ⁽⁶⁾	--	<10000	<10000	<10000	<10000	<10000	<10000	<10000	<10000	<10000	<10000	<10000	<10000	<10000	<10000	<10000	<10000
Total Hardness	µg/L as CaCO3	<500	--	--	--	--	<500	<500	<500	599	<500	599	974	<500	549	699	1830	<500	<500	<500	700	800
Dissolved Organic Carbon (DOC)	µg/L	<500	--	--	--	--	<500	800	<500	500	800	500	500	900	700	<500	500	<500	<500	700	800	<500
Total Organic Carbon (TOC)	µg/L	<500	--	--	--	--	--	--	--	--	--	--	--	--	--	--	--	--	--	--	--	--
Chemical Oxygen Demand (COD)	µg/L	<5000	--	--	--	--	--	--	--	--	--	--	--	--	--	--	--	--	--	--	--	--
MAJOR IONS																						
Calcium (Ca)	µg/L	<50	--	--	--	--	90	110	70	80	240	<50	90	390	170	220	280	600	80	80	150	80
Magnesium (Mg)	µg/L	<50	--	--	--	--	<50	<50	<50	<50	<50	<50	<50	<50	<50	<50	80	<50	<50	<50	<50	<50
Potassium (K)	µg/L	<50	--	--	--	--	<50	<50	<50	60	50	100	<50	<50	<50	<50	<50	<50	<50	<50	<50	<50
Sodium (Na)	µg/L	<50	--	--	--	--	240	290	230	210	540	50	350	830	390	430	570	1080	270	240	360	250
Chloride (Cl)	µg/L	<100	--	--	--	--	<100	<100	<100	<100	<100	<100	<100	<100	<100	<100	<100	<100	<100	<100	<100	<100
Fluoride (F)	µg/L	<50, <50000	1500 ⁽⁷⁾	--	--	--	<50	<50	<50	<50	<50	<50	<50	<50	<50000	<50	<50	<50	<50	<50	<50000	<50
Sulphate (SO4)	µg/L	<100	--	--	--	--	<100	<100	<100	<100	<100	<100	<100	<100	<100	<100	<100	<100	<100	<100	<100	<100
METALS																						
Aluminum (Al)	µg/L	<4	--	--	100 ⁽⁸⁾	75 ⁽⁹⁾	6	6	4	<4	<4	<4	<4	18	16	28	34	44	13	20	12	11
Antimony (Sb)	µg/L	<6	--	6	--	--	<6	<6	<6	<6	<6	<6	<6	<6	<6	<6	<6	<6	<6	<6	<6	<6
Arsenic (As)	µg/L	<3	--	25	5	5	<3	<3	<3	<3	<3	<3	<3	<3	<3	<3	<3	<3	<3	<3	<3	<3
Barium (Ba)	µg/L	<2	1000	--	--	--	<2	<2	<2	<2	<2	<2	<2	<2	<2	2	2	<2	<2	<2	<2	<2
Beryllium (Be)	µg/L	<1	--	--	--	11 ⁽¹⁰⁾	<1	<1	<1	<1	<1	<1	<1	<1	<1	<1	<1	<1	<1	<1	<1	<1
Boron (B)	µg/L	<10	--	5000	1500 ⁽¹¹⁾	200	<10	<10	<10	<10	<10	<10	<10	<10	<10	<10	<10	<10	<10	<10	<10	<10
Cadmium (Cd)	µg/L	<0.1	--	5	0.058 ⁽¹²⁾	0.1 ⁽¹³⁾	<0.1	<0.1	<0.1	<0.1	<0.1	<0.1	<0.1	<0.1	<0.1	<0.1	<0.1	<0.1	<0.1	<0.1	<0.1	<0.1
Chromium (Cr)	µg/L	<3	50	--	8.9 ⁽¹⁴⁾	8.9 ⁽¹⁴⁾	<3	<3	<3	<3	<3	<3	<3	<3	<3	<3	<3	<3	<3	<3	<3	<3
Cobalt (Co)	µg/L	<0.5	--	--	--	0.9	<0.5	<0.5	<0.5	<0.5	<0.5	<0.5	<0.5	<0.5	<0.5	<0.5	<0.5	<0.5	<0.5	<0.5	<0.5	<0.5
Copper (Cu)	µg/L	<2	--	--	2 ⁽¹⁵⁾	5 ⁽¹⁶⁾	<2	<2	<2	<2	<2	<2	<2	<2	<2	<2	<2	<2	<2	<2	<2	<2
Iron (Fe)	µg/L	<10	--	--	300	300	<10	<10	<10	<10	<10	<10	<10	<10	<10	<10	<10	<10	<10	<10	<10	<10
Lead (Pb)	µg/L	<1	10 ⁽¹⁷⁾	--	1 ⁽¹⁸⁾	3 ⁽¹⁹⁾	<1	<1	<1	<1	<1	<1	<1	<1	<1	<1	<1	<1	<1	<1	<1	<1
Manganese (Mn)	µg/L	<2	--	--	--	--	<2	<2	<2	<2	<2	<2	<2	<2	<2	<2	2	<2	<2	<2	<2	<2
Mercury (Hg)	µg/L	<0.10	1	--	0.026	0.2	<0.10	<0.10	<0.10	<0.10	<0.10	<0.10	<0.10	<0.10	<0.10	--	<0.10	<0.10	<0.10	<0.10	<0.10	<0.10
Molybdenum (Mo)	µg/L	<2	--	--	73	40	<2	<2	<2	<2	<2	<2	<2	<2	<2	<2	<2	<2	<2	<2	<2	<2
Nickel (Ni)	µg/L	<3	--	--	25 ⁽²⁰⁾	25	<3	<3	<3	<3	<3	<3	<3	<3	<3	<3	<3	<3	<3	18	<3	<3
Selenium (Se)	µg/L	<4	10	--	1	100	<4	<4	<4	<4	<4	<4	<4	<4	<4	<4	<4	<4	<4	<4	<4	<4
Silver (Ag)	µg/L	<0.1	--	--	0.1	0.1	<0.1	<0.1	<0.1	<0.1	<0.1	<0.1	<0.1	<0.1	<0.1	<0.1	<0.1	<0.1	<0.1	<0.1	<0.1	<0.1
Strontium (Sr)	µg/L	<5	--	--	--	--	<5	<5	<5	<5	<5	<5	<5	<5	<5	<5	<5	<5	<5	<5	<5	<5
Thallium (Tl)	µg/L	<0.3	--	--	0.8	0.3	<0.3	<0.3	<0.3	<0.3	<0.3	<0.3	<0.3	<0.3	<0.3	<0.3	<0.3	<0.3	<0.3	<0.3	<0.3	<0.3
Titanium (Ti)	µg/L	<2	--	--	--	--	<2	<2	<2	<2	<2	<2	<2	<2	<2	<2	<2	<2	<2	<2	<2	<2
Tungsten (W)	µg/L	<10	--	--	--	30	<10	<10	<10	<10	<10	<10	<10	<10	<10	<10	<10	<10	<10	<10	<10	<10
Uranium (U)	µg/L	<2	20	--	15	5	<2	<2	<2	<2	<2	<2	<2	<2	<2	<2	<2	<2	<2	<2	<2	<2
Vanadium (V)	µg/L	<2	--	--	--	6	<2	<2	<2	<2	<2	<2	<2	<2	<2	<2	<2	<2	<2	<2	<2	<2
Zinc (Zn)	µg/L	<5	--	--	30	20	<5	<5	26	8	<5	<5	<5	6	<5	<5	45	<5	<5	<5	<5	<5
Zirconium (Zr)	µg/L	<4	--	--	--	4	<4	<4	<4	<4	<4	<4	<4	<4	<4	<4	<4	<4	<4	<4	<4	<4
OTHER PARAMETERS																						
Total Cyanide	µg/L	<2	--	--	--	--	<2	<2	<2	<2	<2	<2	<2	<2	<2	<2	<2	<2	<2	<2	<2	<2
Sulphur (S)	µg/L	<50	--	--	--	--	--	--	--	--	--	--	--	--	--	--	--	--	--	--	--	--
NUTRIENTS																						
Nitrate (NO3-)	µg/L as N	<50	10000	--	13000 ⁽²¹⁾	--	--	--	--	--	--	--	--	--	--	--	--	--	--	--	--	--
Nitrite (NO2-)	µg/L as N	<50	1000	--	60 ⁽²²⁾	--	--	--	--	--	--	--	--	--	--	--	--	--	--	--	--	--
Total Ammonia (NH3)	µg/L as N	<20	--	--	6980	--	<20	<20	<20	<20	<20	<20	<20	<20	<20	<20	<20	<20	<20	<20	<20	<20
Un-ionized Ammonia (NH3) ⁽²³⁾	µg/L	--	--	--	19 ⁽²³⁾	20 ⁽²³⁾	--	--	--	--	--	--	--	--	--	--	--	--	--	--	--	--
Total Kjeldahl Nitrogen	µg/L	<100	--	--	--	--	--	--	--	--	--	--	--	--	--	--	--	--	--	--	--	--
Total Phosphorus (TP)	µg/L	<20	--	--	20	20	<20	<20	<20	<20	<20	<20	<20	<20	<20	30	20	<20	<20	<20	<20	<20
Phosphate (PO4)	µg/L as P	<100	--	--	--	--	--	--	--	--	--	--	--	--	--	--	--	<100	--	--	--	

APPENDIX D
Quality Assurance/Quality Control Sample Results

Parameter	Unit	Method Detection Limit	Ontario Drinking Water Standards ⁽¹⁾⁽²⁾		Canadian Water Quality Guidelines ⁽⁴⁾	Provincial Water Quality Objective ⁽⁵⁾	Groundwater Quality Sampling Program - Duplicate Samples									
			MAC	IMAC			DH12-PO-14B - Open Pit Footprint		DH12-TMF-16 - TMF Footprint and Adjacent Areas		DH12-TMF-27A - TMF Footprint and Adjacent Areas		BH12-4 - Open Pit Footprint		DH12-WD-25B - North of Open Pit	
							28-May-12	28-May-12 (DUP)	6-Jun-12	6-Jun-12 (DUP)	29-Nov-12	29-Nov-12 (DUP)	29-Nov-12	29-Nov-12 (DUP)	29-Nov-12	29-Nov-12 (DUP)
FIELD PARAMETERS																
pH	pH units	--	--	--	6.5-9	6.5-8.5	7.93	--	8.16	--	7	--	7.9	--	7.3	--
Conductivity	µs/cm	--	--	--	--	--	192	--	126	--	80	--	130	--	266	--
Temperature	degrees Celsius	--	--	--	--	--	8.2	--	10	--	--	--	6.5	--	5	--
GENERAL PARAMETERS																
pH	pH units	--	--	--	6.5-9	6.5-8.5	7.83	7.87	7.58	7.6	7.43	7.26	7.57	7.65	7.68	7.68
Alkalinity	µg/L as CaCO ₃	<5000	--	--	--	-25% ⁽⁶⁾	91000	97000	64000	67000	43000	43000	60000	59000	139000	132000
Acidity	µg/L as CaCO ₃	<5000	--	--	--	--	<5000	<5000	<5000	<5000	<5000	<5000	<5000	<5000	<5000	<5000
Electrical Conductivity (EC)	µS/cm	<2	--	--	--	--	189	200	136	142	101	96	141	137	267	253
Total Suspended Solids (TSS)	µg/L	<10000	--	--	+5000-25000 ⁽⁶⁾	--	16000000	12300000	12500000	12600000	5980000	7720000	1890000	2830000	7550000	5770000
Total Dissolved Solids (TDS)	µg/L	<20000	--	--	--	--	184000	164000	86000	88000	74000	64000	182000	90000	164000	178000
Total Hardness	µg/L as CaCO ₃	<500	--	--	--	--	81300	92500	62800	65800	46200	42600	63600	61700	130000	128000
MAJOR IONS																
Calcium (Ca)	µg/L	<50	--	--	--	--	24800	28100	17400	18400	11000	10200	21200	20600	43500	42800
Chloride (Cl)	µg/L	<100	--	--	--	--	2440	2590	420	410	600	500	1280	1290	960	810
Sodium (Na)	µg/L	<50	--	--	--	--	8550	4980	2040	2460	2250	2080	1840	1820	5100	4790
Fluoride (F)	µg/L	<50, <100, <50000	1500 ⁽⁷⁾	--	--	--	140	140	70	70	70	70	<50	<50	<50	<50
Magnesium (Mg)	µg/L	<50	--	--	--	--	4710	5430	4690	4830	4540	4160	2590	2480	5170	5010
Potassium (K)	µg/L	<50	--	--	--	--	590	860	430	450	470	410	520	550	620	590
Sulphate (SO ₄)	µg/L	<100	--	--	--	--	8270	8400	5910	6060	6840	5530	8580	8390	1630	1570
METALS ⁽¹⁰⁾																
Aluminum (Al)	µg/L	<4	--	--	100 ⁽⁸⁾	75 ⁽⁹⁾	94	25	184	25	48	52	31	17	82	20
Antimony (Sb)	µg/L	<6	--	6	--	20	<6	<6	<6	<6	<6	<6	<6	<6	<6	<6
Arsenic (As)	µg/L	<3	--	25	5	5	<3	<3	<3	<3	<3	<3	<3	<3	5	4
Barium (Ba)	µg/L	<2	1000	--	--	--	15	15	6	3	6	6	11	11	27	23
Beryllium (Be)	µg/L	<1	--	--	--	11 ⁽¹⁰⁾	<1	<1	<1	<1	<1	<1	<1	<1	<1	<1
Boron (B)	µg/L	<10	--	5000	1500 ⁽¹¹⁾	200	<10	<10	<10	<10	<10	<10	<10	<10	<10	<10
Cadmium (Cd)	µg/L	<0.1	--	5	0.058 ⁽¹²⁾	0.1 ⁽¹³⁾	<0.1	<0.1	<0.1	<0.1	<0.1	<0.1	<0.1	<0.1	<0.1	<0.1
Chromium (Cr)	µg/L	<3	50	--	8.9 ⁽¹⁴⁾	8.9 ⁽¹⁴⁾	<3	<3	<3	<3	<3	<3	<3	<3	<3	<3
Cobalt (Co)	µg/L	<0.5	--	--	--	0.9	<0.5	<0.5	<0.5	<0.5	<0.5	<0.5	<0.5	<0.5	<0.5	<0.5
Copper (Cu)	µg/L	<2	--	--	2 ⁽¹⁵⁾	5 ⁽¹⁶⁾	<2	<2	6	6	4	3	2	2	<2	<2
Iron (Fe)	µg/L	<10	--	--	300	300	32	31	20	<10	13	15	<10	<10	4130	4540
Lead (Pb)	µg/L	<1	10 ⁽¹⁷⁾	--	1 ⁽¹⁸⁾	3 ⁽¹⁹⁾	<1	<1	<1	<1	<1	<1	<1	<1	<1	<1
Manganese (Mn)	µg/L	<2	--	--	--	--	56	53	17	4	33	31	29	25	462	431
Mercury (Hg)	µg/L	<0.10	1	--	0.026	0.2	<0.1	<0.1	<0.10	<0.10	<0.1	<0.1	<0.1	<0.1	<0.1	<0.1
Molybdenum (Mo)	µg/L	<2	--	--	73	40	10	10	<2	<2	<2	<2	<2	<2	<2	<2
Nickel (Ni)	µg/L	<3	--	--	25 ⁽²⁰⁾	25	<3	<3	<3	<3	<3	<3	<3	<3	<3	<3
Selenium (Se)	µg/L	<4	10	--	1	100	<4	<4	<4	<4	<4	<4	<4	<4	<4	<4
Silver (Ag)	µg/L	<0.1	--	--	0.1	0.1	<0.1	<0.1	0.2	<0.1	0.1	0.2	<0.1	<0.1	<0.1	<0.1
Strontium (Sr)	µg/L	<5	--	--	--	--	69	65	34	21	28	27	33	32	81	74
Thallium (Tl)	µg/L	<0.3, <4	--	--	0.8	0.3	<0.3	<0.3	<0.3	<0.3	<0.3	<0.3	<0.3	<0.3	<0.3	<0.3
Titanium (Ti)	µg/L	<0.1, <2	--	--	--	--	<2	<2	<2	<2	<2	3	<2	<2	<2	<2
Tungsten (W)	µg/L	<0.1, <10	--	--	--	30	92	94	74	75	13	13	23	23	<10	<10
Uranium (U)	µg/L	<2, <4	20	--	15	5	<2	<2	<2	<2	<2	<2	9	8	<2	<2
Vanadium (V)	µg/L	<0.1, <2	--	--	--	6	<2	<2	2	<2	<2	<2	<2	<2	<2	<2
Zinc (Zn)	µg/L	<4, <5	--	--	30	20	153	28	353	<5	<5	<5	43	10	137	<5
Zirconium (Zr)	µg/L	<0.1, <4	--	--	--	4	<4	<4	<4	<4	<4	<4	<4	<4	<4	<4
NUTRIENTS																
Nitrate (NO ₃ ⁻)	µg/L as N	<50	10000	--	13000 ⁽²¹⁾	--	<50	<50	410	360	<50	<50	120	120	<50	<50
Nitrite (NO ₂ ⁻)	µg/L as N	--	1000	--	60 ⁽²²⁾	--	<50	<50	<50	<50	<50	<50	<50	<50	<50	<50
Ammonia (NH ₃)	µg/L as N	<20	--	--	6980	--	270	110	<20	<20	30	30	<20	<20	0.2	0.2
Un-Ionized Ammonia	µg/L as N	<20	--	--	19 ⁽²³⁾	20 ⁽²³⁾	<20	<20	<20	<20	<20	<20	<20	<20	<20	<20
NUTRIENTS																
Free Cyanide	µg/L	<2	200	--	5	5	<2	<2	<2	<2	<2	<2	<2	<2	<2	<2
Sulphur (S)	µg/L	<50	--	--	--	--	--	--	2040	2080	--	--	2650	2560	640	620

APPENDIX D
Quality Assurance/Quality Control Sample Results

Parameter	Unit	Method Detection Limit	Ontario Drinking Water Standards ⁽¹⁾⁽²⁾		Canadian Water Quality Guidelines ⁽⁴⁾	Provincial Water Quality Objective ⁽⁵⁾	Groundwater Quality Sampling Program - Blanks					
			MAC	IMAC			TRIP BLANK			FIELD BLANK	GW BLK-1	GW BLK-2
							18-May-12	13-Jun-12	20-Aug-12	18-May-12	14-Aug-12	20-Aug-12
FIELD PARAMETERS												
pH	pH units	--	--	--	6.5-9	6.5-8.5	--	--	--	--	--	--
Conductivity	µs/cm	--	--	--	--	--	--	--	--	--	--	--
Temperature	degrees Celsius	--	--	--	--	--	--	--	--	--	--	--
GENERAL PARAMETERS												
pH	pH units	--	--	--	6.5-9	6.5-8.5	6.28	6.33	5.66	6.05	6.22	6.33
Alkalinity	µg/L as CaCO ₃	<5000	--	--	--	-25% ⁽⁵⁾	<5000	<5000	<5000	<5000	<5000	<5000
Acidity	µg/L as CaCO ₃	<5000	--	--	--	--	<5000	<5000	<5000	<5000	<5000	<5000
Electrical Conductivity (EC)	µS/cm	<2	--	--	--	--	<2	2	<2	<2	2	3
Total Suspended Solids (TSS)	µg/L	<10000	--	--	+5000-25000 ⁽⁶⁾	--	<10000	<10000	<10000	<10000	<10000	<10000
Total Dissolved Solids (TDS)	µg/L	<20000	--	--	--	--	<20000	<20000	<20000	<20000	<20000	<20000
Total Hardness	µg/L as CaCO ₃	<500	--	--	--	--	<500	<500	<500	<500	<500	<500
MAJOR IONS												
Calcium (Ca)	µg/L	<50	--	--	--	--	60	150	<50	100	180	162
Chloride (Cl)	µg/L	<100	--	--	--	--	<100	<100	130	<100	<100	<100
Sodium (Na)	µg/L	<50	--	--	--	--	180	340	<50	290	330	342
Fluoride (F)	µg/L	<50, <100, <50000	1500 ⁽⁷⁾	--	--	--	<50	<50	<50000	<50	<50	<50000
Magnesium (Mg)	µg/L	<50	--	--	--	--	<50	<50	<50	<50	<50	<50
Potassium (K)	µg/L	<50	--	--	--	--	<50	<50	<50	<50	<50	<50
Sulphate (SO ₄)	µg/L	<100	--	--	--	--	<100	<100	<100	<100	<100	<100
METALS ⁽¹⁰⁾												
Aluminum (Al)	µg/L	<4	--	--	100 ⁽⁸⁾	75 ⁽⁹⁾	<4	13	<4	31	18	35
Antimony (Sb)	µg/L	<6	--	6	--	20	<6	<6	<6	<6	<6	<6
Arsenic (As)	µg/L	<3	--	25	5	5	<3	<3	<3	<3	<3	<3
Barium (Ba)	µg/L	<2	1000	--	--	--	<2	<2	<2	<2	<2	<2
Beryllium (Be)	µg/L	<1	--	--	--	11 ⁽¹⁰⁾	<1	<1	<1	<1	<1	<1
Boron (B)	µg/L	<10	--	5000	1500 ⁽¹¹⁾	200	<10	<10	<10	<10	<10	<10
Cadmium (Cd)	µg/L	<0.1	--	5	0.058 ⁽¹²⁾	0.1 ⁽¹³⁾	<0.1	<0.1	<0.1	<0.1	<0.1	<0.1
Chromium (Cr)	µg/L	<3	50	--	8.9 ⁽¹⁴⁾	8.9 ⁽¹⁴⁾	<3	<3	<3	<3	<3	<3
Cobalt (Co)	µg/L	<0.5	--	--	--	0.9	<0.5	<0.5	<0.5	<0.5	<0.5	<0.5
Copper (Cu)	µg/L	<2	--	--	2 ⁽¹⁵⁾	5 ⁽¹⁶⁾	<2	<2	<2	<2	<2	<2
Iron (Fe)	µg/L	<10	--	--	300	300	<10	<10	<10	<10	<10	<10
Lead (Pb)	µg/L	<1	10 ⁽¹⁷⁾	--	1 ⁽¹⁸⁾	3 ⁽¹⁹⁾	<1	<1	<1	<1	<1	<1
Manganese (Mn)	µg/L	<2	--	--	--	--	<2	<2	<2	3	<2	<2
Mercury (Hg)	µg/L	<0.10	1	--	0.026	0.2	<0.1	<0.1	<0.1	<0.1	<0.1	<0.1
Molybdenum (Mo)	µg/L	<2	--	--	73	40	<2	<2	<2	<2	<2	<2
Nickel (Ni)	µg/L	<3	--	--	25 ⁽²⁰⁾	25	<3	<3	<3	<3	<3	<3
Selenium (Se)	µg/L	<4	10	--	1	100	<4	<4	<4	<4	<4	<4
Silver (Ag)	µg/L	<0.1	--	--	0.1	0.1	<0.1	<0.1	<0.1	<0.1	<0.1	<0.1
Strontium (Sr)	µg/L	<5	--	--	--	--	<5	<5	<5	<5	<5	<5
Thallium (Tl)	µg/L	<0.3, <4	--	--	0.8	0.3	<0.3	<0.3	<0.3	<0.3	<0.3	<0.3
Titanium (Ti)	µg/L	<0.1, <2	--	--	--	--	<2	<2	<2	<2	<2	<2
Tungsten (W)	µg/L	<0.1, <10	--	--	--	30	<10	<10	<10	<10	<10	<10
Uranium (U)	µg/L	<2, <4	20	--	15	5	<2	<2	<2	<2	<2	<2
Vanadium (V)	µg/L	<0.1, <2	--	--	--	6	<2	<2	<2	<2	<2	<2
Zinc (Zn)	µg/L	<4, <5	--	--	30	20	<5	16	<5	51	<5	24
Zirconium (Zr)	µg/L	<0.1, <4	--	--	--	4	<4	<4	<4	<4	<4	<4
NUTRIENTS												
Nitrate (NO ₃ ⁻)	µg/L as N	<50	10000	--	13000 ⁽²¹⁾	--	<50	<50	<50	<50	--	<50
Nitrite (NO ₂ ⁻)	µg/L as N		1000	--	60 ⁽²²⁾	--	<50	<50	<50	<50	--	<50
Ammonia (NH ₃)	µg/L as N	<20	--	--	6980	--	<20	<20	--	<20	<20	<20
Un-Ionized Ammonia	µg/L as N	<20	--	--	19 ⁽²³⁾	20 ⁽²³⁾	<20	--	--	<20	<20	<20
NUTRIENTS												
Free Cyanide	µg/L	<2	200	--	5	5	<2	<2	<2	--	<2	<2
Sulphur (S)	µg/L	<50	--	--	--	--	--	--	--	--	--	--

Parameter ⁽¹⁾	Unit	Method Detection Limit	Ontario Drinking Water Standards ⁽²⁾⁽³⁾		Canadian Water Quality Guidelines ⁽⁴⁾	Provincial Water Quality Objective ⁽⁵⁾	Water Column Profile Surface Water Sampling Program - Duplicates				Blanks	
							BAG-LS1		MESO-LS2		Field Blank	Trip Blank
			MAC	IMAC			21-May-2013 (T)	21-May-2013 (T Dup)	28-May-2013 (T)	28-May-2013 (T Dup)	28-May-13	28-May-13
FIELD PARAMETERS												
pH	pH units	--	--	--	6.5-9	6.5-8.5	7.14	7.14	7.04	7.04	--	--
Temperature	degrees Celsius	--	--	--	--	-0.25	11.4	11.4	9.77	9.77	--	--
Conductivity	µS/cm	--	--	--	--	--	50	50	50	50	--	--
Dissolved Oxygen	µg/L	--	--	--	--	--	--	--	10870	10870	--	--
ORP	mV	--	--	--	--	--	204.3	204.3	113.8	113.8	--	--
GENERAL PARAMETERS												
pH	pH units	--	--	--	6.5-9	6.5-8.5	6.49	6.43	6.36	6.35	5.13	5.01
Alkalinity	µg/L as CaCO ₃	<5000	--	--	--	-25%	19000	19000	18000	20000	<5000	<5000
Acidity	µg/L as CaCO ₃	<5000	--	--	--	--	<5000	<5000	<5000	<5000	<5000	<5000
Electrical Conductivity (EC)	µS/cm	<2	--	--	--	--	55	55	56	56	2	<2
Total Dissolved Solids (TDS)	µg/L	<20000	--	--	--	--	52000	56000	56000	84000	<20000	<20000
Total Suspended Solids (TSS)	µg/L	<1000, <10000	--	--	+5000-25000 ⁽⁶⁾	--	<10000	<10000	<10000	<10000	<10000	<10000
Total Hardness	µg/L as CaCO ₃	<500	--	--	--	--	26100	26000	25600	24700	<500	<500
Dissolved Organic Carbon (DOC)	µg/L	<500	--	--	--	--	8900	8900	7900	7800	<500	<500
Total Organic Carbon (TOC)	µg/L	<500	--	--	--	--	9500	9300	8500	8500	<500	<500
Chemical Oxygen Demand (COD)	µg/L	<5000	--	--	--	--	--	--	--	--	--	--
MAJOR IONS												
Calcium (Ca)	µg/L	<50	--	--	--	--	8390	8320	7530	7300	90	<50
Magnesium (Mg)	µg/L	<50	--	--	--	--	1250	1260	1640	1570	<50	<50
Potassium (K)	µg/L	<50	--	--	--	--	330	370	360	330	<50	<50
Sodium (Na)	µg/L	<50	--	--	--	--	670	680	1370	1340	270	<50
Chloride (Cl)	µg/L	<100	--	--	--	--	240	270	1140	1120	<100	<100
Fluoride (F)	µg/L	<50	1500 ⁽⁷⁾	--	--	--	<50	<50	<50	<50	<50	<50
Sulphate (SO ₄)	µg/L	<100	--	--	--	--	3020	3040	3240	3330	<100	<100
METALS												
Aluminum (Al)	µg/L	<4	--	--	100 ⁽⁸⁾	75 ⁽⁹⁾	53	47	57	54	5	<4
Antimony (Sb)	µg/L	<6	--	6	--	20	<3	<3	<3	<3	<3	<3
Arsenic (As)	µg/L	<3	--	25	5	5	<3	<3	<3	<3	<3	<3
Barium (Ba)	µg/L	<2	1000	--	--	--	5	5	4	4	<2	<2
Beryllium (Be)	µg/L	<1	--	--	--	11 ⁽¹⁰⁾	<1	<1	<1	<1	<1	<1
Boron (B)	µg/L	<10	--	5000	1500 ⁽¹¹⁾	200	<10	<10	<10	<10	<10	<10
Cadmium (Cd)	µg/L	<0.1	--	5	0.058 ⁽¹²⁾	0.1 ⁽¹³⁾	<0.1	<0.1	<0.1	<0.1	<0.1	<0.1
Chromium (Cr)	µg/L	<3	50	--	8.9 ⁽¹⁴⁾	8.9 ⁽¹⁴⁾	<3	<3	<3	<3	<3	<3
Cobalt (Co)	µg/L	<0.5	--	--	--	0.9	<0.5	<0.5	<0.5	<0.5	<0.5	<0.5
Copper (Cu)	µg/L	<2	--	--	2 ⁽¹⁵⁾	5 ⁽¹⁶⁾	<2	<2	<2	<2	<2	<2
Iron (Fe)	µg/L	<10	--	--	300	300	<10	<10	20	30	<10	<10
Lead (Pb)	µg/L	<1	10 ⁽¹⁷⁾	--	1 ⁽¹⁸⁾	3 ⁽¹⁹⁾	<1	<1	<1	<1	<1	<1
Manganese (Mn)	µg/L	<2	--	--	--	--	29	29	8	10	<2	<2
Mercury (Hg)	µg/L	<0.10	1	--	0.026	0.2	<0.1	<0.1	<0.1	<0.1	<0.1	<0.1
Molybdenum (Mo)	µg/L	<2	--	--	73	40	<2	<2	<2	<2	<2	<2
Nickel (Ni)	µg/L	<3	--	--	25 ⁽²⁰⁾	25	<3	<3	<3	<3	<3	<3
Selenium (Se)	µg/L	<4	10	--	1	100	<4	<4	<4	<4	<4	<4
Silver (Ag)	µg/L	<0.1	--	--	0.1	0.1	<0.1	<0.1	<0.1	<0.1	<0.1	<0.1
Strontium (Sr)	µg/L	<5	--	--	--	--	19	19	15	18	<5	<5
Thallium (Tl)	µg/L	<0.3	--	--	0.8	0.3	<0.3	<0.3	<0.3	<0.3	<0.3	<0.3
Titanium (Ti)	µg/L	<2	--	--	--	--	<2	<2	<2	<2	<2	<2
Tungsten (W)	µg/L	<10	--	--	--	30	<10	<10	<10	<10	<10	<10
Uranium (U)	µg/L	<2	20	--	15	5	<2	<2	<2	<2	<2	<2
Vanadium (V)	µg/L	<2	--	--	--	6	<2	<2	<2	<2	<2	<2
Zinc (Zn)	µg/L	<5	--	--	30	20	<5	<5	<5	48	<5	<5
Zirconium (Zr)	µg/L	<4	--	--	--	4	<4	<4	<4	<4	<4	<4
OTHER PARAMETERS												
Total Cyanide	µg/L	<2	--	--	--	--	<2	<2	<2	<2	<2	<2
Free Cyanide	µg/L	<2	--	--	5	5	<2	<2	<2	<2	<2	<2
Phenols	µg/L	<1	--	--	--	5	<1	<1	1	<1	<1	<1
Sulphur (S)	µg/L	<50	--	--	--	--	--	--	--	--	--	--
NUTRIENTS												
Nitrate (NO ₃ ⁻)	µg/L as N	<50	10000	--	13000 ⁽²¹⁾	--	160	150	100	70	<50	<50
Nitrite (NO ₂ ⁻)	µg/L as N	<50	1000	--	60 ⁽²²⁾	--	<50	<50	<50	<50	<50	<50
Total Ammonia (NH ₃)	µg/L as N	<20	--	--	6980	--	70	70	<20	<20	<20	<20
Un-ionized Ammonia (NH ₃)	µg/L	--	--	--	19 ⁽²³⁾	20 ⁽²³⁾	--	--	<0.040	<0.040	--	--
Total Kjeldahl Nitrogen	µg/L	<100	--	--	--	--	--	--	--	--	--	--
Total Phosphorus (TP)	µg/L	<20	--	--	20	20	<20	20	<20	<20	<20	<20
Phosphate (PO ₄)	µg/L as P	<100	--	--	--	--	--	--	--	--	--	--
Soluble Reactive Phosphorus	µg/L	<20	--	--	--	--	--	--	--	--	--	--
ORGANICS												
Oil and Grease (Animal/Vegetable)	µg/L	<500	--	--	--	--	<500	<500	<500	<500	<500	<500
Oil and Grease (Mineral)	µg/L	<500	--	--	--	--	<500	<500	<500	<500	<500	<500
Oil and Grease (Total)	µg/L	<500	--	--	--	physically non detect	<500	<500	<500	<500	<500	<500
Polychlorinated Biphenyls	µg/L	<0.1	--	0.003	--	0.001	<0.1	<0.1	<0.1	<0.1	<0.1	<0.1
Naphthalene	µg/L	<0.2	--	--	1.1	7	<0.2	<0.2	<0.2	<0.2	<0.2	<0.2
Acenaphthylene	µg/L	<0.2	--	--	--	--	<0.2	<0.2	<0.2	<0.2	<0.2	<0.2
Acenaphthene	µg/L	<0.2	--	--	5.8	--	<0.2	<0.2	<0.2	<0.2	<0.2	<0.2
Fluorene	µg/L	<0.2	--	--	3	0.2	<0.2	<0.2	<0.2	<0.2	<0.2	<0.2
Phenanthrene	µg/L	<0.1	--	--	0.4	0.03	<0.1	<0.1	<0.1	<0.1	<0.1	<0.1
Anthracene	µg/L	<0.1	--	--	0.012	0.0008	<0.1	<0.1	<0.1	<0.1	<0.1	<0.1
Fluoranthene	µg/L	<0.2	--	--	0.04	0.0008	<0.2	<0.2	<0.2	<0.2	<0.2	<0.2
Pyrene	µg/L	<0.2	--	--	0.025	--	<0.2	<0.2	<0.2	<0.2	<0.2	<0.2
Benz(a)anthracene	µg/L	<0.2	--	--	0.018	0.0004	<0.2	<0.2	<0.2	<0.2	<0.2	<0.2
Chrysene	µg/L	<0.1	--	--	--	0.0001	<0.1	<0.1	<0.1	<0.1	<0.1	<0.1
Benzo(b)fluoranthene	µg/L	<0.1	--	--	--	--	<0.1	<0.1	<0.1	<0.1	<0.1	<0.1
Benzo(k)fluoranthene	µg/L	<0.1	--	--	--	0.0002	<0.1	<0.1	<0.1	<0.1	<0.1	<0.1
Benzo(a)pyrene	µg/L	<0.01	--	--	0.015	--	<0.01	<0.01	<0.01	<0.01	<0.01	<0.01
Indeno(1,2,3-cd)pyrene	µg/L	<0.2	--	--	--	--	<0.2	<0.2	<0.2	<0.2	<0.2	<0.2
Dibenz(a,h)anthracene	µg/L	<0.2	--	--	--	0.002	<0.2	<0.2	<0.2	<0.2	<0.2	<0.2
Benzo(g,h,i)perylene	µg/L	<0.2	--	--	--	0.00002	<0.2	<0.2	<0.2	<0.2	<0.2	<0.2
2-and 1-methyl Naphthalene	µg/L	<0.2	--	--	--	--	<0.2	<0.2	<0.2	<0.2	<0.2	<0.2
RADIONUCLIDES												
Radium-226	Bq/L	<0.001	0.6	--	--	1 ⁽²⁴⁾	--	--	--	--	--	--
MICROBIOLOGICAL												
Escherichia coli	CFU/100mL	1	--	--	--	--	2	ND	1	ND	ND	--
Total Coliforms	CFU/100mL	1	--	--	--	--	33	48	34	38	ND	--

Quality Assurance/Quality Control Sample Results

Parameter	Unit	Blind Duplicate Sample Laboratory Comparison											
		CL		LCM		3D-c		CHLK		P-6		MESO-OUT	
		Testmark	AGAT	Testmark	AGAT	Testmark	AGAT	Testmark	AGAT	Testmark	AGAT	Testmark	AGAT
pH	pH	6.61	6.71	6.46	6.19	6.71	6.41	6.76	6.51	6.95	6.67	7.09	6.71
Total Suspended Solids	mg/L	0.5	<1	1.3	<1	<0.5	<1	<1	<1	0.75	2	<0.5	1
Electrical Conductivity	µS/cm	50.1	57	38.7	44	42.2	49	44.9	51	83.6	98	55.5	64
Aluminum	µg/L	91	118	51.9	64	63.9	64	74.7	70	74.3	65	50.5	45
Antimony	µg/L	<0.5	<6	<0.5	<6	<0.5	<6	<0.5	<6	<0.5	<6	<0.5	<6
Arsenic	µg/L	<1	<3	<1	<3	<1	<3	<1	<3	1.1	<3	<1	<3
Barium	µg/L	5.9	7	3.8	4	5.1	6	5.9	5	9.6	10	4.5	5
Beryllium	µg/L	<0.5	<1	<0.5	<1	<0.5	<1	<0.5	<1	<0.5	<1	<0.5	<1
Bismuth	µg/L	<1	--	<1	--	<1	--	<1	--	<1	--	<1	--
Boron	µg/L	<2	<10	<2	<10	<2	<10	<2	<10	<2	<10	<2	<10
Cadmium	µg/L	<0.1	<0.1	<0.1	<0.1	<0.1	<0.1	<0.1	<0.1	<0.1	<0.1	<0.1	<0.1
Calcium	µg/L	7070	8240	5490	6270	5590	6490	6260	7250	11500	12500	6830	8160
Cerium	µg/L	<1	--	<1	--	<1	--	<1	--	2.1	--	<1	--
Cesium	µg/L	<1	--	<1	--	<1	--	<1	--	<1	--	<1	--
Chromium	µg/L	<0.8	<3	<0.8	<3	<0.8	<3	<0.8	<3	<0.8	<3	<0.8	<3
Cobalt	µg/L	<0.1	<0.5	0.11	<0.5	<0.1	<0.5	<0.1	<0.5	0.75	0.7	<0.1	<0.5
Copper	µg/L	1.4	<2	<1	<2	<1	<2	<1	<2	1.2	<2	<1	<2
Europium	µg/L	<1	--	<1	--	<1	--	<1	--	<1	--	<1	--
Gallium	µg/L	<1	--	<1	--	<1	--	<1	--	<1	--	<1	--
Iron	µg/L	247	274	63	84	114	99	210	211	1990	1750	76	60
Lanthanum	µg/L	<1	--	<1	--	<1	--	<1	--	<1	--	<1	--
Lead	µg/L	<1	<1	<1	<1	<1	<1	<1	<1	<1	<1	<1	<1
Lithium	µg/L	<5	--	<5	--	<5	--	<5	--	<5	--	<5	--
Magnesium	µg/L	1100	1440	486	840	854	1180	924	1270	2270	2460	1530	1920
Manganese	µg/L	52	60	29.5	31	7.8	9	36	33	2060	1660	9	6
Mercury	µg/L	<0.1	<0.1	<0.1	<0.1	<0.1	<0.1	<0.1	<0.1	<0.1	<0.1	<0.1	<0.1
Molybdenum	µg/L	<1	<2	<1	<2	<1	<2	<1	<2	<1	<2	<1	<2
Nickel	µg/L	<1	<3	<1	<3	<1	<3	<1	<3	<1	<3	<1	<3
Niobium	µg/L	<1	--	<1	--	<1	--	<1	--	<1	--	<1	--
Potassium	µg/L	440	400	290	320	380	430	260	260	320	350	290	320
Rubidium	µg/L	1.2	--	<1	--	1.3	--	<1	--	1.1	--	1.2	--
Scandium	µg/L	<1	--	<1	--	<1	--	<1	--	<1	--	<1	--
Selenium	µg/L	<1	<4	<1	<4	<1	<4	<1	<4	<1	<4	<1	<4
Silicon	µg/L	2260	--	960	--	1670	--	2190	--	4190	--	1820	--
Silver	µg/L	<0.1	<0.1	<0.1	<0.1	<0.1	<0.1	<0.1	<0.1	<0.1	<0.1	<0.1	<0.1
Sodium	µg/L	1150	1010	770	800	1100	1100	860	880	1190	1110	1280	1330
Strontium	µg/L	17.5	21	13.2	14	14.5	14	15.6	14	27.5	23	17.7	18
Sulfur	µg/L	<800	--	<800	--	<800	--	<800	--	<800	--	<800	--
Tellurium	µg/L	<1	--	<1	--	<1	--	<1	--	<1	--	<1	--
Thallium	µg/L	<0.1	<0.3	<0.1	<0.3	<0.1	<0.3	<0.1	<0.3	<0.1	<0.3	<0.1	<0.3
Thorium	µg/L	<1	--	<1	--	<1	--	<1	--	<1	--	<1	--
Tin	µg/L	<1	--	<1	--	<1	--	<1	--	<1	--	<1	--
Titanium	µg/L	1.1	<2	<1	<2	<1	<2	1	<2	1.4	<2	<1	<2
Tungsten	µg/L	<1	<10	<1	<10	<1	<10	<1	<10	<1	<10	<1	<10
Uranium	µg/L	<1	<2	<1	<2	<1	<2	<1	<2	<1	<2	<1	<2
Vanadium	µg/L	<1	<2	<1	<2	<1	<2	<1	<2	<1	<2	<1	<2
Yttrium	µg/L	<1	--	<1	--	<1	--	<1	--	<1	--	<1	--
Zinc	µg/L	10.4	106	1.2	11	3.2	5	<1	<5	1.4	<5	<1	<5
Zirconium	µg/L	<1	<4	<1	<4	<1	<4	<1	<4	<1	<4	<1	<4

NOTES ON COMPARISONS TO WATER QUALITY STANDARDS AND GUIDELINES:

Values in GREY exceed the ODWSs MACs or IMACs

Values in ***bold italics*** exceed the CCME CWQGs

Values underlined exceed the PWQOs

-- indicates no value available

NOTES ON WATER QUALITY STANDARDS AND GUIDELINES:

(1) Total concentrations are assumed, unless stated otherwise.

(2) Ontario Regulation (O.Reg.) 169/03: Ontario Drinking Water Standards (ODWS). Last amendment: O.Reg. 327/08.

http://www.e-laws.gov.on.ca/html/regs/english/elaws_regs_030169_e.htm.

(3) MAC: Maximum Acceptable Concentration; IMAC: Interim Maximum Acceptable Concentration

(4) Canadian Council of Ministers of the Environment (CCME), Canadian Water Quality Guidelines (CWQGs) for the Protection of Aquatic Life, Update 7.1 (December 2007).

(5) Provincial Water Quality Objectives, Ministry of Environment and Energy (1994, Revised 1999).

(6) TSS (CWQG) Under clear flow: + 25 mg/L from background levels for any short-term exposure (e.g., 24-h period).

average + 5 mg/L from background levels for longer term exposures (24 h < discharge < 30 d).

TSS (CWQG) Under high flow: + 25 mg/L from background levels at any time when background levels between 25 and 250 mg/L.

+ 10% of background levels when background is >250 mg/L.

(7) Where fluoride is added to drinking water, it is recommended that the concentration be adjusted to 0.5-0.8 mg/L the optimum level for control of tooth decay. Where supplies contain naturally occurring fluoride at levels higher than 1.5 mg/L but less than 2.4 mg/L the Ministry of Health and Long Term Care recommends an approach through local boards of health to raise public and professional awareness to control excessive exposure to fluoride from other sources.

(8) Aluminium guideline (CWQG) is calculated assuming a pH of 7.0.

(9) Aluminium guideline (PWQO) is calculated assuming a pH of 7.0.

(10) Beryllium guideline (PWQO) is calculated assuming a hardness of 30 mg/L as CaCO₃.

(11) Boron guideline (CWQG) is based on long-term exposure.

(12) Cadmium guideline (CWQG) is based on the Draft Scientific Criteria Document for the Development of the Canadian Water Quality Guidelines for the Protection of Aquatic Life: Cadmium, October 2012, and calculated using an assumed hardness of 30 mg/L as CaCO₃.

(13) Cadmium guideline (PWQO) is calculated assuming a hardness of 30 mg/L as CaCO₃.

(14) No guidelines for total chromium. Guidelines for trivalent chromium used: CWQG and PWQO guidelines for Cr(III) are both 8.9 µg/L.

(15) Copper guideline (CWQG) is calculated assuming a hardness of 30 mg/L as CaCO₃.

(16) Copper guideline (PWQO) is calculated assuming a hardness of 30 mg/L as CaCO₃.

(17) This standard applies to water at the point of consumption. Since lead is a component in some plumbing systems, first flush water may contain higher concentrations of lead than water that has been flushed for five minutes.

(18) Lead guideline (CWQG) is calculated assuming a hardness of 30 mg/L as CaCO₃.

(19) Lead guideline (PWQO) is calculated assuming a hardness of 30 mg/L as CaCO₃.

(20) Nickel guideline (CCME) is calculated assuming a hardness of 30 mg/L as CaCO₃.

(21) For protection from direct toxic effects, the guidelines do not consider indirect effects due to eutrophication.

(22) Guideline is expressed as µg nitrite-nitrogen/L. This value is equivalent to 197 µg nitrite/L.

(23) Un-ionized ammonia is calculated using the equation: $f = 1/(10^{pKa-pH} + 1)$, where f is the fraction of NH₃; $pKa = 0.09018 + 2729.92/T$; T = ambient water temperature in Kelvin ($K = °C + 273.16$) (Emerson et al., 1975)

(24) The PWQO for Ra-226 is based on drinking water requirements, which are derived from dose-response relationships as recommended by the International Commission on Radiological Protection (ICRP) in Publication 26.



ATTACHMENT II

Water Quality Modelling Report, Côté Gold Project



November 10, 2014

IAMGOLD CORPORATION

Water Quality Modelling Report Côte Gold Project

Submitted to:
IAMGOLD Corporation
401 Bay Street, Suite 3200
PO Box 153
Toronto, ON M5H 2Y4

Uploaded via Buzzsaw

REVISED REPORT

Report Number: 13-1192-0021R

Distribution:

1 e-copy - IAMGOLD Corporation
1 copy - Golder Associates Ltd.





Table of Contents

1.0 INTRODUCTION	1
2.0 WATER QUALITY MODELLING	1
2.1 Model Approach	1
2.2 Description of Water Quality Models	2
2.2.1 Operations Phase Model	2
2.2.1.1 Project Site Components	2
2.2.1.2 Receiving Watercourses	4
2.2.2 Post-closure Phase Models	5
2.2.2.1 Post-Closure Phase Stage I Model	5
2.2.2.2 Post-Closure Phase Stage II Model	6
2.3 Water Quality Model Prediction Locations	7
2.4 Modelled Parameters	8
2.5 Input Data	8
2.5.1 Natural Runoff and Process Plant Area Runoff	8
2.5.2 Open Pit Groundwater Seepage	10
2.5.3 Contact Water Runoff and Seepage	11
2.5.3.1 MRA Contact Water	11
2.5.3.2 Low-grade Stockpile Contact Water	16
2.5.3.3 Open Pit Wall Rock Contact Water	16
2.5.3.4 Pit Lake Water Quality	16
2.5.4 Residual Explosives Inputs	17
2.5.5 Tailings Management Facility Runoff and Seepage	19
2.5.5.1 Loading Rate Assumptions	19
2.5.6 Process Water Quality	20
2.6 Key Model Limitations and Assumptions	23
3.0 MODEL RESULTS	24
3.1 Development of Comparison Criteria	24
3.1.1 Effluent Discharge Limits	24
3.1.2 Aquatic and Human Health Criteria	25



3.2	Model Results	25
4.0	REPORT USE LIMITATIONS	25
5.0	REFERENCES.....	26

TABLES

Table 1: Modelled Surface Water Bodies	7
Table 2: Natural and Process Plant Area Runoff Input Water Quality	9
Table 3: Open Pit Groundwater Seepage Input Water Quality	10
Table 4: Lithologies of Humidity Cell Test Samples	12
Table 5: Assumed Lithology-based Tonnages	13
Table 6: Assumed Lithology-based Loading Rates	13
Table 7: Adjustments to Scaled-Up Waste Rock Loading Rates.....	15
Table 8: Explosives Composition and Nitrogen Species Weight Proportions.....	17
Table 9: Residual Mass of Nitrogen Species.....	18
Table 10: Assumed Process Water Quality.....	20
Table 11: Assumed Monthly Rate Constants for Cyanide Degradation	22

FIGURES

Figure 1 – Project Location
Figure 2 – General Site Plan
Figure 3 – Operations Flow Schematic
Figure 4 – Post-closure Phase Stage I Flow Schematic
Figure 5 – Post-closure Phase Stage II Flow Schematic
Figure 6 – Prediction of Water Quality Effects Locations
Figure 7 – Baseline Surface Water Quality Monitoring Stations
Figure 8 – Baseline Groundwater Quality Monitoring Stations

APPENDICES

APPENDIX A

Water Quality Model Results: Operations Phase

APPENDIX B

Water Quality Model Results: Post-closure Phase Stage I

APPENDIX C

Water Quality Model Results - Post-closure Phase Stage II



1.0 INTRODUCTION

IAMGOLD intends to develop the Côté Gold Project (the Project) in the District of Sudbury, in northeastern Ontario, approximately 20 kilometres (km) southwest of Gogama, 130 km southwest of Timmins, and 200 km northwest of Sudbury (Figure 1). Golder Associates Ltd. (Golder) has prepared water quality models for different phases of the Project. The key objective of the water quality modelling was to estimate the water quality of the Project site drainage and potential changes to water quality in the receiving surface water environment that may occur as a result of the Project. The Project infrastructure and surrounding watercourses are presented in Figure 2.

This water quality modelling report is an Attachment of the Water Quality Technical Support Document (Water Quality TSD; Golder 2013a), which itself is part of a broader Environmental Impact Statement (EIS) of the Project. The purpose of this report is to describe the modeling approach, input data and assumptions, and provide the complete set of results from the water quality modelling. Some of the supporting water quality characterization and conceptual model development that form the basis of the water quality models are detailed in the TSD and are not repeated herein. Furthermore, the flow input data are derived from the water balances that are based upon the hydrologic and hydrogeologic conceptual models, which are detailed in the respective TSDs. As such, it is suggested that the reader consult the Water Quality, Hydrology and Climate, and Hydrogeology TSDs (Golder 2013a, Golder 2013b and Golder 2013c, respectively) prior to reading this report.

2.0 WATER QUALITY MODELLING

2.1 Model Approach

In support of the water quality component of the EIS, deterministic water quality models were developed for the Project using GoldSim Version 10.5. GoldSim is a graphical, object-oriented mathematical modelling program where all input parameters and functions are defined by the user and are built as individual objects or elements linked together by mathematical expressions. The object-based nature of the program is designed to facilitate an understanding of the various factors that control an engineered or natural system and predict potential changes to the system.

The modelling approach for the water quality predictions is through the use of mass-balance mixing cell models that consists of a number of site-specific components: both natural components (e.g., precipitation, lakes, watercourse reaches) and Project-site components (e.g., effluent discharge), that are linked together to form a series of mixing cells based on the flow logic within the Project site and receiving environment. Each mixing cell has two or more sources of mass load that are combined to determine a “mixed” or combined water quality. A mass-balance mixing cell model was developed in GoldSim for each of the operations phase, post-closure phase stage I and post-closure phase stage II; a discussion on the Project phases that were included in the water quality modeling (i.e., temporal boundaries) for the effects predictions can be found in the Water Quality TSD (Golder 2013a).

The water balances for the operations and post-closure phases (see Hydrology and Climate TSD; Golder 2013b) are the basis for the flow rate inputs into the water quality models. The water balance logic is used to configure the model linkages, including determining the direction of mass movement along the flow paths and defining the location of mass mixing points. The flow rates were used with baseline water quality and geochemistry inputs to derive mass loading rates for each of the model components. The mass mixing can be represented by the following equation:



$$C = \sum_{i=1}^n C_i F_i$$

where:

- C = predicted concentration in the waterbody (milligrams per litre [mg/L]);
- C_i = concentration in inflow 'i' discharging into the waterbody (mg/L);
- F_i = flow proportion of inflow 'i' discharging into waterbody (unitless);
- n = number of inflows (unitless).

Each flow proportion is multiplied by the corresponding input concentration value, and the sum of all these calculations is used to predict the final concentration of each parameter in the waterbody.

2.2 Description of Water Quality Models

Three water quality models were developed for the Project to predict potential changes to water quality during each of the operation phase, post-closure phase stage I and post-closure phase stage II. Potential changes to water quality during the construction and closure phases of the Project can be inferred based on the results predicted for the operations and post-closure phases.

Average climate conditions were modelled for each Project phase, and return periods of 25 years were used to derive the water quality predictions for the dry and wet conditions. Modelling the three climate conditions for the operations and post-closure phases provides a framework for the range of expected site and receiving surface water qualities.

Simplified schematics of the flow logic for the operations, post-closure phase stage I and post-closure phase stage II models are presented on Figures 3, 4 and 5, respectively.

2.2.1 Operations Phase Model

2.2.1.1 Project Site Components

To predict the water quality of Project site effluents, and to assess the impacts of the Project on the receiving environment, the Project site components that were considered in the operations phase water quality model include:

- Mine Rock Area (MRA);
- low-grade stockpile;
- open pit;
- Tailings Management Facility (TMF);
- mine water pond; and
- polishing pond.



Descriptions of these Project site components, and how these components are expected to influence Project site water quality, are presented below.

Mine Rock Area and Low-grade Stockpile

Mine rock will be stored in the MRA, which is estimated to have an area of about 450 ha and ultimately contain about 650 million tonnes (Mt) of mine rock. The MRA is bounded by Three Duck Lakes to the east, the open pit (formerly Côté Lake) to the northwest, Chester Lake to the west, and Delaney Lake to the south.

Low-grade ore will be stored during the operations phase in the low-grade stockpile, which is estimated to have an area of about 65 ha and ultimately contain about 260 Mt of low-grade ore. The low-grade stockpile is located to the north of the open pit and east of the processing plant.

Subaerial storage of mine rock and low-grade ore in the MRA and low-grade stockpile, respectively, will result in the rock being exposed to atmospheric conditions. The exposed rock surfaces, in particular the fine grained portions, are susceptible to weathering processes that can lead to the mobilization of constituents through oxidation and dissolution reactions. In addition to the weathering by-products, residual explosives from blasting can persist in the mine rock, which are water soluble and sources of ammonia and nitrate.

Water that infiltrates into the MRA and low-grade stockpile can interact (come into contact) with the weathered rock surfaces and residual explosives; this water is referred to as “contact” water. The water-rock interaction results in the mobilization of soluble constituents (i.e., major ions, metals and nitrogen species) present in the mine rock. The runoff and seepage water, or contact water, from the MRA and low-grade stockpile will report to Mine Rock Storage Ponds (MRSPs) and the storage ponds around the low-grade stockpile, the water quality of which will be strongly influenced by the rock reactivity, degree of water-rock interactions and amounts of soluble explosive residues.

Open Pit

The excavation of mine rock and development of the open pit results in the rock face of the pit walls being exposed to atmospheric conditions. The blasting of the rock typically results in a “damaged zone” of rock that consists of shallow fractures that extend into the bedrock from the face of the pit wall. The surfaces of the fractures in the damaged zone are also exposed to atmospheric conditions. The exposed rock surfaces are susceptible to weathering processes that can lead to the mobilization of constituents through oxidation and dissolution reactions. As with mine rock, explosive residues can persist on the pit walls, and within blasted mine rock fines that remain in the open pit, which are a source of ammonia and nitrate.

Water that comes into contact with the exposed rock surfaces (i.e., direct precipitation, groundwater inflow and runoff from the open pit catchment area) can transport soluble constituents into the pit sump, which affects its water quality. Open pit wall runoff due to groundwater inflow, direct precipitation and pit catchment inputs is assumed to report to a central pit sump for temporary storage.

Tailings Management Facility and Reclaim Pond

Tailings are produced as part of ore processing and will be stored in the TMF, which is a subaerial facility. Subaerial deposition of tailings results in exposure to atmospheric conditions, and the tailings are therefore susceptible to weathering processes, such as oxidation and dissolution reactions. Runoff across the surface of



the tailings and seepage water that infiltrates through the tailings pore space can mobilize constituents that are by-products of tailings oxidation. The seepage water from the TMF can also carry constituents associated with process water (i.e., cyanide, ammonia and metals).

Tailings will be discharged from perimeter containment dams with drainage directed towards a central reclaim pond located within the TMF footprint. Water in the reclaim pond will be recycled back to the process plant. Seepage water that is collected at the Tailings Dam Seepage Ponds (TDSPs) will be pumped to the reclaim pond.

Mine Water Pond and Polishing Pond

Water temporarily stored in the mine water pond will be used to assist with fulfilling process plant demands, with the excess water being routed to the polishing pond. As such, the water quality in the polishing pond will consist of contact water and natural runoff from the MRA, low-grade stockpile and open pit catchment areas. During periods when there is excess water in the polishing pond and storage available in the TMF, water will be pumped from the polishing pond to the reclaim pond. However, during periods when there is excess water in the polishing pond and no available storage in the TMF, the excess water in the polishing pond will be discharged to the environment, according to federal and provincial metal mining sector effluent discharged requirements.

The water management strategy has been designed to maintain a closed-loop between the processing plant and the reclaim pond; that is, the water from the reclaim pond does not report to the polishing pond, but rather is recycled back to the processing plant to reduce the requirements for freshwater make-up. As such, the water quality model assumes that the treated effluent discharge from the site does not contain cyanide from the processing plant, nor any constituents generated by the cyanide leaching or destruction process.

2.2.1.2 Receiving Watercourses

The Project is located approximately 3.5 km north of the Great Lakes/James Bay watershed divide. Drainage pathways from the Project site fall within one of two watersheds:

- 1) Mollie River Watershed; or
- 2) Mesomikenda Lake Watershed.

The drainage patterns within the two watersheds, which form the basis of the linkages between the surface water body locations in the water quality models, are described below.

Mollie River Watershed Drainage Pattern

Chester Lake is located in the southwestern portion of the Mollie River Watershed. Chester Lake flows northward via a realignment channel to Clam Lake, which flows northeastward via a realignment channel along the west side of the open pit to Little Clam Lake. Little Clam Lake flows eastward through a beaver pond into the southern portion of Bagsverd Lake (south), which is separated from the northern portion of Bagsverd Lake by a realignment dam. Bagsverd Lake (south) flows eastward into Weeduck Lake. The Mollie River system then continues southward through a realignment channel to Three Duck Lakes, which consists of three basins: upper, middle and lower. Outflow from Three Duck Lakes then continues southward through the Mollie River system



and merges with drainage from Delaney Lake. After the confluence with drainage from Delaney Lake, the Mollie River then flows eastward to Dividing Lake, which marks the downstream end of the Mollie River Watershed.

Mesomikenda Lake Watershed Drainage Pattern

To the north of the open pit footprint, Bagsverd Lake drains northward via the Bagsverd Creek realignment channel to Unnamed Lake #1. Bagsverd Creek continues to flow north and then around a bend to the east and into Neville Lake. The outflow of Neville Lake discharges into Mesomikenda Lake, which consists of four general basins that are referred to as lower, middle, upper/middle and upper. The downstream end of the Mesomikenda Lake Watershed is marked by the upper basin of Mesomikenda Lake, which receives the inflow from Neville Lake.

Treated Effluent Discharge Alternatives

An alternatives analysis was completed to evaluate two options for discharge of treated effluent to the receiving surface water environment. Two alternatives evaluated using the operations phase water quality model are:

- 1) **Operations Phase – Bagsverd Creek Treated Effluent Discharge Option:** This scenario was modelled to simulate surface water quality conditions assuming treated effluent would be discharged at the downstream end of Bagsverd Creek. It is assumed that the lower basin of Neville Lake will be used as a mixing zone, with the downstream end of the mixing zone being the Neville Lake outflow.
- 2) **Operations Phase – Mesomikenda Lake Treated Effluent Discharge Option:** This scenario was modelled to simulate surface water quality conditions assuming treated effluent would be discharged to the upper-middle basin of Mesomikenda Lake. It is assumed that the upper-middle basin of Mesomikenda Lake will be used as a mixing zone, with the downstream end of the mixing zone being the outflow of the upper-middle basin to the upper basin of Mesomikenda Lake.

The results of the treated effluent discharge alternatives analysis is presented in the Water Quality TSD.

2.2.2 Post-closure Phase Models

Two separate post-closure phase water quality models were developed through modifications to the operations phase model, which were made in accordance with the conceptual closure plan (AMEC 2013a):

- 1) **Post-closure Phase Stage I:** This model was developed to simulate conditions following closure of the mine components, during the period in which the pit is flooding (i.e., no discharge from the open pit).
- 2) **Post-closure Phase Stage II:** This model was developed to simulate conditions when the open pit is completely flooded and assimilated within the receiving environment (i.e., the Mollie River system).

The details and changes to the flow logic for the post-closure phase models are described below.

2.2.2.1 Post-Closure Phase Stage I Model

Once mining at the Project site is complete, dewatering activities will cease and the open pit will be allowed to flood. Water input that will contribute to the pit flooding will consist of groundwater inflow and runoff from the adjacent catchment area, including runoff from the decommissioned mine water pond area, process plant area,



former low-grade stockpile area, and the northern portion of the MRA. Under post-closure conditions, the open pit is estimated to return to the approximate elevation of Côté Lake after approximately 50 to 80 years following the decommissioning of the pit sump pumps (see Hydrology and Climate TSD; Golder 2013b).

Based on the closure concept, the water quality modeling assumes that the Project site facilities will be decommissioned and rehabilitated during the closure phase. A vegetated soil cover will be constructed over the surface of the TMF, polishing pond and approximately 25% of the MRA. Runoff and seepage from the TMF will be monitored to determine whether it is suitable for discharge to the environment (i.e., protective of aquatic life). If the TMF runoff is determined to be suitable for release to the environment, it will be allowed to passively discharge toward the east and into a natural channel that reports to the middle basin of Mesomikenda Lake; otherwise, the TMF runoff and seepage will continued to be captured and treated, as required. Similarly, surplus from the polishing pond will be monitored and, if the water quality is determined to be suitable for discharge to the environment, drainage from the polishing pond will be allowed to passively discharge into Bagsverd Creek.

Runoff and seepage collected from the MRA will be pumped to the open pit during the post-closure phase stage I. Erosion and sediment transport controls will be maintained, as required, until vegetation has sufficiently been established to act as a natural mitigation measure.

The process plant and associated infrastructure will have already been decommissioned and demolished prior to post-closure, and plant and camp site areas will be revegetated. The low-grade ore stockpile will not be present on the Project site during post-closure, as it is assumed that all low-grade ore will be processed before entering the closure phase.

It is assumed that any soluble explosive residues will not remain within the MRA or open pit after a prolonged period of water-rock interactions; as such, residual explosives loadings were assumed to be negligible for the post-closure models.

2.2.2.2 Post-Closure Phase Stage II Model

The water quality model concept for the post-closure phase stage II is based on modifications to the stage I model, which account for the changes to the Project site hydrology. Once the open pit has flooded to equilibrium levels, runoff and seepage from the MRA will no longer be collected and pumped to the open pit, and will be allowed to passively discharge to the environment. The water quality of the runoff and seepage from the MRA will be monitored during the operations and closure phases to determine if the water quality is suitable for discharge. If the operational and closure monitoring determines that the water quality is not suitable for passive discharge to the environment, remedial action plans will be implemented, including collection and treatment, as required.

Changes to the drainage patterns across the Project footprint will also occur during post-closure phase stage II. The watercourse realignments between Clam Lake and Little Clam Lake will be decommissioned and the dam mitigating flow from Clam Lake into the pit catchment area will be breached. Furthermore, additional changes to the Project site hydrology will result from the decommissioning of the watercourse realignment between Bagsverd Lake (south) and Weeduck Lake, and breaching the dam between the main and south part of Bagsverd Lake. These changes will direct the drainage from Clam Lake into the Côté Pit Lake, similar to pre-mining conditions. The surplus from the Côté Pit Lake will flow into Three Duck Lakes (upper). Weeduck Lake will become a headwater lake and continue to flow into Three Duck Lakes (upper). Little Clam Lake will also



become a headwater lake, with the surplus reporting to Bagsverd Lake and then north through the realigned Bagsverd Creek system.

The drainage patterns for the remainder of the Project site during post-closure phase stage II are assumed to be consistent with post-closure phase stage I.

2.3 Water Quality Model Prediction Locations

Water quality predictions were completed for Project site components that have the potential to affect the overall site water quality; these are: open pit sump, MRA runoff and seepage, low-grade stockpile runoff and seepage, mine water pond, reclaim pond and polishing pond. To assess the impacts of the Project on the receiving surface water environment, surface water bodies were selected for the different Project phases to include lakes that are located adjacent to or downstream of the Project site components. The receiving modelled surface water quality locations are listed in Table 1 and shown on Figure 6.

Table 1: Modelled Surface Water Bodies

Watershed	Modelled Surface Water Bodies
Mollie River Watershed	Chester Lake
	Clam Lake
	Little Clam Lake ⁽¹⁾
	Côté Lake (Pit Lake) ⁽²⁾
	Bagsverd Lake (south)
	Weeduck Lake
	Three Duck Lakes (upper/middle basin)
	Three Duck Lakes (lower basin)
	Delaney Lake
	Dividing Lake
Mesomikenda Lake Watershed	Bagsverd Lake
	Un-named Lake #1
	Bagsverd Creek
	Bagsverd Creek (treated effluent discharge location) ⁽³⁾
	Neville Lake (lower basin, mixing zone) ⁽⁴⁾
	Neville Lake ⁽⁵⁾
	Mesomikenda Lake (upper/middle basin, mixing zone) ⁽⁶⁾
Mesomikenda Lake (upper basin)	

Notes:

- (1) Modelled during operations phase and post-closure phase stage I only.
- (2) Modelled during post-closure phase stage II only.
- (3) Modelled for operations phase, Bagsverd Creek treated effluent discharge option only.
- (4) Modelled for operations phase, Bagsverd Creek treated effluent discharge option only. "Neville Lake (lower)" refers to the lower basin of Neville Lake only, and not the entire lake.
- (5) Refers to entire extent of Neville Lake; modelled for operations phase, Mesomikenda Lake treated effluent discharge option, and post-closure phase stages I and II.
- (6) Modelled for operations phase, Mesomikenda Lake treated effluent discharge option only.



2.4 Modelled Parameters

The parameters included in the model are as follows: aluminum, ammonia (total and un-ionized), antimony, arsenic, barium, boron, cadmium, calcium, chloride, cobalt, copper, cyanide (total and free), iron, lead, magnesium, manganese, molybdenum, nickel, nitrate, phosphorus (total), potassium, sodium, strontium, sulphate, uranium, vanadium and zinc.

The following parameter concentrations were below reported detection limits in the humidity cell test data, or are assumed to not have a Project-related source, and therefore are not included in the results of the water quality predictions: beryllium, bismuth, chromium, fluoride, lithium, mercury, nitrite, selenium, silver, titanium, thallium, tungsten, and zirconium. In addition, pH, alkalinity, dissolved oxygen, temperature and total suspended solids (TSS) concentrations were not modeled; for the following reasons:

- pH and alkalinity - Based on the geochemistry data that is available, the mine rock and tailings are expected to be non-acid generating (AMEC 2013b). Drainage from the mine site and its operations are therefore not expected to significantly change the pH and alkalinity in the receiving environment from the values observed in the surface water quality baseline study.
- Dissolved oxygen and temperature – The effluent discharged from the polishing pond is not expected to have reducing redox characteristics or temperatures that vary significantly from the receiving environment. Furthermore, based on the information that is currently available, the effluent discharge is not expected to alter the physical mixing behavior of the receiving lakes.
- Total suspended solids (TSS) - The transport of TSS is highly influenced by site-specific hydrological conditions, particularly the design of the water management system. Engineered control structures, such as the collection and polishing ponds, are being incorporated into the pre-feasibility site design to allow for settlement of TSS at specific points in the drainage collection system. As such, the engineered control measures will be designed and Best Management Practices (BMPs; see Water Quality TSD Report) to reduce the TSS concentrations to below the effluent discharge limits.

2.5 Input Data

2.5.1 Natural Runoff and Process Plant Area Runoff

Baseline surface water quality monitoring was conducted during 2011, 2012 and 2013 at various watercourses in the vicinity of the Project site. The surface water quality sampling locations are shown on Figure 7.

The input water qualities for the watercourses were derived from baseline surface water quality data collected by IAMGOLD between September 2011 and May 2013 and water column profile sampling conducted by Golder in May 2013. An average baseline surface water quality was calculated using baseline data from the following water features: Clam Lake (CM, CM-LS1), Chester Lake (CHLK, CHLK-LS), small seasonal ponds (P-2, P-5), Côté Lake (CL), Weeduck Lake (WD), the inflow to Three Duck Lakes (P-7), Three Duck Lakes (3D-c, 3D-LS1, 3D-LS2), the inflow to the Mollie River (P-4), Little Clam Lake (LCM), the inflow to Bagsverd Lake (P-3, P-6), Schist Lake (SL), Bagsverd Creek (BPD, BL-a, BL-b), Unnamed Lake #2 (L2), Wolf Lake (WL-1), Somme River (SR), Neville Lake (NL, NEV-LS), Mesomikenda Lake (MESO-OUT, MESO-LS2, MESO-LS4, MESO-LS5, MESO-LS7), Delaney Lake (DEL-LS) and Dividing Lake (DIV-LS). Values below the method detection limits were assumed to be equal to one-half the detection limit.



In August 2013, IAMGOLD submitted a subset of samples for analysis with lowered detection limits. The average baseline concentration was adjusted for all parameters whose concentrations were below the lowered detection limits (antimony and cadmium) to be one-half of the lower detection limit.

Total phosphorus in the baseline surface water quality samples collected by IAMGOLD was analyzed via mass spectrometry to a reported detection limit of 0.02 mg/L. In August 2013, IAMGOLD submitted a subset of samples for analysis via spectrophotometry (to a lower reported detection limit of 0.006 mg/L). The input value for total phosphorus was derived from the results of samples analyzed via spectrophotometry to the lower reported detection limit.

The average baseline surface water quality, including adjustments made as described above, is presented in Table 2; this water quality was used in the water quality model to define the input water qualities for natural runoff and runoff from processing plant area, diversion ditches and dams (i.e., the open pit perimeter dams at Clam Lake, Three Duck Lakes and Chester Lake), and the Project site components that are covered during the post-closure phases (i.e., the polishing pond, TMF).

Table 2: Natural and Process Plant Area Runoff Input Water Quality

Parameter	Average Surface Water Baseline Concentration (mg/L)
Aluminum	0.046
Ammonia (Total)	0.049
Ammonia (Un-ionized)	N/A ⁽¹⁾
Antimony	0.00025
Arsenic	0.0015
Barium	0.0057
Boron	0.0050
Cadmium	0.000020
Calcium	7.3
Chloride	0.71
Cobalt	0.00027
Copper	0.0010
Cyanide (Total)	0.0015
Cyanide (Free)	0.00036
Iron	0.17
Lead	0.000051
Magnesium	1.3
Manganese	0.058
Molybdenum	0.0010
Nickel	0.0015
Nitrate	0.061
Phosphorus (Total)	0.013



Parameter	Average Surface Water Baseline Concentration (mg/L)
Potassium	0.34
Sodium	1.0
Strontium	0.017
Sulphate	3.0
Uranium	0.0010
Vanadium	0.0010
Zinc	0.0087

Notes:

mg/L – milligram per litre

(1) Un-ionized ammonia is not assigned an input value, but rather is calculated within the model using average monthly field pH and field temperature at each of the locations.

2.5.2 Open Pit Groundwater Seepage

Baseline groundwater quality monitoring was conducted during 2012 at various watercourses in the vicinity of the Project site. The groundwater quality sampling locations are shown on Figure 8. The input water quality for groundwater seepage into the open pit was derived from baseline groundwater quality data collected by IAMGOLD between May 2012 and December 2012.

The 75th percentile baseline concentrations of samples collected from the bedrock groundwater wells in the vicinity of the open pit were used to define the input values for groundwater seepage to the open pit. The groundwater wells used to derive the groundwater seepage input included: BH12-1, BH12-2A, BH12-3A, BH12-4, BH12-6, BH12-BULK1 and DH12-PO-10. The groundwater seepage input values are summarized in Table 3.

Table 3: Open Pit Groundwater Seepage Input Water Quality

Parameter	75th Percentile Baseline Groundwater Concentration (mg/L)
Aluminum	0.032
Ammonia (Total)	0.040
Ammonia (Un-ionized)	0.010
Antimony	0.003
Arsenic	0.0015
Barium	0.035
Boron	0.012
Cadmium	0.000050
Calcium	47
Chloride	1.8
Cobalt	0.00025
Copper	0.0035



Parameter	75 th Percentile Baseline Groundwater Concentration (mg/L)
Cyanide (Total)	N/A ⁽¹⁾
Cyanide (Free)	N/A ⁽¹⁾
Iron	0.042
Lead	0.0005
Magnesium	6.1
Manganese	0.115
Molybdenum	0.061
Nickel	0.0023
Nitrate	0.13
Phosphorus (Total)	N/A ⁽²⁾
Potassium	1.5
Sodium	6.1
Strontium	0.061
Sulphate	21.8
Uranium	0.0075
Vanadium	0.001
Zinc	0.034

Notes:

mg/L – milligram per litre

(1) There is assumed not to be a source of cyanide to the groundwater seepage to the open pit.

(2) Total phosphorus was not measured in the baseline groundwater quality program.

2.5.3 Contact Water Runoff and Seepage

For the purposes of modelling, “contact water” is defined as water that interacts with exposed rock or tailings. The sources of contact water therefore include the following Project site components:

- MRA;
- low-grade stockpile;
- open pit; and
- TMF.

In addition, process water from the process plant will affect the water quality of the reclaim pond and TMF seepage. The derivation of the process water quality input and the MRA, low-grade stockpile, open pit and TMF contact water quality inputs are discussed below.

2.5.3.1 MRA Contact Water

Contact water loading rates from the MRA were derived from estimates of rock tonnage and the results of humidity cell testing. Expected tonnages of mine rock over the Project life-of-mine were provided by G Mining



Services Inc. (G Mining 2013, pers. comm.) and AMEC (AMEC 2013, pers. comm.). Lithology-specific loading rates were assigned based on the relative tonnage proportions of the different rock lithologies and the results of humidity cell testing of 14 rock samples (labeled HC-1 through HC-14) from the Project. AMEC provided loading rates (in mg/kg/week) for the 14 humidity cell test samples, as well as sample lithologies and leach test data. The loading rates from week 0 to week 20 were not included in the load calculations, as it was assumed that these represented “first flush” conditions and are not representative of longer term, “steady state” conditions expected at the end of operations when the site facilities are at ultimate extents. As such, loading rates from weeks 20 through 34 were used to derive the loading rates; noting that kinetic testing is ongoing and expected to continue beyond the date of this report.

The lithologies of the 14 humidity cell test samples are presented in Table 4.

Table 4: Lithologies of Humidity Cell Test Samples

Humidity Cell Sample ID	Lithology
HC-1	Tonalite
HC-2	Tonalite
HC-3	Tonalite
HC-4	Tonalite
HC-5	Magma Mixing Breccia
HC-6	Tonalite
HC-7	Magma Mixing Breccia
HC-8	Tonalite
HC-9	Diorite
HC-10	Diorite
HC-11	Diorite Breccia
HC-12	Diorite Breccia
HC-13	Diorite
HC-14	Diorite

Note:
Humidity cell lithologies provided by AMEC (pers. comm., AMEC, November 2013).

The lithologies represented by the humidity cell test samples were assigned the tonnage and percentage distribution for that lithology as provided by AMEC (AMEC 2013, pers. comm.). For the purposes of modelling, lithologies that were not represented by the 14 humidity cell test samples were grouped together and termed “Other Lithologies”. It is assumed that the humidity cell results for the 14 lithologies represent the range of geochemical conditions that will be encountered through mining of the open pit.

Early iterations of the water quality model indicated that arsenic may be a parameter of concern; as a result, a review of the humidity cell test results for weeks 0 through 34 was completed to evaluate potential trends in the arsenic data. The humidity cell results indicate that the arsenic concentrations in two diorite samples (HC-9 and HC-14) were higher than the other two diorite samples (HC-10 and HC-13). The average loading rate taken from all the humidity cells, which was originally inputted into the water quality models, was biased high due to the results of HC-9 and HC-14. To formulate more reasonable humidity cell loading rate inputs, the cumulative percent frequency plot of arsenic concentrations (see AMEC 2013e) that were measured in the overall geochemistry dataset was analyzed versus the concentrations measured in the humidity cell samples. Using the



corresponding arsenic concentrations measured in the humidity cells, it was assumed that 95% of waste rock samples will have an arsenic concentration less than 5.8 µg/g. As such, the diorite samples were split into two lithologies: “higher arsenic” diorite (comprising 5% of the diorite tonnage) and “lower arsenic” diorite (comprising 95% of the diorite tonnage).

Table 5 presents the assumed lithology-based tonnages that were applied in the models for the respective lithology types.

Table 5: Assumed Lithology-based Tonnages

Lithology	Percent (%)	Tonnage (t)
Tonalite	64	420,730,537
Magma Mixing Breccia	1	7,266,236
“Higher Arsenic” Diorite	1	6,556,128
“Lower Arsenic” Diorite	19	124,566,442
Diorite Breccia	8	51,516,071
Other Lithologies	7	44,008,911

The lithology-specific loading rate for each lithology type in Table 5 was assigned based on the median loading rate from weeks 20 to 34 for that lithology. For the purposes of statistical calculation, parameter concentrations less than the reported detection limit were assumed to be equal to one-half the reported detection limit. The loading rate for “Other Lithologies” was assigned the median loading rate of all lithologies, excluding the “higher arsenic” diorite. The median loading rate calculated for each lithology is presented in Table 6.

Table 6: Assumed Lithology-based Loading Rates

Parameter	Lithology-based Loading Rates (mg/kg/week)					
	Tonalite	Magma Mixing Breccia	“Higher Arsenic” Diorite	“Lower Arsenic” Diorite	Diorite Breccia	Other Lithologies
Aluminum	0.053	0.053	0.073	0.071	0.051	0.056
Ammonia (Total)	N/A	N/A	N/A	N/A	N/A	N/A
Ammonia (Un-ionized)	N/A	N/A	N/A	N/A	N/A	N/A
Antimony	0.00026	0.00025	0.00018	0.00018	0.00027	0.00026
Arsenic	0.00066	0.00066	0.00393	0.00075	0.00094	0.00066
Barium	0.00066	0.0015	0.0011	0.0012	0.0020	0.00080
Boron	0.00060	0.00065	0.00063	0.00051	0.00063	0.00056
Cadmium	0.0000015	0.0000026	0.0000015	0.0000015	0.0000015	0.0000015
Calcium	4.7	4.5	4.7	5.0	4.4	4.7
Chloride	0.20	0.26	0.21	0.20	0.20	0.20
Cobalt	0.000029	0.000051	0.000058	0.000042	0.000041	0.000040
Copper	0.00025	0.00057	0.00037	0.00039	0.0011	0.00025
Cyanide (Total)	N/A	N/A	N/A	N/A	N/A	N/A



Parameter	Lithology-based Loading Rates (mg/kg/week)					
	Tonalite	Magma Mixing Breccia	"Higher Arsenic" Diorite	"Lower Arsenic" Diorite	Diorite Breccia	Other Lithologies
Cyanide (Free)	N/A	N/A	N/A	N/A	N/A	N/A
Iron	0.0015	0.0015	0.0015	0.0015	0.0015	0.0015
Lead	0.00001	0.000022	0.00001	0.00001	0.000028	0.00001
Magnesium	0.076	0.092	0.15	0.12	0.20	0.11
Manganese	0.0058	0.0071	0.0043	0.0060	0.0092	0.0059
Molybdenum	0.00023	0.00293	0.00058	0.00025	0.00067	0.00023
Nickel	0.000050	0.000050	0.000050	0.00012	0.000091	0.000050
Nitrate	N/A	N/A	N/A	N/A	N/A	N/A
Phosphorus (Total)	0.010	0.010	0.010	0.012	0.013	0.011
Potassium	0.15	0.74	0.48	0.66	0.55	0.38
Sodium	0.088	0.086	0.086	0.070	0.086	0.081
Strontium	0.0073	0.0062	0.0079	0.0085	0.0088	0.0073
Sulphate	0.31	1.4	0.28	0.31	0.71	0.41
Uranium	0.00060	0.00046	0.00029	0.00065	0.00041	0.00052
Vanadium	0.00017	0.00019	0.00068	0.00062	0.00022	0.00019
Zinc	0.0010	0.0010	0.0010	0.0010	0.0010	0.0010

Note:

mg/kg/week – milligram per kilogram per week

N/A = not applicable. The MRA waste rock is not expected to contain cyanide species. Ammonia and nitrate loading rates were not measured in the humidity cell test samples.

Key variables that are different between laboratory-scale and full field-scale leaching rates include: temperature, reactive surface area, particle size, gas transport, and other site-specific important characteristics. Because the particle size distribution of materials used in the humidity cell test work are finer grained than typically observed in a mine rock pile, the scaled-up loading rates for mine rock were adjusted using a factor of 0.1; this assumption implies that the particle size of about 10% percent passing in a mine rock pile is the same as the average particle size in the humidity cell samples and that the finer particles are the most reactive and therefore produce the vast majority of the oxidation products.

Given that humidity cell tests are completed on relatively homogenous materials, the purpose of the water-rock interaction adjustments are to account for the effect to mass loading rates due to water flowing through preferential flow pathways in the mine rock pile (Nichol et. al, 2005; Guerin et. al, 2006; Marcoline et al., 2006). Rather than applying a single water-rock interaction adjustment factor, an adjustment factor was applied for each month of the year to account for seasonal differences. The adjustment factors for each month are weighted based on the differences in the monthly average surplus calculated for the MRA. It is assumed that a maximum of 19% of the total oxidation products in the mine rock pile (14% non-dry season months + 5% distribution of cold season loads – see Table 7) are available to be flushed due to water-rock interactions during any single month, which is assumed to occur in April. For the months thereafter, the percentage of total oxidation products available for release is assumed to be proportional to the average monthly rainfall for each month relative to



April. The cold-season loads, or the mass load available for release during the winter months, is not released during the winter months, but is rather held as stored oxidation products and then added to the spring freshet mass load by distributing the cold-season loads over March, April, and May. This general approach is reasonable given that 100% of the oxidation products will not be available for release and some mass remains stored in the mine rock pile for future release.

Table 7 presents the adjustments to the scaled-up loadings applied to the MRA. The total adjustment factor was calculated by multiplying the grain size adjustment by the water-rock interaction adjustment (the sum of the non-dry season months and the distribution of the cold-season loads).

Table 7: Adjustments to Scaled-Up Waste Rock Loading Rates

Month	Grain Size Adjustment ⁽¹⁾	Water-Rock Interaction Adjustments ⁽²⁾		Total Adjustment Factor
		Non-dry Season Months	Distribution of Cold-Season Loads	
January	0.1	0.00	-	0
February	0.1	0.00	-	0
March	0.1	0.04	0.02	0.006
April	0.1	0.14	0.05	0.019
May	0.1	0.15	0.02	0.017
June	0.1	0.09	-	0.009
July	0.1	0.08	-	0.008
August	0.1	0.08	-	0.007
September	0.1	0.10	-	0.01
October	0.1	0.09	-	0.009
November	0.1	0.06	-	0.006
December	0.1	0.00	-	0

Note:

(1) Accounts for differences in grain size distribution between the pulverized kinetic test samples and mine rock at the site.

(2) Accounts for unsaturated flow conditions and the formation of preferential flow.

The lithology-based loading rates presented in Table 6 were multiplied by the lithology-based tonnages presented in Table 5 and the Total Adjustment Factor presented in Table 7 to calculate the MRA contact water load in mass per time (kg/d).

The concentration of aluminum is assumed to be controlled by the low solubility of aluminum hydroxides under near-neutral pH conditions. Solubility modelling was conducted using the geochemical speciation model PHREEQC (Parkhurst and Appelo 1999) to simulate the removal of a portion of mass of aluminum from solution due to solubility controls. A correction factor of 5% was applied to the aluminum concentration predicted for the contact water (i.e., it is assumed that only 5% of the aluminum remains dissolved and the remaining mass precipitates from solution).

According to the Conceptual Closure and Reclamation Plan, approximately 25% of the total MRA surface area (i.e. the flat surfaces on the benches) will be covered with a layer of overburden and vegetated during the closure phase. Areas outside of the targeted areas for vegetation will also become naturally vegetated over the



course of several decades post-closure as a result of spreading of some rogue species. During stage I of the post-closure phase (between the closure phase and 50 to 80 years post-closure), it is assumed that 100% of the water that lands on the surface of the MRA becomes contact water. As vegetation becomes established over the course of decades during the post-closure phase, precipitation that lands on the vegetated surface of the MRA will be subject to increased evapotranspiration with the remaining surplus assumed to infiltrate into the MRA subsurface. The mine rock source term in water quality model for only stage II of the post-closure phase (>50 to 80 years after closure) assumes that about 25% of the precipitation will be lost back to the atmosphere through evapotranspiration on an average annual basis. It is assumed that the remaining 75% of the water that lands on the MRA becomes contact water, either through runoff or subsurface flow, on an average annual basis.

Once the open pit is filled, runoff from the MRA will report to the receiving environment. It is assumed that the following lakes will receive runoff and seepage load from the MRA during post-closure phase stage II: Côté Lake, Chester Lake, Three Duck Lakes (upper-middle basin and lower basin), Delaney Lake and the Mollie River.

For the mass loading rates only during post-closure stage II (> 50 to 80 years after closure), a correction factor was applied to account for decreased reactivity over the course of several decades. Using arsenic as an analog, concentrations in the 14 humidity cells decreased between 9 and 60% over weeks 1 through 34. It is assumed that it is reasonable to expect loading rates from the MRA to decrease 50% over 5 to 8 decades between the operations phase and the post-closure phase stage II. As such, a correction factor of 0.5 was applied to the lithology-specific loading rates in the post-closure phase stage II model to account for the decreased reactivity after greater than 50 to 80 years of weathering of non-acid generating and relatively inert mine rock.

2.5.3.2 Low-grade Stockpile Contact Water

At the time of modelling, no testing program had been conducted to characterize the geochemical composition of what is expected to be low-grade ore at the Project. For the purposes of modelling, it is assumed that the loading rates taken from the humidity cell tests are representative of the range of geochemical characteristics expected to be encountered in the low-grade ore. As with the mine rock, contact water loading rates from the low-grade stockpile were derived from estimates of rock tonnage and the results of humidity cell testing. The total tonnage assumed for the ore stockpile was 260,737,000 tonnes (G Mining 2013, pers. comm.).

2.5.3.3 Open Pit Wall Rock Contact Water

Rock exposed in the reactive zone (i.e., outer fractured shell due to blasting of the mine rock) of the open pit is subject to physical and chemical weathering over time. For the purposes of modelling, it is assumed that the thickness of this reactive zone is 1 m. The reactive thickness was multiplied by the surface area of the open pit (1,924,856 m²) to determine the reactive volume. The reactive volume is then multiplied by an assumed bulk density representative of diorite (2,800 kg/m³) (EduMine 2013) to determine the reactive pit mass. Furthermore, similar to the scaling up of the humidity cell results for the mine rock, the loading rate for the open pit wall rock was adjusted using a factor of 0.1 to account for differences in reactive surface area.

2.5.3.4 Pit Lake Water Quality

The post-closure phase stage II model was run to predict the water quality of Côté Lake (the fully flooded open pit), assuming that overflow from Côté Lake discharges to the upper basin of Three Duck Lakes. The model



assumes variable water quality at different depths within the pit (i.e., chemical stratification), with the top one-third (188 m) of the pit being well-mixed and containing of 10% of the total mass load. The bottom two-thirds (376 m) is assumed to not mix with the shallow pit water (i.e., no turnover) and is assumed to contain 90% of the total mass load. Allocating a relatively lower mass load in the shallow water versus the deeper zones is a reasonable assumption, based on observations of chemical stratification in other deep pit lakes. The overflow from Côté Lake to Three Duck Lakes is assumed to have the water quality of the upper one-third of Côté Lake.

The total mass in Côté Lake was calculated based on the open pit sump water quality calculated during the operations phase; this is considered to be a conservative assumption because, as the open pit fills, the relative contribution from the pit wall runoff to the total load to the open pit will decrease and the contribution from natural runoff will increase.

2.5.4 Residual Explosives Inputs

Explosive agents, including ammonium nitrate/fuel oil (ANFO) and emulsion will be used during mining of the open pit. The detonation of explosives, and the consumption of its agents, is not 100% efficient. The residual undetonated explosives present in the mine rock, low grade ore and open pit are soluble and therefore a source of nitrate and ammonia in site drainage.

Data was provided by G Mining on the explosives to be used for blasting, including the Material Safety Data Sheet (MSDS) for the expected emulsion explosive and estimates of usage rates per tonne of mine rock (G Mining 2013, pers. comm.). The potential influence of nitrate and ammonia mass release associated with mining activities is estimated based on the ultimate tonnage of mine rock and projected explosive use rate for the Project. The composition of the two components is generally estimated as follows, and presented in detail in Table 8:

- ANFO: 94% NH₄NO₃, 6% Fuel Oil (assumed composition based on explosives typically used for mining operations); and
- Emulsion: 80% NH₄NO₃, 6% H₂O, 6% Fuel Oil, 6% Mineral Oil, 1% Thiourea and 1% acetic acid (assumed composition based on the Material Safety Data Sheet provided by G Mining [Orica 2011]).

Table 8: Explosives Composition and Nitrogen Species Weight Proportions

Component	Parameter	Molar Mass ⁽¹⁾	Proportion of Nitrogen ⁽²⁾	ANFO ⁽³⁾		Emulsion (non-aluminized) ⁽⁴⁾	
				Composition	Weight Proportion ⁽⁵⁾	Composition	Weight Proportion ⁽⁵⁾
NH ₄ NO ₃	NH ₄	18.05	0.78	94%	0.21	80%	0.18
	NO ₃	61.98	0.23		0.73		0.62
NaNO ₃	Na	22.99	-	-	-	-	-
	NO ₃	61.98	0.23		-		-
Water	H ₂ O	18.01	-	-	-	6%	-
Microballoons	-	-	-	-	-	-	-



CÔTÉ GOLD PROJECT WATER QUALITY MODELLING REPORT

Component	Parameter	Molar Mass ⁽¹⁾	Proportion of Nitrogen ⁽²⁾	ANFO ⁽³⁾		Emulsion (non-aluminized) ⁽⁴⁾	
				Composition	Weight Proportion ⁽⁵⁾	Composition	Weight Proportion ⁽⁵⁾
(glass)							
Fuel Oil	-	-	-	6%	-	6%	-
Mineral Oil	-	-	-	-	-	6%	-
Thiourea ⁽⁶⁾	CS	44.08	-	-	-	1%	-
	N ₂ H ₄	32.06	0.87				0.0042
Acetic Acid	C ₂ H ₄ O ₂	60.05	-	-	-	1%	-
Aluminum	Al	26.98	-	-	-	-	-

Notes:

A dash "-" indicates that this data is not applicable.

(1) Units of molar mass = g/mol

(2) Assumed proportion of nitrogen in NH₄, NO₃ and N₂H₄.

(3) Assumed composition of ANFO (Ammonium Nitrate / Fuel Oil) based on explosives typically used for mining operations.

(4) Assumed composition of emulsion explosive product is based on Material Safety Data Sheet for Fortis™ Extra 70, 80, 100 & ANE (Canada).

(5) Assumed weight proportion of NH₄ and NO₃ in the components NH₄NO₃ and NaNO₃.

(6) Thiourea was disregarded in the mass loading calculations, as the relative proportion is small relative to the ammonium and nitrate proportions; it is presented here for completeness.

An explosives usage rate (powder factor) of 0.30 kg per tonne mine rock and ore is assumed for the purposes of water quality modelling, assuming 70% ANFO use and 30% emulsion. The fraction of explosive residues remaining after blasting (i.e., "waste rate") is assumed to be 5%. The residual mass of nitrogen species by rock type is presented in Table 9.

Table 9: Residual Mass of Nitrogen Species

Parameter	Units	Value
Mine Rock Tonnages⁽¹⁾		
Total Mine Rock Tonnage	tonnes	915,381,000
Ore Tonnage	tonnes	260,737,000
Waste Rock Tonnage	tonnes	654,644,000
Explosives Usage and Waste		
Usage Rate ⁽²⁾	kg per tonne	0.3
Explosives Mass Required to Blast Ore	kg	78,221,100
Explosives Mass Required to Blast Waste Rock	kg	196,393,200
Waste Rate ⁽²⁾	%	5%



Parameter	Units	Value
Undetonated Explosives - Ore	kg	3,911,055
Undetonated Explosives - Waste Rock	kg	9,819,660
Ammonium Nitrate / Fuel Oil (ANFO)		
Proportion of Total Explosives	%	70%
Weight Proportion - Ammonium (NH ₄)	-	0.21
Weight Proportion - Nitrate (NO ₃)	-	0.73
Emulsion (Non-aluminized)		
Proportion of Total Explosives	%	30%
Weight Proportion - Ammonium (NH ₄)	-	0.18
Weight Proportion - Nitrate (NO ₃)	-	0.62
Total Residual Mass of Nitrogen Species by Rock Type		
Ore Rock		
Ammonium (NH ₄)	kg	792,127
Nitrate (NO ₃)	kg	2,720,001
Waste Rock		
Ammonium (NH ₄)	kg	1,988,828
Nitrate (NO ₃)	kg	6,829,227

Notes:

- (1) Waste rock tonnages provided by G Mining 2013 (pers. comm.).
- (2) Usage rate and waste rate provided by G Mining 2013 (pers. comm.).

Explosives information was used to estimate loading rates of nitrate and total ammonia due to dissolution of residual blasting agents in the mine rock and within the open pit.

Half of the explosives waste is assumed to be contained within the MRA and low-grade stockpile, split based on the relative tonnages of each of the two (with the tonnage of waste rock and ore being 71.5% and 28.5% of the total mine rock tonnage, respectively). The other half is assumed to remain within the open pit. Loading rates were assigned assuming that 1% of the nitrogen is available per year, which is consistent with observations at mine site where studies have been completed on water quality effects due to residual explosive loading rates associated with mine rock (Ferguson and Leask 1988).

2.5.5 Tailings Management Facility Runoff and Seepage

2.5.5.1 Loading Rate Assumptions

Tailings exposed in the reactive zone (i.e., the exposed beach area) of the TMF are subject to physical and chemical weathering over time. For the purposes of modelling, it is conservatively assumed that the thickness of the reactive zone of the beach tailings is 1 m; that is, the mass of tailings that releases a mass load to surface runoff is conservatively assumed to be 1 m x tailings surface area [m²] x tailings bulk density [kg/m³]. The reason to consider a depth of up to 1 m is to account for mass loading due to seepage entering the reclaim pond within the TMF. In areas where the water table is deeper, assuming that a zone up to 1 m deep provides mass load to the surface runoff is overly conservative.



Currently, there are no data on the geochemistry of the tailings. For the purposes of the water quality modelling, the tailings geochemistry, including metal leaching characteristics, are assumed to be similar to the mine rock. As such, the input chemistry of the tailings runoff and seepage is assigned based on the lithology-specific loading rates, weighted by tonnage (as described in Section 2.5.3.1).

A humidity cell adjustment factor of 0.1 was applied to assist with the upscaling of the loading rates from the laboratory-scale humidity cells to the full-scale TMF. The adjustment factor accounts for differences in rates of reactions that are exhibited due to the different conditions that a humidity cell test charge is subjected (in order to facilitate the advancement of the weathering reactions) versus the on-site ambient conditions in the field. In the field, the tailings will be subjected to sub-zero temperatures during winter months and even during some early-spring and late-fall months, and temperatures cooler than laboratory conditions almost all year. The differences in temperature will result in considerably lower weathering rates in the field.

It is assumed that the mass of copper in the seepage from the TMF will be reduced through the process of adsorption onto solids in the subsurface, as the seepage flows from the TMF to the seepage collection system. It is reasonable and conservative to assume that 25% of the mass of copper is adsorbed in the subsurface. Lund et al. (2008) carried out surface complexation modelling of copper (II) adsorption over a range of hydrous ferric oxide (HFO) and kaolinite mixture proportions, pH, ionic strength and sorbate/sorbent ratios. At neutral pH, the adsorption of copper on HFO and kaolinite was determined to be nearly 100%. This assumption is reasonable given that the model does not account for precipitation and co-precipitation mechanisms within, and downgradient of, the tailings.

2.5.6 Process Water Quality

Ore beneficiation for the Project includes the use of cyanidation to extract the gold, which results in cyanide-bearing process water. The process water containing cyanide will report to a cyanide destruction circuit prior to being discharged to the TMF. However, some residual cyanide, by-products of the cyanide destruction process, and other metals, will remain in the process water that is discharged into the TMF. The process water in the TMF will make-up part of the water in the reclaim pond. Furthermore, the process water will in part become retained in the tailings pore space, a portion of which may migrate out of the TMF as seepage. The chemistry of the process water will therefore have an effect on the water quality of the reclaim pond and seepage that is collected in the TDSPs.

No information exists as to the specific quality of the process water that will be produced by the processing plant; as such, assumed concentrations were derived from typical process water compositions observed at analogous sites and using professional judgment (with the exception of cyanide species, as discussed below). Table 10 presents the assumed process water concentrations.

Table 10: Assumed Process Water Quality

Parameter	Concentration (mg/L)
Aluminum	0.05
Ammonia (Total)	20
Ammonia (Un-ionized) ⁽¹⁾	N/A
Antimony	0.001



Parameter	Concentration (mg/L)
Arsenic	0.001
Barium	0.05
Boron	0.00001
Cadmium	0.000001
Calcium	50
Chloride	25
Cobalt	0.001
Copper	0.1
Cyanide (Total) ⁽²⁾	2
Cyanide (Free) ⁽³⁾	0.5
Iron	0.5
Lead	0.0001
Magnesium	25
Manganese	0.05
Molybdenum	0.05
Nickel	0.01
Nitrate ⁽⁴⁾	N/A
Phosphorus (Total)	0.01
Potassium	25
Sodium	100
Strontium	0.1
Sulphate	250
Uranium	0.005
Vanadium	0.0001
Zinc	0.002

Notes:

mg/L - milligram per litre

- (1) Cyanide will be treated within the cyanide destruct circuit to a concentration of 2 mg/L, or below; as such, an assumed total cyanide concentration of 2 mg/L was assigned to the process water quality model input.
- (2) Un-ionized ammonia is calculated within the model using average monthly field pH and field temperature.
- (3) Free cyanide is assumed to comprise 25 % of total cyanide.
- (4) There is assumed not to be a source of nitrate to the process water.

The process water undergoes a treatment process to destroy cyanide via an SO₂/air process. The concentration of cyanide in the water exiting the processing plant, which is routed to the destruct circuit, is anticipated to be approximately 50 mg/L (IAMGOLD 2013, pers. comm.). The cyanide will be treated within the cyanide destruct circuit to a concentration of 2 mg/L, or below; as such, the assumed total cyanide concentration of 2 mg/L was assigned to the process water quality model input.



The destruction of cyanide will create ammonia as a by-product. Based on total ammonia observed in tailings ponds at analogous sites, the cyanide destruction process is estimated to generate total ammonia concentrations in the process water of approximately 20 mg/L.

Natural degradation of cyanide is expected to occur within the TMF pond, and depending on the speciation of cyanide, occurs at variable rates. The speciation of total cyanide was estimated using the geochemical speciation model PHREEQC and then generalized into three basic species types: free cyanide, cyanide weakly complexed with metals, and cyanide strongly complexed with metals. The estimated relative proportions of each of the cyanide species are as follows:

- 1) Free cyanide (assumed to comprise 25% of total cyanide).
- 2) Weakly complexed metallo-cyanides (assumed to comprise 70 % of total cyanide).
- 3) Strongly complexed metallo-cyanides (assumed to comprise 5% of total cyanide).

Strongly complexed metallo-cyanides degrade via photolysis reactions to produce free cyanide. Weakly complexed metallo-cyanides degrade via hydrolysis reactions to produce free cyanide. Free cyanide degrades via volatilization. Monthly rates of reactions for photolysis, hydrolysis and volatilization incorporated into the model were inferred from rate constants presented in Smith (1994), Simovic and Snodgrass (1989) and Bolz and Mudder (2000). The literature rate constants were developed under ideal degradation conditions, and as such, were assumed to be representative of summer conditions, which are favourable for cyanide degradation due to the higher temperatures and greater number of daylight hours during these months. It is assumed that in winter, when temperatures are below freezing and the amount of sunlight is decreased, the rates of photolysis and volatilization will be zero. It is assumed that some degree of hydrolysis will persist throughout the winter months; as such, this rate is not assumed to be zero but rather one-third of the maximum rate. For the spring and fall, the rates of reaction for photolysis, hydrolysis and volatilization were assigned an intermediate value between the assumed minimum and maximum rate constants.

Table 11 presents the assumed monthly rate constants applied in the model.

Table 11: Assumed Monthly Rate Constants for Cyanide Degradation

Month	Rate Constant			
	Photolysis (hr ⁻¹)	Hydrolysis of metallo-cyanides (hr ⁻¹)	Volatilization (cm/hr)	Hydrolysis of HCN (month ⁻¹)
January	0	0.001	0	0.04
February	0	0.001	0	
March	0	0.001	0	
April	3.00E-05	0.001	0.03	
May	1.00E-04	0.002	0.03	
June	2.00E-04	0.002	0.035	
July	2.00E-04	0.003	0.04	
August	2.00E-04	0.003	0.04	
September	1.00E-04	0.002	0.035	



Month	Rate Constant			
	Photolysis (hr ⁻¹)	Hydrolysis of metallo-cyanides (hr ⁻¹)	Volatilization (cm/hr)	Hydrolysis of HCN (month ⁻¹)
October	1.00E-04	0.002	0.03	
November	3.00E-05	0.001	0.03	
December	0.00E+00	0.001	0	

Notes:
cm/hr – centimetre per hour

2.6 Key Model Limitations and Assumptions

Detailed assumptions that govern the model are presented throughout the text. A number of limitations and assumptions inherent to the model in general are described below. Some general limitations to the model include:

- Changes to operational Project or site conditions – The Project Description (see EIS Report) and inputs as discussed in this document are the basis for the model. Changes in Project scope or design details will necessarily result in changes to water quality predictions. The model is limited in its ability to forecast operational conditions due to the dynamic nature of developments in a project of this nature, and potential short-term changes to site conditions; as such, the purpose of the water quality modelling is to assist with planning at the EA stage of the Project.
- Changes to post-closure site conditions – Several assumptions were made with respect to the water quality and flows at the Project site during the post-closure phase (stage I and stage II). These assumptions are based on the conceptual closure plan (AMEC 2013a) and may change with changes to operational Project or site conditions. The water quality inputs applied within the post-closure phase (stage I and stage II) models are based on existing monitoring and laboratory data and may change as operational monitoring is conducted.
- System complexity – Care was taken to incorporate known processes, as understood, during model development. However, it should be noted that, in natural systems and complex man-made systems, observed conditions will vary with respect to predicted conditions.
- Limitation of baseline data – Certain parameters (e.g., nitrate and total phosphorus) have only been sampled occasionally as part of the baseline water quality monitoring program described in Section 2.4.1, and therefore a limited data set is available for statistical analysis and comparison. Certain lakes (e.g., Neville Lake, Delaney Lake, Dividing Lake and Mesomikenda Lake) have only been sampled since May 2013 and only one round of water quality data was available for statistical analysis and comparison. The reported laboratory detection limits for certain parameters (e.g., antimony, cadmium, and total phosphorus) were lowered in 2013 in order to provide a more accurate comparison to water quality guidelines, and therefore a limited data set is available for statistical analysis and comparison for some solutes.
- Screening-level static testing was not conducted on the rock samples selected for humidity cell testing and, as such, there is some uncertainty regarding the suitability (or the representativeness) of the existing humidity cell data to predict the drainage characteristics of the mine rock and pit walls. For the purposes of



modelling, it is assumed that the available humidity cell test data is representative of the range of geochemical characteristics present in the mine rock, pit walls, and low-grade ore.

- No geochemistry data is available for the Project-specific tailings, as geochemical test work has not been completed on tailings samples. For the purposes of modelling, it is assumed that the available humidity cell test data collected from the 14 rock samples is representative of the range of geochemical characteristics present in the tailings.

The general assumptions associated with the model include:

- The water quality model concept for the operations phase is based on the Project configuration at the end of mine life and therefore predicts water quality of the Project site components using the ultimate extents of the open pit, MRA, low-grade stockpile and TMF. This is considered to be a conservative approach as the loading rates that are used to predict contact water quality are calculated using the greatest tonnages of rock in the MRA and low-grade stockpile, and largest surface areas exposed during the life of mine in the open pit and TMF. Furthermore, it is assumed that the MRA and low-grade stockpile will not be progressively rehabilitated and direct precipitation will be allowed to infiltrate and interact across the full footprint of mine rock, low-grade ore and tailings.
- It is unknown what type of material is to be used for construction of the watercourse realignments and open pit perimeter dams. For the purposes of the model, these structures are assumed to consist of geochemically suitable materials (i.e., drainage from construction materials has near-neutral pH and concentrations of metals below water quality guidelines).
- Because of challenges in modelling the TSS concentrations, the water quality modelling results are represented as dissolved concentrations rather than total concentrations. It should be noted, however, that total concentrations at specific points of interest could be higher than the results presented herein, depending on site-specific hydrological conditions and controls (i.e., TSS load).

3.0 MODEL RESULTS

The water quality model predictions presented herein include statistical calculations of the median and absolute maximum parameter concentrations for each surface water body, as well as the percentage of days that the concentration is above aquatic and human health criteria as defined in Section 3.1.2. These comparisons were made in support of the predictions of effect in the Aquatic Biology and Human and Terrestrial Ecological Health Risk Assessment TSDs. For the purposes of the predictions of effects presented in the Water Quality TSD, the predicted monthly average concentrations were compared to effluent limits or water quality guidelines.

3.1 Development of Comparison Criteria

3.1.1 Effluent Discharge Limits

Effluent discharge from the site needs to meet the provincial metal mining sector effluent limits (as per Schedule 1 of Ontario Regulation 560/94 under the *Environmental Protection Act*) and the federal MMER limits (as per Schedule 4 of the MMER under the *Fisheries Act*, Government of Canada 2002). For the purposes of comparison and evaluating the overall Project site water quality, the predicted water qualities of the Project site



components (i.e., open pit sump water, MRA seepage and runoff, low-grade stockpile seepage and runoff, mine water pond, TMF pond and polishing pond) are compared to the provincial and federal effluent limits.

3.1.2 Aquatic and Human Health Criteria

For the purposes of providing the results to the Aquatic Biology and Human and Terrestrial Ecological Health Risk Assessment teams, the predicted water quality results in the surface water receivers are compared to Aquatic Health Benchmarks and *Human Health Drinking Water Guidelines*.

The set of Aquatic Health Benchmarks were derived by using the most recent of the PWQO or CWQG, or the upper limit of background (95th percentile baseline concentration), whichever is higher for each parameter. If a PWQO or CWQG does not exist, the British Columbia *Water Quality Guidelines* (BCWQGs; British Columbia Ministry of the Environment 2013) were used for comparison. If a PWQO, CWQG or BCWQG does not exist for a given parameter, the 95th percentile baseline concentration was used as the Aquatic Health Benchmark. For parameters for which the criteria are dependent on pH and hardness, an assumed pH of 7 and hardness of 30 mg/L as CaCO₃ was applied.

The only Aquatic Health Benchmark that is not based on a PWQO, CWQG, BCWQG or 95th percentile concentration is the value for free cyanide, as a benchmark that is protective of aquatic life (non-salmonids) was used as the Aquatic Health Benchmark. The aquatic benchmark for free cyanide is 0.0098 mg/L, which was derived from the Water Environment Research Foundation (WERF) document titled: *Scientific Review of Cyanide Ecotoxicology and Evaluation of Ambient Water Quality Criteria* (WERF 2007); noting that this scientific source and the use of this aquatic benchmark for free cyanide has been accepted by regulatory agencies for use in a recent EA for a gold mine in Ontario.

A set of *Human Health Drinking Water Guidelines* were used for comparison by using the most recent of the ODWSs or CDWQGs; noting that for arsenic, the CDWQG was the more recent and more conservative guideline, and therefore used for the comparisons.

3.2 Model Results

Statistical summaries of median and absolute maximum parameter concentrations under average, dry and wet climatic conditions for the operations and post-closure phases are presented in tables located in Appendix A through C. The predicted concentrations in the Project site components (i.e., open pit sump, MRA seepage and runoff, low-grade stockpile seepage and runoff, mine water pond, TMF Pond, and polishing pond) are compared to current provincial and federal effluent discharge limits. The estimated concentrations in the surface water receivers are compared to the *Human Health Drinking Water Guidelines* and Aquatic Health Benchmarks. The tables in Appendix A through C were provided to the aquatic and human health teams as input data for the effects predictions that are presented in the Aquatic Biology and Human and Terrestrial Ecological Health Risk Assessment TSDs (Minnow 2013 and AMEC 2013d, respectively).

4.0 REPORT USE LIMITATIONS

This report has been prepared for use by IAMGOLD or its authorized agents. The factual information, descriptions, interpretations, comments, conclusions and electronic files contained herein are specific to the project described in this report or in the Water Quality TSD Report. Information used in this report should be



restricted to that specified in the scope of work unless otherwise mutually agreed upon by IAMGOLD and Golder. This report should be read in its entirety as some sections could be misinterpreted when taken individually or out-of-context. As mentioned previously, and noted in the reference section, this report relies on information provided in separate studies; these reports should be consulted in conjunction with reading this report. Golder is not responsible for use of this report and its content by a third party, and/or for its use for purposes other than those intended. As well, the final version of this report and its content supersedes any other text, opinion or preliminary version produced by Golder.

Golder is not responsible for any damages that may result from unpredictable or unknown conditions, from erroneous information provided by and/or obtained from sources other than Golder, and from ulterior changes in the site conditions unless Golder has been notified of any occurrence, activity, information or discovery, past or future, susceptible of modifying the conditions described herein, and have had the opportunity of revising its interpretations. In addition, Golder is not responsible for any decrease of a property's value or any failure to complete a transaction as a consequence of this report.

5.0 REFERENCES

- AMEC Earth & Environmental (AMEC). 2013a. Conceptual Closure Plan for the Côté Gold Project . July 18, 2013.
- AMEC. 2013b. Côté Gold Project, Geochemical Source Terms from Humidity Cell Testing. Technical Memorandum, April 16, 2013.
- AMEC. 2013c. Côté Gold Project , Project Description Pursuant to CEEA 2012. March 2013.
- AMEC. 2013d. Human and Ecological Health Risk Assessment Report, Côté Gold Project. TC121522.
- AMEC. 2013e. Geochemical Characterization Report, Côté Gold Project. TC121522.
- AMEC. 2013. Email communication. November 2013.
- British Columbia Ministry of the Environment. 2013. British Columbia Water Quality Guidelines (BCWQG). Available online at: http://www.env.gov.bc.ca/wat/wq/wq_guidelines.html. Accessed on December 2, 2013.
- Bolz, M. and Mudder, T. 2000. Modelling of Natural Cyanide Attenuation in Tailings Impoundments. Mineral and Metallurgical Processing, Vol. 17, No. 4, pp. 228-233, November 2000.
- Canadian Council of Ministers of the Environment. 2007. Canadian Water Quality Guidelines for the Protection of Aquatic Life Update 7.1 (December 2007). Available online at: http://www.ccme.ca/publications/ceqg_rcqe.html accessed July 31, 2013.
- Edumine. 2013. Average Specific Gravity of Various Rock Types. Available online at: <http://www.edumine.com/xtoolkit/tables/sgtables.htm>.
- Ferguson, K.D. and Leask, S.M. 1988. The Export of Nutrients from Surface Coal Mines. Regional Program Report 87-12. March 1988.
- G Mining Inc. 2013. Email communication. May 2013.



- Guerin, F., Nicholson, R., Smith, L. and Beckie, R. 2006. Nickel and Uranium Loading Estimates from a 20-year Old Waste Rock Pile: a Comparison of Field Estimates and Laboratory Leaching Tests. Paper presented at the 7th International Conference on Acid Rock Drainage (ICARD), March 26-30, 2006.
- Golder Associates Ltd. (Golder). 2013a. Côte Gold Project, Draft Environmental Assessment Report Technical Support Document: Water Quality, Version 1. Project Number 13-1192-0021.
- Golder. 2013b. Côte Gold Project, Draft Environmental Assessment Report Technical Support Document: Hydrology and Climate, Version 1. Project Number 13-1192-0021.
- Golder. 2013c. Côte Gold Project, Draft Environmental Assessment Report Technical Support Document: Hydrogeology, Version 1. Project Number 13-1192-0021.
- Golder. 2013d. Water Quality Baseline Report, Côte Gold Project. Project Number 13-1192-0021.
- Government of Canada. 2002. Metal Mining Effluent Regulations (SOR/2002-222), last amended on 2012-03-02. Available on-line at: <http://laws-lois.justice.gc.ca>, accessed July 31, 2013.
- Lund, T.J., Koretsky, C.M., Landry, C.L., Schaller, M.S. and Das, S. 2008. Surface complexation modelling of Cu(II) adsorption on mixtures of hydrous ferric oxide and kaolinite. *Geochemical Transactions*, 2008, 9:9.
- Marcoline, J., Smith, L. and Beckie, R. 2006. Water Migration in Covered Waste Rock, Investigations Using Deuterium as a Tracer. Paper presented at the 7th International Conference on Acid Rock Drainage (ICARD), March 26-30, 2006.
- Minnow. 2013. Côte Gold Aquatic Technical Support Document, Prepared for IAMGOLD Corporation, Gogama ON.
- Ontario Ministry of Environment and Energy. 1999. Provincial Water Quality Objectives, PIBS 3303E, Queen's Printer for Ontario. July 1994, reprinted February 1999.
- Nichol, C., Smith, L. and Beckie, R. 2005. Field-scale experiments of unsaturated flow and solute transport in a heterogeneous porous medium. *Water Resources Research*, Vol. 41, W05018, doi: 10.1029/2004WRF003035, 2005.
- Ontario Regulation 560/94. Municipal/Industrial Strategy for Abatement (MISA): Effluent Monitoring and Effluent Limits – Metal Mining Sector.
- Orica. 2011. Material Safety Data Sheet. 1541-Fortis TM Extra Series (Canada). Preparation Date: July 31, 2006. Revision Date: June 15, 2011.
- Parkhurst, D.L. and Appelo, C.A.J. 1999. User's guide to PHREEQC (version 2)--A computer program for speciation, batch-reaction, one-dimensional transport, and inverse geochemical calculations: U.S. Geological Survey Water-Resources Investigations Report 99-4259, 312 p.
- Smith, A. 1994. The geochemistry of cyanide in mill tailings. In: Jambor, J.L., Blowes, D.W. (Eds.), *Mineralogical Association of Canada Short Course Handbook, Environmental Geochemistry of Sulfide Mine-Wastes*, Chp. 11, pp. 293–332.



CÔTÉ GOLD PROJECT WATER QUALITY MODELLING REPORT

Simovic, L. and Snodgrass, W.J. 1989. Tailings Pond Design for Cyanide Control at Gold Mills using Natural Degradation. In: Gold Mining Effluent Treatment Seminar. March 22-23, 1989.

Water Environment Research Foundation. 2007. Scientific Review of Cyanide Ecotoxicology and Evaluation of Ambient Water Quality Criteria.



Report Signature Page

GOLDER ASSOCIATES LTD.

Natalie Korczak, M.Sc., P.Geo.
Hydrogeochemist

Mike Gunsinger, M.Sc., P.Geo.
Associate/Hydrogeochemist

NK/MRG/JP/ls

Golder, Golder Associates and the GA globe design are trademarks of Golder Associates Corporation.

n:\active\2013\1190 sudbury\1192\13-1192-0021 iamgold cote gold project timmins\3. water quality\reporting\modelling report\13-1192-0021r rpt 14nov10 revised iamgold water quality modelling.docx

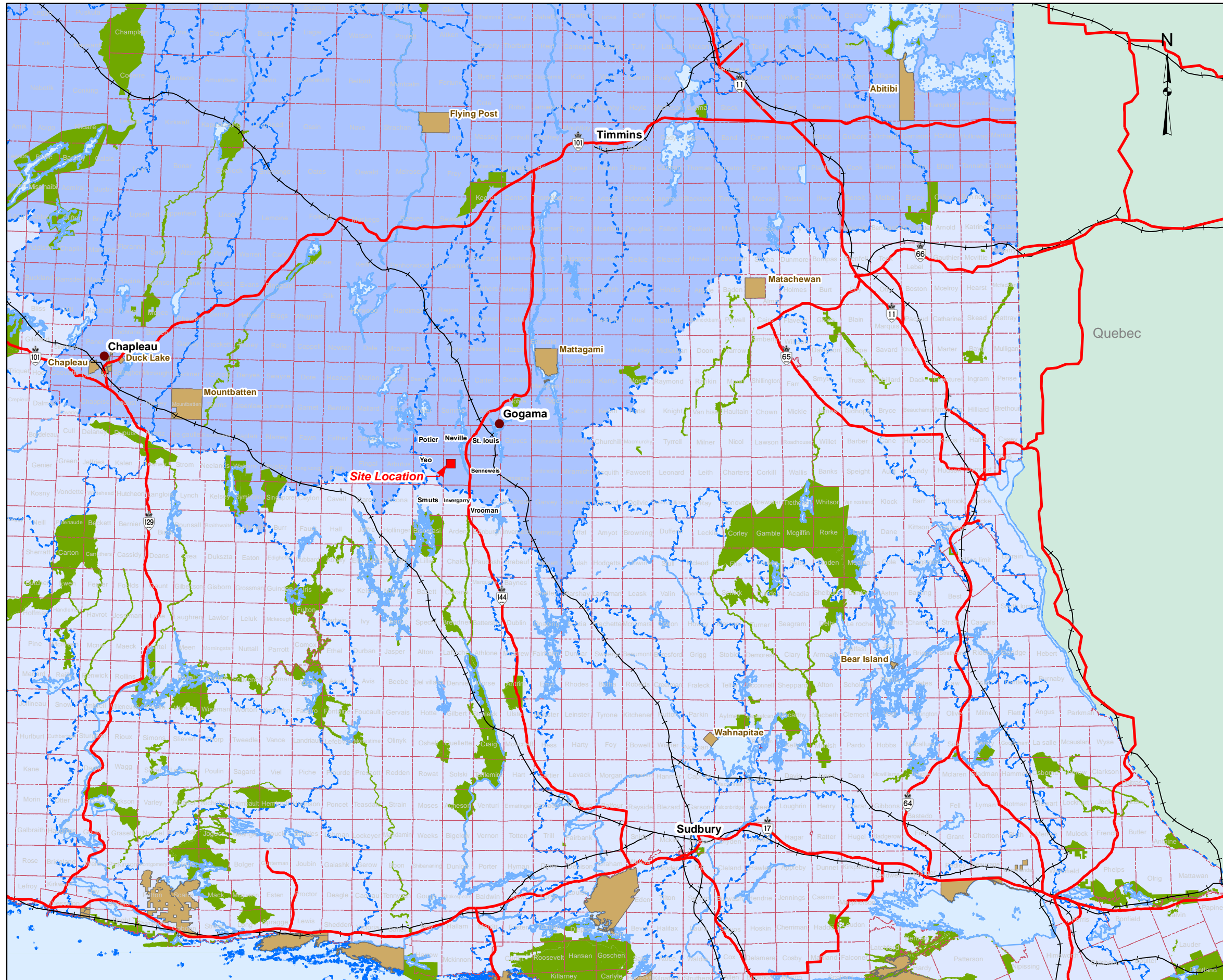

LEGEND

- Populated Places
- Major Roads
- Railway
- First Nations Communities
- Townships
- Provincial Park
- Primary Watersheds**
- Hudson Bay
- Great Lakes

REFERENCE

Base Data - MNR NRVIS, CANMAP v2008.4
 Produced by Golder Associates Ltd under licence from
 Ontario Ministry of Natural Resources, © Queens Printer 2012
 Projection: Transverse Mercator Datum: NAD 83 Coordinate System: UTM Zone 17

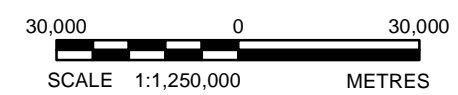

PROJECT		IAMGOLD CÔTÉ GOLD PROJECT	
TITLE		Project Location	
	PROJECT No.	13-1192-0021	SCALE AS SHOWN
	DESIGN	RRD Dec. 2012	REV. 0
	GIS	RRD Dec. 2013	FIGURE: 1
	CHECK	NK Dec. 2013	
REVIEW	MRG Dec. 2013		

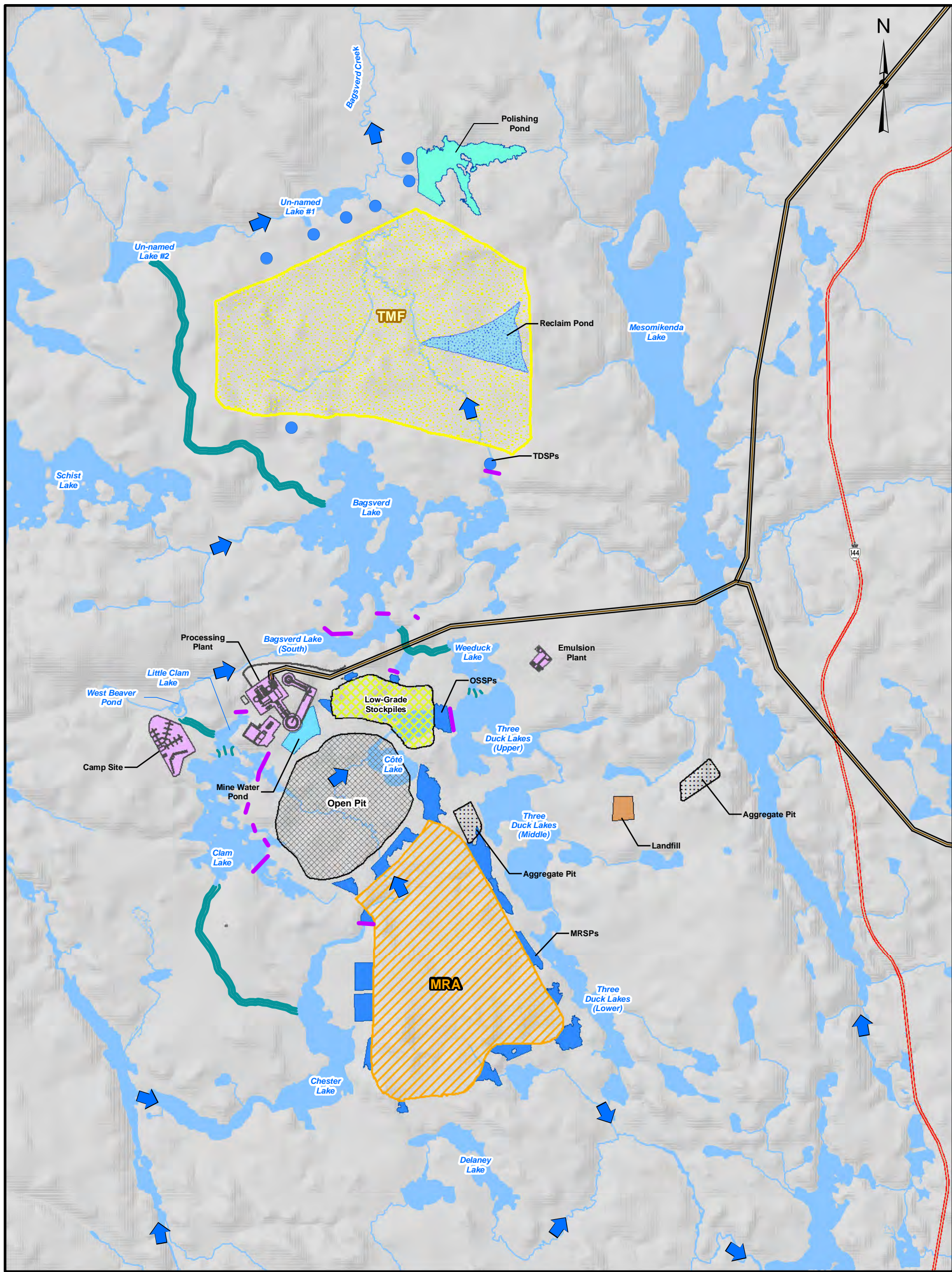

LEGEND

- Highway 144
- Realignment Dams
- Transmission Line
- Watercourse Realignment
- Low-Grade Stockpiles
- Mine Rock Area (MRA)
- Tailings Management Facility (TMF)
- Open Pit
- Polishing Pond
- Reclaim Pond
- Aggregate Pit
- Facilities
- Mine Water Pond
- Landfill
- Collection Ponds
- Waterbodies
- Creek / River
- Surface Water Flow Direction

NOTE:

Project site components are based on the ultimate extents of these facilities. (End of operations phase)

REFERENCE

Open Pit Shell provided by IAMGOLD, May 2013
 Base Data - MNR NRVIS, CANMAP v2008.4
 Produced by Golder Associates Ltd under licence from Ontario Ministry of Natural Resources,
 © Queens Printer 2013
 Projection: Transverse Mercator Datum: NAD 83 Coordinate System: UTM Zone 17



PROJECT
IAMGOLD CÔTÉ GOLD PROJECT

TITLE
 Site Plan



PROJECT No. 13-1192-0021			SCALE AS SHOWN	REV. 0
DESIGN	RRD	Feb. 2013	FIGURE: 2	
GIS	AL	Oct. 2013		
CHECK	NK	Dec. 2013		
REVIEW	MG	Dec. 2013		

INFLOW FROM SCHOU, PEBONISHEWI, BILLIE, OWATAWETNES, MOUSE, WOLF, VIVIAN, WHALSOM AND SOMME LAKES

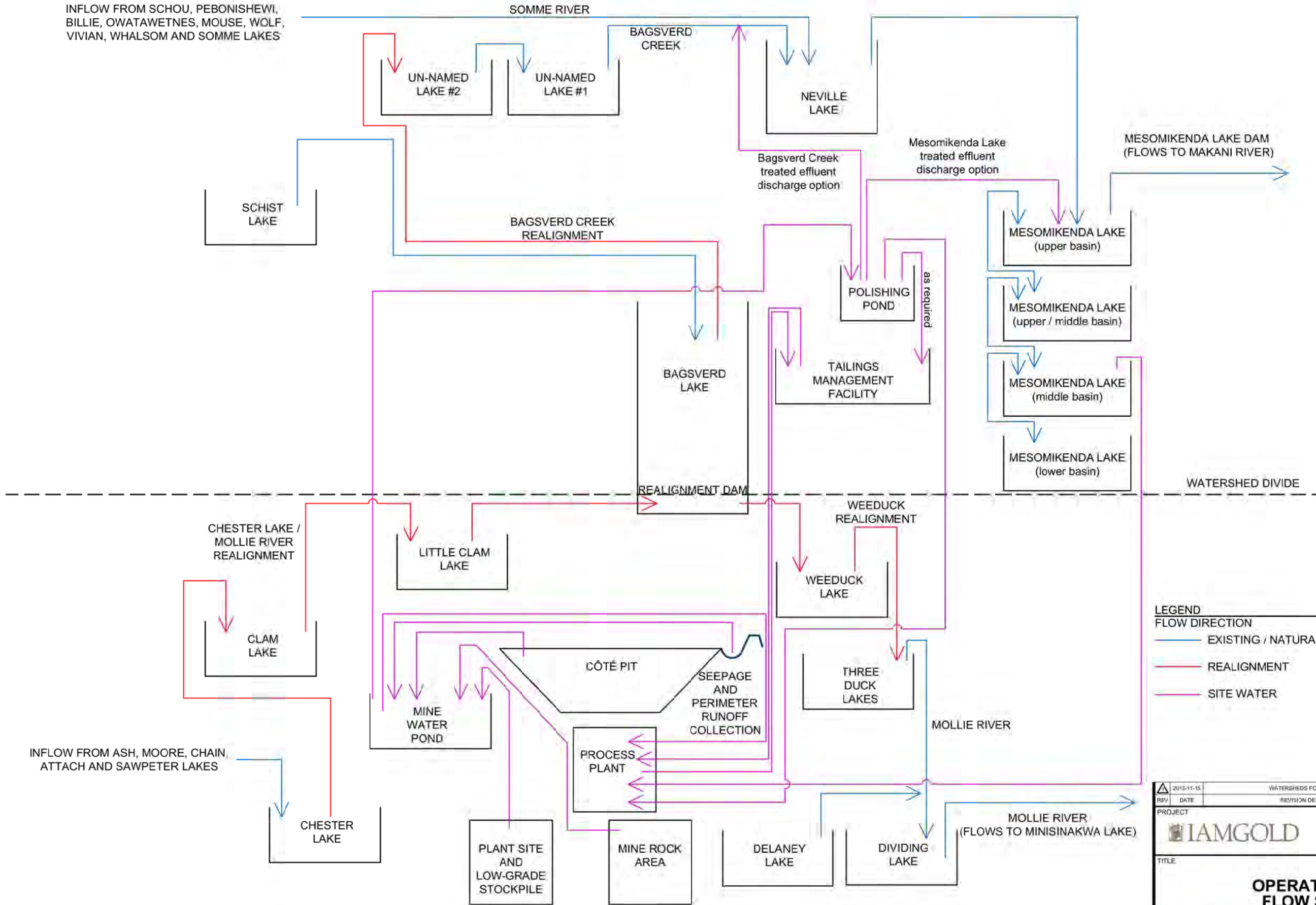

LEGEND
 FLOW DIRECTION
 — EXISTING / NATURAL
 — REALIGNMENT
 — SITE WATER

REV	DATE	WATERSHEDS FOR DISCUSSION	SK	JUL	XXX	XXX
		REVISION DESCRIPTION	DES	CADD	CHK	RWV

PROJECT
IAMGOLD CÔTÉ GOLD PROJECT

TITLE
OPERATIONS PHASE FLOW SCHEMATIC

PROJECT No.13-1192-0021.1000.****			FILE No.	1311920021A005
DESIGN	SK	2014-01-31	SCALE	NOT TO SCALE
CADD	JUL	2014-01-31	FIGURE	
CHECK	SK	2014-01-31		
REVIEW	JMP	2014-01-31		



I:\golder\pds\gold\Subsury\CAD-CIS\CAD\Projects\2013\13-1192-0021 IAMGold Code Gold\CIVIL_3D\1311920021A005.dwg | Layout: Figure 4-1 | Modified: jlebond 04/03/2014 11:16 AM | Plotter: jlebond 08/17/2014

INFLOW FROM SCHOU, PEBONISHEWI, BILLIE, OWATAWETNES, MOUSE, WOLF, VIVIAN, WHALSOM AND SOMME LAKES

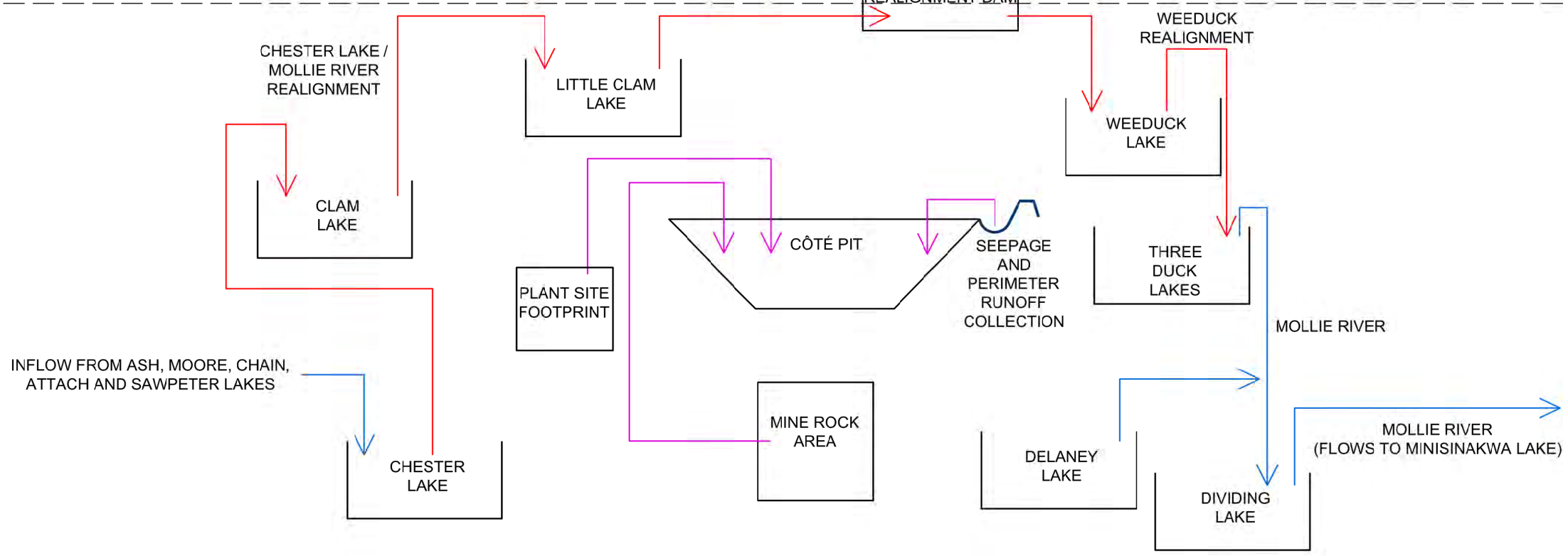
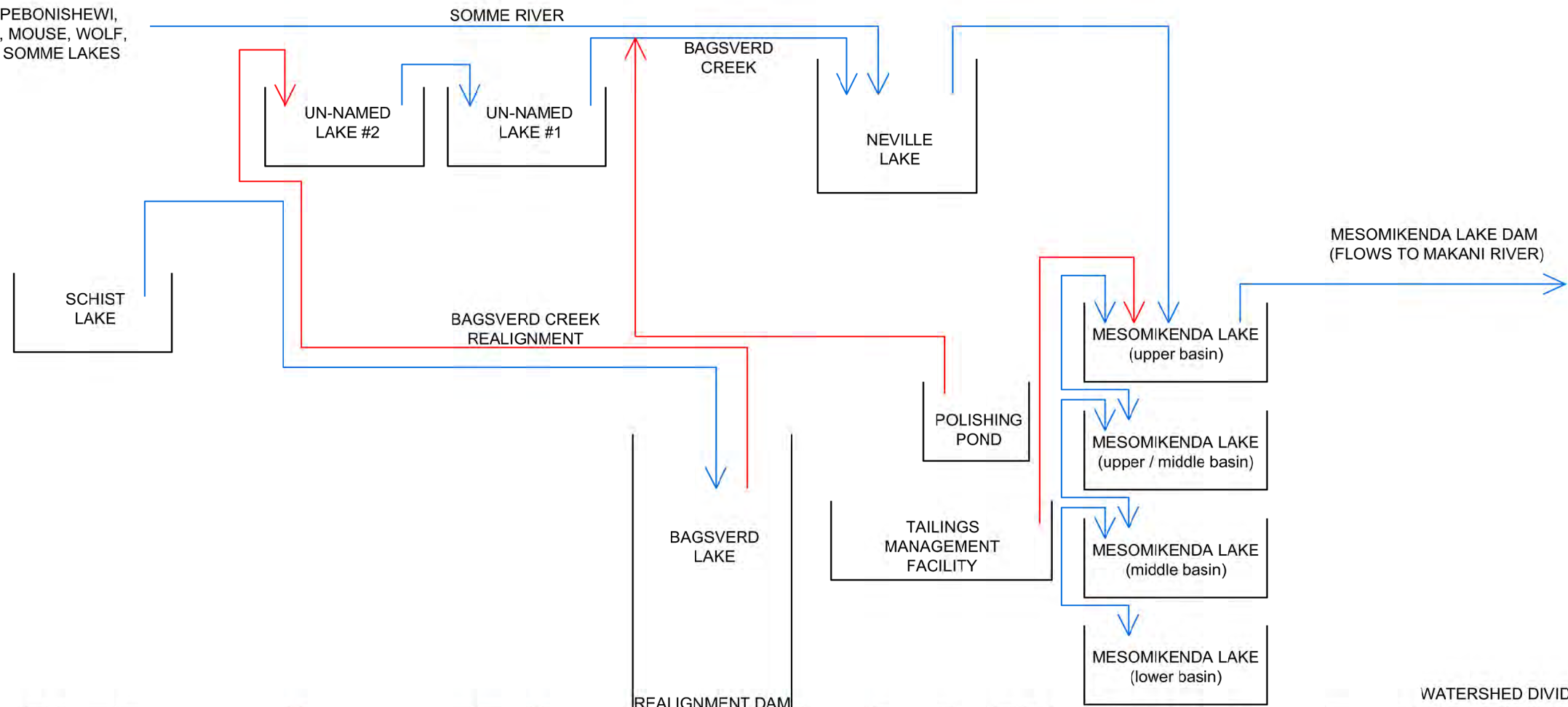

LEGEND
FLOW DIRECTION
 ——— EXISTING / NATURAL
 ——— REALIGNMENT
 ——— SITE WATER

INFLOW FROM ASH, MOORE, CHAIN, ATTACH AND SAWPETER LAKES

2013-11-15	WATERSHEDS FOR DISCUSSION	SK	JUL	XXX	XXX
REV	DATE	DES	CADD	CHK	RVV
PROJECT					
IAMGOLD		CÔTÉ GOLD PROJECT			
TITLE					
POST - CLOSURE PHASE STAGE I FLOW SCHEMATIC					
PROJECT No.13-1192-0021.1000.****		FILE No.		1311920021A005	
DESIGN	SK	2014-01-31	SCALE	NOT TO SCALE	
CADD	JUL	2014-01-31	FIGURE	4	
CHECK	SK	2014-01-31			
REVIEW	JMP	2014-01-31			

I:\goldcorp\suburb\CAD-CIS\CAD\Projects\2013\13-1192-0021 IAMGold Case Gold\CIVIL_3D\1311920021A005.dwg | Layout: Figure 4-2 | Modified: terecz 01/31/2014 8:58 AM | Plotted: terecz 01/31/2014



INFLOW FROM SCHOU, PEBONISHEWI, BILLIE, OWATAWETNES, MOUSE, WOLF, VIVIAN, WHALSOM AND SOMME LAKES

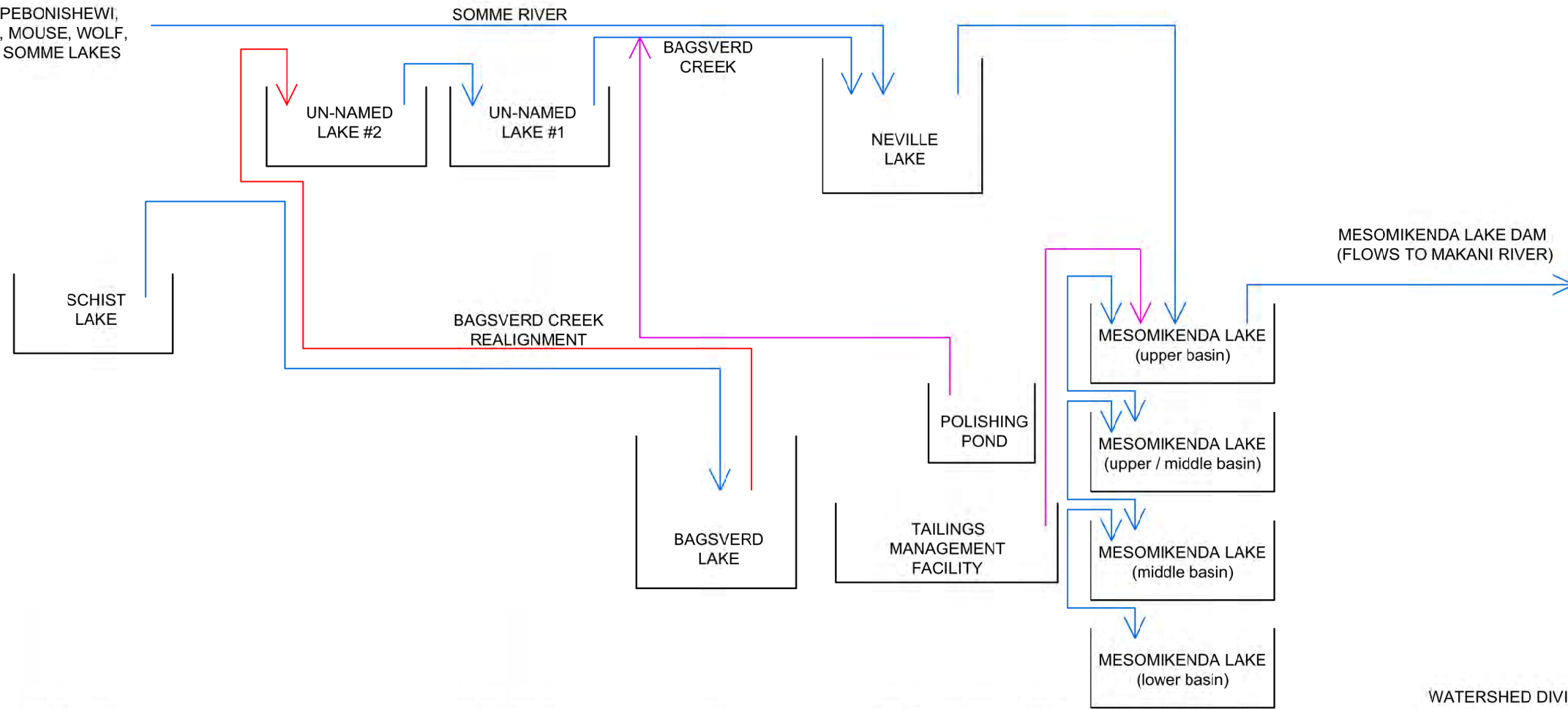

MESOMIKENDA LAKE DAM
(FLOWS TO MAKANI RIVER)

WATERSHED DIVIDE

INFLOW FROM ASH, MOORE, CHAIN, ATTACH AND SAWPETER LAKES

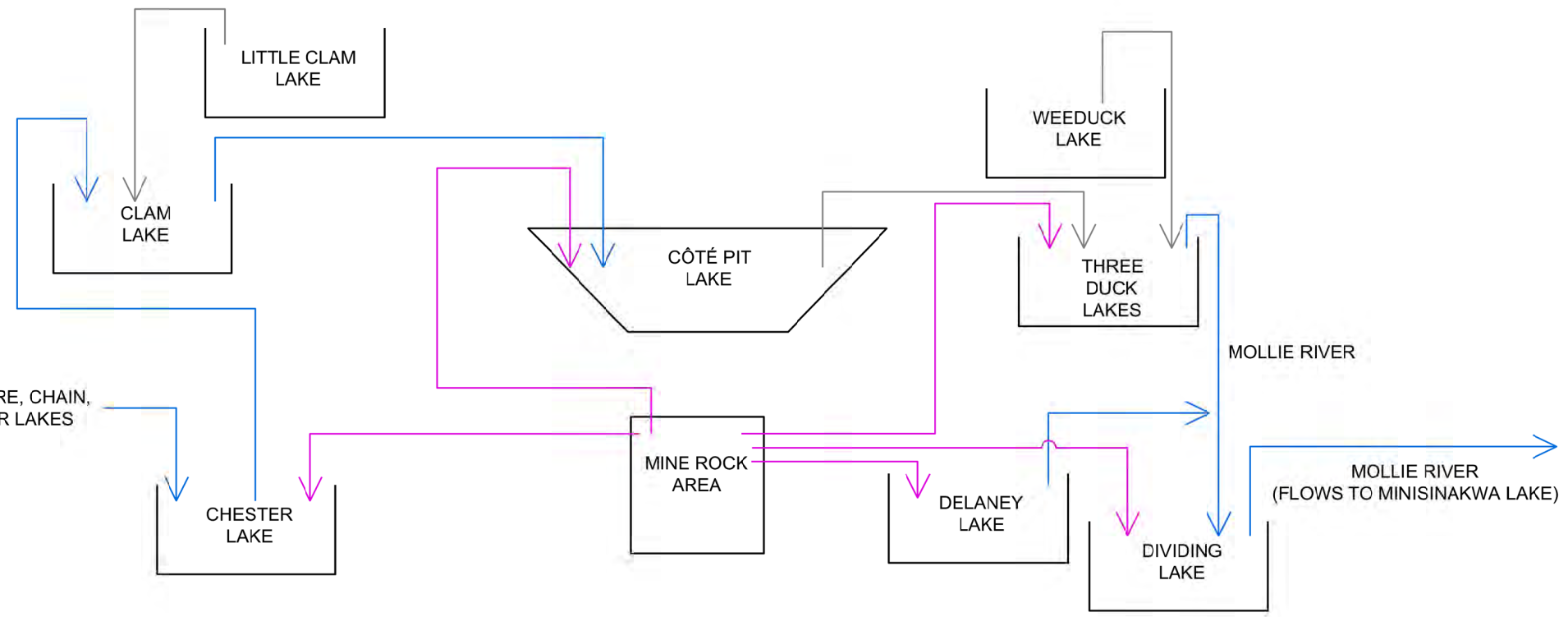

- LEGEND**
- FLOW DIRECTION
 - EXISTING / NATURAL
 - REALIGNMENT
 - SITE WATER
 - RESTORED OR REDIRECTED

REV	DATE	REVISION DESCRIPTION	DES	CADD	CHK	RVW
20	2013-11-15	WATERSHEDS FOR DISCUSSION	SK	JUL	XXX	XXX
PROJECT						
IAMGOLD			CÔTÉ GOLD PROJECT			
TITLE						
POST - CLOSURE PHASE STAGE II FLOW SCHEMATIC						
PROJECT No.13-1192-0021-1000 *****			FILE No.		1311920021A005	
DESIGN	SK	2014-01-31	SCALE		NOT TO SCALE	
CADD	JUL	2014-01-31	FIGURE		5	
CHECK	SK	2014-01-31				
REVIEW	JMP	2014-01-31				

I:\golder\golder\Subsidiary\CAD-GIS\CAD\Projects\2013\13-1192-0021 IAMGold Cote Gold\Civil_3D\1311920021A005.dwg | Layout: Figure 4-3 | Modified: terecz 01/13/2014 8:58 AM | Plotted: terecz 01/13/2014

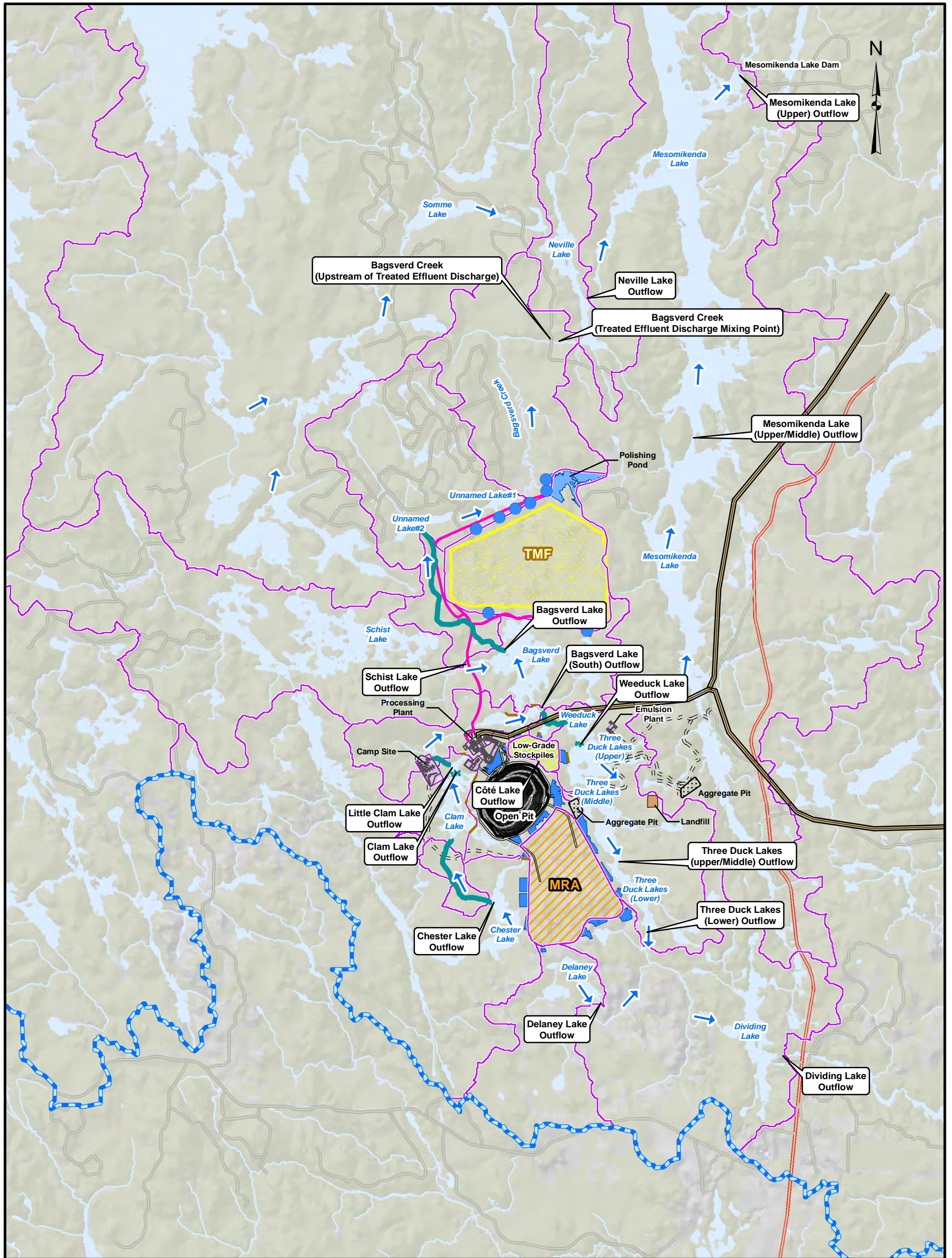

LEGEND

- Transmission Line
- Watercourse Realignment
- Tailings and Reclaim Pipeline
- Realignment Dams
- Aggregate Pit
- Landfill
- Facilities
- Arctic/Atlantic Watershed Divide
- Infrastructure Watersheds
- Pit Limit
- Polishing Pond
- Ore Stockpile
- Tailings Management Facility (TMF)
- Mine Rock Area (MRA)
- Regional Roads
- Highway 144
- Site Access Roads
- Pit Roads
- Collection Ponds
- Waterbodies
- Creek/River
- Wooded Areas
- Surface Water Flow Direction

REFERENCE

IAMGOLD Open Pit, May 2013.
 Base Data - MNR NRVIS, CANMAP v2008.4
 Produced by Golder Associates Ltd under licence from Ontario Ministry of Natural Resources,
 © Queens Printer 2013
 Projection: Transverse Mercator Datum: NAD 83 Coordinate System: UTM Zone 17

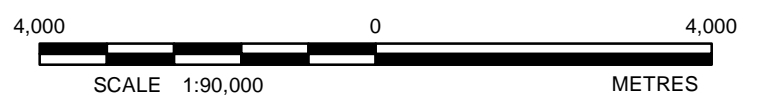

PROJECT		IAMGOLD CÔTÉ GOLD PROJECT	
TITLE			
Prediction of Water Quality Effects Locations			
PROJECT No. 13-1192-0021		SCALE AS SHOWN	REV. 0
DESIGN	RRD	Feb. 2013	FIGURE: 6
GIS	RRD	Dec. 2013	
CHECK	NK	Jan. 2014	
REVIEW	MRG	Jan. 2014	



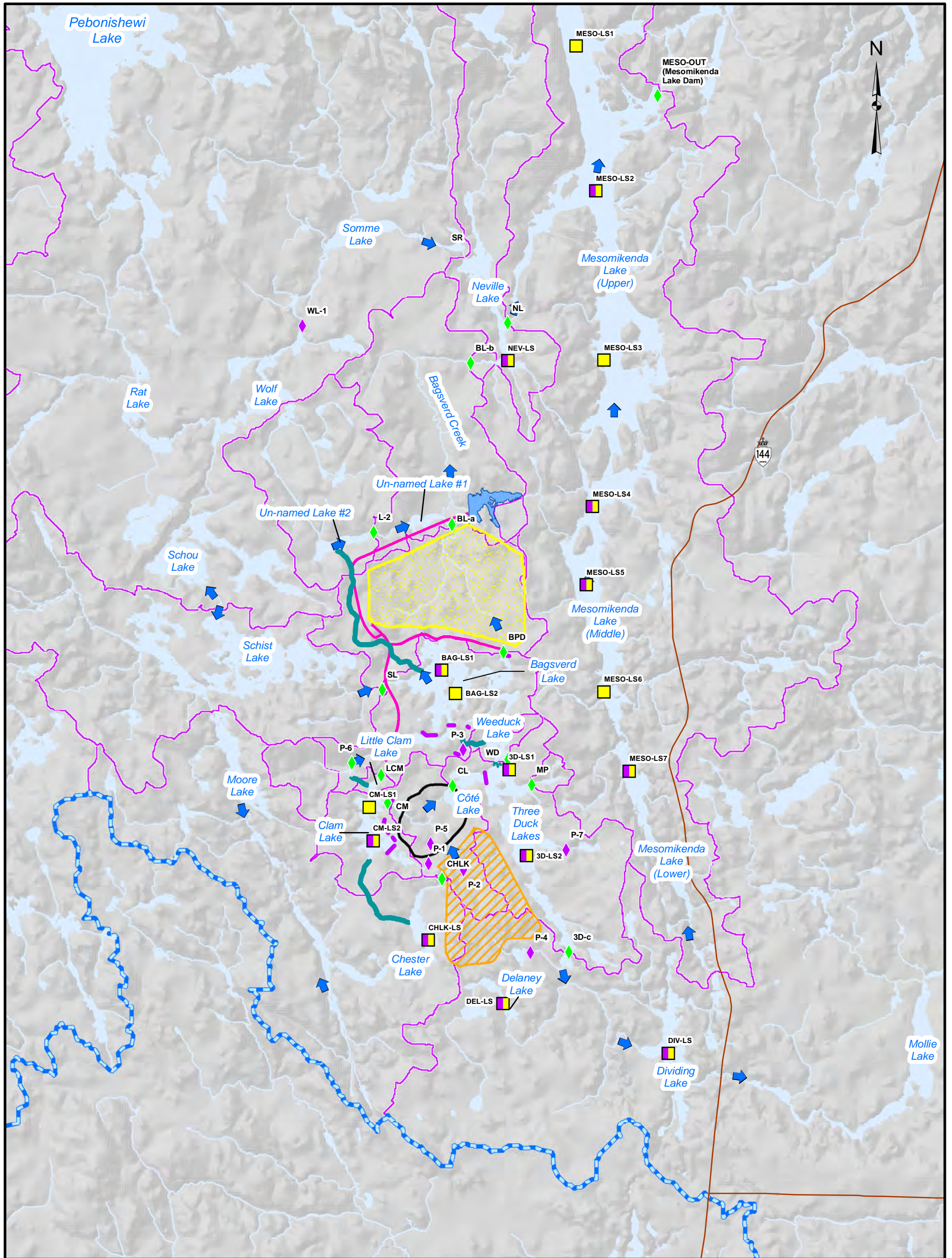

LEGEND

- Water Column Profile Location (with sample)
- Water Column Profile Location
- Watercourse Quality Monitoring Location (Monthly)
- Watercourse Quality Monitoring Location (Quarterly)
- Flow Direction
- Major Roads
- Railway
- Watercourse Realignment
- Tailings and Reclaim Pipeline
- Realignment Dams
- Polishing Pond
- Tailings Management Facility (TMF)
- Mine Rock Area (MRA)
- Open Pit
- Waterbodies
- Creek / River
- James Bay/Great Lakes Watershed Divide
- Existing Watersheds

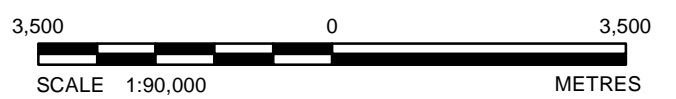

REFERENCE

Open Pit Shell provided by IAMGOLD, May 2013
 Base Data - MNR NRVIS, CANMAP v2008.4
 Produced by Golder Associates Ltd under licence from
 Ontario Ministry of Natural Resources, © Queens Printer 2013
 Projection: Transverse Mercator Datum: NAD 83 Coordinate System: UTM Zone 17

PROJECT		IAMGOLD CÔTÉ GOLD PROJECT	
TITLE		Baseline Surface Water Quality Monitoring Stations	
PROJECT No. 13-1192-0021		SCALE AS SHOWN	REV. 0
DESIGN	RRD	Dec. 2012	FIGURE: 7
GIS	AL	Dec. 2013	
CHECK	NK	Jan. 2014	
REVIEW	MRG	Jan. 2014	



Z:\Projects\2013\13-1192-0021\GIS\MXDs\Reporting\GeoChemistry\Figure_7\SurfaceWaterQualityMonitoringStations.mxd

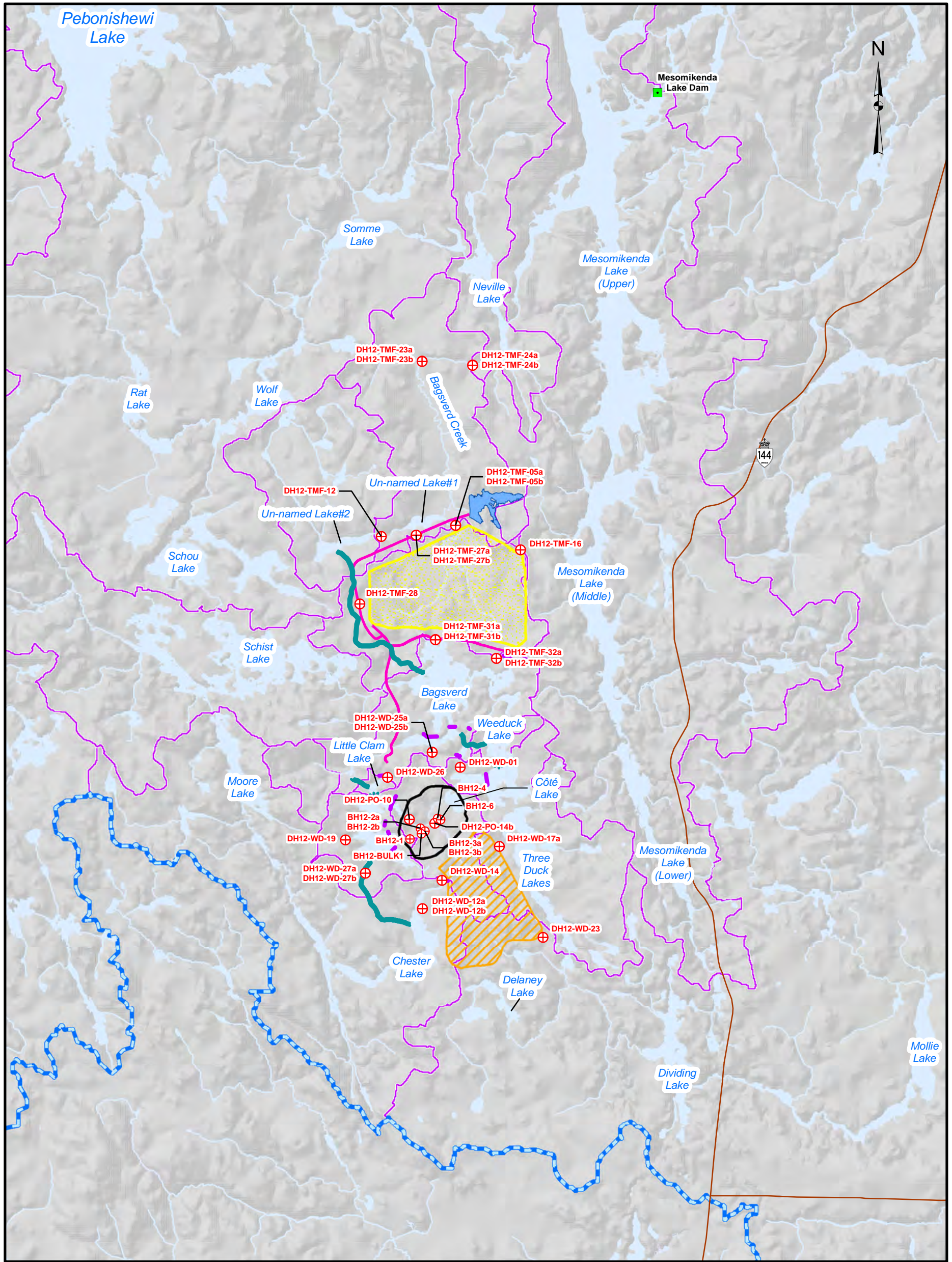

LEGEND

- ⊕ Groundwater Monitoring Well
- Dams
- Major Roads
- Railway
- Watercourse Realignment
- Tailings and Reclaim Pipeline
- Realignment Dams
- Polishing Pond
- Tailings Management Facility (TMF)
- Mine Rock Area (MRA)
- Open Pit
- Waterbodies
- Creek / River
- James Bay/Great Lakes Watershed Divide
- Existing Watersheds

REFERENCE

Open Pit Shell provided by IAMGOLD, May 2013
 Base Data - MNR NRVIS, CANMAP v2008.4
 Produced by Golder Associates Ltd under licence from
 Ontario Ministry of Natural Resources, © Queens Printer 2013
 Projection: Transverse Mercator Datum: NAD 83 Coordinate System: UTM Zone 17

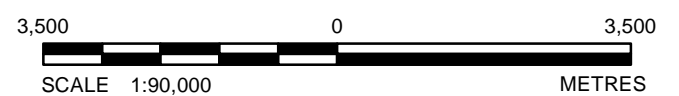

PROJECT	IAMGOLD			CÔTÉ GOLD PROJECT	
TITLE	Baseline Groundwater Quality Monitoring Stations				
	PROJECT No. 13-1192-0021		SCALE AS SHOWN	REV. 0	
	DESIGN	RRD	Dec. 2012	FIGURE: 8	
	GIS	AL	Dec. 2013		
	CHECK	NK	Jan. 2014		
	REVIEW	MRG	Jan. 2014		
Golder Associates Sudbury, Ontario					



APPENDIX A

Water Quality Model Results: Operations Phase

TABLE A1
WATER QUALITY MODELING RESULTS: OPERATIONS PHASE, AVERAGE CONDITION - MOLLIE RIVER WATERSHED
CÔTÉ GOLD PROJECT

Parameter	Units	Aquatic Health Benchmark ^(a)	Human Health Drinking Water Guideline ^(b)	MOLLIE RIVER WATERSHED																			
				Chester Lake				Clam Lake				Little Clam Lake				Bagsverd Lake (South)				Weeduck Lake			
				Med	Max	% > Aquatic Health Benchmark	% > Human Health Drinking Water Guideline	Med	Max	% > Aquatic Health Benchmark	% > Human Health Drinking Water Guideline	Med	Max	% > Aquatic Health Benchmark	% > Human Health Drinking Water Guideline	Med	Max	% > Aquatic Health Benchmark	% > Human Health Drinking Water Guideline	Med	Max	% > Aquatic Health Benchmark	% > Human Health Drinking Water Guideline
Aluminum	mg/L	0.1182	-	0.047	0.051	0%	-	0.049	0.051	0%	-	0.050	0.070	0%	-	0.050	0.057	0%	-	0.050	0.054	0%	-
Ammonia (Total)	mg/L	6.89	-	0.067	0.075	0%	-	0.060	0.070	0%	-	0.062	0.083	0%	-	0.061	0.069	0%	-	0.062	0.066	0%	-
Ammonia (Un-ionized)	mg/L	0.019	-	0.00010	0.00039	0%	-	0.00010	0.00038	0%	-	0.00010	0.00041	0%	-	0.00012	0.00044	0%	-	0.00011	0.00042	0%	-
Antimony	mg/L	0.02	0.006	0.00039	0.00044	0%	0%	0.00034	0.00041	0%	0%	0.00035	0.00048	0%	0%	0.00035	0.00039	0%	0%	0.00035	0.00038	0%	0%
Arsenic	mg/L	0.005	0.01	0.0019	0.0021	0%	0%	0.0018	0.0020	0%	0%	0.0019	0.0025	0%	0%	0.0018	0.0021	0%	0%	0.0019	0.0020	0%	0%
Barium	mg/L	1.0	1	0.0061	0.0067	0%	0%	0.0063	0.0067	0%	0%	0.0065	0.0089	0%	0%	0.0064	0.0073	0%	0%	0.0065	0.0070	0%	0%
Boron	mg/L	1.5	5	0.0052	0.0057	0%	0%	0.0055	0.0057	0%	0%	0.0056	0.0077	0%	0%	0.0055	0.0063	0%	0%	0.0056	0.0060	0%	0%
Cadmium	mg/L	0.000058	0.005	0.000021	0.000022	0%	0%	0.000022	0.000022	0%	0%	0.000022	0.000030	0%	0%	0.000022	0.000025	0%	0%	0.000022	0.000024	0%	0%
Calcium	mg/L	10.465	-	9.9	11	13%	-	9.2	10	13%	-	9.5	13	14%	-	9.4	11	8%	-	9.4	10	0%	-
Chloride	mg/L	120	-	0.81	0.89	0%	-	0.81	0.87	0%	-	0.84	1.1	0%	-	0.82	0.94	0%	-	0.83	0.90	0%	-
Cobalt	mg/L	0.0025	-	0.00028	0.00031	0%	-	0.00029	0.00030	0%	-	0.00030	0.00041	0%	-	0.00029	0.00034	0%	-	0.00030	0.00032	0%	-
Copper	mg/L	0.005	-	0.0012	0.0013	0%	-	0.0012	0.0013	0%	-	0.0012	0.0017	0%	-	0.0012	0.0014	0%	-	0.0012	0.0013	0%	-
Cyanide (Total)	mg/L	-	-	-	-	-	-	-	-	-	-	-	-	-	-	-	-	-	-	-	-	-	-
Cyanide (Free)	mg/L	0.009784	0.2	-	-	-	-	-	-	-	-	-	-	-	-	-	-	-	-	-	-	-	-
Iron	mg/L	0.369	-	0.17	0.18	0%	-	0.18	0.18	0%	-	0.18	0.25	0%	-	0.18	0.21	0%	-	0.18	0.20	0%	-
Lead	mg/L	0.001	0.01	0.000057	0.000062	0%	0%	0.000057	0.000062	0%	0%	0.000060	0.000081	0%	0%	0.000058	0.000067	0%	0%	0.000059	0.000064	0%	0%
Magnesium	mg/L	2.003	-	1.4	1.5	0%	-	1.4	1.5	0%	-	1.5	2.0	0.27%	-	1.5	1.7	0%	-	1.5	1.6	0%	-
Manganese	mg/L	0.7	-	0.060	0.066	0%	-	0.063	0.066	0%	-	0.065	0.089	0%	-	0.064	0.073	0%	-	0.064	0.069	0%	-
Molybdenum	mg/L	0.073	-	0.0012	0.0013	0%	-	0.0011	0.0012	0%	-	0.0012	0.0016	0%	-	0.0012	0.0013	0%	-	0.0012	0.0013	0%	-
Nickel	mg/L	0.025	-	0.0015	0.0017	0%	-	0.0016	0.0017	0%	-	0.0016	0.0023	0%	-	0.0016	0.0019	0%	-	0.0016	0.0018	0%	-
Nitrate	mg/L	13	10	0.12	0.14	0%	0%	0.092	0.12	0%	0%	0.092	0.13	0%	0%	0.097	0.11	0%	0%	0.096	0.10	0%	0%
Phosphorus (Total)	mg/L	0.035	-	0.019	0.022	0%	-	0.017	0.020	0%	-	0.018	0.024	0%	-	0.018	0.020	0%	-	0.018	0.019	0%	-
Potassium	mg/L	373	-	0.52	0.58	0%	-	0.46	0.54	0%	-	0.47	0.64	0%	-	0.47	0.53	0%	-	0.47	0.51	0%	-
Sodium	mg/L	1.3365	-	1.0	1.1	0%	-	1.1	1.1	0%	-	1.1	1.5	2%	-	1.1	1.2	0%	-	1.1	1.2	0%	-
Strontium	mg/L	0.026	-	0.021	0.023	0%	-	0.020	0.023	0%	-	0.021	0.029	1%	-	0.021	0.023	0%	-	0.021	0.022	0%	-
Sulphate	mg/L	218	-	3.1	3.4	0%	-	3.3	3.4	0%	-	3.4	4.6	0%	-	3.3	3.8	0%	-	3.4	3.6	0%	-
Uranium	mg/L	0.015	0.02	0.0013	0.0015	0%	0%	0.0012	0.0014	0%	0%	0.0013	0.0017	0%	0%	0.0013	0.0014	0%	0%	0.0013	0.0014	0%	0%
Vanadium	mg/L	0.006	-	0.0011	0.0012	0%	-	0.0011	0.0012	0%	-	0.0012	0.0016	0%	-	0.0012	0.0013	0%	-	0.0012	0.0013	0%	-
Zinc	mg/L	0.032	-	0.0091	0.010	0%	-	0.0095	0.010	0%	-	0.010	0.013	0%	-	0.010	0.011	0%	-	0.010	0.011	0%	-

Notes:

Med - Median Annual Concentration

Max - Maximum Annual Concentration

% > Aquatic Health Benchmark and % > Human Health Drinking Water Guideline - percentage of days during the climate year that the concentration is greater than the Aquatic Health Benchmark and Human Health Drinking Water Guideline, respectively.

0.001 - denotes concentrations that are greater than the Aquatic Health Benchmark.

0.001 - denotes concentrations that are greater than the Human Health Drinking Water Guideline.

(a) Aquatic Health Benchmark - The benchmark is equal to the most recent of the PWQO or CWQG (or the BCMOE guideline for parameters without a PWQO or CWQG) or the upper limit of background (95th percentile), whichever is higher (with the exception of cyanide, which has a site-specific guideline). If no guideline exists, then background was used as the benchmark.

(b) Human Health Drinking Water Guideline - The guideline is equal to the ODWS and CDWQG (where the same). For arsenic, the guideline is equal to the CDWQG. For nitrate, the benchmark is equal to the ODWS.

TABLE A1
WATER QUALITY MODELING RESULTS: OPERATIONS PHASE, AVERAGE YEAR CONDITION - MOLLIE RIVER WATERSHED
CÔTÉ GOLD PROJECT

Parameter	Units	Aquatic Health Benchmark ^(a)	Human Health Drinking Water Guideline ^(b)	MOLLIE RIVER WATERSHED															
				Three Duck Lakes (Upper/Middle)				Three Duck Lakes (Lower)				Delaney Lake				Dividing Lake			
				Med	Max	% > Aquatic Health Benchmark	% > Human Health Drinking Water Guideline	Med	Max	% > Aquatic Health Benchmark	% > Human Health Drinking Water Guideline	Med	Max	% > Aquatic Health Benchmark	% > Human Health Drinking Water Guideline	Med	Max	% > Aquatic Health Benchmark	% > Human Health Drinking Water Guideline
Aluminum	mg/L	0.1182	-	0.050	0.061	0%	-	0.050	0.052	0%	-	0.064	0.082	0%	-	0.052	0.052	0%	-
Ammonia (Total)	mg/L	6.89	-	0.069	0.095	0%	-	0.067	0.073	0%	-	0.082	0.11	0%	-	0.065	0.066	0%	-
Ammonia (Un-ionized)	mg/L	0.019	-	0.00015	0.00053	0%	-	0.00011	0.00043	0%	-	0.00016	0.00055	0%	-	0.00011	0.00044	0%	-
Antimony	mg/L	0.02	0.006	0.00040	0.00060	0%	0%	0.00041	0.00045	0%	0%	0.00045	0.00064	0%	0%	0.00039	0.00039	0%	0%
Arsenic	mg/L	0.005	0.01	0.0020	0.0026	0%	0%	0.0020	0.0022	0%	0%	0.0024	0.0032	0%	0%	0.0020	0.0020	0%	0%
Barium	mg/L	1.0	1	0.0066	0.0082	0%	0%	0.0066	0.0069	0%	0%	0.0083	0.011	0%	0%	0.0067	0.0067	0%	0%
Boron	mg/L	1.5	5	0.0056	0.0069	0%	0%	0.0057	0.0059	0%	0%	0.0071	0.0092	0%	0%	0.0057	0.0058	0%	0%
Cadmium	mg/L	0.000058	0.005	0.000022	0.000027	0%	0%	0.000022	0.000023	0%	0%	0.000028	0.000036	0%	0%	0.000023	0.000023	0%	0%
Calcium	mg/L	10.465	-	10	14	48%	-	11	11	54%	-	12	16	74%	-	10	10	0%	-
Chloride	mg/L	120	-	0.86	1.09	0%	-	0.87	0.92	0%	-	1.1	1.4	0%	-	0.87	0.87	0%	-
Cobalt	mg/L	0.0025	-	0.0002996	0.0003704	0%	-	0.00030	0.00031	0%	-	0.00038	0.00049	0%	-	0.00031	0.00031	0%	-
Copper	mg/L	0.005	-	0.0013	0.0016	0%	-	0.0013	0.0014	0%	-	0.0016	0.0021	0%	-	0.0013	0.0013	0%	-
Cyanide (Total)	mg/L	-	-	-	-	-	-	-	-	-	-	-	-	-	-	-	-	-	-
Cyanide (Free)	mg/L	0.009784	0.2	-	-	-	-	-	-	-	-	-	-	-	-	-	-	-	-
Iron	mg/L	0.369	-	0.18	0.22	0%	-	0.18	0.19	0%	-	0.23	0.30	0%	-	0.19	0.19	0%	-
Lead	mg/L	0.001	0.01	6.054E-05	7.625E-05	0%	0%	0.000061	0.000064	0%	0%	0.000076	0.00010	0%	0%	0.000061	0.000062	0%	0%
Magnesium	mg/L	2.003	-	1.5	1.8	0%	-	1.5	1.5	0%	-	1.9	2.4	32%	-	1.5	1.5	0%	-
Manganese	mg/L	0.7	-	0.065	0.079	0%	-	0.065	0.068	0%	-	0.082	0.11	0%	-	0.066	0.067	0%	-
Molybdenum	mg/L	0.073	-	0.0012	0.0016	0%	-	0.0012	0.0013	0%	-	0.0015	0.0020	0%	-	0.0012	0.0012	0%	-
Nickel	mg/L	0.025	-	0.0016	0.0020	0%	-	0.0016	0.0017	0%	-	0.0021	0.0027	0%	-	0.0017	0.0017	0%	-
Nitrate	mg/L	13	10	0.11	0.20	0%	0%	0.12	0.13	0%	0%	0.13	0.19	0%	0%	0.11	0.11	0%	0%
Phosphorus (Total)	mg/L	0.035	-	0.020	0.028	0%	-	0.020	0.022	0%	-	0.023	0.032	0%	-	0.019	0.020	0%	-
Potassium	mg/L	373	-	0.52	0.78	0%	-	0.55	0.59	0%	-	0.61	0.85	0%	-	0.52	0.52	0%	-
Sodium	mg/L	1.3365	-	1.1	1.3	3%	-	1.1	1.1	0%	-	1.4	1.8	61%	-	1.1	1.1	0%	-
Strontium	mg/L	0.026	-	0.022	0.029	27%	-	0.023	0.024	0%	-	0.027	0.036	56%	-	0.022	0.022	0%	-
Sulphate	mg/L	218	-	3.4	4.2	0%	-	3.4	3.6	0%	-	4.3	5.5	0%	-	3.5	3.5	0%	-
Uranium	mg/L	0.015	0.02	0.0014	0.0019	0%	0%	0.0014	0.0015	0%	0%	0.0016	0.0022	0%	0%	0.0014	0.0014	0%	0%
Vanadium	mg/L	0.006	-	0.0012	0.0015	0%	-	0.0012	0.0013	0%	-	0.0015	0.0020	0%	-	0.0012	0.0012	0%	-
Zinc	mg/L	0.032	-	0.010	0.012	0%	-	0.010	0.010	0%	-	0.012	0.016	0%	-	0.010	0.010	0%	-

Notes:

Med - Median Annual Concentration

Max - Maximum Annual Concentration

% > Aquatic Health Benchmark and % > Human Health Drinking Water Guideline - percentage of days during the climate year that the concentration is greater than the Aquatic Health Benchmark and Human Health Drinking Water Guideline, respectively.

0.001 - denotes concentrations that are greater than the Aquatic Health Benchmark.

0.001 - denotes concentrations that are greater than the Human Health Drinking Water Guideline.

(a) Aquatic Health Benchmark - The benchmark is equal to the most recent of the PWQO or CWQG (or the BCMOE guideline for parameters without a PWQO or CWQG) or the upper limit of background (95th percentile), whichever is higher (with the exception of cyanide, which has a site-specific guideline). If no guideline exists, then background was used as the benchmark.

(b) Human Health Drinking Water Guideline - The guideline is equal to the ODWS and CDWQG (where the same). For arsenic, the guideline is equal to the CDWQG. For nitrate, the benchmark is equal to the ODWS.

TABLE A2
WATER QUALITY MODELING RESULTS: OPERATIONS PHASE, 1:25-YEAR DRY CONDITION - MOLLIE RIVER WATERSHED
CÔTÉ GOLD PROJECT

Parameter	Units	Aquatic Health Benchmark ^(a)	Human Health Drinking Water Guideline ^(b)	MOLLIE RIVER WATERSHED																			
				Chester Lake				Clam Lake				Little Clam Lake				Bagsverd Lake (South)				Weeduck Lake			
				Med	Max	% > Aquatic Health Benchmark	% > Human Health Drinking Water Guideline	Med	Max	% > Aquatic Health Benchmark	% > Human Health Drinking Water Guideline	Med	Max	% > Aquatic Health Benchmark	% > Human Health Drinking Water Guideline	Med	Max	% > Aquatic Health Benchmark	% > Human Health Drinking Water Guideline	Med	Max	% > Aquatic Health Benchmark	% > Human Health Drinking Water Guideline
Aluminum	mg/L	0.1182	-	0.049	0.056	0%	-	0.050	0.054	0%	-	0.052	0.064	0%	-	0.050	0.061	0%	-	0.051	0.056	0%	-
Ammonia (Total)	mg/L	6.89	-	0.073	0.080	0%	-	0.067	0.073	0%	-	0.068	0.083	0%	-	0.064	0.077	0%	-	0.065	0.071	0%	-
Ammonia (Un-ionized)	mg/L	0.019	-	0.00012	0.00047	0%	-	0.00011	0.00044	0%	-	0.00012	0.00051	0%	-	0.00013	0.00049	0%	-	0.00012	0.00044	0%	-
Antimony	mg/L	0.02	0.006	0.00047	0.00053	0%	0%	0.00040	0.00046	0%	0%	0.00042	0.00047	0%	0%	0.00037	0.00044	0%	0%	0.00037	0.00040	0%	0%
Arsenic	mg/L	0.005	0.01	0.0022	0.0024	0%	0%	0.0020	0.0022	0%	0%	0.0021	0.0024	0%	0%	0.0019	0.0023	0%	0%	0.0019	0.0021	0%	0%
Barium	mg/L	1.0	1	0.0066	0.0074	0%	0%	0.0065	0.0071	0%	0%	0.0068	0.0082	0%	0%	0.0065	0.0078	0%	0%	0.0066	0.0072	0%	0%
Boron	mg/L	1.5	5	0.0056	0.0063	0%	0%	0.0056	0.0060	0%	0%	0.0058	0.0071	0%	0%	0.0056	0.0067	0%	0%	0.00568	0.0062	0%	0%
Cadmium	mg/L	0.000058	0.005	0.000022	0.000025	0%	0%	0.000022	0.000024	0%	0%	0.000023	0.000028	0%	0%	0.000022	0.000027	0%	0%	0.000022	0.000024	0%	0%
Calcium	mg/L	10.465	-	12	13	82%	-	10	12	35%	-	11	12	56%	-	9.7	12	33%	-	9.8	11	14%	-
Chloride	mg/L	120	-	0.90	0.99	0%	-	0.85	0.94	0%	-	0.89	1.1	0%	-	0.83	1.01	0%	-	0.85	0.93	0%	-
Cobalt	mg/L	0.0025	-	0.00030	0.00034	0%	-	0.00030	0.00032	0%	-	0.00031	0.00038	0%	-	0.00030	0.00036	0%	-	0.00030	0.00033	0%	-
Copper	mg/L	0.005	-	0.0014	0.0015	0%	-	0.0013	0.0014	0%	-	0.0013	0.0016	0%	-	0.0012	0.0015	0%	-	0.0013	0.0014	0%	-
Cyanide (Total)	mg/L	-	-	-	-	-	-	-	-	-	-	-	-	-	-	-	-	-	-	-	-	-	-
Cyanide (Free)	mg/L	0.009784	0.2	-	-	-	-	-	-	-	-	-	-	-	-	-	-	-	-	-	-	-	-
Iron	mg/L	0.369	-	0.17	0.20	0%	-	0.18	0.19	0%	-	0.19	0.23	0%	-	0.18	0.22	0%	-	0.19	0.20	0%	-
Lead	mg/L	0.001	0.01	0.00006	0.00007	0%	0%	0.00006	0.00007	0%	0%	0.00006	0.00008	0%	0%	0.000059	0.000072	0%	0%	0.000060	0.000066	0%	0%
Magnesium	mg/L	2.003	-	1.4	1.6	0%	-	1.5	1.6	0%	-	1.5	1.9	0.00%	-	1.5	1.8	0%	-	1.5	1.6	0%	-
Manganese	mg/L	0.7	-	0.064	0.073	0%	-	0.064	0.069	0%	-	0.067	0.081	0%	-	0.064	0.078	0%	-	0.065	0.071	0%	-
Molybdenum	mg/L	0.073	-	0.0013	0.0014	0%	-	0.0012	0.0013	0%	-	0.0013	0.0015	0%	-	0.0012	0.0014	0%	-	0.0012	0.0013	0%	-
Nickel	mg/L	0.025	-	0.0016	0.0018	0%	-	0.0016	0.0017	0%	-	0.0017	0.0021	0%	-	0.0016	0.0020	0%	-	0.0017	0.0018	0%	-
Nitrate	mg/L	13	10	0.14	0.16	0%	0%	0.115	0.13	0%	0%	0.119	0.14	0%	0%	0.106	0.13	0%	0%	0.105	0.11	0%	0%
Phosphorus (Total)	mg/L	0.035	-	0.023	0.025	0%	-	0.020	0.022	0%	-	0.021	0.024	0%	-	0.019	0.022	0%	-	0.019	0.020	0%	-
Potassium	mg/L	373	-	0.63	0.69	0%	-	0.53	0.60	0%	-	0.55	0.63	0%	-	0.50	0.59	0%	-	0.50	0.54	0%	-
Sodium	mg/L	1.3365	-	1.1	1.2	0%	-	1.1	1.2	0%	-	1.1	1.4	0.3%	-	1.1	1.3	0%	-	1.1	1.2	0%	-
Strontium	mg/L	0.026	-	0.024	0.026	4%	-	0.022	0.024	0%	-	0.023	0.027	0.3%	-	0.021	0.026	0%	-	0.022	0.023	0%	-
Sulphate	mg/L	218	-	3.4	3.8	0%	-	3.4	3.6	0%	-	3.5	4.3	0%	-	3.4	4.1	0%	-	3.4	3.7	0%	-
Uranium	mg/L	0.015	0.02	0.0016	0.0017	0%	0%	0.0014	0.0015	0%	0%	0.0014	0.0017	0%	0%	0.0013	0.0016	0%	0%	0.0013	0.0014	0%	0%
Vanadium	mg/L	0.006	-	0.0013	0.0014	0%	-	0.0012	0.0013	0%	-	0.0012	0.0015	0%	-	0.0012	0.0014	0%	-	0.0012	0.0013	0%	-
Zinc	mg/L	0.032	-	0.0097	0.011	0%	-	0.0098	0.010	0%	-	0.010	0.012	0%	-	0.010	0.012	0%	-	0.010	0.011	0%	-

Notes:

Med - Median Annual Concentration

Max - Maximum Annual Concentration

% > Aquatic Health Benchmark and % > Human Health Drinking Water Guideline - percentage of days during the climate year that the concentration is greater than the Aquatic Health Benchmark and Human Health Drinking Water Guideline, respectively.

0.001 - denotes concentrations that are greater than the Aquatic Health Benchmark.

0.001 - denotes concentrations that are greater than the Human Health Drinking Water Guideline.

(a) Aquatic Health Benchmark - The benchmark is equal to the most recent of the PWQO or CWQG (or the BCMOE guideline for parameters without a PWQO or CWQG) or the upper limit of background (95th percentile), whichever is higher (with the exception of cyanide, which has a site-specific guideline). If no guideline exists, then background was used as the benchmark.

(b) Human Health Drinking Water Guideline - The guideline is equal to the ODWS and CDWQG (where the same). For arsenic, the guideline is equal to the CDWQG. For nitrate, the benchmark is equal to the ODWS.

TABLE A2
WATER QUALITY MODELING RESULTS: OPERATIONS PHASE, 1:25-YEAR DRY CONDITION - MOLLIE RIVER WATERSHED
CÔTÉ GOLD PROJECT

Parameter	Units	Aquatic Health Benchmark ^(a)	Human Health Drinking Water Guideline ^(b)	MOLLIE RIVER WATERSHED															
				Three Duck Lakes (Upper/Middle)				Three Duck Lakes (Lower)				Delaney Lake				Dividing Lake			
				Med	Max	% > Aquatic Health Benchmark	% > Human Health Drinking Water Guideline	Med	Max	% > Aquatic Health Benchmark	% > Human Health Drinking Water Guideline	Med	Max	% > Aquatic Health Benchmark	% > Human Health Drinking Water Guideline	Med	Max	% > Aquatic Health Benchmark	% > Human Health Drinking Water Guideline
Aluminum	mg/L	0.1182	-	0.053	0.068	0%	-	0.050	0.053	0%	-	0.069	0.107	0%	-	0.052	0.053	0%	-
Ammonia (Total)	mg/L	6.89	-	0.079	0.111	0%	-	0.072	0.078	0%	-	0.099	0.15	0%	-	0.070	0.071	0%	-
Ammonia (Un-ionized)	mg/L	0.019	-	0.00018	0.00067	0%	-	0.00012	0.00047	0%	-	0.00022	0.00080	0%	-	0.00012	0.00047	0%	-
Antimony	mg/L	0.02	0.006	0.00054	0.00078	0%	0%	0.00045	0.00050	0%	0%	0.00057	0.00097	0%	0%	0.00041	0.00042	0%	0%
Arsenic	mg/L	0.005	0.01	0.0024	0.0033	0%	0%	0.0021	0.0023	0%	0%	0.0028	0.0045	0%	0%	0.0021	0.0021	0%	0%
Barium	mg/L	1.0	1	0.0073	0.0094	0%	0%	0.0067	0.0071	0%	0%	0.0091	0.014	0%	0%	0.0068	0.0069	0%	0%
Boron	mg/L	1.5	5	0.0061	0.0078	0%	0%	0.0057	0.0060	0%	0%	0.0078	0.0121	0%	0%	0.0058	0.0059	0%	0%
Cadmium	mg/L	0.000058	0.005	0.000023	0.000030	0%	0%	0.000022	0.000023	0%	0%	0.000030	0.000047	0%	0%	0.000023	0.000023	0%	0%
Calcium	mg/L	10.465	-	13	18	58%	-	11	12	100%	-	15	24	89%	-	11	11	100%	-
Chloride	mg/L	120	-	1.00	1.32	0%	-	0.89	0.96	0%	-	1.2	1.9	0%	-	0.89	0.90	0%	-
Cobalt	mg/L	0.0025	-	0.000329	0.000421	0%	-	0.00030	0.00032	0%	-	0.00041	0.00065	0%	-	0.00031	0.00032	0%	-
Copper	mg/L	0.005	-	0.0015	0.0020	0%	-	0.0013	0.0014	0%	-	0.0018	0.0029	0%	-	0.0013	0.0013	0%	-
Cyanide (Total)	mg/L	-	-	-	-	-	-	-	-	-	-	-	-	-	-	-	-	-	-
Cyanide (Free)	mg/L	0.009784	0.2	-	-	-	-	-	-	-	-	-	-	-	-	-	-	-	-
Iron	mg/L	0.369	-	0.19	0.23	0%	-	0.18	0.19	0%	-	0.25	0.38	5%	-	0.19	0.19	0%	-
Lead	mg/L	0.001	0.01	0.000069	0.000090	0%	0%	0.000062	0.000066	0%	0%	0.000084	0.00013	0%	0%	0.000063	0.000064	0%	0%
Magnesium	mg/L	2.003	-	1.6	2.0	0%	-	1.5	1.5	0%	-	2.0	3.1	62%	-	1.5	1.5	0%	-
Manganese	mg/L	0.7	-	0.070	0.089	0%	-	0.065	0.069	0%	-	0.089	0.14	0%	-	0.067	0.068	0%	-
Molybdenum	mg/L	0.073	-	0.0014	0.0019	0%	-	0.0013	0.0014	0%	-	0.0017	0.0027	0%	-	0.0013	0.0013	0%	-
Nickel	mg/L	0.025	-	0.0017	0.0022	0%	-	0.0016	0.0017	0%	-	0.0022	0.0035	0%	-	0.0017	0.0017	0%	-
Nitrate	mg/L	13	10	0.16	0.24	0%	0%	0.14	0.15	0%	0%	0.18	0.26	0%	0%	0.12	0.12	0%	0%
Phosphorus (Total)	mg/L	0.035	-	0.026	0.036	15%	-	0.022	0.024	0%	-	0.028	0.047	26%	-	0.020	0.021	0%	-
Potassium	mg/L	373	-	0.71	1.01	0%	-	0.60	0.66	0%	-	0.76	1.27	0%	-	0.55	0.56	0%	-
Sodium	mg/L	1.3365	-	1.2	1.5	27%	-	1.1	1.2	0%	-	1.5	2.4	78%	-	1.1	1.2	0%	-
Strontium	mg/L	0.026	-	0.027	0.037	51%	-	0.024	0.026	0%	-	0.031	0.050	81%	-	0.023	0.023	0%	-
Sulphate	mg/L	218	-	3.7	4.7	0%	-	3.4	3.6	0%	-	4.7	7.3	0%	-	3.5	3.6	0%	-
Uranium	mg/L	0.015	0.02	0.002	0.002	0%	0%	0.001	0.002	0%	0%	0.0019	0.0032	0%	0%	0.0014	0.0014	0%	0%
Vanadium	mg/L	0.006	-	0.001	0.002	0%	-	0.001	0.001	0%	-	0.0017	0.0027	0%	-	0.0012	0.0013	0%	-
Zinc	mg/L	0.032	-	0.011	0.014	0%	-	0.010	0.010	0%	-	0.014	0.021	0%	-	0.010	0.010	0%	-

Notes:

Med - Median Annual Concentration

Max - Maximum Annual Concentration

% > Aquatic Health Benchmark and % > Human Health Drinking Water Guideline - percentage of days during the climate year that the concentration is greater than the Aquatic Health Benchmark and Human Health Drinking Water Guideline, respectively.

0.001 - denotes concentrations that are greater than the Aquatic Health Benchmark.

0.001 - denotes concentrations that are greater than the Human Health Drinking Water Guideline.

(a) Aquatic Health Benchmark - The benchmark is equal to the most recent of the PWQO or CWQG (or the BCMOE guideline for parameters without a PWQO or CWQG) or the upper limit of background (95th percentile), whichever is higher (with the exception of cyanide, which has a site-specific guideline). If no guideline exists, then background was used as the benchmark.

(b) Human Health Drinking Water Guideline - The guideline is equal to the ODWS and CDWQG (where the same). For arsenic, the guideline is equal to the CDWQG. For nitrate, the benchmark is equal to the ODWS.

TABLE A3
WATER QUALITY MODELING RESULTS: OPERATIONS PHASE, 1:25-YEAR WET CONDITION - MOLLIE RIVER WATERSHED
CÔTÉ GOLD PROJECT

Parameter	Units	Aquatic Health Benchmark ^(a)	Human Health Drinking Water Guideline ^(b)	MOLLIE RIVER WATERSHED																			
				Chester Lake				Clam Lake				Little Clam Lake				Bagsverd Lake (South)				Weeduck Lake			
				Med	Max	% > Aquatic Health Benchmark	% > Human Health Drinking Water Guideline	Med	Max	% > Aquatic Health Benchmark	% > Human Health Drinking Water Guideline	Med	Max	% > Aquatic Health Benchmark	% > Human Health Drinking Water Guideline	Med	Max	% > Aquatic Health Benchmark	% > Human Health Drinking Water Guideline	Med	Max	% > Aquatic Health Benchmark	% > Human Health Drinking Water Guideline
Aluminum	mg/L	0.1182	-	0.048	0.054	0%	-	0.049	0.052	0%	-	0.050	0.076	0%	-	0.050	0.056	0%	-	0.050	0.054	0%	-
Ammonia (Total)	mg/L	6.89	-	0.065	0.074	0%	-	0.062	0.069	0%	-	0.062	0.097	0%	-	0.063	0.068	0%	-	0.062	0.067	0%	-
Ammonia (Un-ionized)	mg/L	0.019	-	0.00011	0.00041	0%	-	0.00010	0.00039	0%	-	0.00010	0.00044	0%	-	0.00012	0.00044	0%	-	0.00011	0.00042	0%	-
Antimony	mg/L	0.02	0.006	0.00039	0.00045	0%	0%	0.00036	0.00040	0%	0%	0.00036	0.00056	0%	0%	0.00036	0.00039	0%	0%	0.00036	0.00038	0%	0%
Arsenic	mg/L	0.005	0.01	0.0018	0.0021	0%	0%	0.0018	0.0020	0%	0%	0.0018	0.0029	0%	0%	0.0019	0.0021	0%	0%	0.0019	0.0020	0%	0%
Barium	mg/L	1.0	1	0.0062	0.0070	0%	0%	0.0063	0.0068	0%	0%	0.0064	0.010	0%	0%	0.0065	0.0072	0%	0%	0.0065	0.0069	0%	0%
Boron	mg/L	1.5	5	0.0053	0.0060	0%	0%	0.0054	0.0058	0%	0%	0.0055	0.0084	0%	0%	0.0056	0.0062	0%	0%	0.0056	0.0059	0%	0%
Cadmium	mg/L	0.000058	0.005	0.000021	0.000024	0%	0%	0.000021	0.000023	0%	0%	0.000022	0.000033	0%	0%	0.000022	0.000025	0%	0%	0.000022	0.000023	0%	0%
Calcium	mg/L	10.465	-	9.8	11	15%	-	9.5	10	0%	-	9.5	15	3%	-	9.5	10	0%	-	9.5	10	0%	-
Chloride	mg/L	120	-	0.80	0.92	0%	-	0.80	0.88	0%	-	0.82	1.3	0%	-	0.84	0.92	0%	-	0.83	0.89	0%	-
Cobalt	mg/L	0.0025	-	0.00028	0.00032	0%	-	0.00029	0.00031	0%	-	0.00030	0.00045	0%	-	0.00030	0.00033	0%	-	0.00030	0.00032	0%	-
Copper	mg/L	0.005	-	0.0012	0.0014	0%	-	0.0012	0.0013	0%	-	0.0012	0.0019	0%	-	0.0012	0.0014	0%	-	0.0012	0.0013	0%	-
Cyanide (Total)	mg/L	-	-	-	-	-	-	-	-	-	-	-	-	-	-	-	-	-	-	-	-	-	-
Cyanide (Free)	mg/L	0.009784	0.2	-	-	-	-	-	-	-	-	-	-	-	-	-	-	-	-	-	-	-	-
Iron	mg/L	0.369	-	0.17	0.19	0%	-	0.18	0.19	0%	-	0.18	0.27	0%	-	0.18	0.20	0%	-	0.18	0.20	0%	-
Lead	mg/L	0.001	0.01	0.00006	0.00006	0%	0%	0.00006	0.00006	0%	0%	0.00006	0.00009	0%	0%	0.000059	0.000066	0%	0%	0.000059	0.000063	0%	0%
Magnesium	mg/L	2.003	-	1.4	1.6	0%	-	1.4	1.5	0%	-	1.5	2.2	0.82%	-	1.5	1.6	0%	-	1.5	1.6	0%	-
Manganese	mg/L	0.7	-	0.061	0.069	0%	-	0.062	0.067	0%	-	0.064	0.097	0%	-	0.065	0.072	0%	-	0.064	0.068	0%	-
Molybdenum	mg/L	0.073	-	0.0011	0.0013	0%	-	0.0011	0.0013	0%	-	0.0012	0.0018	0%	-	0.0012	0.0013	0%	-	0.0012	0.0013	0%	-
Nickel	mg/L	0.025	-	0.0015	0.0018	0%	-	0.0015951	0.0017005	0%	-	0.0016	0.0025	0%	-	0.0016	0.0018	0%	-	0.0016	0.0018	0%	-
Nitrate	mg/L	13	10	0.12	0.15	0%	0%	0.103	0.12	0%	0%	0.103	0.16	0%	0%	0.099	0.11	0%	0%	0.098	0.11	0%	0%
Phosphorus (Total)	mg/L	0.035	-	0.019	0.022	0%	-	0.018	0.020	0%	-	0.018	0.028	0%	-	0.018	0.020	0%	-	0.018	0.019	0%	-
Potassium	mg/L	373	-	0.51	0.59	0%	-	0.49	0.53	0%	-	0.49	0.75	0%	-	0.48	0.52	0%	-	0.48	0.52	0%	-
Sodium	mg/L	1.3365	-	1.0	1.2	0%	-	1.1	1.1	0%	-	1.1	1.7	2%	-	1.1	1.2	0%	-	1.1	1.2	0%	-
Strontium	mg/L	0.026	-	0.021	0.024	0%	-	0.021	0.022	0%	-	0.021	0.032	2%	-	0.021	0.023	0%	-	0.021	0.022	0%	-
Sulphate	mg/L	218	-	3.2	3.6	0%	-	3.3	3.5	0%	-	3.3	5.1	0%	-	3.4	3.7	0%	-	3.4	3.6	0%	-
Uranium	mg/L	0.015	0.02	0.0013	0.0015	0%	0%	0.0013	0.0014	0%	0%	0.0013	0.0020	0%	0%	0.0013	0.0014	0%	0%	0.0013	0.0014	0%	0%
Vanadium	mg/L	0.006	-	0.0011	0.0013	0%	-	0.0011	0.0012	0%	-	0.0011	0.0018	0%	-	0.0012	0.0013	0%	-	0.0012	0.0012	0%	-
Zinc	mg/L	0.032	-	0.0092	0.010	0%	-	0.0094	0.010	0%	-	0.010	0.015	0%	-	0.010	0.011	0%	-	0.010	0.010	0%	-

Notes:

Med - Median Annual Concentration

Max - Maximum Annual Concentration

% > Aquatic Health Benchmark and % > Human Health Drinking Water Guideline - percentage of days during the climate year that the concentration is greater than the Aquatic Health Benchmark and Human Health Drinking Water Guideline, respectively.

0.001 - denotes concentrations that are greater than the Aquatic Health Benchmark.

0.001 - denotes concentrations that are greater than the Human Health Drinking Water Guideline.

(a) Aquatic Health Benchmark - The benchmark is equal to the most recent of the PWQO or CWQG (or the BCMOE guideline for parameters without a PWQO or CWQG) or the upper limit of background (95th percentile), whichever is higher (with the exception of cyanide, which has a site-specific guideline). If no guideline exists, then background was used as the benchmark.

(b) Human Health Drinking Water Guideline - The guideline is equal to the ODWS and CDWQG (where the same). For arsenic, the guideline is equal to the CDWQG. For nitrate, the benchmark is equal to the ODWS.

TABLE A3
WATER QUALITY MODELING RESULTS: OPERATIONS PHASE, 1:25-YEAR WET CONDITION - MOLLIE RIVER WATERSHED
CÔTÉ GOLD PROJECT

Parameter	Units	Aquatic Health Benchmark ^(a)	Human Health Drinking Water Guideline ^(b)	MOLLIE RIVER WATERSHED															
				Three Duck Lakes (Upper/Middle)				Three Duck Lakes (Lower)				Delaney Lake				Dividing Lake			
				Med	Max	% > Aquatic Health Benchmark	% > Human Health Drinking Water Guideline	Med	Max	% > Aquatic Health Benchmark	% > Human Health Drinking Water Guideline	Med	Max	% > Aquatic Health Benchmark	% > Human Health Drinking Water Guideline	Med	Max	% > Aquatic Health Benchmark	% > Human Health Drinking Water Guideline
Aluminum	mg/L	0.1182	-	0.049	0.061	0%	-	0.050	0.052	0%	-	0.060	0.078	0%	-	0.052	0.053	0%	-
Ammonia (Total)	mg/L	6.89	-	0.066	0.099	0%	-	0.073	0.076	0%	-	0.076	0.11	0%	-	0.071	0.074	0%	-
Ammonia (Un-ionized)	mg/L	0.019	-	0.00015	0.00055	0%	-	0.00011	0.00044	0%	-	0.00015	0.00056	0%	-	0.00012	0.00047	0%	-
Antimony	mg/L	0.02	0.006	0.00039	0.00062	0%	0%	0.00044	0.00048	0%	0%	0.00042	0.00064	0%	0%	0.00043	0.00045	0%	0%
Arsenic	mg/L	0.005	0.01	0.0019	0.0027	0%	0%	0.0021	0.0022	0%	0%	0.0022	0.0031	0%	0%	0.0021	0.0022	0%	0%
Barium	mg/L	1.0	1	0.0063	0.0081	0%	0%	0.0067	0.0070	0%	0%	0.0078	0.010	0%	0%	0.0068	0.0069	0%	0%
Boron	mg/L	1.5	5	0.0054	0.0069	0%	0%	0.0057	0.0059	0%	0%	0.0067	0.0088	0%	0%	0.0058	0.0059	0%	0%
Cadmium	mg/L	0.000058	0.005	0.000021	0.000027	0%	0%	0.000022	0.000023	0%	0%	0.000026	0.000034	0%	0%	0.000023	0.000023	0%	0%
Calcium	mg/L	10.465	-	10	15	38%	-	11	12	59%	-	11	16	65%	-	11	11	100%	-
Chloride	mg/L	120	-	0.83	1.09	0%	-	0.90	0.93	0%	-	1.0	1.4	0%	-	0.90	0.92	0%	-
Cobalt	mg/L	0.0025	-	0.00029	0.00037	0%	-	0.00030	0.00032	0%	-	0.00036	0.00047	0%	-	0.00031	0.00032	0%	-
Copper	mg/L	0.005	-	0.0012	0.0017	0%	-	0.0013	0.0014	0%	-	0.0015	0.0020	0%	-	0.0013	0.0014	0%	-
Cyanide (Total)	mg/L	-	-	-	-	-	-	-	-	-	-	-	-	-	-	-	-	-	-
Cyanide (Free)	mg/L	0.009784	0.2	-	-	-	-	-	-	-	-	-	-	-	-	-	-	-	-
Iron	mg/L	0.369	-	0.18	0.22	0%	-	0.18	0.19	0%	-	0.22	0.28	0%	-	0.19	0.19	0%	-
Lead	mg/L	0.001	0.01	0.000058	0.000076	0%	0%	0.000063	0.000065	0%	0%	0.000071	0.00009	0%	0%	0.000063	0.000064	0%	0%
Magnesium	mg/L	2.003	-	1.4	1.8	0%	-	1.5	1.5	0%	-	1.8	2.3	37%	-	1.5	1.5	0%	-
Manganese	mg/L	0.7	-	0.063	0.079	0%	-	0.065	0.068	0%	-	0.077	0.10	0%	-	0.067	0.068	0%	-
Molybdenum	mg/L	0.073	-	0.0012	0.0016	0%	-	0.0013	0.0013	0%	-	0.0014	0.0019	0%	-	0.0013	0.0013	0%	-
Nickel	mg/L	0.025	-	0.0016	0.0020	0%	-	0.0016	0.0017	0%	-	0.0020	0.0025	0%	-	0.0017	0.0017	0%	-
Nitrate	mg/L	13	10	0.12	0.22	0%	0%	0.13	0.15	0%	0%	0.12	0.20	0%	0%	0.12	0.13	0%	0%
Phosphorus (Total)	mg/L	0.035	-	0.019	0.029	0%	-	0.021	0.023	0%	-	0.022	0.031	0%	-	0.021	0.022	0%	-
Potassium	mg/L	373	-	0.52	0.81	0%	-	0.58	0.63	0%	-	0.57	0.84	0%	-	0.56	0.59	0%	-
Sodium	mg/L	1.3365	-	1.1	1.3	4%	-	1.1	1.2	0%	-	1.3	1.7	49%	-	1.1	1.2	0%	-
Strontium	mg/L	0.026	-	0.021	0.030	25%	-	0.023	0.025	0%	-	0.025	0.035	45%	-	0.023	0.024	0%	-
Sulphate	mg/L	218	-	3.3	4.2	0%	-	3.4	3.6	0%	-	4.0	5.3	0%	-	3.5	3.6	0%	-
Uranium	mg/L	0.015	0.02	0.0013	0.0019	0%	0%	0.0015	0.0016	0%	0%	0.0015	0.0022	0%	0%	0.0014	0.0015	0%	0%
Vanadium	mg/L	0.006	-	0.0012	0.0015	0%	-	0.0013	0.0013	0%	-	0.0014	0.0019	0%	-	0.0013	0.0013	0%	-
Zinc	mg/L	0.032	-	0.009	0.012	0%	-	0.010	0.010	0%	-	0.012	0.015	0%	-	0.010	0.010	0%	-

Notes:

Med - Median Annual Concentration

Max - Maximum Annual Concentration

% > Aquatic Health Benchmark and % > Human Health Drinking Water Guideline - percentage of days during the climate year that the concentration is greater than the Aquatic Health Benchmark and Human Health Drinking Water Guideline, respectively.

0.001 - denotes concentrations that are greater than the Aquatic Health Benchmark.

0.001 - denotes concentrations that are greater than the Human Health Drinking Water Guideline.

(a) Aquatic Health Benchmark - The benchmark is equal to the most recent of the PWQO or CWQG (or the BCMOE guideline for parameters without a PWQO or CWQG) or the upper limit of background (95th percentile), whichever is higher (with the exception of cyanide, which has a site-specific guideline). If no guideline exists, then background was used as the benchmark.

(b) Human Health Drinking Water Guideline - The guideline is equal to the ODWS and CDWQG (where the same). For arsenic, the guideline is equal to the CDWQG. For nitrate, the benchmark is equal to the ODWS.

TABLE A4-i
WATER QUALITY MODELING RESULTS: OPERATIONS PHASE, AVERAGE YEAR CONDITION, BAGSVERD CREEK EFFLUENT DISCHARGE OPTION - MESOMIKENDA LAKE WATERSHED
CÔTÉ GOLD PROJECT

Parameter	Units	Aquatic Health Benchmark ^(a)	Human Health Benchmark ^(b)	MESOMIKENDA LAKE WATERSHED																							
				Bagsverd Lake				Unnamed Lake #1				Bagsverd Creek				Bagsverd Creek (Treated Effluent Discharge Mixing Point)				Neville Lake (Lower Basin, Mixing Zone)				Mesomikenda Lake (Upper Basin)			
				Med	Max	% > Aquatic Health Benchmark	% > Human Health Benchmark	Med	Max	% > Aquatic Health Benchmark	% > Human Health Benchmark	Med	Max	% > Aquatic Health Benchmark	% > Human Health Benchmark	Med	Max	% > Aquatic Health Benchmark	% > Human Health Benchmark	Med	Max	% > Aquatic Health Benchmark	% > Human Health Benchmark	Med	Max	% > Aquatic Health Benchmark	% > Human Health Benchmark
Aluminum	mg/L	0.1182	-	0.054	0.056	0%	-	0.055	0.074	0%	-	0.055	0.074	0%	-	0.055	0.11	0%	-	0.048	0.056	0%	-	0.046	0.046	0%	-
Ammonia (Total)	mg/L	6.89	-	0.107	0.120	0%	-	0.156	0.264	0%	-	0.15	0.26	0%	-	0.17	1.9	0%	-	0.073	0.44	0%	-	0.067	0.070	0%	-
Ammonia (Un-ionized)	mg/L	0.019	-	0.00016	0.00059	0%	-	0.00029	0.00145	0%	-	0.00027	0.0015	0%	-	0.00029	0.012	0%	-	0.00025	0.0023	0%	-	0.00011	0.00042	0%	-
Antimony	mg/L	0.02	0.006	0.0002956	0.000307	0%	0%	0.0003029	0.000408	0%	0%	0.00030	0.00041	0%	0%	0.0003029	0.00859	0%	2%	0.000276	0.0014	0%	0%	0.00030	0.00032	0%	0%
Arsenic	mg/L	0.005	0.01	0.0018	0.0018	0%	0%	0.0018	0.0024	0%	0%	0.0018	0.0024	0%	0%	0.0018	0.025	21%	11%	0.0016	0.0048	0%	0%	0.0016	0.0017	0%	0%
Barium	mg/L	1.0	1	0.0069	0.0071	0%	0%	0.0071	0.0096	0%	0%	0.0071	0.010	0%	0%	0.0071	0.035	0%	0%	0.0061	0.010	0%	0%	0.0058	0.0059	0%	0%
Boron	mg/L	1.5	5	0.0059	0.0061	0%	0%	0.0059	0.0080	0%	0%	0.0059	0.0080	0%	0%	0.0059	0.022	0%	0%	0.0053	0.0076	0%	0%	0.0050	0.0051	0%	0%
Cadmium	mg/L	0.000058	0.005	0.000023	0.000024	0%	0%	0.000024	0.000032	0%	0%	0.000024	0.000032	0%	0%	0.000024	0.00065	0.27%	0%	0.000021	0.000027	0%	0%	0.000020	0.000020	0%	0%
Calcium	mg/L	10.465	-	8.7	9.0	0%	-	8.9	12	22%	-	8.9	12	21%	-	8.9	161	33%	-	7.9	29	39%	-	8.2	8.4	0%	-
Chloride	mg/L	120	-	0.90	0.92	0%	-	0.99	1.4	0%	-	1.0	1.4	0%	-	1.0	7.0	0%	-	0.78	1.6	0%	-	0.74	0.75	0%	-
Cobalt	mg/L	0.0025	-	0.00031	0.00033	0%	-	0.00032	0.00043	0%	-	0.00032	0.00043	0%	-	0.00032	0.0013	0%	-	0.00028	0.00041	0%	-	0.00027	0.00027	0%	-
Copper	mg/L	0.005	-	0.0014	0.0014	0%	-	0.0016	0.0023	0%	-	0.0016	0.0023	0%	-	0.0017	0.012	12%	-	0.0012	0.0027	0%	-	0.0011	0.0011	0%	-
Cyanide (Total)	mg/L	-	-	0.0064	0.0080	0%	-	0.0112	0.0209	0%	-	0.0107	0.021	0%	-	0.0087	0.021	0%	-	0.0026	0.0035	0%	-	0.0016	0.0016	0%	-
Cyanide (Free)	mg/L	0.009784	0.2	0.0016	0.0020	0%	0%	0.0028081	0.005214	0%	0%	0.002687	0.00521	0%	0%	0.0022	0.0052	0%	0%	0.000712	0.00093	0%	0%	0.000432	0.00044	0%	0%
Iron	mg/L	0.369	-	0.20	0.21	0%	-	0.20	0.28	0%	-	0.20	0.28	0%	-	0.20	0.28	0%	-	0.18	0.18	0%	-	0.17	0.17	0%	-
Lead	mg/L	0.001	0.01	0.000060	0.000063	0%	0%	0.000061	0.000083	0%	0%	0.000061	0.000083	0%	0%	0.000061	0.00047	0%	0%	0.000055	0.00012	0%	0%	0.000053	0.000054	0%	0%
Magnesium	mg/L	2.003	-	1.6	1.7	0%	-	1.7	2.4	22%	-	1.7	2.4	21%	-	1.7	4.4	32%	-	1.4	1.8	0%	-	1.3	1.3	0%	-
Manganese	mg/L	0.7	-	0.068	0.071	0%	-	0.069	0.093	0%	-	0.069	0.093	0%	-	0.069	0.24	0%	-	0.061	0.085	0%	-	0.058	0.058	0%	-
Molybdenum	mg/L	0.073	-	0.0013	0.0013	0%	-	0.0015	0.0021	0%	-	0.0015	0.0021	0%	-	0.0015	0.015	0%	-	0.0011	0.0033	0%	-	0.0011	0.0011	0%	-
Nickel	mg/L	0.025	-	0.0018	0.0019	0%	-	0.0018	0.0025	0%	-	0.0018	0.0025	0%	-	0.0018	0.0032	0%	-	0.0016	0.0018	0%	-	0.0015	0.0015	0%	-
Nitrate	mg/L	13	10	0.07	0.07	0%	0%	0.073	0.098	0%	0%	0.073	0.098	0%	0%	0.073	6.6	0%	0%	0.078	1.36	0%	0%	0.11	0.12	0%	0%
Phosphorus (Total)	mg/L	0.035	-	0.016	0.016	0%	-	0.016	0.021	0%	-	0.016	0.021	0%	-	0.016	0.19	22%	-	0.014	0.048	18%	-	0.015	0.015	0%	-
Potassium	mg/L	373	-	0.47	0.48	0%	-	0.55	0.78	0%	-	0.54	0.78	0%	-	0.56	10	0%	-	0.40	1.8	0%	-	0.41	0.43	0%	-
Sodium	mg/L	1.3365	-	1.4	1.5	72%	-	1.7	2.5	83%	-	1.7	2.5	78%	-	1.8	3.8	78%	-	1.1	1.5	22%	-	1.0	1.0	0%	-
Strontium	mg/L	0.026	-	0.020	0.021	0%	-	0.021	0.028	7%	-	0.021	0.028	7%	-	0.021	0.26	27%	-	0.018	0.052	34%	-	0.018	0.019	0%	-
Sulphate	mg/L	218	-	4.2	4.3	0%	-	4.9	7.1	0%	-	4.9	7.1	0%	-	5.0	15	0%	-	3.4	5.0	0%	-	3.1	3.1	0%	-
Uranium	mg/L	0.015	0.02	0.0012	0.0012	0%	0%	0.0012	0.0016	0%	0%	0.0012	0.0016	0%	0%	0.0012	0.020	2%	0.27%	0.0011	0.0037	0%	0%	0.0011	0.0011	0%	0%
Vanadium	mg/L	0.006	-	0.0012	0.0012	0%	-	0.0012	0.0016	0%	-	0.0012	0.0016	0%	-	0.0012	0.0092	4%	-	0.0011	0.0022	0%	-	0.0010	0.0010	0%	-
Zinc	mg/L	0.032	-	0.010	0.011	0%	-	0.010	0.014	0%	-	0.010	0.014	0%	-	0.010	0.040	2%	-	0.009	0.013	0%	-	0.009	0.009	0%	-

Notes:

Med - Median Annual Concentration

Max - Maximum Annual Concentration

% > Aquatic Health Benchmark and % > Human Health Drinking Water Guideline - percentage of days during the climate year that the concentration is greater than the Aquatic Health Benchmark and Human Health Drinking Water Guideline, respectively.

0.001 - denotes concentrations that are greater than the Aquatic Health Benchmark.

0.001 - denotes concentrations that are greater than the Human Health Drinking Water Guideline.

(a) Aquatic Health Benchmark - The benchmark is equal to the most recent of the PWQO or CWQG (or the BCMOE guideline for parameters without a PWQO or CWQG) or the upper limit of background (95th percentile), whichever is higher (with the exception of cyanide, which has a site-specific guideline). If no guideline exists, then background was used as the benchmark.

(b) Human Health Drinking Water Guideline - The guideline is equal to the ODWS and CDWQG (where the same). For arsenic, the guideline is equal to the CDWQG. For nitrate, the benchmark is equal to the ODWS.

TABLE A4-ii
WATER QUALITY MODELING RESULTS: OPERATIONS PHASE, AVERAGE YEAR CONDITION, MESOMIKENDA LAKE DISCHARGE OPTION - MESOMIKENDA LAKE WATERSHED
CÔTÉ GOLD PROJECT

Parameter	Units	Aquatic Health Benchmark ^(a)	Human Health Drinking Water Guideline ^(b)	MESOMIKENDA LAKE WATERSHED																							
				Bagsverd Lake				Unnamed Lake #1				Bagsverd Creek				Neville Lake				Mesomikenda Lake (Upper Middle Basin, Mixing Zone)				Mesomikenda Lake (Upper Basin)			
				Med	Max	% > Aquatic Health Benchmark	% > Human Health Drinking Water Guideline	Med	Max	% > Aquatic Health Benchmark	% > Human Health Drinking Water Guideline	Med	Max	% > Aquatic Health Benchmark	% > Human Health Drinking Water Guideline	Med	Max	% > Aquatic Health Benchmark	% > Human Health Drinking Water Guideline	Med	Max	% > Aquatic Health Benchmark	% > Human Health Drinking Water Guideline	Med	Max	% > Aquatic Health Benchmark	% > Human Health Drinking Water Guideline
Aluminum	mg/L	0.1182	-	0.054	0.056	0%	-	0.055	0.074	0%	-	0.055	0.074	0%	-	0.048	0.051	0%	-	0.052	0.056	0%	-	0.046	0.046	0%	-
Ammonia (Total)	mg/L	6.89	-	0.11	0.12	0%	-	0.16	0.264	0%	-	0.15	0.3	0%	-	0.07	0.07	0%	-	0.235	0.336	0%	-	0.072	0.078	0%	-
Ammonia (Un-ionized)	mg/L	0.019	-	0.00016	0.00059	0%	-	0.00029	0.00145	0%	-	0.00027	0.001	0%	-	0.00011	0.0004	0%	-	0.000	0.002	0%	-	0.00011	0.00044	0%	-
Antimony	mg/L	0.02	0.006	0.00030	0.00031	0%	0%	0.00030	0.00041	0%	0%	0.00030	0.00041	0%	0%	0.0002595	0.00028	0%	0%	0.0010	0.0013	0%	0%	0.00032	0.00035	0%	0%
Arsenic	mg/L	0.005	0.01	0.0018	0.0018	0%	0%	0.0018	0.0024	0%	0%	0.0018	0.0024	0%	0%	0.0016	0.0017	0%	0%	0.0035	0.0045	0%	0%	0.0017	0.0017	0%	0%
Barium	mg/L	1.0	1	0.0069	0.0071	0%	0%	0.0071	0.0096	0%	0%	0.0071	0.010	0%	0%	0.006	0.006	0%	0%	0.0083	0.010	0%	0%	0.0059	0.0060	0%	0%
Boron	mg/L	1.5	5	0.0059	0.0061	0%	0%	0.0059	0.0080	0%	0%	0.0059	0.0080	0%	0%	0.0052	0.0055	0%	0%	0.0065	0.0074	0%	0%	0.0050	0.0051	0%	0%
Cadmium	mg/L	0.000058	0.005	0.000023	0.000024	0%	0%	0.000024	0.000032	0%	0%	0.000024	0.000032	0%	0%	0.000021	0.000022	0%	0%	0.000024	0.000027	0%	0%	0.000020	0.000020	0%	0%
Calcium	mg/L	10.465	-	8.7	9.0	0%	-	8.9	12	22%	-	8.9	12	21%	-	7.6	8.1	0%	-	20	27	100%	-	8.5	9.0	0%	-
Chloride	mg/L	120	-	0.90	0.92	0%	-	0.99	1.4	0%	-	1.0	1.4	0%	-	0.76	0.80	0%	-	1.3	1.5	0%	-	0.76	0.78	0%	-
Cobalt	mg/L	0.0025	-	0.00031	0.00033	0%	-	0.00032	0.00043	0%	-	0.00032	0.00043	0%	-	0.00028	0.00029	0%	-	0.00035	0.00040	0%	-	0.00027	0.00027	0%	-
Copper	mg/L	0.005	-	0.0014	0.0014	0%	-	0.0016	0.0023	0%	-	0.0016	0.0023	0%	-	0.0011	0.0012	0%	-	0.0020	0.0025	0%	-	0.0011	0.0012	0%	-
Cyanide (Total)	mg/L	-	-	0.0064	0.0080	0%	-	0.011	0.021	0%	-	0.011	0.021	0%	-	0.0028	0.0035	0%	-	0.0014	0.0014	0%	-	0.0016	0.0017	0%	-
Cyanide (Free)	mg/L	0.009784	0.2	0.0016	0.0020	0%	0%	0.0028	0.0052	0%	0%	0.0027	0.0052	0%	0%	0.00075	0.00094	0%	0%	0.00035	0.00036	0%	0%	0.00043	0.00044	0%	0%
Iron	mg/L	0.369	-	0.20	0.21	0%	-	0.20	0.28	0%	-	0.20	0.28	0%	-	0.18	0.19	0%	-	0.17	0.17	0%	-	0.17	0.17	0%	-
Lead	mg/L	0.001	0.01	0.000060	0.000063	0%	0%	0.000061	0.000083	0%	0%	0.000061	0.000083	0%	0%	0.000053	0.000057	0%	0%	0.000088	0.00011	0%	0%	0.000054	0.000055	0%	0%
Magnesium	mg/L	2.003	-	1.6	1.7	0%	-	1.7	2.4	22%	-	1.7	2.4	21%	-	1.4	1.5	0%	-	1.6	1.8	0%	-	1.3	1.4	0%	-
Manganese	mg/L	0.7	-	0.068	0.071	0%	-	0.069	0.093	0%	-	0.069	0.093	0%	-	0.060	0.064	0%	-	0.074	0.083	0%	-	0.058	0.059	0%	-
Molybdenum	mg/L	0.073	-	0.0013	0.0013	0%	-	0.0015	0.0021	0%	-	0.0015	0.002	0%	-	0.0011	0.0011	0%	-	0.0023	0.0029	0%	-	0.0011	0.0012	0%	-
Nickel	mg/L	0.025	-	0.0018	0.0019	0%	-	0.0018	0.0025	0%	-	0.0018	0.0025	0%	-	0.0016	0.0017	0%	-	0.0017	0.0018	0%	-	0.0015	0.0015	0%	-
Nitrate	mg/L	13	10	0.07	0.07	0%	0%	0.07	0.10	0%	0%	0.07	0.10	0%	0%	0.06	0.07	0%	0%	0.70	1.05	0%	0%	0.13	0.15	0%	0%
Phosphorus (Total)	mg/L	0.035	-	0.016	0.016	0%	-	0.016	0.021	0%	-	0.016	0.021	0%	-	0.014	0.015	0%	-	0.025	0.033	0%	-	0.014	0.015	0%	-
Potassium	mg/L	373	-	0.47	0.48	0%	-	0.55	0.78	0%	-	0.54	0.78	0%	-	0.4	0.4	0%	-	1.2	1.6	0%	-	0.43	0.46	0%	-
Sodium	mg/L	1.3365	-	1.4	1.5	72%	-	1.7	2.5	83%	-	1.7	2.5	78%	-	1.1	1	0%	-	1.2	1.4	12%	-	1.0	1.0	0%	-
Strontium	mg/L	0.026	-	0.020	0.021	0%	-	0.021	0.028	7%	-	0.021	0.028	7%	-	0.018	0.019	0%	-	0.038	0.049	100%	-	0.019	0.020	0%	-
Sulphate	mg/L	218	-	4.2	4.3	0%	-	4.9	7.1	0%	-	4.9	7.1	0%	-	3	4	0%	-	4.07	4.71	0%	-	3.1	3.2	0%	-
Uranium	mg/L	0.015	0.02	0.0012	0.0012	0%	0%	0.0012	0.0016	0%	0%	0.0012	0.0016	0%	0%	0.0010	0.0011	0%	0%	0.0026	0.0035	0%	0%	0.0012	0.0012	0%	0%
Vanadium	mg/L	0.006	-	0.0012	0.0012	0%	-	0.0012	0.0016	0%	-	0.0012	0.0016	0%	-	0.0010	0.0011	0%	-	0.0017	0.0021	0%	-	0.0011	0.0011	0%	-
Zinc	mg/L	0.032	-	0.010	0.011	0%	-	0.010	0.014	0%	-	0.010	0.014	0%	-	0.009	0.010	0%	-	0.011	0.013	0%	-	0.009	0.009	0%	-

Notes:

Med - Median Annual Concentration

Max - Maximum Annual Concentration

% > Aquatic Health Benchmark and % > Human Health Drinking Water Guideline - percentage of days during the climate year that the concentration is greater than the Aquatic Health Benchmark and Human Health Drinking Water Guideline, respectively.

0.001 - denotes concentrations that are greater than the Aquatic Health Benchmark.

0.001 - denotes concentrations that are greater than the Human Health Drinking Water Guideline.

(a) Aquatic Health Benchmark - The benchmark is equal to the most recent of the PWQO or CWQG (or the BCMOE guideline for parameters without a PWQO or CWQG) or the upper limit of background (95th percentile), whichever is higher (with the exception of cyanide, which has a site-specific guideline). If no guideline exists, then background was used as the benchmark.

(b) Human Health Drinking Water Guideline - The guideline is equal to the ODWS and CDWQG (where the same). For arsenic, the guideline is equal to the CDWQG. For nitrate, the benchmark is equal to the ODWS.

TABLE A5-i
WATER QUALITY MODELING RESULTS: OPERATIONS PHASE, 1:25-YEAR DRY CONDITION, BAGSVRD CREEK EFFLUENT DISCHARGE OPTION - MESOMIKENDA LAKE WATERSHED
CÔTÉ GOLD PROJECT

Parameter	Units	Aquatic Health Benchmark ^(a)	Human Health Drinking Water Guideline ^(b)	MESOMIKENDA LAKE WATERSHED																							
				Bagsverd Lake				Unnamed Lake #1				Bagsverd Creek (BL-B)				Bagsverd Creek (Treated Effluent Discharge Mixing Point)				Neville Lake (Lower Basin, Mixing Zone)				Mesomikenda Lake (Upper Basin)			
				Med	Max	% > Aquatic Health Benchmark	% > Human Health Drinking Water Guideline	Med	Max	% > Aquatic Health Benchmark	% > Human Health Drinking Water Guideline	Med	Max	% > Aquatic Health Benchmark	% > Human Health Drinking Water Guideline	Med	Max	% > Aquatic Health Benchmark	% > Human Health Drinking Water Guideline	Med	Max	% > Aquatic Health Benchmark	% > Human Health Drinking Water Guideline	Med	Max	% > Aquatic Health Benchmark	% > Human Health Drinking Water Guideline
Aluminum	mg/L	0.1182	-	0.054	0.060	0%	-	0.057	0.11	0%	-	0.054	0.10	0%	-	0.054	0.32	1%	-	0.048	0.052	0%	-	0.046	0.047	0%	-
Ammonia (Total)	mg/L	6.89	-	0.12	0.13	0%	-	0.18	0.42	0%	-	0.14	0.40	0%	-	0.14	1.3	0%	-	0.069	0.079	0%	-	0.066	0.076	0%	-
Ammonia (Un-ionized)	mg/L	0.019	-	0.00020	0.00074	0%	-	0.00037	0.0023	0%	-	0.00018	0.0022	0%	-	0.00018	0.0032	0%	-	0.00010	0.00044	0%	-	0.00011	0.00044	0%	-
Antimony	mg/L	0.02	0.006	0.00030	0.000327	0%	0%	0.0003119	0.000584	0%	0%	0.00030	0.0005705	0%	0%	0.00030	0.0018	0%	0%	0.0002625	0.000281	0%	0%	0.0003069	0.000352	0%	0%
Arsenic	mg/L	0.005	0.01	0.0018	0.0019	0%	0%	0.0018	0.0034	0%	0%	0.0018	0.0033	0%	0%	0.0018	0.011	0.27%	0.27%	0.0016	0.0017	0%	0%	0.0017	0.0018	0%	0%
Barium	mg/L	1.0	1	0.0069	0.0076	0%	0%	0.0073	0.014	0%	0%	0.0070	0.014	0%	0%	0.0070	0.042	0%	0%	0.0060	0.0065	0%	0%	0.0059	0.0061	0%	0%
Boron	mg/L	1.5	5	0.0059	0.0065	0%	0%	0.0061	0.011	0%	0%	0.0059	0.011	0%	0%	0.0059	0.035	0%	0%	0.0052	0.0056	0%	0%	0.0051	0.0052	0%	0%
Cadmium	mg/L	0.000058	0.005	0.000024	0.000026	0%	0%	0.000025	0.000045	0%	0%	0.000024	0.000044	0%	0%	0.000023	0.00014	0.27%	0%	0.000021	0.000022	0%	0%	0.000020	0.000020	0%	0%
Calcium	mg/L	10.465	-	8.7	9.6	0%	-	9.2	17	35%	-	8.8	17	18%	-	8.8	53	18%	-	7.7	8.2	0%	-	8.3	9.1	0%	-
Chloride	mg/L	120	-	0.90	1.00	0%	-	1.0	2.0	0%	-	1.0	1.9	0%	-	1.0	6.1	0%	-	0.8	0.8	0%	-	0.76	0.79	0%	-
Cobalt	mg/L	0.0025	-	0.00032	0.00035	0%	-	0.00033	0.00062	0%	-	0.00032	0.00061	0%	-	0.00032	0.0019	0%	-	0.00028	0.00030	0%	-	0.00027	0.00028	0%	-
Copper	mg/L	0.005	-	0.0014	0.0016	0%	-	0.0017	0.0035	0%	-	0.0015	0.0034	0%	-	0.0015	0.011	0.27%	-	0.0011	0.0012	0%	-	0.0011	0.0012	0%	-
Cyanide (Total)	mg/L	-	-	0.0075	0.0084	0%	-	0.014	0.034	0%	-	0.0094	0.033	0%	-	0.0094	0.10	0%	-	0.0028	0.0037	0%	-	0.0017	0.0017	0%	-
Cyanide (Free)	mg/L	0.009784	0.2	0.0019	0.002103	0%	0%	0.0034	0.0085	0%	0%	0.0023	0.0081	0%	0%	0.0023	0.0096	0%	0%	0.0007836	0.00098	0%	0%	0.00044	0.000446	0%	0%
Iron	mg/L	0.369	-	0.20	0.22	0%	-	0.21	0.39	3%	-	0.20	0.39	1%	-	0.20	1.2	2%	-	0.18	0.19	0%	-	0.17	0.17	0%	-
Lead	mg/L	0.001	0.01	0.000061	0.000067	0%	0%	0.000063	0.00012	0%	0%	0.000061	0.00012	0%	0%	0.000061	0.00036	0%	0%	0.000054	0.000058	0%	0%	0.000054	0.000056	0%	0%
Magnesium	mg/L	2.003	-	1.6	1.8	0%	-	1.8	3.4	35%	-	1.7	3.3	18%	-	1.7	10	18%	-	1.4	1.5	0%	-	1.4	1.4	0%	-
Manganese	mg/L	0.7	-	0.068	0.075	0%	-	0.071	0.13	0%	-	0.068	0.13	0%	-	0.068	0.406	0%	-	0.060	0.065	0%	-	0.059	0.060	0%	-
Molybdenum	mg/L	0.073	-	0.0013	0.0015	0%	-	0.0015	0.0030	0%	-	0.0014	0.0030	0%	-	0.0014	0.009	0%	-	0.0011	0.0012	0%	-	0.0011	0.0012	0%	-
Nickel	mg/L	0.025	-	0.0018	0.0020	0%	-	0.0019	0.0036	0%	-	0.0018	0.0035	0%	-	0.0018	0.0110	0%	-	0.0016	0.0017	0%	-	0.0015	0.0015	0%	-
Nitrate	mg/L	13	10	0.07	0.08	0%	0%	0.075	0.14	0%	0%	0.072	0.14	0%	0%	0.072	0.43	0%	0%	0.065	0.069	0%	0%	0.11	0.14	0%	0%
Phosphorus (Total)	mg/L	0.035	-	0.016	0.017	0%	-	0.016	0.031	0%	-	0.016	0.030	0%	-	0.016	0.094	1%	-	0.014	0.015	0%	-	0.014	0.015	0%	-
Potassium	mg/L	373	-	0.48	0.52	0%	-	0.57	1.16	0%	-	0.51	1.1	0%	-	0.51	3.6	0%	-	0.38	0.42	0%	-	0.42	0.47	0%	-
Sodium	mg/L	1.3365	-	1.5	1.6	85%	-	1.8	3.8	90%	-	1.6	3.7	70%	-	1.6	12	69%	-	1.1	1.2	0%	-	1.0	1.0	0%	-
Strontium	mg/L	0.026	-	0.020	0.022	0%	-	0.021	0.040	29%	-	0.021	0.039	14%	-	0.021	0.12	14%	-	0.018	0.019	0%	-	0.019	0.020	0%	-
Sulphate	mg/L	218	-	4.3	4.7	0%	-	5.2	11	0%	-	4.6	10	0%	-	4.6	32	0%	-	3.4	3.7	0%	-	3.1	3.2	0%	-
Uranium	mg/L	0.015	0.02	0.0012	0.0013	0%	0%	0.0013	0.0024	0%	0%	0.0012	0.0023	0%	0%	0.0012	0.0072	0%	0%	0.0011	0.0011	0%	0%	0.0011	0.0012	0%	0%
Vanadium	mg/L	0.006	-	0.0012	0.0013	0%	-	0.0012	0.0023	0%	-	0.0012	0.0022	0%	-	0.0012	0.0070	0.27%	-	0.0010	0.0011	0%	-	0.0011	0.0011	0%	-
Zinc	mg/L	0.032	-	0.010	0.011	0%	-	0.011	0.020	0%	-	0.010	0.019	0%	-	0.010	0.061	0.27%	-	0.0091	0.010	0%	-	0.0089	0.0091	0%	-

Notes:

Med - Median Annual Concentration

Max - Maximum Annual Concentration

% > Aquatic Health Benchmark and % > Human Health Drinking Water Guideline - percentage of days during the climate year that the concentration is greater than the Aquatic Health Benchmark and Human Health Drinking Water Guideline, respectively.

0.001 - denotes concentrations that are greater than the Aquatic Health Benchmark.

0.001 - denotes concentrations that are greater than the Human Health Drinking Water Guideline.

(a) Aquatic Health Benchmark - The benchmark is equal to the most recent of the PWQO or CWQG (or the BCMOE guideline for parameters without a PWQO or CWQG) or the upper limit of background (95th percentile), whichever is higher (with the exception of cyanide, which has a site-specific guideline). If no guideline exists, then background was used as the benchmark.

(b) Human Health Drinking Water Guideline - The guideline is equal to the ODWS and CDWQG (where the same). For arsenic, the guideline is equal to the CDWQG. For nitrate, the benchmark is equal to the ODWS.

TABLE A5-ii
WATER QUALITY MODELING RESULTS: OPERATIONS PHASE, 1:25-YEAR DRY CONDITION, MESOMIKENDA LAKE DISCHARGE OPTION - MESOMIKENDA LAKE WATERSHED
CÔTÉ GOLD PROJECT

Parameter	Units	Aquatic Health Benchmark ^(a)	Human Health Drinking Water Guideline ^(b)	MESOMIKENDA LAKE WATERSHED																							
				Bagsverd Lake				Unnamed Lake #1				Bagsverd Creek (BL-B)				Neville Lake				Mesomikenda Lake (Upper Middle Basin, Mixing Zone)				Mesomikenda Lake (Upper Basin)			
				Med	Max	% > Aquatic Health Benchmark	% > Human Health Drinking Water Guideline	Med	Max	% > Aquatic Health Benchmark	% > Human Health Drinking Water Guideline	Med	Max	% > Aquatic Health Benchmark	% > Human Health Drinking Water Guideline	Med	Max	% > Aquatic Health Benchmark	% > Human Health Drinking Water Guideline	Med	Max	% > Aquatic Health Benchmark	% > Human Health Drinking Water Guideline	Med	Max	% > Aquatic Health Benchmark	% > Human Health Drinking Water Guideline
Aluminum	mg/L	0.1182	-	0.054	0.060	0%	-	0.057	0.105	0%	-	0.054	0.103	0%	-	0.048	0.053	0%	-	0.055	0.060	0%	-	0.047	0.047	0%	-
Ammonia (Total)	mg/L	6.89	-	0.12	0.13	0%	-	0.18	0.417	0%	-	0.14	0.4	0%	-	0.07	0.08	0%	-	0.201	0.361	0%	-	0.077	0.085	0%	-
Ammonia (Un-ionized)	mg/L	0.019	-	0.00020	0.00074	0%	-	0.00037	0.0023	0%	-	0.00018	0.002	0%	-	0.00010	0.0005	0%	-	0.000	0.001	0%	-	0.00013	0.00052	0%	-
Antimony	mg/L	0.02	0.006	0.00030	0.00033	0%	0%	0.00031	0.00058	0%	0%	0.00030	0.00057	0%	0%	0.0002621	0.00029	0%	0%	0.0009	0.0016	0%	0%	0.00035	0.00039	0%	0%
Arsenic	mg/L	0.005	0.01	0.0018	0.0019	0%	0%	0.0018	0.0034	0%	0%	0.0018	0.0033	0%	0%	0.0016	0.0017	0%	0%	0.0034	0.0054	10%	0%	0.0018	0.0019	0%	0%
Barium	mg/L	1.0	1	0.0069	0.0076	0%	0%	0.0073	0.014	0%	0%	0.0070	0.014	0%	0%	0.006	0.007	0%	0%	0.0085	0.011	0%	0%	0.0061	0.0062	0%	0%
Boron	mg/L	1.5	5	0.0059	0.0065	0%	0%	0.0061	0.011	0%	0%	0.0059	0.011	0%	0%	0.0052	0.0057	0%	0%	0.0068	0.0082	0%	0%	0.0052	0.0053	0%	0%
Cadmium	mg/L	0.000058	0.005	0.000024	0.000026	0%	0%	0.000025	0.000045	0%	0%	0.000024	0.000044	0%	0%	0.000021	0.000023	0%	0%	0.000025	0.000029	0%	0%	0.000021	0.000021	0%	0%
Calcium	mg/L	10.465	-	8.7	9.6	0%	-	9.2	17	35%	-	9	17	18%	-	8	8	0%	-	20	33	100%	-	9.2	9.8	0%	-
Chloride	mg/L	120	-	0.90	1.00	0%	-	1.02	2.0	0%	-	1.0	2	0%	-	0.8	0.8	0%	-	1.3	1.8	0%	-	0.79	0.82	0%	-
Cobalt	mg/L	0.0025	-	0.00032	0.00035	0%	-	0.00033	0.00062	0%	-	0.00032	0.00061	0%	-	0.00028	0.00031	0%	-	0.00037	0.00045	0%	-	0.00028	0.00028	0%	-
Copper	mg/L	0.005	-	0.0014	0.0016	0%	-	0.0017	0.0035	0%	-	0.0015	0.0034	0%	-	0.0011	0.0013	0%	-	0.0020	0.0029	0%	-	0.0012	0.0012	0%	-
Cyanide (Total)	mg/L	-	-	0.0075	0.0084	0%	-	0.014	0.034	0%	-	0.009	0.033	0%	-	0.0029	0.0037	0%	-	0.0014	0.0016	0%	-	0.0017	0.0017	0%	-
Cyanide (Free)	mg/L	0.009784	0.2	0.0019	0.0021	0%	0%	0.0034	0.0085	0%	0%	0.0023	0.0081	0%	0%	0.00080	0.00098	0%	0%	0.00036	0.00039	0%	0%	0.00044	0.00045	0%	0%
Iron	mg/L	0.369	-	0.20	0.22	0%	-	0.21	0.39	3%	-	0.20	0.39	1%	-	0.18	0.19	0%	-	0.18	0.19	0%	-	0.17	0.17	0%	-
Lead	mg/L	0.001	0.01	0.000061	0.000067	0%	0%	0.000063	0.000118	0%	0%	0.000061	0.000115	0%	0%	0.000054	0.000059	0%	0%	0.000088	0.00012	0%	0%	0.000057	0.000058	0%	0%
Magnesium	mg/L	2.003	-	1.6	1.8	0%	-	1.8	3.4	35%	-	1.7	3.3	18%	-	1.4	1.6	0%	-	1.7	1.9	0%	-	1.4	1.4	0%	-
Manganese	mg/L	0.7	-	0.068	0.075	0%	-	0.071	0.13	0%	-	0.068	0.129	0%	-	0.060	0.066	0%	-	0.077	0.092	0%	-	0.060	0.061	0%	-
Molybdenum	mg/L	0.073	-	0.0013	0.0015	0%	-	0.0015	0.0030	0%	-	0.0014	0.003	0%	-	0.0011	0.0012	0%	-	0.0022	0.0033	0%	-	0.0012	0.0012	0%	-
Nickel	mg/L	0.025	-	0.0018	0.0020	0%	-	0.0019	0.0036	0%	-	0.0018	0.0035	0%	-	0.0016	0.0017	0%	-	0.0018	0.0019	0%	-	0.0015	0.0015	0%	-
Nitrate	mg/L	13	10	0.07	0.08	0%	0%	0.08	0.14	0%	0%	0.07	0.14	0%	0%	0.06	0.07	0%	0%	0.58	1.13	0%	0%	0.15	0.17	0%	0%
Phosphorus (Total)	mg/L	0.035	-	0.016	0.017	0%	-	0.016	0.031	0%	-	0.016	0.030	0%	-	0.014	0.015	0%	-	0.022	0.031	0%	-	0.015	0.015	0%	-
Potassium	mg/L	373	-	0.48	0.52	0%	-	0.57	1.16	0%	-	0.51	1.13	0%	-	0.4	0.4	0%	-	1.1	2.0	0%	-	0.47	0.51	0%	-
Sodium	mg/L	1.3365	-	1.5	1.6	85%	-	1.8	3.8	90%	-	1.6	3.7	70%	-	1.1	1	0%	-	1.3	1.5	28%	-	1.1	1.1	0%	-
Strontium	mg/L	0.026	-	0.020	0.022	0%	-	0.021	0.040	29%	-	0.021	0.039	14%	-	0.018	0.020	0%	-	0.037	0.058	100%	-	0.020	0.021	0%	-
Sulphate	mg/L	218	-	4.3	4.7	0%	-	5.2	10.7	0%	-	4.6	10.4	0%	-	3	4	0%	-	4.2	5.2	0%	-	3.2	3.2	0%	-
Uranium	mg/L	0.015	0.02	0.0012	0.0013	0%	0%	0.0013	0.0024	0%	0%	0.0012	0.0023	0%	0%	0.0010	0.0011	0%	0%	0.0026	0.0042	0%	0%	0.0012	0.0013	0%	0%
Vanadium	mg/L	0.006	-	0.0012	0.0013	0%	-	0.0012	0.0023	0%	-	0.0012	0.0022	0%	-	0.0010	0.0011	0%	-	0.0017	0.0024	0%	-	0.0011	0.0011	0%	-
Zinc	mg/L	0.032	-	0.010	0.011	0%	-	0.011	0.020	0%	-	0.010	0.019	0%	-	0.009	0.010	0%	-	0.012	0.014	0%	-	0.009	0.009	0%	-

Notes:

Med - Median Annual Concentration

Max - Maximum Annual Concentration

% > Aquatic Health Benchmark and % > Human Health Drinking Water Guideline - percentage of days during the climate year that the concentration is greater than the Aquatic Health Benchmark and Human Health Drinking Water Guideline, respectively.

0.001 - denotes concentrations that are greater than the Aquatic Health Benchmark.

0.001 - denotes concentrations that are greater than the Human Health Drinking Water Guideline.

(a) Aquatic Health Benchmark - The benchmark is equal to the most recent of the PWQO or CWQG (or the BCMOE guideline for parameters without a PWQO or CWQG) or the upper limit of background (95th percentile), whichever is higher (with the exception of cyanide, which has a site-specific guideline). If no guideline exists, then background was used as the benchmark.

(b) Human Health Drinking Water Guideline - The guideline is equal to the ODWS and CDWQG (where the same). For arsenic, the guideline is equal to the CDWQG. For nitrate, the benchmark is equal to the ODWS.

TABLE A6-i
WATER QUALITY MODELING RESULTS: OPERATIONS PHASE, 1:25-YEAR WET CONDITION, BAGSVERD CREEK EFFLUENT DISCHARGE OPTION - MESOMIKENDA LAKE WATERSHED
CÔTÉ GOLD PROJECT

Parameter	Units	Aquatic Health Benchmark ^(a)	Human Health Drinking Water Guideline ^(b)	MESOMIKENDA LAKE WATERSHED																							
				Bagsverd Lake				Unnamed Lake #1				Bagsverd Creek (BL-B)				Bagsverd Creek (Treated Effluent Discharge Mixing Point)				Neville Lake (Lower Basin, Mixing Zone)				Mesomikenda Lake (Upper Basin)			
				Med	Max	% > Aquatic Health Benchmark	% > Human Health Drinking Water Guideline	Med	Max	% > Aquatic Health Benchmark	% > Human Health Drinking Water Guideline	Med	Max	% > Aquatic Health Benchmark	% > Human Health Drinking Water Guideline	Med	Max	% > Aquatic Health Benchmark	% > Human Health Drinking Water Guideline	Med	Max	% > Aquatic Health Benchmark	% > Human Health Drinking Water Guideline	Med	Max	% > Aquatic Health Benchmark	% > Human Health Drinking Water Guideline
Aluminum	mg/L	0.1182	-	0.053	0.055	0%	-	0.053	0.075	0%	-	0.053	0.075	0%	-	0.056	0.17	0.27%	-	0.048	0.056	0%	-	0.046	0.047	0%	-
Ammonia (Total)	mg/L	6.89	-	0.096	0.12	0%	-	0.12	0.28	0%	-	0.11	0.28	0%	-	0.20	1.9	0%	-	0.071	0.48	0%	-	0.069	0.075	0%	-
Ammonia (Un-ionized)	mg/L	0.019	-	0.00016	0.00059	0%	-	0.00028	0.0015	0%	-	0.00023	0.0015	0%	-	0.00031	0.012	0%	-	0.00023	0.0030	0%	-	0.00012	0.00046	0%	-
Antimony	mg/L	0.02	0.006	0.000292	0.000303	0%	0%	0.000292	0.0004161	0%	0%	0.00029	0.00041	0%	0%	0.000314	0.0067	0%	1%	0.0002624	0.0018	0%	0%	0.0003188	0.000339	0%	0%
Arsenic	mg/L	0.005	0.01	0.0017	0.0018	0%	0%	0.0017	0.0024	0%	0%	0.0017	0.0024	0%	0%	0.0018	0.019	32%	15%	0.0016	0.0056	2%	0%	0.0017	0.0017	0%	0%
Barium	mg/L	1.0	1	0.0068	0.0070	0%	0%	0.0068	0.0098	0%	0%	0.0067	0.010	0%	0%	0.0074	0.034	0%	0%	0.0060	0.011	0%	0%	0.0060	0.0061	0%	0%
Boron	mg/L	1.5	5	0.0058	0.0060	0%	0%	0.0058	0.0081	0%	0%	0.0057	0.0081	0%	0%	0.0061	0.024	0%	0%	0.0052	0.0081	0%	0%	0.0051	0.0052	0%	0%
Cadmium	mg/L	0.000058	0.005	0.000023	0.000024	0%	0%	0.000023	0.000033	0%	0%	0.000023	0.000032	0%	0%	0.000025	0.000086	0.27%	0%	0.000021	0.000028	0%	0%	0.000020	0.000021	0%	0%
Calcium	mg/L	10.465	-	8.6	8.9	0%	-	8.6	12	12%	-	8.4	12	11%	-	9.3	125	39%	-	7.6	35	39%	-	8.5	8.9	0%	-
Chloride	mg/L	120	-	0.88	0.91	0%	-	0.89	1.4	0%	-	0.87	1.4	0%	-	1.0	5.9	0%	-	0.76	1.8	0%	-	0.76	0.78	0%	-
Cobalt	mg/L	0.0025	-	0.00031	0.00032	0%	-	0.00031	0.00044	0%	-	0.00031	0.00044	0%	-	0.00033	0.0013	0%	-	0.00028	0.00044	0%	-	0.00027	0.00028	0%	-
Copper	mg/L	0.005	-	0.0014	0.0014	0%	-	0.0014	0.0024	0%	-	0.0014	0.0024	0%	-	0.0018	0.010	17%	-	0.0011	0.0030	0%	-	0.0011	0.0012	0%	-
Cyanide (Total)	mg/L	-	-	0.0056	0.0081	0%	-	0.0080	0.022	0%	-	0.0071	0.022	0%	-	0.0057	0.033	0%	-	0.0020	0.0037	0%	-	0.0017	0.0017	0%	-
Cyanide (Free)	mg/L	0.009784	0.2	0.0014	0.0020	0%	0%	0.0020	0.0055	0%	0%	0.0018	0.0055	0%	0%	0.0014	0.0083	0%	0%	0.0005624	0.0010	0%	0%	0.00044	0.000452	0%	0%
Iron	mg/L	0.369	-	0.20	0.21	0%	-	0.20	0.28	0%	-	0.20	0.28	0%	-	0.19	0.50	0.27%	-	0.17	0.18	0%	-	0.17	0.17	0%	-
Lead	mg/L	0.001	0.01	0.000060	0.000062	0%	0%	0.000060	0.000084	0%	0%	0.000059	0.000084	0%	0%	0.000064	0.00039	0%	0%	0.000053	0.00013	0%	0%	0.000054	0.000056	0%	0%
Magnesium	mg/L	2.003	-	1.6	1.7	0%	-	1.6	2.4	13%	-	1.6	2.4	12%	-	1.8	6.1	35%	-	1.4	1.9	0%	-	1.4	1.4	0%	-
Manganese	mg/L	0.7	-	0.067	0.070	0%	-	0.067	0.094	0%	-	0.066	0.094	0%	-	0.071	0.27	0%	-	0.060	0.090	0%	-	0.059	0.060	0%	-
Molybdenum	mg/L	0.073	-	0.0013	0.0013	0%	-	0.0013	0.0021	0%	-	0.0013	0.0021	0%	-	0.0016	0.012	0%	-	0.0011	0.0036	0%	-	0.0011	0.0012	0%	-
Nickel	mg/L	0.025	-	0.0018	0.0018	0%	-	0.0018	0.0025	0%	-	0.0017	0.0025	0%	-	0.0019	0.0056	0%	-	0.0016	0.0018	0%	-	0.0015	0.0015	0%	-
Nitrate	mg/L	13	10	0.07	0.07	0%	0%	0.07	0.10	0%	0%	0.070	0.10	0%	0%	0.08	6.08	0%	0%	0.06	1.50	0%	0%	0.12	0.14	0%	0%
Phosphorus (Total)	mg/L	0.035	-	0.016	0.016	0%	-	0.016	0.022	0%	-	0.015	0.022	0%	-	0.016	0.20	35%	-	0.014	0.057	19%	-	0.015	0.016	0%	-
Potassium	mg/L	373	-	0.45	0.48	0%	-	0.47	0.80	0%	-	0.46	0.80	0%	-	0.60	7.96	0%	-	0.38	2.1	0%	-	0.43	0.45	0%	-
Sodium	mg/L	1.3365	-	1.4	1.5	59%	-	1.5	2.6	75%	-	1.4	2.6	64%	-	1.8	6.0	69%	-	1.1	1.5	14%	-	1.0	1.0	0%	-
Strontium	mg/L	0.026	-	0.020	0.021	0%	-	0.020	0.029	6%	-	0.020	0.028	5%	-	0.022	0.20	38%	-	0.018	0.061	38%	-	0.019	0.020	0%	-
Sulphate	mg/L	218	-	4.0	4.3	0%	-	4.2	7.3	0%	-	4.1	7.3	0%	-	5.4	19	0%	-	3.4	5.2	0%	-	3.1	3.2	0%	-
Uranium	mg/L	0.015	0.02	0.0012	0.0012	0%	0%	0.0012	0.0017	0%	0%	0.0012	0.0017	0%	0%	0.0013	0.016	0%	0%	0.0010	0.0044	0%	0%	0.0012	0.0012	0%	0%
Vanadium	mg/L	0.006	-	0.0012	0.0012	0%	-	0.0012	0.0016	0%	-	0.0011	0.0016	0%	-	0.0012	0.0074	2%	-	0.0010	0.0025	0%	-	0.0011	0.0011	0%	-
Zinc	mg/L	0.032	-	0.010	0.011	0%	-	0.010	0.014	0%	-	0.010	0.014	0%	-	0.011	0.043	0%	-	0.009	0.014	0%	-	0.009	0.009	0%	-

Notes:

Med - Median Annual Concentration

Max - Maximum Annual Concentration

% > Aquatic Health Benchmark and % > Human Health Drinking Water Guideline - percentage of days during the climate year that the concentration is greater than the Aquatic Health Benchmark and Human Health Drinking Water Guideline, respectively.

0.001 - denotes concentrations that are greater than the Aquatic Health Benchmark.

0.001 - denotes concentrations that are greater than the Human Health Drinking Water Guideline.

(a) Aquatic Health Benchmark - The benchmark is equal to the most recent of the PWQO or CWQG (or the BCMOE guideline for parameters without a PWQO or CWQG) or the upper limit of background (95th percentile), whichever is higher (with the exception of cyanide, which has a site-specific guideline). If no guideline exists, then background was used as the benchmark.

(b) Human Health Drinking Water Guideline - The guideline is equal to the ODWS and CDWQG (where the same). For arsenic, the guideline is equal to the CDWQG. For nitrate, the benchmark is equal to the ODWS.

TABLE A6-ii
WATER QUALITY MODELING RESULTS: OPERATIONS PHASE, 1:25-YEAR WET CONDITION, MESOMIKENDA LAKE DISCHARGE OPTION - MESOMIKENDA LAKE WATERSHED
CÔTÉ GOLD PROJECT

Parameter	Units	Aquatic Health Benchmark ^(a)	Human Health Drinking Water Guideline ^(b)	MESOMIKENDA LAKE WATERSHED																							
				Bagsverd Lake				Unnamed Lake #1				Bagsverd Creek (BL-B)				Neville Lake				Mesomikenda Lake (Upper Middle Basin, Mixing Zone)				Mesomikenda Lake (Upper Basin)			
				Med	Max	% > Aquatic Health Benchmark	% > Human Health Drinking Water Guideline	Med	Max	% > Aquatic Health Benchmark	% > Human Health Drinking Water Guideline	Med	Max	% > Aquatic Health Benchmark	% > Human Health Drinking Water Guideline	Med	Max	% > Aquatic Health Benchmark	% > Human Health Drinking Water Guideline	Med	Max	% > Aquatic Health Benchmark	% > Human Health Drinking Water Guideline	Med	Max	% > Aquatic Health Benchmark	% > Human Health Drinking Water Guideline
Aluminum	mg/L	0.1182	-	0.053	0.055	0%	-	0.053	0.075	0%	-	0.053	0.075	0%	-	0.048	0.050	0%	-	0.055	0.065	0%	-	0.047	0.047	0%	-
Ammonia (Total)	mg/L	6.89	-	0.10	0.12	0%	-	0.12	0.275	0%	-	0.11	0.3	0%	-	0.06	0.08	0%	-	0.262	0.516	0%	-	0.071	0.082	0%	-
Ammonia (Un-ionized)	mg/L	0.019	-	0.00016	0.00059	0%	-	0.00028	0.00155	0%	-	0.00023	0.002	0%	-	0.00011	0.0004	0%	-	0.001	0.003	0%	-	0.00011	0.00044	0%	-
Antimony	mg/L	0.02	0.006	0.00029	0.00030	0%	0%	0.00029	0.00042	0%	0%	0.00029	0.00041	0%	0%	0.0002597	0.00027	0%	0%	0.0012	0.0021	0%	0%	0.00033	0.00037	0%	0%
Arsenic	mg/L	0.005	0.01	0.0017	0.0018	0%	0%	0.0017	0.0024	0%	0%	0.0017	0.0024	0%	0%	0.0016	0.0016	0%	0%	0.0041	0.0067	31%	0%	0.0017	0.0018	0%	0%
Barium	mg/L	1.0	1	0.0068	0.0070	0%	0%	0.0068	0.0098	0%	0%	0.0067	0.010	0%	0%	0.006	0.006	0%	0%	0.0092	0.013	0%	0%	0.0060	0.0062	0%	0%
Boron	mg/L	1.5	5	0.0058	0.0060	0%	0%	0.0058	0.0081	0%	0%	0.0057	0.0081	0%	0%	0.0052	0.0055	0%	0%	0.0072	0.0094	0%	0%	0.0052	0.0053	0%	0%
Cadmium	mg/L	0.000058	0.005	0.000023	0.000024	0%	0%	0.000023	0.000033	0%	0%	0.000023	0.000032	0%	0%	0.000021	0.000022	0%	0%	0.000026	0.000032	0%	0%	0.000020	0.000021	0%	0%
Calcium	mg/L	10.465	-	8.6	8.9	0%	-	8.6	12	12%	-	8	12	11%	-	8	8	0%	-	24	41	100%	-	8.7	9.4	0%	-
Chloride	mg/L	120	-	0.88	0.91	0%	-	0.89	1.4	0%	-	0.9	1	0%	-	0.8	0.8	0%	-	1.4	2.1	0%	-	0.77	0.80	0%	-
Cobalt	mg/L	0.0025	-	0.00031	0.00032	0%	-	0.00031	0.00044	0%	-	0.00031	0.00044	0%	-	0.00028	0.00029	0%	-	0.00039	0.00051	0%	-	0.00028	0.00028	0%	-
Copper	mg/L	0.005	-	0.0014	0.0014	0%	-	0.0014	0.0024	0%	-	0.0014	0.0024	0%	-	0.0011	0.0012	0%	-	0.0023	0.0035	0%	-	0.0011	0.0012	0%	-
Cyanide (Total)	mg/L	-	-	0.0056	0.0081	0%	-	0.008	0.022	0%	-	0.007	0.022	0%	-	0.0021	0.0037	0%	-	0.0014	0.0014	0%	-	0.0017	0.0017	0%	-
Cyanide (Free)	mg/L	0.009784	0.2	0.0014	0.0020	0%	0%	0.0020	0.0055	0%	0%	0.0018	0.0055	0%	0%	0.00059	0.00100	0%	0%	0.00035	0.00036	0%	0%	0.00044	0.00045	0%	0%
Iron	mg/L	0.369	-	0.20	0.21	0%	-	0.20	0.28	0%	-	0.20	0.28	0%	-	0.18	0.19	0%	-	0.18	0.19	0%	-	0.17	0.17	0%	-
Lead	mg/L	0.001	0.01	0.000060	0.000062	0%	0%	0.000060	0.000084	0%	0%	0.000059	0.000084	0%	0%	0.000053	0.000056	0%	0%	0.000100	0.00015	0%	0%	0.000055	0.000057	0%	0%
Magnesium	mg/L	2.003	-	1.6	1.7	0%	-	1.6	2.4	13%	-	1.6	2.4	12%	-	1.4	1.5	0%	-	1.7	2.2	16%	-	1.4	1.4	0%	-
Manganese	mg/L	0.7	-	0.067	0.070	0%	-	0.067	0.094	0%	-	0.066	0.094	0%	-	0.060	0.063	0%	-	0.080	0.10	0%	-	0.059	0.061	0%	-
Molybdenum	mg/L	0.073	-	0.0013	0.0013	0%	-	0.0013	0.0021	0%	-	0.0013	0.002	0%	-	0.0011	0.0011	0%	-	0.0026	0.0042	0%	-	0.0011	0.0012	0%	-
Nickel	mg/L	0.025	-	0.0018	0.0018	0%	-	0.0018	0.0025	0%	-	0.0017	0.0025	0%	-	0.0016	0.0017	0%	-	0.0018	0.0020	0%	-	0.0015	0.0015	0%	-
Nitrate	mg/L	13	10	0.07	0.07	0%	0%	0.07	0.10	0%	0%	0.07	0.10	0%	0%	0.06	0.07	0%	0%	0.79	1.66	0%	0%	0.12	0.16	0%	0%
Phosphorus (Total)	mg/L	0.035	-	0.016	0.016	0%	-	0.016	0.022	0%	-	0.015	0.022	0%	-	0.014	0.015	0%	-	0.028	0.043	27%	-	0.014	0.015	0%	-
Potassium	mg/L	373	-	0.45	0.48	0%	-	0.47	0.80	0%	-	0.46	0.80	0%	-	0.4	0.4	0%	-	1.4	2.5	0%	-	0.44	0.49	0%	-
Sodium	mg/L	1.3365	-	1.4	1.5	59%	-	1.5	2.6	75%	-	1.4	2.6	64%	-	1.1	1	0%	-	1.3	1.7	56%	-	1.0	1.1	0%	-
Strontium	mg/L	0.026	-	0.020	0.021	0%	-	0.020	0.029	6%	-	0.020	0.028	5%	-	0.018	0.019	0%	-	0.045	0.072	100%	-	0.019	0.020	0%	-
Sulphate	mg/L	218	-	4.0	4.3	0%	-	4.2	7.3	0%	-	4.1	7.3	0%	-	3	4	0%	-	4.48	5.99	0%	-	3.2	3.2	0%	-
Uranium	mg/L	0.015	0.02	0.0012	0.0012	0%	0%	0.0012	0.0017	0%	0%	0.0012	0.0017	0%	0%	0.0010	0.0011	0%	0%	0.0031	0.0052	0%	0%	0.0012	0.0013	0%	0%
Vanadium	mg/L	0.006	-	0.0012	0.0012	0%	-	0.0012	0.0016	0%	-	0.0011	0.0016	0%	-	0.0010	0.0011	0%	-	0.0019	0.0029	0%	-	0.0011	0.0011	0%	-
Zinc	mg/L	0.032	-	0.010	0.011	0%	-	0.010	0.014	0%	-	0.010	0.014	0%	-	0.009	0.010	0%	-	0.013	0.016	0%	-	0.009	0.009	0%	-

Notes:

Med - Median Annual Concentration

Max - Maximum Annual Concentration

% > Aquatic Health Benchmark and % > Human Health Drinking Water Guideline - percentage of days during the climate year that the concentration is greater than the Aquatic Health Benchmark and Human Health Drinking Water Guideline, respectively.

0.001 - denotes concentrations that are greater than the Aquatic Health Benchmark.

0.001 - denotes concentrations that are greater than the Human Health Drinking Water Guideline.

(a) Aquatic Health Benchmark - The benchmark is equal to the most recent of the PWQO or CWQG (or the BCMOE guideline for parameters without a PWQO or CWQG) or the upper limit of background (95th percentile), whichever is higher (with the exception of cyanide, which has a site-specific guideline). If no guideline exists, then background was used as the benchmark.

(b) Human Health Drinking Water Guideline - The guideline is equal to the ODWS and CDWQG (where the same). For arsenic, the guideline is equal to the CDWQG. For nitrate, the benchmark is equal to the ODWS.

TABLE A7
WATER QUALITY MODELING RESULTS: COMPARISON OF EFFLUENT DISCHARGE RECEIVERS - AVERAGE YEAR CONDITION
CÔTÉ GOLD PROJECT

Parameter	Units	Aquatic Health Benchmark ^(a)	Human Health Benchmark ^(b)	Neville Lake (Lower Basin, Mixing Zone)				Mesomikenda Lake (Upper Middle Basin, Mixing Zone)			
				Med	Max	% > Aquatic Health Benchmark	% > Human Health Benchmark	Med	Max	% > Aquatic Health Benchmark	% > Human Health Benchmark
Aluminum	mg/L	0.1182	-	0.048	0.056	0%	-	0.052	0.056	0%	-
Ammonia (Total)	mg/L	6.89	-	0.07	0.44	0%	-	0.235	0.336	0%	-
Ammonia (Un-ionized)	mg/L	0.019	-	0.00025	0.0023	0%	-	0.00045	0.002	0%	-
Antimony	mg/L	0.02	0.006	0.000276203	0.00144	0%	0%	0.0010	0.0013	0%	0%
Arsenic	mg/L	0.005	0.01	0.0016	0.0048	0%	0%	0.0035	0.0045	0%	0%
Barium	mg/L	1.0	1	0.006	0.010	0%	0%	0.0083	0.010	0%	0%
Boron	mg/L	1.5	5	0.0053	0.0076	0%	0%	0.0065	0.0074	0%	0%
Cadmium	mg/L	0.000058	0.005	2.11115E-05	2.73E-05	0%	0%	0.000024	0.000027	0%	0%
Calcium	mg/L	10.465	-	8	29	39%	-	20	27	100%	-
Chloride	mg/L	120	-	0.8	1.6	0%	-	1.3	1.5	0%	-
Cobalt	mg/L	0.0025	-	0.00028	0.00041	0%	-	0.00035	0.00040	0%	-
Copper	mg/L	0.005	-	0.0012	0.0027	0%	-	0.0020	0.0025	0%	-
Cyanide (Total)	mg/L	-	-	0.0026	0.0035	0%	-	0.0014	0.0014	0%	-
Cyanide (Free)	mg/L	0.009784	0.2	0.000712239	0.000934	0%	0%	0.0003	0.0004	0%	0%
Iron	mg/L	0.369	-	0.18	0.18	0%	-	0.17	0.17	0%	-
Lead	mg/L	0.001	0.01	5.5E-05	1.2E-04	0%	0%	0.000088	0.00011	0%	0%
Magnesium	mg/L	2.003	-	1.4	1.8	0%	-	1.6	1.8	0%	-
Manganese	mg/L	0.7	-	0.061	0.085	0%	-	0.074	0.083	0%	-
Molybdenum	mg/L	0.073	-	0.0011	0.0033	0%	-	0.0023	0.0029	0%	-
Nickel	mg/L	0.025	-	0.0016	0.0018	0%	-	0.0017	0.0018	0%	-
Nitrate	mg/L	13	10	0.08	1.36	0%	0%	0.70	1.05	0%	0%
Phosphorus (Total)	mg/L	0.035	-	0.014	0.048	18%	-	0.025	0.033	0%	-
Potassium	mg/L	373	-	0.4	1.8	0%	-	1.2	1.6	0%	-
Sodium	mg/L	1.3365	-	1.1	2	22%	-	1.2	1.4	12%	-
Strontium	mg/L	0.026	-	0.018	0.052	34%	-	0.038	0.049	100%	-
Sulphate	mg/L	218	-	3	5	0%	-	4.07	4.71	0%	-
Uranium	mg/L	0.015	0.02	0.0011	0.0037	0%	0%	0.0026	0.0035	0%	0%
Vanadium	mg/L	0.006	-	0.0011	0.0022	0%	-	0.0017	0.0021	0%	-
Zinc	mg/L	0.032	-	0.009	0.013	0%	-	0.011	0.013	0%	-

Notes:

Med - Median Annual Concentration

Max - Maximum Annual Concentration

% > Aquatic Health Benchmark and % > Human Health Drinking Water Guideline - percentage of days during the climate year that the concentration is greater than the Aquatic Health Benchmark and Human Health Drinking Water Guideline, respectively.

0.001 - denotes concentrations that are greater than the Aquatic Health Benchmark.

0.001 - denotes concentrations that are greater than the Human Health Drinking Water Guideline.

(a) Aquatic Health Benchmark - The benchmark is equal to the most recent of the PWQO or CWQG (or the BCMOE guideline for parameters without a PWQO or CWQG) or the upper limit of background (95th percentile), whichever is higher (with the exception of cyanide, which has a site-specific guideline). If no guideline exists, then background was used as the benchmark.

(b) Human Health Drinking Water Guideline - The guideline is equal to the ODWS and CDWQG (where the same). For arsenic, the guideline is equal to the CDWQG. For nitrate, the benchmark is equal to the ODWS.

TABLE A8
WATER QUALITY MODELING RESULTS: COMPARISON OF EFFLUENT DISCHARGE RECEIVERS, 1:25-YEAR DRY CONDITION
CÔTÉ GOLD PROJECT

Parameter	Units	Aquatic Health Benchmark ^(a)	Human Health Benchmark ^(b)	Neville Lake (Lower Basin, Mixing Zone)				Mesomikenda Lake (Upper Middle Basin, Mixing Zone)			
				Med	Max	% > Aquatic Health Benchmark	% > Human Health Benchmark	Med	Max	% > Aquatic Health Benchmark	% > Human Health Benchmark
Aluminum	mg/L	0.1182	-	0.048	0.052	0%	-	0.055	0.060	0%	-
Ammonia (Total)	mg/L	6.89	-	0.07	0.08	0%	-	0.201	0.361	0%	-
Ammonia (Un-ionized)	mg/L	0.019	-	0.00010	0.0004	0%	-	0.00033	0.001	0%	-
Antimony	mg/L	0.02	0.006	0.00026	0.00028	0%	0%	0.0009	0.0016	0%	0%
Arsenic	mg/L	0.005	0.01	0.0016	0.0017	0%	0%	0.0034	0.0054	10%	0%
Barium	mg/L	1.0	1	0.006	0.006	0%	0%	0.0085	0.011	0%	0%
Boron	mg/L	1.5	5	0.0052	0.0056	0%	0%	0.0068	0.0082	0%	0%
Cadmium	mg/L	0.000058	0.005	2.1E-05	2.2E-05	0%	0%	0.000025	0.000029	0%	0%
Calcium	mg/L	10.465	-	8	8	0%	-	20	33	100%	-
Chloride	mg/L	120	-	0.8	0.8	0%	-	1.3	1.8	0%	-
Cobalt	mg/L	0.0025	-	0.00028	0.00030	0%	-	0.00037	0.00045	0%	-
Copper	mg/L	0.005	-	0.0011	0.0012	0%	-	0.0020	0.0029	0%	-
Cyanide (Total)	mg/L	-	-	0.0028	0.0037	0%	-	0.0014	0.0016	0%	-
Cyanide (Free)	mg/L	0.009784	0.2	0.00078	0.00098	0%	0%	0.0004	0.0004	0%	0%
Iron	mg/L	0.369	-	0.18	0.19	0%	-	0.18	0.19	0%	-
Lead	mg/L	0.001	0.01	5.4E-05	5.8E-05	0%	0%	0.000088	0.00012	0%	0%
Magnesium	mg/L	2.003	-	1.4	1.5	0%	-	1.7	1.9	0%	-
Manganese	mg/L	0.7	-	0.060	0.065	0%	-	0.077	0.092	0%	-
Molybdenum	mg/L	0.073	-	0.0011	0.0012	0%	-	0.0022	0.0033	0%	-
Nickel	mg/L	0.025	-	0.0016	0.0017	0%	-	0.0018	0.0019	0%	-
Nitrate	mg/L	13	10	0.06	0.07	0%	0%	0.58	1.13	0%	0%
Phosphorus (Total)	mg/L	0.035	-	0.014	0.015	0%	-	0.022	0.031	0%	-
Potassium	mg/L	373	-	0.4	0.4	0%	-	1.1	2.0	0%	-
Sodium	mg/L	1.3365	-	1.1	1	0%	-	1.3	1.5	28%	-
Strontium	mg/L	0.026	-	0.018	0.019	0%	-	0.037	0.058	100%	-
Sulphate	mg/L	218	-	3	4	0%	-	4.2	5.2	0%	-
Uranium	mg/L	0.015	0.02	0.0011	0.0011	0%	0%	0.0026	0.0042	0%	0%
Vanadium	mg/L	0.006	-	0.0010	0.0011	0%	-	0.0017	0.0024	0%	-
Zinc	mg/L	0.032	-	0.009	0.010	0%	-	0.012	0.014	0%	-

Notes:

Med - Median Annual Concentration

Max - Maximum Annual Concentration

% > Aquatic Health Benchmark and % > Human Health Drinking Water Guideline - percentage of days during the climate year that the concentration is greater than the Aquatic Health Benchmark and Human Health Drinking Water Guideline, respectively.

0.001 - denotes concentrations that are greater than the Aquatic Health Benchmark.

0.001 - denotes concentrations that are greater than the Human Health Drinking Water Guideline.

(a) Aquatic Health Benchmark - The benchmark is equal to the most recent of the PWQO or CWQG (or the BCMOE guideline for parameters without a PWQO or CWQG) or the upper limit of background (95th percentile), whichever is higher (with the exception of cyanide, which has a site-specific guideline). If no guideline exists, then background was used as the benchmark.

(b) Human Health Drinking Water Guideline - The guideline is equal to the ODWS and CDWQG (where the same). For arsenic, the guideline is equal to the CDWQG. For nitrate, the benchmark is equal to the ODWS.

TABLE A9
WATER QUALITY MODELING RESULTS: COMPARISON OF EFFLUENT DISCHARGE RECEIVERS - 1:25-YEAR WET CONDITION
CÔTÉ GOLD PROJECT

Parameter	Units	Aquatic Health Benchmark ^(a)	Human Health Benchmark ^(b)	Neville Lake (Lower Basin, Mixing Zone)				Mesomikenda Lake (Upper Middle Basin, Mixing Zone)			
				Med	Max	% > Aquatic Health Benchmark	% > Human Health Benchmark	Med	Max	% > Aquatic Health Benchmark	% > Human Health Benchmark
Aluminum	mg/L	0.1182	-	0.048	0.056	0%	-	0.055	0.065	0%	-
Ammonia (Total)	mg/L	6.89	-	0.07	0.48	0%	-	0.262	0.516	0%	-
Ammonia (Un-ionized)	mg/L	0.019	-	0.00023	0.0030	0%	-	0.0006	0.003	0%	-
Antimony	mg/L	0.02	0.006	0.00026	0.00176	0%	0%	0.0012	0.0021	0%	0%
Arsenic	mg/L	0.005	0.01	0.0016	0.0056	2%	0%	0.0041	0.0067	31%	0%
Barium	mg/L	1.0	1	0.006	0.011	0%	0%	0.0092	0.013	0%	0%
Boron	mg/L	1.5	5	0.0052	0.0081	0%	0%	0.0072	0.0094	0%	0%
Cadmium	mg/L	0.000058	0.005	2.1E-05	2.8E-05	0%	0%	0.000026	0.000032	0%	0%
Calcium	mg/L	10.465	-	8	35	39%	-	24	41	100%	-
Chloride	mg/L	120	-	0.8	1.8	0%	-	1.4	2.1	0%	-
Cobalt	mg/L	0.0025	-	0.00028	0.00044	0%	-	0.00039	0.00051	0%	-
Copper	mg/L	0.005	-	0.0011	0.0030	0%	-	0.0023	0.0035	0%	-
Cyanide (Total)	mg/L	-	-	0.0020	0.0037	0%	-	0.0014	0.0014	0%	-
Cyanide (Free)	mg/L	0.009784	0.2	0.00056	0.001	0%	0%	0.0004	0.0004	0%	0%
Iron	mg/L	0.369	-	0.17	0.18	0%	-	0.18	0.19	0%	-
Lead	mg/L	0.001	0.01	5.3E-05	1.3E-04	0%	0%	0.000100	0.00015	0%	0%
Magnesium	mg/L	2.003	-	1.4	1.9	0%	-	1.7	2.2	16%	-
Manganese	mg/L	0.7	-	0.060	0.090	0%	-	0.080	0.10	0%	-
Molybdenum	mg/L	0.073	-	0.0011	0.0036	0%	-	0.0026	0.0042	0%	-
Nickel	mg/L	0.025	-	0.0016	0.0018	0%	-	0.0018	0.0020	0%	-
Nitrate	mg/L	13	10	0.06	1.50	0%	0%	0.79	1.66	0%	0%
Phosphorus (Total)	mg/L	0.035	-	0.014	0.057	19%	-	0.028	0.043	27%	-
Potassium	mg/L	373	-	0.4	2.1	0%	-	1.4	2.5	0%	-
Sodium	mg/L	1.3365	-	1.1	2	14%	-	1.3	1.7	56%	-
Strontium	mg/L	0.026	-	0.018	0.061	38%	-	0.045	0.072	100%	-
Sulphate	mg/L	218	-	3	5	0%	-	4.48	5.99	0%	-
Uranium	mg/L	0.015	0.02	0.0010	0.0044	0%	0%	0.0031	0.0052	0%	0%
Vanadium	mg/L	0.006	-	0.0010	0.0025	0%	-	0.0019	0.0029	0%	-
Zinc	mg/L	0.032	-	0.009	0.014	0%	-	0.013	0.016	0%	-

Notes:

Med - Median Annual Concentration

Max - Maximum Annual Concentration

% > Aquatic Health Benchmark and % > Human Health Drinking Water Guideline - percentage of days during the climate year that the concentration is greater than the Aquatic Health Benchmark and Human Health Drinking Water Guideline, respectively.

0.001 - denotes concentrations that are greater than the Aquatic Health Benchmark.

0.001 - denotes concentrations that are greater than the Human Health Drinking Water Guideline.

(a) Aquatic Health Benchmark - The benchmark is equal to the most recent of the PWQO or CWQG (or the BCMOE guideline for parameters without a PWQO or CWQG) or the upper limit of background (95th percentile), whichever is higher (with the exception of cyanide, which has a site-specific guideline). If no guideline exists, then background was used as the benchmark.

(b) Human Health Drinking Water Guideline - The guideline is equal to the ODWS and CDWQG (where the same). For arsenic, the guideline is equal to the CDWQG. For nitrate, the benchmark is equal to the ODWS.

TABLE A10
WATER QUALITY MODELING RESULTS: OPERATIONS PHASE, AVERAGE YEAR CONDITION - PROJECT SITE COMPONENTS
CÔTÉ GOLD PROJECT

Parameter	Units	MMER	MINE SITE WATER MANAGEMENT COMPONENTS											
			Mine Rock Area Drainage		Ore Stockpile Drainage		Open Pit Sump		Mine Water Pond		Reclaim Pond		Polishing Pond	
			Avg	Max	Avg	Max	Med	Max	Med	Max	Med	Max	Med	Max
Aluminum	mg/L	-	0.056	1.1	0.10	1.7	0.14	0.17	0.10	0.25	0.060	0.075	0.089	0.19
Ammonia (Total)	mg/L	-	0.50	12	0.84	11	24	30	3.4	10	16	20	2.4	7.8
Ammonia (Un-ionized)	mg/L	-	0.0017	0.068	0.0029	0.067	0.046	0.197	0.009	0.047	0.026	0.10	0.0035	0.035
Antimony	mg/L	-	0.0049	0.098	0.009	0.15	0.014	0.018	0.0084	0.022	0.0010	0.0025	0.0074	0.016
Arsenic	mg/L	0.5	0.014	0.29	0.027	0.44	0.037	0.046	0.024	0.063	0.0012	0.0059	0.021	0.046
Barium	mg/L	-	0.017	0.35	0.032	0.54	0.069	0.085	0.036	0.082	0.042	0.049	0.030	0.064
Boron	mg/L	-	0.011	0.23	0.021	0.35	0.038	0.046	0.022	0.053	0.00037	0.0045	0.019	0.040
Cadmium	mg/L	-	0.000030	0.00059	0.000055	0.00091	0.00011	0.00014	0.000065	0.000142	0.000002	0.000014	0.000057	0.00011
Calcium	mg/L	-	93	1857	171	2855	265	327	159	409	48	68	137	302
Chloride	mg/L	-	3.9	79	7.2	121	11	14	6.9	17	20	25	5.9	13
Cobalt	mg/L	-	0.00066	0.013	0.0012	0.020	0.0019	0.0023	0.0012	0.0030	0.0009	0.0010	0.0011	0.0022
Copper	mg/L	0.3	0.0068	0.14	0.013	0.21	0.020	0.024	0.012	0.030	0.081	0.099	0.010	0.023
Cyanide (Total)	mg/L	1	-	-	-	-	0.0011	0.0014	0.00073	0.0012	0.80	1.3	0.00041	0.00071
Cyanide (Free)	mg/L	-	-	-	-	-	0.00011	0.00036	0.00014	0.00020	0.38	0.49	0.00009	0.00013
Iron	mg/L	-	0.029	0.59	0.054	0.91	0.15	0.17	0.13	0.19	0.41	0.49	0.12	0.18
Lead	mg/L	0.2	0.00023	0.0045	0.00042	0.0070	0.00093	0.0011	0.00047	0.0011	0.00010	0.00016	0.00042	0.00087
Magnesium	mg/L	-	1.9	38	3.5	59	9.4	11.4	4.7	9.7	20	25	3.8	7.9
Manganese	mg/L	-	0.12	2.4	0.22	3.70	0.40	0.48	0.24	0.56	0.048	0.082	0.20	0.42
Molybdenum	mg/L	-	0.0059	0.119	0.011	0.18	0.057	0.071	0.019	0.046	0.041	0.049	0.015	0.036
Nickel	mg/L	0.5	0.0013	0.027	0.0024	0.041	0.005	0.0062	0.0031	0.0066	0.0082	0.0099	0.0027	0.0053
Nitrate	mg/L	-	1.7	43	2.88	37	83	103	12	36	0.066	1.24	8.2	27
Phosphorus (Total)	mg/L	-	0.20	4.1	0.38	6.3	0.510	0.630	0.334	0.883	0.014	0.080	0.29	0.64
Potassium	mg/L	-	6.0	120	11	186	16	20	10	26	21	25	8.7	19
Sodium	mg/L	-	1.6	33	3.0	51	8.6	10	4.1	8.3	81	99	3.3	6.9
Strontium	mg/L	-	0.15	3.0	0.28	4.6	0.42	0.52	0.26	0.66	0.09	0.12	0.22	0.49
Sulphate	mg/L	-	7.1	142	13	219	34	41	16	35	203	247	13	28
Uranium	mg/L	-	0.011	0.23	0.021	0.35	0.034	0.042	0.020	0.051	0.0048	0.0076	0.017	0.038
Vanadium	mg/L	-	0.005	0.10	0.010	0.16	0.014	0.017	0.0089	0.023	0.0002	0.0020	0.0078	0.017
Zinc	mg/L	0.5	0.020	0.39	0.036	0.60	0.075	0.090	0.041	0.093	0.0022	0.0093	0.034	0.072

Notes:

Med - Median Annual Concentration

Max - Maximum Annual Concentration

Avg - Average Annual Concentration. Applied for the Mine Rock Drainage and Ore Stockpile Drainage, rather than the median, to account for days with zero discharge.

Dashes indicate that parameter was not modelled in the Mine Rock Area Drainage and Ore Stockpile Drainage.

0.001 - denotes concentrations that are greater than the MMER.

TABLE A11
WATER QUALITY MODELING RESULTS: OPERATIONS PHASE, 1:25-YEAR DRY CONDITION - PROJECT SITE COMPONENTS
CÔTÉ GOLD PROJECT

Parameter	Units	MMER	MINE SITE WATER MANAGEMENT COMPONENTS											
			Mine Rock Area Drainage		Ore Stockpile Drainage		Open Pit Sump		Mine Water Pond		Reclaim Pond		Polishing Pond	
			Avg	Max	Avg	Max	Med	Max	Med	Max	Med	Max	Med	Max
Aluminum	mg/L	-	0.080	3.6	0.08	1.6	0.14	0.17	0.09	0.38	0.059	0.081	0.112	0.22
Ammonia (Total)	mg/L	-	0.71	26	0.71	11	24.487	29.899	3.8	10	18	20	3.0	6.3
Ammonia (Un-ionized)	mg/L	-	0.0024	0.085	0.0024	0.060	0.049	0.199	0.009	0.035	0.025	0.12	0.0049	0.028
Antimony	mg/L	-	0.0070	0.313	0.007	0.14	0.014	0.018	0.0080	0.033	0.0010	0.0017	0.0093	0.019
Arsenic	mg/L	0.5	0.021	0.93	0.022	0.41	0.038	0.046	0.022	0.096	0.0011	0.0032	0.026	0.054
Barium	mg/L	-	0.025	1.12	0.026	0.49	0.070	0.085	0.035	0.120	0.045	0.050	0.039	0.071
Boron	mg/L	-	0.016	0.73	0.017	0.32	0.038	0.046	0.021	0.078	0.00023	0.0020	0.024	0.045
Cadmium	mg/L	-	0.000043	0.00191	0.000044	0.00084	0.00012	0.00014	0.000062	0.000206	0.000001	0.000006	0.000075	0.00013
Calcium	mg/L	-	134	5959	139	2625	269	327	150	622	46	57	170	350
Chloride	mg/L	-	5.7	252	5.9	111	11	14	6.5	26	22	25	7.4	15
Cobalt	mg/L	-	0.00096	0.043	0.0010	0.019	0.0019	0.0023	0.0011	0.0045	0.0009	0.0010	0.0013	0.0026
Copper	mg/L	0.3	0.0099	0.44	0.010	0.19	0.020	0.024	0.011	0.046	0.088	0.099	0.013	0.026
Cyanide (Total)	mg/L	1	-	-	-	-	0.0011	0.0014	0.00092	0.0012	0.89	1.3	0.00045	0.00100
Cyanide (Free)	mg/L	-	-	-	-	-	0.00011	0.00036	0.00016	0.00023	0.41	0.50	0.00010	0.00015
Iron	mg/L	-	0.042	1.89	0.044	0.83	0.15	0.17	0.14	0.24	0.44	0.50	0.15	0.19
Lead	mg/L	0.2	0.00033	0.0146	0.00034	0.0064	0.00094	0.0011	0.00045	0.0016	0.00009	0.00013	0.00057	0.00094
Magnesium	mg/L	-	2.8	123	2.9	54	9.6	11.4	4.6	13.6	22	25	5.3	8.4
Manganese	mg/L	-	0.17	7.7	0.18	3.40	0.40	0.48	0.23	0.82	0.047	0.063	0.26	0.48
Molybdenum	mg/L	-	0.0085	0.381	0.009	0.17	0.058	0.071	0.022	0.045	0.044	0.050	0.021	0.030
Nickel	mg/L	0.5	0.0019	0.085	0.0020	0.037	0.005	0.0062	0.0031	0.0094	0.0089	0.0099	0.0035	0.0058
Nitrate	mg/L	-	2.5	88	2.45	36	84	103	13	35	0.002	0.48	10.2	22
Phosphorus (Total)	mg/L	-	0.29	13.1	0.31	5.8	0.518	0.630	0.294	1.359	0.012	0.041	0.36	0.76
Potassium	mg/L	-	8.7	387	9	171	16	20	9	40	22	25	10.8	22
Sodium	mg/L	-	2.4	106	2.5	47	8.7	10	4.1	11.7	88	99	4.6	7.2
Strontium	mg/L	-	0.22	9.7	0.22	4.3	0.43	0.52	0.24	1.01	0.09	0.11	0.28	0.57
Sulphate	mg/L	-	10.2	456	11	201	34	41	16	50	221	248	18	30
Uranium	mg/L	-	0.017	0.74	0.017	0.32	0.034	0.042	0.019	0.077	0.0047	0.0061	0.021	0.043
Vanadium	mg/L	-	0.007	0.33	0.008	0.15	0.014	0.017	0.0082	0.035	0.0002	0.0009	0.0096	0.020
Zinc	mg/L	0.5	0.028	1.26	0.029	0.56	0.076	0.090	0.039	0.135	0.0020	0.0052	0.044	0.080

Notes:

Med - Median Annual Concentration

Max - Maximum Annual Concentration

Avg - Average Annual Concentration. Applied for the Mine Rock Drainage and Ore Stockpile Drainage, rather than the median, to account for days with zero discharge.

Dashes indicate that parameter was not modelled in the Mine Rock Area Drainage and Ore Stockpile Drainage.

0.001

- denotes concentrations that are greater than the MMER.

TABLE A12
WATER QUALITY MODELING RESULTS: OPERATIONS PHASE, 1:25-YEAR WET CONDITION - PROJECT SITE COMPONENTS
CÔTÉ GOLD PROJECT

Parameter	Units	MMER	MINE SITE WATER MANAGEMENT COMPONENTS											
			Mine Rock Area Drainage		Ore Stockpile Drainage		Open Pit Sump		Mine Water Pond		Reclaim Pond		Polishing Pond	
			Avg	Max	Avg	Max	Med	Max	Med	Max	Med	Max	Med	Max
Aluminum	mg/L	-	0.075	3.0	0.09	1.5	0.11	0.17	0.10	0.18	0.056	0.073	0.094	0.12
Ammonia (Total)	mg/L	-	0.73	19	0.87	10	19	30	2.8	11	16	20	2.2	6.4
Ammonia (Un-ionized)	mg/L	-	0.1091	0.002	0.0027	0.063	0.042	0.192	0.007	0.032	0.027	0.10	0.0038	0.029
Antimony	mg/L	-	0.0066	0.266	0.008	0.13	0.011	0.018	0.0079	0.015	0.0010	0.0017	0.0078	0.010
Arsenic	mg/L	0.5	0.019	0.79	0.023	0.37	0.029	0.046	0.022	0.045	0.0011	0.0037	0.022	0.028
Barium	mg/L	-	0.023	0.95	0.028	0.45	0.055	0.085	0.036	0.058	0.040	0.050	0.031	0.043
Boron	mg/L	-	0.015	0.62	0.018	0.30	0.031	0.046	0.022	0.038	0.00025	0.0028	0.020	0.026
Cadmium	mg/L	-	0.000040	0.00162	0.000047	0.00077	0.00009	0.00014	0.000064	0.000103	0.000001	0.000009	0.000059	0.00008
Calcium	mg/L	-	125	5069	147	2413	209	327	149	291	43	52	143	185
Chloride	mg/L	-	5.3	215	6.2	102	9	14	6.5	12	20	25	6.2	8
Cobalt	mg/L	-	0.00089	0.036	0.0011	0.017	0.0015	0.0023	0.0012	0.0022	0.0008	0.0010	0.0011	0.0014
Copper	mg/L	0.3	0.0092	0.37	0.011	0.18	0.016	0.024	0.011	0.022	0.080	0.099	0.011	0.014
Cyanide (Total)	mg/L	1	-	-	-	-	0.0012	0.0014	0.00085	0.0012	0.80	1.3	0.00040	0.00088
Cyanide (Free)	mg/L	-	-	-	-	-	0.00017	0.00036	0.00015	0.00021	0.38	0.50	0.00009	0.00017
Iron	mg/L	-	0.040	1.61	0.047	0.77	0.16	0.17	0.14	0.17	0.40	0.50	0.12	0.15
Lead	mg/L	0.2	0.00031	0.0124	0.00036	0.0059	0.00074	0.0011	0.00046	0.0008	0.00009	0.00012	0.00044	0.00059
Magnesium	mg/L	-	2.6	105	3.0	50	7.7	11.4	4.6	7.7	20	25	3.9	5.7
Manganese	mg/L	-	0.16	6.6	0.19	3.13	0.32	0.48	0.23	0.40	0.045	0.061	0.21	0.27
Molybdenum	mg/L	-	0.0080	0.324	0.009	0.15	0.045	0.071	0.019	0.046	0.040	0.050	0.014	0.029
Nickel	mg/L	0.5	0.0018	0.072	0.0021	0.034	0.004	0.0062	0.0032	0.0049	0.0080	0.0099	0.0028	0.0037
Nitrate	mg/L	-	2.5	64	3.00	35	65	103	10	36	0.016	0.76	7.4	22
Phosphorus (Total)	mg/L	-	0.28	11.2	0.32	5.3	0.402	0.630	0.308	0.633	0.011	0.050	0.31	0.40
Potassium	mg/L	-	8.1	329	10	157	13	20	9	19	20	25	9.1	12
Sodium	mg/L	-	2.2	90	2.6	43	6.9	10	4.0	7.0	80	99	3.4	5.0
Strontium	mg/L	-	0.20	8.2	0.24	3.9	0.33	0.52	0.24	0.47	0.09	0.10	0.23	0.30
Sulphate	mg/L	-	9.6	388	11	185	27	41	16	27	199	248	14	20
Uranium	mg/L	-	0.015	0.63	0.018	0.30	0.027	0.042	0.019	0.036	0.0044	0.0057	0.018	0.023
Vanadium	mg/L	-	0.007	0.28	0.008	0.14	0.011	0.017	0.0084	0.016	0.0002	0.0012	0.0082	0.011
Zinc	mg/L	0.5	0.026	1.07	0.031	0.51	0.060	0.090	0.040	0.066	0.0021	0.0061	0.035	0.048

Notes:

Med - Median Annual Concentration

Max - Maximum Annual Concentration

Avg - Average Annual Concentration. Applied for the Mine Rock Drainage and Ore Stockpile Drainage, rather than the median, to account for days with zero discharge.

Dashes indicate that parameter was not modelled in the Mine Rock Area Drainage and Ore Stockpile Drainage.

0.001 - denotes concentrations that are greater than the MMER.



APPENDIX B

Water Quality Model Results: Post-closure Phase Stage I

TABLE B1
WATER QUALITY MODELING RESULTS: POST-CLOSURE PHASE STAGE I, AVERAGE CONDITION - MOLLIE RIVER WATERSHED
CÔTÉ GOLD PROJECT

Parameter	Units	Aquatic Health Benchmark ^(a)	Human Health Benchmark ^(b)	MOLLIE RIVER WATERSHED																			
				Chester Lake				Clam Lake				Little Clam Lake				Bagsverd Lake (South)				Weeduck Lake			
				Med	Max	% > Aquatic Health Benchmark	% > Human Health Benchmark	Med	Max	% > Aquatic Health Benchmark	% > Human Health Benchmark	Med	Max	% > Aquatic Health Benchmark	% > Human Health Benchmark	Med	Max	% > Aquatic Health Benchmark	% > Human Health Benchmark	Med	Max	% > Aquatic Health Benchmark	% > Human Health Benchmark
Aluminum	mg/L	0.1182	-	0.047	0.051	0%	-	0.049	0.051	0%	-	0.050	0.070	0%	-	0.050	0.057	0%	-	0.050	0.054	0%	-
Ammonia (Total)	mg/L	6.89	-	0.050	0.053	0%	-	0.052	0.053	0%	-	0.053	0.073	0%	-	0.053	0.060	0%	-	0.053	0.057	0%	-
Ammonia (Un-ionized)	mg/L	0.019	-	0.00008	0.0003	0%	-	0.000089	0.00034	0%	-	0.000091	0.00037	0%	-	0.00010	0.00038	0%	-	0.000094	0.00036	0%	-
Antimony	mg/L	0.02	0.006	0.0004	0.0004	0%	0%	0.00034	0.00041	0%	0%	0.00035	0.00048	0%	0%	0.00035	0.00039	0%	0%	0.00035	0.00038	0%	0%
Arsenic	mg/L	0.005	0.01	0.0019	0.0021	0%	0%	0.0018	0.0020	0%	0%	0.0019	0.0025	0%	0%	0.0018	0.0021	0%	0%	0.0019	0.0020	0%	0%
Barium	mg/L	1.0	1	0.0061	0.0067	0%	0%	0.0063	0.0067	0%	0%	0.0065	0.0089	0%	0%	0.0064	0.0073	0%	0%	0.0065	0.0070	0%	0%
Boron	mg/L	1.5	5	0.0052	0.0057	0%	0%	0.0055	0.0057	0%	0%	0.0056	0.0077	0%	0%	0.0055	0.0063	0%	0%	0.0056	0.0060	0%	0%
Cadmium	mg/L	0.000058	0.005	0.000021	0.000022	0%	0%	0.000022	0.000022	0%	0%	0.000022	0.000030	0%	0%	0.000022	0.000025	0%	0%	0.000022	0.000024	0%	0%
Calcium	mg/L	10.465	-	9.9	11	13%	-	9.2	10	13%	-	9.5	13	14%	-	9.4	11	8%	-	9.4	10	0%	-
Chloride	mg/L	120	-	0.81	0.89	0%	-	0.81	0.87	0%	-	0.84	1.1	0%	-	0.82	0.94	0%	-	0.83	0.90	0%	-
Cobalt	mg/L	0.0025	-	0.00028	0.00031	0%	-	0.00029	0.00030	0%	-	0.00030	0.00041	0%	-	0.00029	0.00034	0%	-	0.00030	0.00032	0%	-
Copper	mg/L	0.005	-	0.0012	0.0013	0%	-	0.0012	0.0013	0%	-	0.0012	0.0017	0%	-	0.0012	0.0014	0%	-	0.0012	0.0013	0%	-
Cyanide (Total)	mg/L	-	-	-	-	-	-	-	-	-	-	-	-	-	-	-	-	-	-	-	-	-	-
Cyanide (Free)	mg/L	0.009784	0.2	-	-	-	-	-	-	-	-	-	-	-	-	-	-	-	-	-	-	-	-
Iron	mg/L	0.369	-	0.17	0.18	0%	-	0.18	0.18	0%	-	0.18	0.25	0%	-	0.18	0.21	0%	-	0.18	0.20	0%	-
Lead	mg/L	0.001	0.01	0.00006	0.00006	0%	0%	0.000057	0.000062	0%	0%	0.000060	0.000081	0%	0%	0.000058	0.000067	0%	0%	0.000059	0.000064	0%	0%
Magnesium	mg/L	2.003	-	1.4	1.5	0%	-	1.4	1.5	0%	-	1.5	2.0	0%	-	1.5	1.7	0%	-	1.5	1.6	0%	-
Manganese	mg/L	0.7	-	0.060	0.066	0%	-	0.063	0.066	0%	-	0.065	0.089	0%	-	0.06	0.07	0%	-	0.064	0.069	0%	-
Molybdenum	mg/L	0.073	-	0.0012	0.0013	0%	-	0.0011	0.0012	0%	-	0.0012	0.0016	0%	-	0.0012	0.0013	0%	-	0.0012	0.0013	0%	-
Nickel	mg/L	0.025	-	0.0015	0.0017	0%	-	0.0016	0.0017	0%	-	0.0016	0.0023	0%	-	0.0016	0.0019	0%	-	0.0016	0.0018	0%	-
Nitrate	mg/L	13	10	0.062	0.066	0%	0%	0.064	0.066	0%	0%	0.066	0.091	0%	0%	0.065	0.075	0%	0%	0.066	0.071	0%	0%
Phosphorus (Total)	mg/L	0.035	-	0.019	0.022	0%	-	0.017	0.020	0%	-	0.018	0.024	0%	-	0.018	0.020	0%	-	0.018	0.019	0%	-
Potassium	mg/L	373	-	0.52	0.58	0%	-	0.46	0.54	0%	-	0.47	0.64	0%	-	0.47	0.53	0%	-	0.47	0.51	0%	-
Sodium	mg/L	1.3365	-	1.0	1.1	0%	-	1.1	1.1	0%	-	1.1	1.5	2%	-	1.1	1.2	0%	-	1.1	1.2	0%	-
Strontium	mg/L	0.026	-	0.021	0.023	0%	-	0.020	0.023	0%	-	0.021	0.029	1%	-	0.021	0.023	0%	-	0.021	0.022	0%	-
Sulphate	mg/L	218	-	3.1	3.4	0%	-	3.3	3.4	0%	-	3.4	4.6	0%	-	3.3	3.8	0%	-	3.4	3.6	0%	-
Uranium	mg/L	0.015	0.02	0.0013	0.0015	0%	0%	0.0012	0.0014	0%	0%	0.0013	0.0017	0%	0%	0.0013	0.0014	0%	0%	0.0013	0.0014	0%	0%
Vanadium	mg/L	0.006	-	0.0011	0.0012	0%	-	0.0011	0.0012	0%	-	0.0012	0.0016	0%	-	0.0012	0.0013	0%	-	0.0012	0.0013	0%	-
Zinc	mg/L	0.032	-	0.0091	0.010	0%	-	0.0095	0.010	0%	-	0.0098	0.013	0%	-	0.0096	0.011	0%	-	0.0097	0.011	0%	-

Notes:

Med - Median Annual Concentration

Max - Maximum Annual Concentration

% > Aquatic Health Benchmark and % > Human Health Drinking Water Guideline - percentage of days during the climate year that the concentration is greater than the Aquatic Health Benchmark and Human Health Drinking Water Guideline, respectively.

0.001 - denotes concentrations that are greater than the Aquatic Health Benchmark.

0.001 - denotes concentrations that are greater than the Human Health Drinking Water Guideline.

(a) Aquatic Health Benchmark - The benchmark is equal to the most recent of the PWQO or CWQG (or the BCMOE guideline for parameters without a PWQO or CWQG) or the upper limit of background (95th percentile), whichever is higher (with the exception of cyanide, which has a site-specific guideline). If no guideline exists, then background was used as the benchmark.

(b) Human Health Drinking Water Guideline - The guideline is equal to the ODWS and CDWQG (where the same). For arsenic, the guideline is equal to the CDWQG. For nitrate, the benchmark is equal to the ODWS.

TABLE B1
WATER QUALITY MODELING RESULTS: POST-CLOSURE PHASE STAGE I, AVERAGE CONDITION - MOLLIE RIVER WATERSHED
CÔTÉ GOLD PROJECT

Parameter	Units	Aquatic Health Benchmark ^(a)	Human Health Benchmark ^(b)	MOLLIE RIVER WATERSHED															
				Three Duck Lakes (Upper/Middle)				Three Duck Lakes (Lower)				Delaney Lake				Dividing Lake			
				Med	Max	% > Aquatic Health Benchmark	% > Human Health Benchmark	Med	Max	% > Aquatic Health Benchmark	% > Human Health Benchmark	Med	Max	% > Aquatic Health Benchmark	% > Human Health Benchmark	Med	Max	% > Aquatic Health Benchmark	% > Human Health Benchmark
Aluminum	mg/L	0.1182	-	0.050	0.061	0%	-	0.051	0.052	0%	-	0.064	0.082	0%	-	0.052	0.052	0%	-
Ammonia (Total)	mg/L	6.89	-	0.052	0.063	0%	-	0.053	0.054	0%	-	0.067	0.086	0%	-	0.054	0.054	0%	-
Ammonia (Un-ionized)	mg/L	0.019	-	0.00010	0.00041	0%	-	0.00088	0.00035	0%	-	0.00013	0.00048	0%	-	0.00092	0.00036	0%	-
Antimony	mg/L	0.02	0.006	0.00039	0.00060	0%	0%	0.00041	0.00045	0%	0%	0.00045	0.00064	0%	0%	0.00039	0.00039	0%	0%
Arsenic	mg/L	0.005	0.01	0.0020	0.0026	0%	0%	0.0020	0.0022	0%	0%	0.0024	0.0032	0%	0%	0.0020	0.0020	0%	0%
Barium	mg/L	1.0	1	0.0066	0.0082	0%	0%	0.0066	0.0069	0%	0%	0.0083	0.011	0%	0%	0.0067	0.0067	0%	0%
Boron	mg/L	1.5	5	0.0056	0.0069	0%	0%	0.0057	0.0059	0%	0%	0.0071	0.009	0%	0%	0.0057	0.0058	0%	0%
Cadmium	mg/L	0.000058	0.005	0.000022	0.000027	0%	0%	0.000022	0.000023	0%	0%	0.000028	0.000036	0%	0%	0.000023	0.000023	0%	0%
Calcium	mg/L	10.465	-	10	14	48%	-	11	11	54%	-	12	16	74%	-	10	10	0%	-
Chloride	mg/L	120	-	0.86	1.1	0%	-	0.87	0.92	0%	-	1.1	1.4	0%	-	0.87	0.87	0%	-
Cobalt	mg/L	0.0025	-	0.00030	0.00037	0%	-	0.000303	0.000315	0%	-	0.00038	0.00049	0%	-	0.000307	0.00031	0%	-
Copper	mg/L	0.005	-	0.0013	0.0016	0%	-	0.0013	0.0014	0%	-	0.0016	0.0021	0%	-	0.0013	0.0013	0%	-
Cyanide (Total)	mg/L	-	-	-	-	-	-	-	-	-	-	-	-	-	-	-	-	-	-
Cyanide (Free)	mg/L	0.009784	0.2	-	-	-	-	-	-	-	-	-	-	-	-	-	-	-	-
Iron	mg/L	0.369	-	0.18	0.22	0%	-	0.18	0.19	0%	-	0.23	0.30	0%	-	0.19	0.19	0%	-
Lead	mg/L	0.001	0.01	0.000061	0.000076	0%	0%	0.000061	0.000064	0%	0%	0.000076	0.0001	0%	0%	0.000061	0.000062	0%	0%
Magnesium	mg/L	2.003	-	1.5	1.8	0%	-	1.5	1.5	0%	-	1.9	2.4	32%	-	1.5	1.5	0%	-
Manganese	mg/L	0.7	-	0.065	0.079	0%	-	0.065	0.068	0%	-	0.082	0.11	0%	-	0.066	0.067	0%	-
Molybdenum	mg/L	0.073	-	0.0012	0.0016	0%	-	0.0012	0.0013	0%	-	0.0015	0.0020	0%	-	0.0012	0.0012	0%	-
Nickel	mg/L	0.025	-	0.0016	0.0020	0%	-	0.0016	0.0017	0%	-	0.0021	0.0027	0%	-	0.0017	0.0017	0%	-
Nitrate	mg/L	13	10	0.065	0.078	0%	0%	0.065	0.067	0%	0%	0.084	0.11	0%	0%	0.067	0.067	0%	0%
Phosphorus (Total)	mg/L	0.035	-	0.020	0.028	0%	-	0.020	0.022	0%	-	0.023	0.032	0%	-	0.019	0.020	0%	-
Potassium	mg/L	373	-	0.52	0.78	0%	-	0.55	0.59	0%	-	0.61	0.8	0%	-	0.52	0.52	0%	-
Sodium	mg/L	1.3365	-	1.1	1.3	3%	-	1.1	1.1	0%	-	1.4	1.8	61%	-	1.1	1.1	0%	-
Strontium	mg/L	0.026	-	0.022	0.029	27%	-	0.023	0.024	0%	-	0.027	0.036	56%	-	0.022	0.022	0%	-
Sulphate	mg/L	218	-	3.4	4.2	0%	-	3.4	3.5	0%	-	4.3	5.5	0%	-	3.5	3.5	0%	-
Uranium	mg/L	0.015	0.02	0.0014	0.0019	0%	0%	0.0014	0.0015	0%	0%	0.0016	0.0022	0%	0%	0.0014	0.0014	0%	0%
Vanadium	mg/L	0.006	-	0.0012	0.0015	0%	-	0.0012	0.0013	0%	-	0.0015	0.0020	0%	-	0.0012	0.0012	0%	-
Zinc	mg/L	0.032	-	0.0098	0.012	0%	-	0.0099	0.010	0%	-	0.012	0.016	0%	-	0.010	0.010	0%	-

Notes:

Med - Median Annual Concentration

Max - Maximum Annual Concentration

% > Aquatic Health Benchmark and % > Human Health Drinking Water Guideline - percentage of days during the climate year that the concentration is greater than the Aquatic Health Benchmark and Human Health Drinking Water Guideline, respectively.

0.001 - denotes concentrations that are greater than the Aquatic Health Benchmark.

0.001 - denotes concentrations that are greater than the Human Health Benchmark.

(a) Aquatic Health Benchmark - The benchmark is equal to the most recent of the PWQO or CWQG (or the BCMOE guideline for parameters without a PWQO or CWQG) or the upper limit of background (95th percentile), whichever is higher (with the exception of cyanide, which has a site-specific guideline). If no guideline exists, then background was used as the benchmark.

(b) Human Health Drinking Water Guideline - The guideline is equal to the ODWS and CDWQG (where the same). For arsenic, the guideline is equal to the CDWQG. For nitrate, the benchmark is equal to the ODWS.

TABLE B2
WATER QUALITY MODELING RESULTS: POST-CLOSURE PHASE STAGE I, 1:25-YEAR DRY CONDITION - MOLLIE RIVER WATERSHED
CÔTÉ GOLD PROJECT

Parameter	Units	Aquatic Health Benchmark ^(a)	Human Health Benchmark ^(b)	MOLLIE RIVER WATERSHED																			
				Chester Lake				Clam Lake				Little Clam Lake				Bagsverd Lake (South)				Weeduck Lake			
				Med	Max	% > Aquatic Health Benchmark	% > Human Health Benchmark	Med	Max	% > Aquatic Health Benchmark	% > Human Health Benchmark	Med	Max	% > Aquatic Health Benchmark	% > Human Health Benchmark	Med	Max	% > Aquatic Health Benchmark	% > Human Health Benchmark	Med	Max	% > Aquatic Health Benchmark	% > Human Health Benchmark
Aluminum	mg/L	0.1182	-	0.049	0.056	0%	-	0.050	0.054	0%	-	0.052	0.064	0%	-	0.050	0.061	0%	-	0.051	0.056	0%	-
Ammonia (Total)	mg/L	6.89	-	0.050	0.058	0%	-	0.052	0.055	0%	-	0.054	0.067	0%	-	0.053	0.064	0%	-	0.054	0.059	0%	-
Ammonia (Un-ionized)	mg/L	0.019	-	0.00008	0.0003	0%	-	0.00009	0.00035	0%	-	0.000094	0.00041	0%	-	0.00011	0.00040	0%	-	0.00010	0.00036	0%	-
Antimony	mg/L	0.02	0.006	0.0005	0.0005	0%	0%	0.00040	0.00046	0%	0%	0.00042	0.00047	0%	0%	0.00037	0.00044	0%	0%	0.00037	0.00040	0%	0%
Arsenic	mg/L	0.005	0.01	0.0022	0.0024	0%	0%	0.00195	0.00220	0%	0%	0.0021	0.0024	0%	0%	0.0019	0.0023	0%	0%	0.0019	0.0021	0%	0%
Barium	mg/L	1.0	1	0.0066	0.0074	0%	0%	0.0065	0.00702	0%	0%	0.0068	0.0082	0%	0%	0.0065	0.0078	0%	0%	0.0066	0.0072	0%	0%
Boron	mg/L	1.5	5	0.0056	0.0063	0%	0%	0.0056	0.0060	0%	0%	0.0058	0.0071	0%	0%	0.0056	0.0067	0%	0%	0.0057	0.0062	0%	0%
Cadmium	mg/L	0.000058	0.005	0.000022	0.000025	0%	0%	0.00002	0.00002	0%	0%	0.00002	0.00003	0%	0%	0.000022	0.000027	0%	0%	0.00002	0.00002	0%	0%
Calcium	mg/L	10.465	-	12	13	82%	-	10	12	35%	-	11	12	56%	-	9.7	12	33%	-	9.8	11	14%	-
Chloride	mg/L	120	-	0.90	1.0	0%	-	0.85	0.94	0%	-	0.89	1.1	0%	-	0.83	1.0	0%	-	0.85	0.93	0%	-
Cobalt	mg/L	0.0025	-	0.00030	0.00034	0%	-	0.00030	0.00032	0%	-	0.00031	0.00038	0%	-	0.00030	0.00036	0%	-	0.00030	0.00033	0%	-
Copper	mg/L	0.005	-	0.0014	0.0015	0%	-	0.0013	0.0014	0%	-	0.0013	0.0016	0%	-	0.0012	0.0015	0%	-	0.0013	0.0014	0%	-
Cyanide (Total)	mg/L	-	-	-	-	-	-	-	-	-	-	-	-	-	-	-	-	-	-	-	-	-	-
Cyanide (Free)	mg/L	0.009784	0.2	-	-	-	-	-	-	-	-	-	-	-	-	-	-	-	-	-	-	-	-
Iron	mg/L	0.369	-	0.17	0.20	0%	-	0.18	0.19	0%	-	0.19	0.23	0%	-	0.18	0.22	0%	-	0.19	0.20	0%	-
Lead	mg/L	0.001	0.01	0.00006	0.00007	0%	0%	0.000060	0.000066	0%	0%	0.000063	0.000075	0%	0%	0.000059	0.000072	0%	0%	0.000060	0.000066	0%	0%
Magnesium	mg/L	2.003	-	1.4	1.6	0%	-	1.5	1.6	0%	-	1.5	1.9	0%	-	1.5	1.8	0%	-	1.5	1.6	0%	-
Manganese	mg/L	0.7	-	0.064	0.073	0%	-	0.064	0.069	0.00000	-	0.067	0.081	0%	-	0.064	0.078	0%	-	0.065	0.071	0%	-
Molybdenum	mg/L	0.073	-	0.0013	0.0014	0%	-	0.0012	0.0013	0%	-	0.0013	0.0015	0%	-	0.0012	0.0014	0%	-	0.0012	0.0013	0%	-
Nickel	mg/L	0.025	-	0.0016	0.0018	0%	-	0.0016	0.0017	0%	-	0.0017	0.0021	0%	-	0.0016	0.0020	0%	-	0.0017	0.0018	0%	-
Nitrate	mg/L	13	10	0.062	0.072	0%	0%	0.065	0.069	0%	0%	0.067	0.083	0%	0%	0.065	0.079	0%	0%	0.067	0.073	0%	0%
Phosphorus (Total)	mg/L	0.035	-	0.023	0.025	0%	-	0.020	0.022	0%	-	0.021	0.024	0%	-	0.019	0.022	0%	-	0.019	0.020	0%	-
Potassium	mg/L	373	-	0.63	0.69	0%	-	0.53	0.60	0%	-	0.55	0.63	0%	-	0.50	0.59	0%	-	0.50	0.54	0%	-
Sodium	mg/L	1.3365	-	1.1	1.2	0%	-	1.1	1.2	0%	-	1.1	1.4	0%	-	1.1	1.3	0%	-	1.1	1.2	0%	-
Strontium	mg/L	0.026	-	0.024	0.026	4%	-	0.022	0.024	0%	-	0.023	0.027	0%	-	0.021	0.026	0%	-	0.022	0.023	0%	-
Sulphate	mg/L	218	-	3.4	3.8	0%	-	3.4	3.6	0%	-	3.5	4.3	0%	-	3.4	4.1	0%	-	3.4	3.7	0%	-
Uranium	mg/L	0.015	0.02	0.0016	0.0017	0%	0%	0.0014	0.0015	0%	0%	0.0014	0.0017	0%	0%	0.0013	0.0016	0%	0%	0.0013	0.0014	0%	0%
Vanadium	mg/L	0.006	-	0.0013	0.0014	0%	-	0.0012	0.0013	0%	-	0.0012	0.0015	0%	-	0.0012	0.0014	0%	-	0.0012	0.0013	0%	-
Zinc	mg/L	0.032	-	0.010	0.011	0%	-	0.0098	0.010	0%	-	0.010	0.012	0%	-	0.0097	0.012	0%	-	0.010	0.011	0%	-

Notes:
 Med - Median Annual Concentration
 Max - Maximum Annual Concentration
 % > Aquatic Health Benchmark and % > Human Health Drinking Water Guideline - percentage of days during the climate year that the concentration is greater than the Aquatic Health Benchmark and Human Health Drinking Water Guideline, respectively.
0.001 - denotes concentrations that are greater than the Aquatic Health Benchmark.
0.001 - denotes concentrations that are greater than the Human Health Drinking Water Guideline.

(a) Aquatic Health Benchmark - The benchmark is equal to the most recent of the PWQO or CWQG (or the BCMOE guideline for parameters without a PWQO or CWQG) or the upper limit of background (95th percentile), whichever is higher (with the exception of cyanide, which has a site-specific guideline). If no guideline exists, then background was used as the benchmark.

(b) Human Health Drinking Water Guideline - The guideline is equal to the ODWS and CDWQG (where the same). For arsenic, the guideline is equal to the CDWQG. For nitrate, the benchmark is equal to the ODWS.

TABLE B2
WATER QUALITY MODELING RESULTS: POST-CLOSURE PHASE STAGE I, 1:25-YEAR DRY CONDITION - MOLLIE RIVER WATERSHED
CÔTÉ GOLD PROJECT

Parameter	Units	Aquatic Health Benchmark ^(a)	Human Health Benchmark ^(b)	MOLLIE RIVER WATERSHED															
				Three Duck Lakes (Upper/Middle)				Three Duck Lakes (Lower)				Delaney Lake				Dividing Lake			
				Med	Max	% > Aquatic Health Benchmark	% > Human Health Benchmark	Med	Max	% > Aquatic Health Benchmark	% > Human Health Benchmark	Med	Max	% > Aquatic Health Benchmark	% > Human Health Benchmark	Med	Max	% > Aquatic Health Benchmark	% > Human Health Benchmark
Aluminum	mg/L	0.1182	-	0.053	0.068	0%	-	0.050	0.053	0%	-	0.069	0.11	0%	-	0.052	0.053	0%	-
Ammonia (Total)	mg/L	6.89	-	0.053	0.067	0%	-	0.052	0.054	0%	-	0.071761	0.11	0%	-	0.054	0.055	0%	-
Ammonia (Un-ionized)	mg/L	0.019	-	0.00011	0.00042	0%	-	0.000087	0.00034	0%	-	0.00017	0.00061	0%	-	0.000093	0.00036	0%	-
Antimony	mg/L	0.02	0.006	0.00054	0.00078	0%	0%	0.00045	0.00050	0%	0%	0.00057	0.0010	0%	0%	0.00041	0.00042	0%	0%
Arsenic	mg/L	0.005	0.01	0.0024	0.0033	0%	0%	0.0021	0.0023	0%	0%	0.0028	0.0045	0%	0%	0.0021	0.0021	0%	0%
Barium	mg/L	1.0	1	0.0073	0.0094	0%	0%	0.0067	0.0071	0%	0%	0.009	0.014	0%	0%	0.0068	0.0069	0%	0%
Boron	mg/L	1.5	5	0.0061	0.0078	0%	0%	0.0057	0.0060	0%	0%	0.0078	0.012	0%	0%	0.0058	0.0059	0%	0%
Cadmium	mg/L	0.000058	0.005	0.000023	0.000030	0%	0%	0.000022	0.000023	0%	0%	0.000030	0.00005	0%	0%	0.000023	0.000023	0%	0%
Calcium	mg/L	10.465	-	13	18	58%	-	11	12	100%	-	15	24	89%	-	11	11	100%	-
Chloride	mg/L	120	-	1.0	1.3	0%	-	0.89	0.96	0%	-	1.2	1.9	0%	-	0.89	0.90	0%	-
Cobalt	mg/L	0.0025	-	0.00033	0.00042	0%	-	0.00030	0.00032	0%	-	0.00041	0.000646	0%	-	0.00031	0.00032	0%	-
Copper	mg/L	0.005	-	0.0015	0.0020	0%	-	0.0013	0.0014	0%	-	0.0018	0.0029	0%	-	0.0013	0.0013	0%	-
Cyanide (Total)	mg/L	-	-	-	-	-	-	-	-	-	-	-	-	-	-	-	-	-	-
Cyanide (Free)	mg/L	0.009784	0.2	-	-	-	-	-	-	-	-	-	-	-	-	-	-	-	-
Iron	mg/L	0.369	-	0.19	0.23	0%	-	0.18	0.19	0%	-	0.25	0.38	5%	-	0.19	0.19	0%	-
Lead	mg/L	0.001	0.01	0.000069	0.000090	0%	0%	0.000062	0.000066	0%	0%	0.000084	0.0001	0%	0%	0.000063	0.000064	0%	0%
Magnesium	mg/L	2.003	-	1.6	2.0	0%	-	1.5	1.5	0%	-	2.0	3.1	62%	-	1.5	1.5	0%	-
Manganese	mg/L	0.7	-	0.070	0.089	0%	-	0.065	0.069	0%	-	0.09	0.14	0%	-	0.067	0.068	0%	-
Molybdenum	mg/L	0.073	-	0.0014	0.0019	0%	-	0.0013	0.0014	0%	-	0.0017	0.003	0%	-	0.0013	0.0013	0%	-
Nickel	mg/L	0.025	-	0.0017	0.0022	0%	-	0.0016	0.0017	0%	-	0.002248	0.0035	0%	-	0.0017	0.0017	0%	-
Nitrate	mg/L	13	10	0.066	0.084	0%	0%	0.064	0.067	0%	0%	0.09	0.14	0%	0%	0.067	0.068	0%	0%
Phosphorus (Total)	mg/L	0.035	-	0.026	0.036	15%	-	0.022	0.024	0%	-	0.028	0.047	26%	-	0.020	0.021	0%	-
Potassium	mg/L	373	-	0.71	1.0	0%	-	0.60	0.66	0%	-	0.8	1.3	0%	-	0.55	0.56	0%	-
Sodium	mg/L	1.3365	-	1.2	1.5	27%	-	1.1	1.2	0%	-	1.5	2.4	78%	-	1.1	1.2	0%	-
Strontium	mg/L	0.026	-	0.027	0.037	51%	-	0.024	0.026	0%	-	0.031	0.050	81%	-	0.023	0.023	0%	-
Sulphate	mg/L	218	-	3.7	4.7	0%	-	3.4	3.6	0%	-	4.7	7.3	0%	-	3.5	3.6	0%	-
Uranium	mg/L	0.015	0.02	0.0017	0.0024	0%	0%	0.0015	0.0016	0%	0%	0.0019	0.0032	0%	0%	0.0014	0.0014	0%	0%
Vanadium	mg/L	0.006	-	0.0014	0.0018	0%	-	0.0012	0.0013	0%	-	0.0017	0.0027	0%	-	0.0012	0.0013	0%	-
Zinc	mg/L	0.032	-	0.011	0.014	0%	-	0.0099	0.0104	0%	-	0.014	0.021	0%	-	0.010	0.010	0%	-

Notes:
 Med - Median Annual Concentration
 Max - Maximum Annual Concentration
 % > Aquatic Health Benchmark and % > Human Health Drinking Water Guideline - percentage of days during the climate year that the concentration is greater than the Aquatic Health Benchmark and Human Health Drinking Water Guideline, respectively.
0.001 - denotes concentrations that are greater than the Aquatic Health Benchmark.
0.001 - denotes concentrations that are greater than the Human Health Benchmark.

(a) Aquatic Health Benchmark - The benchmark is equal to the most recent of the PWQO or CWQG (or the BCMOE guideline for parameters without a PWQO or CWQG) or the upper limit of background (95th percentile), whichever is higher (with the exception of cyanide, which has a site-specific guideline). If no guideline exists, then background was used as the benchmark.

(b) Human Health Drinking Water Guideline - The guideline is equal to the ODWS and CDWQG (where the same). For arsenic, the guideline is equal to the CDWQG. For nitrate, the benchmark is equal to the ODWS.

TABLE B3
WATER QUALITY MODELING RESULTS: POST-CLOSURE PHASE STAGE I, 1:25-YEAR WET CONDITION - MOLLIE RIVER WATERSHED
CÔTÉ GOLD PROJECT

Parameter	Units	Aquatic Health Benchmark ^(a)	Human Health Benchmark ^(b)	MOLLIE RIVER WATERSHED																			
				Chester Lake				Clam Lake				Little Clam Lake				Bagsverd Lake (South)				Weeduck Lake			
				Med	Max	% > Aquatic Health Benchmark	% > Human Health Benchmark	Med	Max	% > Aquatic Health Benchmark	% > Human Health Benchmark	Med	Max	% > Aquatic Health Benchmark	% > Human Health Benchmark	Med	Max	% > Aquatic Health Benchmark	% > Human Health Benchmark	Med	Max	% > Aquatic Health Benchmark	% > Human Health Benchmark
Aluminum	mg/L	0.1182	-	0.048	0.054	0%	-	0.049	0.052	0%	-	0.050	0.076	0%	-	0.050	0.056	0%	-	0.050	0.054	0%	-
Ammonia (Total)	mg/L	6.89	-	0.050	0.056	0%	-	0.052	0.055	0%	-	0.053	0.079	0%	-	0.053	0.059	0%	-	0.053	0.057	0%	-
Ammonia (Un-ionized)	mg/L	0.019	-	0.00082	0.0003	0%	-	0.00089	0.00035	0%	-	0.00091	0.00038	0%	-	0.00010	0.00038	0%	-	0.00094	0.00036	0%	-
Antimony	mg/L	0.02	0.006	0.0004	0.0004	0%	0%	0.00036	0.00040	0%	0%	0.00036	0.00056	0%	0%	0.00036	0.00039	0%	0%	0.00036	0.00038	0%	0%
Arsenic	mg/L	0.005	0.01	0.0018	0.0021	0%	0%	0.0018	0.0020	0%	0%	0.0018	0.0029	0%	0%	0.0019	0.0021	0%	0%	0.0019	0.0020	0%	0%
Barium	mg/L	1.0	1	0.0062	0.0070	0%	0%	0.0063	0.0068	0%	0%	0.0064	0.010	0%	0%	0.0065	0.0072	0%	0%	0.0065	0.0069	0%	0%
Boron	mg/L	1.5	5	0.0053	0.0060	0%	0%	0.0054	0.0058	0%	0%	0.0055	0.0084	0%	0%	0.0056	0.0062	0%	0%	0.0056	0.0059	0%	0%
Cadmium	mg/L	0.000058	0.005	0.000021	0.000024	0%	0%	0.000021	0.000023	0%	0%	0.000022	0.000033	0%	0%	0.000022	0.000025	0%	0%	0.000022	0.000023	0%	0%
Calcium	mg/L	10.465	-	9.8	11	15%	-	9.5	10	0%	-	9.5	15	3%	-	9.5	10	0%	-	9.5	10	0%	-
Chloride	mg/L	120	-	0.80	0.92	0%	-	0.80	0.88	0%	-	0.82	1.3	0%	-	0.84	0.92	0%	-	0.83	0.89	0%	-
Cobalt	mg/L	0.0025	-	0.00028	0.00032	0%	-	0.00029	0.00031	0%	-	0.00030	0.00045	0%	-	0.00030	0.00033	0%	-	0.00030	0.00032	0%	-
Copper	mg/L	0.005	-	0.0012	0.0014	0%	-	0.0012	0.0013	0%	-	0.0012	0.0019	0%	-	0.0012	0.0014	0%	-	0.0012	0.0013	0%	-
Cyanide (Total)	mg/L	-	-	-	-	-	-	-	-	-	-	-	-	-	-	-	-	-	-	-	-	-	-
Cyanide (Free)	mg/L	0.009784	0.2	-	-	-	-	-	-	-	-	-	-	-	-	-	-	-	-	-	-	-	-
Iron	mg/L	0.369	-	0.17	0.19	0%	-	0.18	0.19	0%	-	0.18	0.27	0%	-	0.18	0.20	0%	-	0.18	0.20	0%	-
Lead	mg/L	0.001	0.01	0.00006	0.00006	0%	0%	0.000057	0.000062	0%	0%	0.000058	0.000090	0%	0%	0.000059	0.000066	0%	0%	0.000059	0.000063	0%	0%
Magnesium	mg/L	2.003	-	1.4	1.6	0%	-	1.4	1.5	0%	-	1.5	2.2	1%	-	1.5	1.6	0%	-	1.5	1.6	0%	-
Manganese	mg/L	0.7	-	0.061	0.069	0%	-	0.062	0.067	0%	-	0.064	0.097	0%	-	0.065	0.072	0%	-	0.064	0.068	0%	-
Molybdenum	mg/L	0.073	-	0.0011	0.0013	0%	-	0.0011	0.0013	0%	-	0.0012	0.0018	0%	-	0.0012	0.0013	0%	-	0.0012	0.0013	0%	-
Nickel	mg/L	0.025	-	0.0015	0.0018	0%	-	0.0016	0.0017	0%	-	0.0016	0.0025	0%	-	0.0016	0.0018	0%	-	0.0016	0.0018	0%	-
Nitrate	mg/L	13	10	0.062	0.070	0%	0%	0.064	0.068	0%	0%	0.066	0.098	0%	0%	0.066	0.074	0%	0%	0.066	0.070	0%	0%
Phosphorus (Total)	mg/L	0.035	-	0.019	0.022	0%	-	0.018	0.020	0%	-	0.018	0.028	0%	-	0.018	0.020	0%	-	0.018	0.019	0%	-
Potassium	mg/L	373	-	0.51	0.59	0%	-	0.49	0.53	0%	-	0.486	0.751	0%	-	0.48	0.52	0%	-	0.477	0.515	0%	-
Sodium	mg/L	1.3365	-	1.0	1.2	0%	-	1.1	1.1	0%	-	1.1	1.7	2%	-	1.1	1.2	0%	-	1.1	1.2	0%	-
Strontium	mg/L	0.026	-	0.021	0.024	0%	-	0.021	0.022	0%	-	0.021	0.032	2%	-	0.021	0.023	0%	-	0.021	0.022	0%	-
Sulphate	mg/L	218	-	3.2	3.6	0%	-	3.3	3.5	0%	-	3.3	5.1	0%	-	3.4	3.7	0%	-	3.4	3.6	0%	-
Uranium	mg/L	0.015	0.02	0.0013	0.0015	0%	0%	0.0013	0.0014	0%	0%	0.0013	0.0020	0%	0%	0.0013	0.0014	0%	0%	0.0013	0.0014	0%	0%
Vanadium	mg/L	0.006	-	0.0011	0.0013	0%	-	0.0011	0.0012	0%	-	0.0011	0.0018	0%	-	0.0012	0.0013	0%	-	0.0012	0.0012	0%	-
Zinc	mg/L	0.032	-	0.0092	0.010	0%	-	0.0094	0.010	0%	-	0.0097	0.015	0%	-	0.0098	0.011	0%	-	0.0097	0.010	0%	-

Notes:
 Med - Median Annual Concentration
 Max - Maximum Annual Concentration
 % > Aquatic Health Benchmark and % > Human Health Drinking Water Guideline - percentage of days during the climate year that the concentration is greater than the Aquatic Health Benchmark and Human Health Drinking Water Guideline, respectively.
0.001 - denotes concentrations that are greater than the Aquatic Health Benchmark.
0.001 - denotes concentrations that are greater than the Human Health Drinking Water Guideline.

(a) Aquatic Health Benchmark - The benchmark is equal to the most recent of the PWQO or CWQG (or the BCMOE guideline for parameters without a PWQO or CWQG) or the upper limit of background (95th percentile), whichever is higher (with the exception of cyanide, which has a site-specific guideline). If no guideline exists, then background was used as the benchmark.

(b) Human Health Drinking Water Guideline - The guideline is equal to the ODWS and CDWQG (where the same). For arsenic, the guideline is equal to the CDWQG. For nitrate, the benchmark is equal to the ODWS.

TABLE B3
WATER QUALITY MODELING RESULTS: POST-CLOSURE PHASE STAGE I, 1:25-YEAR WET CONDITION - MOLLIE RIVER WATERSHED
CÔTÉ GOLD PROJECT

Parameter	Units	Aquatic Health Benchmark ^(a)	Human Health Benchmark ^(b)	MOLLIE RIVER WATERSHED															
				Three Duck Lakes (Upper/Middle)				Three Duck Lakes (Lower)				Delaney Lake				Dividing Lake			
				Med	Max	% > Aquatic Health Benchmark	% > Human Health Benchmark	Med	Max	% > Aquatic Health Benchmark	% > Human Health Benchmark	Med	Max	% > Aquatic Health Benchmark	% > Human Health Benchmark	Med	Max	% > Aquatic Health Benchmark	% > Human Health Benchmark
Aluminum	mg/L	0.1182	-	0.049	0.061	0%	-	0.050	0.052	0%	-	0.060	0.08	0%	-	0.052	0.053	0%	-
Ammonia (Total)	mg/L	6.89	-	0.051	0.063	0%	-	0.052	0.054	0%	-	0.064	0.08	0%	-	0.054	0.054	0%	-
Ammonia (Un-ionized)	mg/L	0.019	-	0.00010	0.00041	0%	-	0.000088	0.00034	0%	-	0.00013	0.00047	0%	-	0.000092	0.00036	0%	-
Antimony	mg/L	0.02	0.006	0.00039	0.00062	0%	0%	0.00044	0.00048	0%	0%	0.00042	0.0006	0%	0%	0.00043	0.00045	0%	0%
Arsenic	mg/L	0.005	0.01	0.0019	0.0027	0%	0%	0.0021	0.0022	0%	0%	0.0022	0.0031	0%	0%	0.0021	0.0022	0%	0%
Barium	mg/L	1.0	1	0.0063	0.0081	0%	0%	0.0067	0.0070	0%	0%	0.0078	0.010	0%	0%	0.0068	0.0069	0%	0%
Boron	mg/L	1.5	5	0.0054	0.0069	0%	0%	0.0057	0.0059	0%	0%	0.0067	0.009	0%	0%	0.0058	0.0059	0%	0%
Cadmium	mg/L	0.000058	0.005	0.000021	0.000027	0%	0%	0.000022	0.000023	0%	0%	0.000026	0.00003	0%	0%	0.000023	0.000023	0%	0%
Calcium	mg/L	10.465	-	9.8	15	38%	-	11	12	59%	-	11	16	65%	-	11	11	100%	-
Chloride	mg/L	120	-	0.83	1.1	0%	-	0.90	0.93	0%	-	1.0	1.4	0%	-	0.90	0.92	0%	-
Cobalt	mg/L	0.0025	-	0.00029	0.00037	0%	-	0.00030	0.00032	0%	-	0.00036	0.00047	0%	-	0.00031	0.00032	0%	-
Copper	mg/L	0.005	-	0.0012	0.0017	0%	-	0.0013	0.0014	0%	-	0.0015	0.0020	0%	-	0.0013	0.0014	0%	-
Cyanide (Total)	mg/L	-	-	-	-	-	-	-	-	-	-	-	-	-	-	-	-	-	-
Cyanide (Free)	mg/L	0.009784	0.2	-	-	-	-	-	-	-	-	-	-	-	-	-	-	-	-
Iron	mg/L	0.369	-	0.18	0.22	0%	-	0.18	0.19	0%	-	0.22	0.28	0%	-	0.19	0.19	0%	-
Lead	mg/L	0.001	0.01	0.000058	0.000076	0%	0%	0.000063	0.000065	0%	0%	0.000071	0.0001	0%	0%	0.000063	0.000064	0%	0%
Magnesium	mg/L	2.003	-	1.4	1.8	0%	-	1.5	1.5	0%	-	1.8	2.3	37%	-	1.5	1.5	0%	-
Manganese	mg/L	0.7	-	0.063	0.079	0%	-	0.065	0.068	0%	-	0.077	0.10	0%	-	0.067	0.068	0%	-
Molybdenum	mg/L	0.073	-	0.0012	0.0016	0%	-	0.0013	0.0013	0%	-	0.0014	0.0019	0%	-	0.0013	0.0013	0%	-
Nickel	mg/L	0.025	-	0.0016	0.0020	0%	-	0.0016	0.0017	0%	-	0.0020	0.0025	0%	-	0.0017	0.0017	0%	-
Nitrate	mg/L	13	10	0.064	0.078	0%	0%	0.065	0.067	0%	0%	0.079	0.10	0%	0%	0.067	0.068	0%	0%
Phosphorus (Total)	mg/L	0.035	-	0.019	0.029	0%	-	0.021	0.023	0%	-	0.022	0.031	0%	-	0.021	0.022	0%	-
Potassium	mg/L	373	-	0.515	0.812	0%	-	0.577	0.626	0%	-	0.57	0.8	0%	-	0.56	0.59	0%	-
Sodium	mg/L	1.3365	-	1.1	1.3	4%	-	1.1	1.2	0%	-	1.3	1.7	49%	-	1.1	1.2	0%	-
Strontium	mg/L	0.026	-	0.021	0.030	25%	-	0.023	0.025	0%	-	0.025	0.035	45%	-	0.023	0.024	0%	-
Sulphate	mg/L	218	-	3.3	4.2	0%	-	3.4	3.6	0%	-	4.0	5.3	0%	-	3.5	3.6	0%	-
Uranium	mg/L	0.015	0.02	0.0013	0.0019	0%	0%	0.0015	0.0016	0%	0%	0.0015	0.0022	0%	0%	0.0015	0.0015	0%	0%
Vanadium	mg/L	0.006	-	0.0012	0.0015	0%	-	0.0013	0.0013	0%	-	0.0014	0.0019	0%	-	0.0013	0.0013	0%	-
Zinc	mg/L	0.032	-	0.0095	0.012	0%	-	0.010	0.010	0%	-	0.012	0.015	0%	-	0.010	0.010	0%	-

Notes:
 Med - Median Annual Concentration
 Max - Maximum Annual Concentration
 % > Aquatic Health Benchmark and % > Human Health Drinking Water Guideline - percentage of days during the climate year that the concentration is greater than the Aquatic Health Benchmark and Human Health Drinking Water Guideline, respectively.
0.001 - denotes concentrations that are greater than the Aquatic Health Benchmark.
0.001 - denotes concentrations that are greater than the Human Health Drinking Water Guideline.

(a) Aquatic Health Benchmark - The benchmark is equal to the most recent of the PWQO or CWQG (or the BCMOE guideline for parameters without a PWQO or CWQG) or the upper limit of background (95th percentile), whichever is higher (with the exception of cyanide, which has a site-specific guideline). If no guideline exists, then background was used as the benchmark.

(b) Human Health Drinking Water Guideline - The guideline is equal to the ODWS and CDWQG (where the same). For arsenic, the guideline is equal to the CDWQG. For nitrate, the benchmark is equal to the ODWS.

TABLE B4
WATER QUALITY MODELING RESULTS: POST-CLOSURE PHASE STAGE I, AVERAGE YEAR CONDITION - MESOMIKENDA LAKE WATERSHED
CÔTÉ GOLD PROJECT

Parameter	Units	Aquatic Health Benchmark ^(a)	Human Health Benchmark ^(b)	MESOMIKENDA LAKE WATERSHED																							
				Bagsverd Lake				Unnamed Lake #1				Bagsverd Creek (Closed Polishing Pond Discharge Point)				Bagsverd Creek (Outflow to Neville Lake)				Neville Lake				Mesomikenda Lake (Upper Basin)			
				Med	Max	% > Aquatic Health Benchmark	% > Human Health Benchmark	Med	Max	% > Aquatic Health Benchmark	% > Human Health Benchmark	Med	Max	% > Aquatic Health Benchmark	% > Human Health Benchmark	Med	Max	% > Aquatic Health Benchmark	% > Human Health Benchmark	Med	Max	% > Aquatic Health Benchmark	% > Human Health Benchmark	Med	Max	% > Aquatic Health Benchmark	% > Human Health Benchmark
Aluminum	mg/L	0.1182	-	0.053	0.056	0%	-	0.054	0.069	0%	-	0.054	0.069	0%	-	0.054	0.069	0%	-	0.061	0.066	0%	-	0.043	0.044	0%	-
Ammonia (Total)	mg/L	6.89	-	0.073	0.074	0%	-	0.087	0.117	0%	-	0.086	0.117	0%	-	0.084	0.117	0%	-	0.069	0.074	0%	-	0.047	0.049	0%	-
Ammonia (Un-ionized)	mg/L	0.019	-	0.00012	0.00043	0%	-	0.00016	0.00067	0%	-	0.00015	0.00067	0%	-	0.00015	0.00067	0%	-	0.00012	0.00045	0%	-	0.00008	0.00032	0%	-
Antimony	mg/L	0.02	0.006	0.00029	0.00030	0%	0%	0.00030	0.00038	0%	0%	0.00030	0.00038	0%	0%	0.00030	0.00038	0%	0%	0.00033	0.00036	0%	0%	0.0002353	0.000242	0%	0%
Arsenic	mg/L	0.005	0.01	0.0017	0.0018	0%	0%	0.0018	0.0023	0%	0%	0.0018	0.0023	0%	0%	0.0018	0.0023	0%	0%	0.0020	0.0021	0%	0%	0.0014	0.0015	0%	0%
Barium	mg/L	1.0	1	0.0068	0.0071	0%	0%	0.0070	0.0090	0%	0%	0.0070	0.0090	0%	0%	0.0070	0.0090	0%	0%	0.0076	0.0082	0%	0%	0.0054	0.0056	0%	0%
Boron	mg/L	1.5	5	0.0058	0.0061	0%	0%	0.0059	0.0075	0%	0%	0.0059	0.0075	0%	0%	0.0059	0.0075	0%	0%	0.0066	0.0071	0%	0%	0.0047	0.0048	0%	0%
Cadmium	mg/L	0.000058	0.005	0.000023	0.000024	0%	0%	0.000023	0.000030	0%	0%	0.000024	0.000030	0%	0%	0.000023	0.000030	0%	0%	0.000026	0.000029	0%	0%	0.000019	0.000019	0%	0%
Calcium	mg/L	10.465	-	9	9	0%	-	8.8	11	10%	-	8.8	11	11%	-	8.8	11	11%	-	9.7	10	0%	-	6.9	7.0	0%	-
Chloride	mg/L	120	-	0.89	0.92	0%	-	0.97	1.24	0%	-	0.97	1.24	0%	-	0.96	1.24	0%	-	0.95	1.03	0%	-	0.67	0.69	0%	-
Cobalt	mg/L	0.0025	-	0.00031	0.00032	0%	-	0.00032	0.00041	0%	-	0.00032	0.00041	0%	-	0.00032	0.00041	0%	-	0.00035	0.00038	0%	-	0.00025	0.00026	0%	-
Copper	mg/L	0.005	-	0.0013	0.0014	0%	-	0.0015	0.0019	0%	-	0.0015	0.0019	0%	-	0.0015	0.0019	0%	-	0.0014	0.0015	0%	-	0.0010	0.0010	0%	-
Cyanide (Total)	mg/L	-	-	0.0063	0.0077	-	-	0.0105	0.0167	-	-	0.0100	0.0167	-	-	0.0096	0.0166	-	-	0.0032	0.0037	-	-	0.0017	0.0017	-	-
Cyanide (Free)	mg/L	0.009784	0.2	0.001153	0.001510	0%	0%	0.0022	0.0036	0%	0%	0.0020	0.0036	0%	0%	0.0019	0.0036	0%	0%	0.00033	0.00045	0%	0%	0.000078	0.000087	0%	0%
Iron	mg/L	0.369	-	0.20	0.21	0%	-	0.20	0.26	0%	-	0.20	0.26	0%	-	0.20	0.26	0%	-	0.23	0.24	0%	-	0.16	0.16	0%	-
Lead	mg/L	0.001	0.01	0.00006	0.00006	0%	0%	0.000061	0.000078	0%	0%	0.000061	0.000078	0%	0%	0.000061	0.000078	0%	0%	0.000068	0.000073	0%	0%	0.000048	0.000050	0%	0%
Magnesium	mg/L	2.003	-	1.6	1.7	0%	-	1.7	2.2	11%	-	1.7	2.2	11%	-	1.7	2.2	11%	-	1.8	1.9	0%	-	1.3	1.3	0%	-
Manganese	mg/L	0.7	-	0.067	0.070	0%	-	0.068	0.087	0%	-	0.068	0.087	0%	-	0.068	0.087	0%	-	0.077	0.083	0%	-	0.054	0.056	0%	-
Molybdenum	mg/L	0.073	-	0.0013	0.0013	0%	-	0.0014	0.0019	0%	-	0.0014	0.0019	0%	-	0.0014	0.0019	0%	-	0.0014	0.0015	0%	-	0.0009	0.0010	0%	-
Nickel	mg/L	0.025	-	0.0018	0.0018	0%	-	0.0018	0.0023	0%	-	0.0018	0.0023	0%	-	0.0018	0.0023	0%	-	0.0020	0.0022	0%	-	0.0014	0.0015	0%	-
Nitrate	mg/L	13	10	0.07	0.07	0%	0%	0.07	0.09	0%	0%	0.07	0.09	0%	0%	0.07	0.09	0%	0%	0.08	0.09	0%	0%	0.06	0.06	0%	0%
Phosphorus (Total)	mg/L	0.035	-	0.016	0.016	0%	-	0.016	0.020	0%	-	0.016	0.020	0%	-	0.016	0.020	0%	-	0.018	0.019	0%	-	0.013	0.013	0%	-
Potassium	mg/L	373	-	0.47	0.47	0%	-	0.53	0.70	0%	-	0.53	0.70	0%	-	0.52	0.70	0%	-	0.47	0.51	0%	-	0.33	0.34	0%	-
Sodium	mg/L	1.3365	-	1.4	1.4	71%	-	1.7	2.2	83%	-	1.7	2.2	83%	-	1.6	2.2	78%	-	1.4	1.5	70%	-	1.0	1.0	0%	-
Strontium	mg/L	0.026	-	0.020	0.021	0%	-	0.020	0.026	2%	-	0.020	0.026	1%	-	0.020	0.026	1%	-	0.023	0.024	0%	-	0.016	0.016	0%	-
Sulphate	mg/L	218	-	4.2	4.2	0%	-	4.8	6.3	0%	-	4.8	6.3	0%	-	4.7	6.3	0%	-	4.1	4.5	0%	-	2.9	3.0	0%	-
Uranium	mg/L	0.015	0.02	0.0012	0.0012	0%	0%	0.0012	0.0015	0%	0%	0.0012	0.0015	0%	0%	0.0012	0.0015	0%	0%	0.0013	0.0014	0%	0%	0.0009	0.0010	0%	0%
Vanadium	mg/L	0.006	-	0.0012	0.0012	0%	-	0.0012	0.0015	0%	-	0.0012	0.0015	0%	-	0.0012	0.0015	0%	-	0.0013	0.0014	0%	-	0.0009	0.0010	0%	-
Zinc	mg/L	0.032	-	0.010	0.011	0%	-	0.010	0.013	0%	-	0.010	0.013	0%	-	0.010	0.013	0%	-	0.012	0.012	0%	-	0.008	0.008	0%	-

Notes:
 Med - Median Annual Concentration
 Max - Maximum Annual Concentration
 % > Aquatic Health Benchmark and % > Human Health Drinking Water Guideline - percentage of days during the climate year that the concentration is greater than the Aquatic Health Benchmark and Human Health Drinking Water Guideline, respectively.

0.001 - denotes concentrations that are greater than the Aquatic Health Benchmark.
 0.001 - denotes concentrations that are greater than the Human Health Drinking Water Guideline.

(a) Aquatic Health Benchmark - The benchmark is equal to the most recent of the PWQO or CWQG (or the BCMOE guideline for parameters without a PWQO or CWQG) or the upper limit of background (95th percentile), whichever is higher (with the exception of free cyanide, which has a site-specific guideline). If no guideline exists, then background was used as the benchmark.

(b) Human Health Drinking Water Guideline - The guideline is equal to the ODWS and CDWQG (where the same). For arsenic, the guideline is equal to the CDWQG. For nitrate, the benchmark is equal to the ODWS.

TABLE B5
WATER QUALITY MODELING RESULTS: POST-CLOSURE PHASE STAGE I, 1:25 YEAR DRY CONDITION - MESOMIKENDA LAKE WATERSHED
CÔTÉ GOLD PROJECT

Parameter	Units	Aquatic Health Benchmark ^(a)	Human Health Benchmark ^(b)	MESOMIKENDA LAKE WATERSHED																							
				Bagsverd Lake				Unnamed Lake #1				Bagsverd Creek (Closed Polishing Pond Discharge Point)				Bagsverd Creek (Outflow to Neville Lake)				Neville Lake				Mesomikenda Lake (Upper Basin)			
				Med	Max	% > Aquatic Health Benchmark	% > Human Health Benchmark	Med	Max	% > Aquatic Health Benchmark	% > Human Health Benchmark	Med	Max	% > Aquatic Health Benchmark	% > Human Health Benchmark	Med	Max	% > Aquatic Health Benchmark	% > Human Health Benchmark	Med	Max	% > Aquatic Health Benchmark	% > Human Health Benchmark	Med	Max	% > Aquatic Health Benchmark	% > Human Health Benchmark
Aluminum	mg/L	0.1182	-	0.054	0.059	0%	-	0.056	0.099	0%	-	0.056	0.099	0%	-	0.054	0.097	0%	-	0.060	0.072	0%	-	0.044	0.044	0%	-
Ammonia (Total)	mg/L	6.89	-	0.075	0.082	0%	-	0.095	0.193	0%	-	0.095	0.193	0%	-	0.083	0.187	0%	-	0.069	0.081	0%	-	0.048	0.049	0%	-
Ammonia (Un-ionized)	mg/L	0.019	-	0.00014	0.00050	0%	-	0.00024	0.0011	0%	-	0.00020	0.0011	0%	-	0.00010	0.0011	0%	-	0.00013	0.00051	0%	-	0.00008	0.00032	0%	-
Antimony	mg/L	0.02	0.006	0.00030	0.00033	0%	0%	0.00031	0.00055	0%	0%	0.00031	0.00055	0%	0%	0.00030	0.00054	0%	0%	0.00033	0.00039	0%	0%	0.0002385	0.0002416	0%	0%
Arsenic	mg/L	0.005	0.01	0.0018	0.0019	0%	0%	0.0018	0.0032	0%	0%	0.0018	0.0032	0%	0%	0.0018	0.0032	0%	0%	0.0020	0.0023	0%	0%	0.0014	0.0014	0%	0%
Barium	mg/L	1.0	1	0.0069	0.0076	0%	0%	0.0072	0.0131	0%	0%	0.0072	0.0131	0%	0%	0.0070	0.0127	0%	0%	0.0075	0.0090	0%	0%	0.0055	0.0056	0%	0%
Boron	mg/L	1.5	5	0.0059	0.0065	0%	0%	0.0060	0.0107	0%	0%	0.0061	0.0107	0%	0%	0.0059	0.0105	0%	0%	0.0065	0.0078	0%	0%	0.0048	0.0048	0%	0%
Cadmium	mg/L	0.000058	0.005	0.000023	0.000026	0%	0%	0.000024	0.000043	0%	0%	0.000024	0.000043	0%	0%	0.000024	0.000042	0%	0%	0.000026	0.000031	0%	0%	0.000019	0.000019	0%	0%
Calcium	mg/L	10.465	-	9	10	0%	-	9.1	16	35%	-	9.1	16	35%	-	8.8	16	20%	-	9.5	11	29%	-	6.9	7.0	0%	-
Chloride	mg/L	120	-	0.9	1.0	0%	-	1.0	1.9	0%	-	1.0	1.9	0%	-	1.0	1.8	0%	-	0.95	1.1	0%	-	0.68	0.69	0%	-
Cobalt	mg/L	0.0025	-	0.00031	0.00035	0%	-	0.00033	0.00059	0%	-	0.00033	0.00059	0%	-	0.00032	0.00057	0%	-	0.00035	0.00041	0%	-	0.00025	0.00026	0%	-
Copper	mg/L	0.005	-	0.0013	0.0015	0%	-	0.0015	0.0029	0%	-	0.0015	0.0029	0%	-	0.0014	0.0029	0%	-	0.0014	0.0016	0%	-	0.0010	0.0010	0%	-
Cyanide (Total)	mg/L	-	-	0.0074	0.0082	-	-	0.0128	0.0322	-	-	0.0125	0.0322	-	-	0.0094	0.0309	-	-	0.0036	0.0042	-	-	0.0017	0.0017	-	-
Cyanide (Free)	mg/L	0.009784	0.2	0.001410	0.001605	0%	0%	0.0027	0.0073	0%	0%	0.0026	0.0073	0%	0%	0.0019	0.0070	0%	0%	0.0003814	0.000529	0%	0%	0.000084	0.000087	0%	0%
Iron	mg/L	0.369	-	0.20	0.22	0%	-	0.21	0.37	0%	-	0.21	0.37	0%	-	0.20	0.36	0%	-	0.22	0.27	0%	-	0.16	0.16	0%	-
Lead	mg/L	0.001	0.01	0.00006	0.00007	0%	0%	0.000062	0.000112	0%	0%	0.000062	0.000112	0%	0%	0.000061	0.00011	0%	0%	6.7E-05	8.0E-05	0%	0%	0.000049	0.000049	0%	0%
Magnesium	mg/L	2.003	-	1.6	1.8	0%	-	1.8	3.2	35%	-	1.8	3.2	35%	-	1.7	3.2	20%	-	1.8	2.1	20%	-	1.3	1.3	0%	-
Manganese	mg/L	0.7	-	0.068	0.075	0%	-	0.070	0.125	0%	-	0.070	0.125	0%	-	0.068	0.122	0%	-	0.076	0.090	0%	-	0.055	0.056	0%	-
Molybdenum	mg/L	0.073	-	0.0013	0.0014	0%	-	0.0015	0.0029	0%	-	0.0015	0.0029	0%	-	0.0014	0.0028	0%	-	0.0013	0.0016	0%	-	0.0010	0.0010	0%	-
Nickel	mg/L	0.025	-	0.0018	0.0020	0%	-	0.0019	0.0034	0%	-	0.0019	0.0034	0%	-	0.0018	0.0033	0%	-	0.0020	0.0024	0%	-	0.0014	0.0015	0%	-
Nitrate	mg/L	13	10	0.07	0.08	0%	0%	0.07	0.13	0%	0%	0.07	0.13	0%	0%	0.07	0.13	0%	0%	0.08	0.10	0%	0%	0.06	0.06	0%	0%
Phosphorus (Total)	mg/L	0.035	-	0.016	0.017	0%	-	0.016	0.029	0%	-	0.016	0.029	0%	-	0.016	0.028	0%	-	0.017	0.021	0%	-	0.013	0.013	0%	-
Potassium	mg/L	373	-	0.47	0.52	0%	-	0.56	1.10	0%	-	0.56	1.10	0%	-	0.52	1.07	0%	-	0.47	0.56	0%	-	0.33	0.34	0%	-
Sodium	mg/L	1.3365	-	1.5	1.6	85%	-	1.8	3.6	90%	-	1.8	3.6	90%	-	1.6	3.5	73%	-	1.4	1.6	81%	-	1.0	1.0	0%	-
Strontium	mg/L	0.026	-	0.020	0.022	0%	-	0.021	0.038	28%	-	0.021	0.038	28%	-	0.020	0.037	15%	-	0.022	0.027	12%	-	0.016	0.016	0%	-
Sulphate	mg/L	218	-	4.2	4.7	0%	-	5.1	10.1	0%	-	5.1	10.1	0%	-	4.6	9.8	0%	-	4.1	4.9	0%	-	2.9	3.0	0%	-
Uranium	mg/L	0.015	0.02	0.0012	0.0013	0%	0%	0.0012	0.0022	0%	0%	0.0012	0.0022	0%	0%	0.0012	0.0022	0%	0%	0.0013	0.0016	0%	0%	0.0010	0.0010	0%	0%
Vanadium	mg/L	0.006	-	0.0012	0.0013	0%	-	0.0012	0.0022	0%	-	0.0012	0.0022	0%	-	0.0012	0.0021	0%	-	0.0013	0.0016	0%	-	0.0010	0.0010	0%	-
Zinc	mg/L	0.032	-	0.010	0.011	0%	-	0.011	0.019	0%	-	0.011	0.019	0%	-	0.010	0.018	0%	-	0.011	0.014	0%	-	0.008	0.008	0%	-

Notes:
 Med - Median Annual Concentration
 Max - Maximum Annual Concentration
 % > Aquatic Health Benchmark and % > Human Health Drinking Water Guideline - percentage of days during the climate year that the concentration is greater than the Aquatic Health Benchmark and Human Health Drinking Water Guideline, respectively.

0.001 - denotes concentrations that are greater than the Aquatic Health Benchmark.
 0.001 - denotes concentrations that are greater than the Human Health Drinking Water Guideline.

(a) Aquatic Health Benchmark - The benchmark is equal to the most recent of the PWQO or CWQG (or the BCMOE guideline for parameters without a PWQO or CWQG) or the upper limit of background (95th percentile), whichever is higher (with the exception of free cyanide, which has a site-specific guideline). If no guideline exists, then background was used as the benchmark.

(b) Human Health Drinking Water Guideline - The guideline is equal to the ODWS and CDWQG (where the same). For arsenic, the guideline is equal to the CDWQG. For nitrate, the benchmark is equal to the ODWS.

TABLE B6
WATER QUALITY MODELING RESULTS: POST-CLOSURE PHASE STAGE I, 1:25 YEAR WET CONDITION - MESOMIKENDA LAKE WATERSHED
CÔTÉ GOLD PROJECT

Parameter	Units	Aquatic Health Benchmark ^(a)	Human Health Benchmark ^(b)	MESOMIKENDA LAKE WATERSHED																							
				Bagsverd Lake				Unnamed Lake #1				Bagsverd Creek (Closed Polishing Pond Discharge Point)				Bagsverd Creek (Outflow to Neville Lake)				Neville Lake				Mesomikenda Lake (Upper Basin)			
				Med	Max	% > Aquatic Health Benchmark	% > Human Health Benchmark	Med	Max	% > Aquatic Health Benchmark	% > Human Health Benchmark	Med	Max	% > Aquatic Health Benchmark	% > Human Health Benchmark	Med	Max	% > Aquatic Health Benchmark	% > Human Health Benchmark	Med	Max	% > Aquatic Health Benchmark	% > Human Health Benchmark	Med	Max	% > Aquatic Health Benchmark	% > Human Health Benchmark
Aluminum	mg/L	0.1182	-	0.053	0.055	0%	-	0.053	0.071	0%	-	0.054	0.071	0%	-	0.053	0.071	0%	-	0.059	0.065	0%	-	0.045	0.046	0%	-
Ammonia (Total)	mg/L	6.89	-	0.069	0.076	0%	-	0.074	0.123	0%	-	0.074	0.123	0%	-	0.072	0.123	0%	-	0.066	0.074	0%	-	0.049	0.050	0%	-
Ammonia (Un-ionized)	mg/L	0.019	-	0.00012	0.00043	0%	-	0.00016	0.00069	0%	-	0.00015	0.00069	0%	-	0.00015	0.00069	0%	-	0.00012	0.00046	0%	-	0.00009	0.00034	0%	-
Antimony	mg/L	0.02	0.006	0.00029	0.00030	0%	0%	0.00029	0.00039	0%	0%	0.00030	0.00039	0%	0%	0.00029	0.00039	0%	0%	0.00032	0.00036	0%	0%	0.0002433	0.0002511	0%	0%
Arsenic	mg/L	0.005	0.01	0.0017	0.0018	0%	0%	0.0017	0.0023	0%	0%	0.0018	0.0023	0%	0%	0.0017	0.0023	0%	0%	0.0019	0.0021	0%	0%	0.0015	0.0015	0%	0%
Barium	mg/L	1.0	1	0.0068	0.0070	0%	0%	0.0068	0.0092	0%	0%	0.0069	0.0092	0%	0%	0.0067	0.0092	0%	0%	0.0074	0.0082	0%	0%	0.0056	0.0058	0%	0%
Boron	mg/L	1.5	5	0.0058	0.0060	0%	0%	0.0058	0.0077	0%	0%	0.0059	0.0077	0%	0%	0.0058	0.0077	0%	0%	0.0065	0.0071	0%	0%	0.0049	0.0050	0%	0%
Cadmium	mg/L	0.000058	0.005	0.000023	0.000024	0%	0%	0.000023	0.000031	0%	0%	0.000023	0.000031	0%	0%	0.000023	0.000031	0%	0%	0.000026	0.000028	0%	0%	0.000019	0.000020	0%	0%
Calcium	mg/L	10.465	-	9	9	0%	-	8.5	12	7%	-	8.7	12	7%	-	8.5	12	7%	-	9.4	10	0%	-	7.1	7.3	0%	-
Chloride	mg/L	120	-	0.88	0.90	0%	-	0.89	1.28	0%	-	0.89	1.28	0%	-	0.87	1.28	0%	-	0.93	1.02	0%	-	0.69	0.72	0%	-
Cobalt	mg/L	0.0025	-	0.00031	0.00032	0%	-	0.00031	0.00041	0%	-	0.00031	0.00041	0%	-	0.00031	0.00042	0%	-	0.00034	0.00038	0%	-	0.00026	0.00027	0%	-
Copper	mg/L	0.005	-	0.0013	0.0014	0%	-	0.0013	0.0020	0%	-	0.0013	0.0020	0%	-	0.0013	0.0020	0%	-	0.0014	0.0015	0%	-	0.0010	0.0010	0%	-
Cyanide (Total)	mg/L	-	-	0.0055	0.0079	-	-	0.0078	0.0181	-	-	0.0075	0.0181	-	-	0.0068	0.0180	-	-	0.0028	0.0039	-	-	0.0017	0.0018	-	-
Cyanide (Free)	mg/L	0.009784	0.2	0.000959	0.001555	0%	0%	0.0015	0.0040	0%	0%	0.0015	0.0040	0%	0%	0.0013	0.0040	0%	0%	0.0002136	0.000536	0%	0%	0.000081	0.000092	0%	0%
Iron	mg/L	0.369	-	0.20	0.20	0%	-	0.20	0.26	0%	-	0.20	0.26	0%	-	0.20	0.26	0%	-	0.22	0.24	0%	-	0.17	0.17	0%	-
Lead	mg/L	0.001	0.01	0.00006	0.00006	0%	0%	0.000059	0.000079	0%	0%	0.000060	0.000079	0%	0%	0.000059	0.00008	0%	0%	6.6E-05	7.3E-05	0%	0%	0.000050	0.000051	0%	0%
Magnesium	mg/L	2.003	-	1.6	1.6	0%	-	1.6	2.2	7%	-	1.6	2.2	7%	-	1.6	2.2	7%	-	1.7	1.9	0%	-	1.3	1.3	0%	-
Manganese	mg/L	0.7	-	0.067	0.069	0%	-	0.067	0.089	0%	-	0.068	0.089	0%	-	0.067	0.089	0%	-	0.075	0.082	0%	-	0.056	0.058	0%	-
Molybdenum	mg/L	0.073	-	0.0013	0.0013	0%	-	0.0013	0.0019	0%	-	0.0013	0.0019	0%	-	0.0013	0.0019	0%	-	0.0013	0.0014	0%	-	0.0010	0.0010	0%	-
Nickel	mg/L	0.025	-	0.0018	0.0018	0%	-	0.0018	0.0024	0%	-	0.0018	0.0024	0%	-	0.0018	0.0024	0%	-	0.0020	0.0021	0%	-	0.0015	0.0015	0%	-
Nitrate	mg/L	13	10	0.07	0.07	0%	0%	0.07	0.09	0%	0%	0.07	0.09	0%	0%	0.07	0.09	0%	0%	0.08	0.09	0%	0%	0.06	0.06	0%	0%
Phosphorus (Total)	mg/L	0.035	-	0.015	0.016	0%	-	0.015	0.021	0%	-	0.016	0.021	0%	-	0.015	0.021	0%	-	0.017	0.019	0%	-	0.013	0.013	0%	-
Potassium	mg/L	373	-	0.45	0.48	0%	-	0.47	0.72	0%	-	0.47	0.72	0%	-	0.46	0.72	0%	-	0.46	0.50	0%	-	0.34	0.35	0%	-
Sodium	mg/L	1.3365	-	1.4	1.5	57%	-	1.4	2.3	74%	-	1.4	2.3	74%	-	1.4	2.3	63%	-	1.3	1.5	47%	-	1.0	1.0	0%	-
Strontium	mg/L	0.026	-	0.020	0.021	0%	-	0.020	0.027	3%	-	0.020	0.027	3%	-	0.020	0.027	3%	-	0.022	0.024	0%	-	0.017	0.017	0%	-
Sulphate	mg/L	218	-	4.0	4.3	0%	-	4.2	6.6	0%	-	4.2	6.6	0%	-	4.1	6.6	0%	-	4.0	4.4	0%	-	3.0	3.1	0%	-
Uranium	mg/L	0.015	0.02	0.0012	0.0012	0%	0%	0.0012	0.0016	0%	0%	0.0012	0.0016	0%	0%	0.0012	0.0016	0%	0%	0.0013	0.0014	0%	0%	0.0010	0.0010	0%	0%
Vanadium	mg/L	0.006	-	0.0012	0.0012	0%	-	0.0012	0.0015	0%	-	0.0012	0.0015	0%	-	0.0012	0.0015	0%	-	0.0013	0.0014	0%	-	0.0010	0.0010	0%	-
Zinc	mg/L	0.032	-	0.010	0.010	0%	-	0.010	0.013	0%	-	0.010	0.013	0%	-	0.010	0.013	0%	-	0.011	0.012	0%	-	0.008	0.009	0%	-

Notes:
 Med - Median Annual Concentration
 Max - Maximum Annual Concentration
 % > Aquatic Health Benchmark and % > Human Health Drinking Water Guideline - percentage of days during the climate year that the concentration is greater than the Aquatic Health Benchmark and Human Health Drinking Water Guideline, respectively.

0.001 - denotes concentrations that are greater than the Aquatic Health Benchmark.
 0.001 - denotes concentrations that are greater than the Human Health Drinking Water Guideline.

(a) Aquatic Health Benchmark - The benchmark is equal to the most recent of the PWQO or CWQG (or the BCMOE guideline for parameters without a PWQO or CWQG) or the upper limit of background (95th percentile), whichever is higher (with the exception of free cyanide, which has a site-specific guideline). If no guideline exists, then background was used as the benchmark.

(b) Human Health Drinking Water Guideline - The guideline is equal to the ODWS and CDWQG (where the same). For arsenic, the guideline is equal to the CDWQG. For nitrate, the benchmark is equal to the ODWS.

TABLE B7
WATER QUALITY MODELING RESULTS: POST-CLOSURE PHASE STAGE I, AVERAGE YEAR CONDITION - PROJECT SITE COMPONENTS
CÔTÉ GOLD PROJECT

Parameter	Units	MMER	MINE SITE WATER MANAGEMENT COMPONENTS					
			Mine Rock Area Drainage		Reclaim Pond		Polishing Pond	
			Avg	Max	Med	Max	Med	Max
Aluminum	mg/L	-	0.056	1.1	0.048	0.049	0.065	0.07
Ammonia (Total)	mg/L	-	-	-	0.052	0.052	0.07	0.07
Ammonia (Un-ionized)	mg/L	-	-	-	0.00089	0.00035	0.00012	0.00047
Antimony	mg/L	-	0.0049	0.098	0.00026	0.00027	0.00036	0.00037
Arsenic	mg/L	0.5	0.014	0.29	0.0016	0.0016	0.0021	0.0022
Barium	mg/L	-	0.017	0.35	0.0061	0.0061	0.0082	0.0085
Boron	mg/L	-	0.011	0.23	0.0053	0.0053	0.0071	0.0074
Cadmium	mg/L	-	0.000030	0.00059	0.000021	0.000021	0.000028	0.000030
Calcium	mg/L	-	93	1857	7.7	7.7	10	11
Chloride	mg/L	-	3.9	79	0.75	0.75	1.0	1.1
Cobalt	mg/L	-	0.00066	0.013	0.0003	0.0003	0.0004	0.0004
Copper	mg/L	0.3	0.0068	0.14	0.0011	0.0011	0.0015	0.0015
Cyanide (Total)	mg/L	1	-	-	-	-	-	-
Cyanide (Free)	mg/L	-	-	-	-	-	-	-
Iron	mg/L	-	0.029	0.59	0.18	0.18	0.24	0.25
Lead	mg/L	0.2	0.00023	0.0045	0.00005	0.00005	0.00007	0.00008
Magnesium	mg/L	-	1.9	38	1	1	1.9	2.0
Manganese	mg/L	-	0.12	2.4	0.061	0.061	0.08	0.09
Molybdenum	mg/L	-	0.0059	0.119	0.0011	0.0011	0.0014	0.0015
Nickel	mg/L	0.5	0.0013	0.027	0.0016	0.0016	0.0021	0.0022
Nitrate	mg/L	-	-	-	0.065	0.07	0.09	0.09
Phosphorus (Total)	mg/L	-	0.20	4.1	0.014	0.014	0.02	0.02
Potassium	mg/L	-	6.0	120	0.36	0.37	0.49	0.51
Sodium	mg/L	-	1.6	33	1.1	1.1	1.4	1.5
Strontium	mg/L	-	0.15	3.0	0.02	0.02	0.02	0.03
Sulphate	mg/L	-	7.1	142	3.2	3.2	4.3	4.5
Uranium	mg/L	-	0.011	0.23	0.0011	0.0011	0.001	0.001
Vanadium	mg/L	-	0.005	0.10	0.0011	0.0011	0.0014	0.001
Zinc	mg/L	0.5	0.020	0.39	0.0092	0.0093	0.012	0.013

Notes:

Med - Median Annual Concentration

Max - Maximum Annual Concentration

Avg - Average Annual Concentration. Applied for the Mine Rock Drainage and Ore Stockpile Drainage, rather than the median, to account for days with zero discharge.

Dashes indicate that parameter was not modelled.

0.001

- denotes concentrations that are greater than the MMER.

TABLE B8
WATER QUALITY MODELING RESULTS: POST-CLOSURE PHASE STAGE I, 1:25-YEAR DRY CONDITION - PROJECT SITE COMPONENTS
CÔTÉ GOLD PROJECT

Parameter	Units	MMER	MINE SITE WATER MANAGEMENT COMPONENTS					
			Mine Rock Area Drainage		Reclaim Pond		Polishing Pond	
			Avg	Max	Med	Max	Med	Max
Aluminum	mg/L	-	0.080	3.6	0.049	0.050	0.066	0.07
Ammonia (Total)	mg/L	-	-	-	0.052	0.053	0.07	0.08
Ammonia (Un-ionized)	mg/L	-	-	-	0.000090	0.00035	0.00013	0.00050
Antimony	mg/L	-	0.0070	0.313	0.00026	0.00027	0.00036	0.00040
Arsenic	mg/L	0.5	0.021	0.93	0.0016	0.0016	0.0022	0.0024
Barium	mg/L	-	0.025	1.12	0.0061	0.0062	0.0083	0.0093
Boron	mg/L	-	0.016	0.73	0.0053	0.0054	0.0072	0.0081
Cadmium	mg/L	-	0.000043	0.00191	0.000021	0.000022	0.000029	0.000032
Calcium	mg/L	-	134	5959	7.7	7.9	11	12
Chloride	mg/L	-	5.7	252	0.75	0.77	1.0	1.1
Cobalt	mg/L	-	0.00096	0.043	0.0003	0.0003	0.0004	0.0004
Copper	mg/L	0.3	0.0099	0.44	0.0011	0.0011	0.0015	0.0017
Cyanide (Total)	mg/L	1	-	-	-	-	-	-
Cyanide (Free)	mg/L	-	-	-	-	-	-	-
Iron	mg/L	-	0.042	1.89	0.18	0.18	0.25	0.27
Lead	mg/L	0.2	0.00033	0.0146	0.00005	0.00006	0.00007	0.00008
Magnesium	mg/L	-	2.8	123	1	1	1.9	2.2
Manganese	mg/L	-	0.17	7.7	0.061	0.062	0.08	0.09
Molybdenum	mg/L	-	0.0085	0.381	0.0011	0.0011	0.0014	0.0016
Nickel	mg/L	0.5	0.0019	0.085	0.0016	0.0016	0.0022	0.0024
Nitrate	mg/L	-	-	-	0.065	0.07	0.09	0.10
Phosphorus (Total)	mg/L	-	0.29	13.1	0.014	0.014	0.02	0.02
Potassium	mg/L	-	8.7	387	0.36	0.37	0.50	0.56
Sodium	mg/L	-	2.4	106	1.1	1.1	1.4	1.6
Strontium	mg/L	-	0.22	9.7	0.02	0.02	0.02	0.03
Sulphate	mg/L	-	10.2	456	3.2	3.3	4.4	4.9
Uranium	mg/L	-	0.017	0.74	0.0011	0.0011	0.001	0.002
Vanadium	mg/L	-	0.007	0.33	0.0011	0.0011	0.0014	0.002
Zinc	mg/L	0.5	0.028	1.26	0.0092	0.0094	0.013	0.014

Notes:

Med - Median Annual Concentration

Max - Maximum Annual Concentration

Avg - Average Annual Concentration. Applied for the Mine Rock Drainage and Ore Stockpile Drainage, rather than the median, to account for days with zero discharge.

Dashes indicate that parameter was not modelled.

0.001

- denotes concentrations that are greater than the MMER.

TABLE B9
WATER QUALITY MODELING RESULTS: POST-CLOSURE PHASE STAGE I, 1:25-YEAR WET CONDITION - PROJECT SITE COMPONENTS
CÔTÉ GOLD PROJECT

Parameter	Units	MMER	MINE SITE WATER MANAGEMENT COMPONENTS					
			Mine Rock Area Drainage		Reclaim Pond		Polishing Pond	
			Avg	Max	Med	Max	Med	Max
Aluminum	mg/L	-	0.075	3.0	0.048	0.049	0.065	0.07
Ammonia (Total)	mg/L	-	-	-	0.052	0.052	0.07	0.07
Ammonia (Un-ionized)	mg/L	-	-	-	0.000089	0.00035	0.00012	0.00047
Antimony	mg/L	-	0.0066	0.266	0.00026	0.00027	0.00035	0.00037
Arsenic	mg/L	0.5	0.019	0.79	0.0016	0.0016	0.0021	0.0022
Barium	mg/L	-	0.023	0.95	0.0060	0.0061	0.0081	0.0084
Boron	mg/L	-	0.015	0.62	0.0053	0.0053	0.0071	0.0073
Cadmium	mg/L	-	0.000040	0.00162	0.000021	0.000021	0.000028	0.000029
Calcium	mg/L	-	125	5069	7.6	7.7	10	11
Chloride	mg/L	-	5.3	215	0.75	0.75	1.0	1.0
Cobalt	mg/L	-	0.00089	0.036	0.0003	0.0003	0.0004	0.0004
Copper	mg/L	0.3	0.0092	0.37	0.0011	0.0011	0.0015	0.0015
Cyanide (Total)	mg/L	1	-	-	-	-	-	-
Cyanide (Free)	mg/L	-	-	-	-	-	-	-
Iron	mg/L	-	0.040	1.61	0.18	0.18	0.24	0.25
Lead	mg/L	0.2	0.00031	0.0124	0.00005	0.00005	0.00007	0.00008
Magnesium	mg/L	-	2.6	105	1	1	1.9	2.0
Manganese	mg/L	-	0.16	6.6	0.061	0.061	0.08	0.08
Molybdenum	mg/L	-	0.0080	0.324	0.0011	0.0011	0.0014	0.0015
Nickel	mg/L	0.5	0.0018	0.072	0.0016	0.0016	0.0021	0.0022
Nitrate	mg/L	-	-	-	0.064	0.07	0.09	0.09
Phosphorus (Total)	mg/L	-	0.28	11.2	0.014	0.014	0.02	0.02
Potassium	mg/L	-	8.1	329	0.36	0.37	0.49	0.50
Sodium	mg/L	-	2.2	90	1.0	1.1	1.4	1.5
Strontium	mg/L	-	0.20	8.2	0.02	0.02	0.02	0.02
Sulphate	mg/L	-	9.6	388	3.2	3.2	4.3	4.4
Uranium	mg/L	-	0.015	0.63	0.0011	0.0011	0.001	0.001
Vanadium	mg/L	-	0.007	0.28	0.0011	0.0011	0.0014	0.001
Zinc	mg/L	0.5	0.026	1.07	0.0092	0.0093	0.012	0.013

Notes:

Med - Median Annual Concentration

Max - Maximum Annual Concentration

Avg - Average Annual Concentration. Applied for the Mine Rock Drainage and Ore Stockpile Drainage, rather than the median, to account for days with zero discharge.

Dashes indicate that parameter was not modelled.

0.001

- denotes concentrations that are greater than the MMER.



APPENDIX C

Water Quality Model Results - Post-closure Phase Stage II

TABLE C1
WATER QUALITY MODELING RESULTS: POST-CLOSURE PHASE STAGE II, AVERAGE YEAR CONDITION - MOLLIE RIVER WATERSHED
CÔTÉ GOLD PROJECT

Parameter	Units	Aquatic Health Benchmark ^(a)	Human Health Benchmark ^(b)	MOLLIE RIVER WATERSHED															
				Chester Lake				Clam Lake				Côté Pit Lake				Weeduck Lake			
				Med	Max	% > Aquatic Health Benchmark	% > Human Health Benchmark	Med	Max	% > Aquatic Health Benchmark	% > Human Health Benchmark	Med	Max	% > Aquatic Health Benchmark	% > Human Health Benchmark	Med	Max	% > Aquatic Health Benchmark	% > Human Health Benchmark
Aluminum	mg/L	0.1182	-	0.047	0.051	0%	-	0.049	0.050	0%	-	0.051	0.052	0%	-	0.046	0.046	0%	-
Ammonia (Total)	mg/L	6.89	-	0.048	0.051	0%	-	0.050	0.051	0%	-	0.050	0.052	0%	-	0.049	0.049	0%	-
Ammonia (Un-ionized)	mg/L	0.019	-	0.00008	0.00032	0%	-	0.00009	0.00033	0%	-	0.00009	0.00034	0%	-	0.00	0.00	0%	-
Antimony	mg/L	0.02	0.006	0.00051	0.000629	0%	0%	0.00047	0.00054	0%	0%	0.00080	0.000823	0%	0%	0.00025	0.00025	0%	0%
Arsenic	mg/L	0.005	0.01	0.0023	0.0025	0%	0%	0.0022	0.0024	0%	0%	0.0031	0.0032	0%	0%	0.0015	0.0015	0%	0%
Barium	mg/L	1.0	1	0.0065	0.0070	0%	0%	0.0066	0.0069	0%	0%	0.0076	0.0078	0%	0%	0.0057	0.0057	0%	0%
Boron	mg/L	1.5	5	0.0054	0.0058	0%	0%	0.0056	0.0058	0%	0%	0.0062	0.0063	0%	0%	0.0050	0.0050	0%	0%
Cadmium	mg/L	0.000058	0.005	0.000021	0.000022	0%	0%	0.000022	0.000022	0%	0%	0.000023	0.000023	0%	0%	0.000020	0.000020	0%	0%
Calcium	mg/L	10.465	-	12.3	14	100%	-	11.5	13	100%	-	17.6	18.1	100%	-	7.3	7.3	0%	-
Chloride	mg/L	120	-	0.90	0.97	0%	-	0.89	0.95	0%	-	1.14	1.17	0%	-	0.71	0.71	0%	-
Cobalt	mg/L	0.0025	-	0.00029	0.00031	0%	-	0.00030	0.00031	0%	-	0.00033	0.00034	0%	-	0.00027	0.00027	0%	-
Copper	mg/L	0.005	-	0.0014	0.0015	0%	-	0.0013	0.0014	0%	-	0.0018	0.0018	0%	-	0.0010	0.0010	0%	-
Cyanide (Total)	mg/L	-	-	-	-	-	-	-	-	-	-	-	-	-	-	-	-	-	-
Cyanide (Free)	mg/L	0.009784	0.2	-	-	-	-	-	-	-	-	-	-	-	-	-	-	-	-
Iron	mg/L	0.369	-	0.17	0.18	0%	-	0.17	0.18	0%	-	0.17	0.17	0%	-	0.17	0.17	0%	-
Lead	mg/L	0.001	0.01	0.000062	0.000066	0%	0%	0.000062	0.000065	0%	0%	0.000076	0.000078	0%	0%	0.000051	0.000051	0%	0%
Magnesium	mg/L	2.003	-	1.4	1.5	0%	-	1.4	1.5	0%	-	1.5	1.6	0%	-	1.3	1.3	0%	-
Manganese	mg/L	0.7	-	0.062	0.067	0%	-	0.064	0.066	0%	-	0.070	0.072	0%	-	0.058	0.058	0%	-
Molybdenum	mg/L	0.073	-	0.0013	0.0014	0%	-	0.0013	0.0014	0%	-	0.0016	0.0017	0%	-	0.0010	0.0010	0%	-
Nickel	mg/L	0.025	-	0.0015	0.0016	0%	-	0.0016	0.0016	0%	-	0.0016	0.0017	0%	-	0.0015	0.0015	0%	-
Nitrate	mg/L	13	10	0.059	0.063	0%	0%	0.062	0.063	0%	0%	0.068	0.071	0%	0%	0.061	0.061	0%	0%
Phosphorus (Total)	mg/L	0.035	-	0.024	0.029	0%	-	0.023	0.025	0%	-	0.036	0.037	100%	-	0.013	0.013	0%	-
Potassium	mg/L	373	-	0.67	0.81	0%	-	0.62	0.70	0%	-	1.02	1.05	0%	-	0.34	0.34	0%	-
Sodium	mg/L	1.3365	-	1.0	1.1	0%	-	1.1	1.1	0%	-	1.2	1.2	0%	-	1.00	1.00	0%	-
Strontium	mg/L	0.026	-	0.025	0.028	32%	-	0.024	0.026	0%	-	0.034	0.035	100%	-	0.017	0.017	0%	-
Sulphate	mg/L	218	-	3.3	3.5	0%	-	3.4	3.5	0%	-	3.7	3.8	0%	-	3.01	3.01	0%	-
Uranium	mg/L	0.015	0.02	0.0016	0.0018	0%	0%	0.0015	0.0017	0%	0%	0.0023	0.0023	0%	0%	0.0010	0.0010	0%	0%
Vanadium	mg/L	0.006	-	0.0013	0.0013	0%	-	0.0012	0.0013	0%	-	0.0016	0.0016	0%	-	0.0010	0.0010	0%	-
Zinc	mg/L	0.032	-	0.0094	0.010	0%	-	0.0097	0.010	0%	-	0.0107	0.011	0%	-	0.0087	0.0087	0%	-

Notes:
 Med - Median Annual Concentration
 Max - Maximum Annual Concentration
 % > Aquatic Health Benchmark and % > Human Health Drinking Water Guideline - percentage of days during the climate year that the concentration is greater than the Aquatic Health Benchmark and Human Health Drinking Water Guideline, respectively.

0.001 - denotes concentrations that are greater than the Aquatic Health Benchmark.
 0.001 - denotes concentrations that are greater than the Human Health Drinking Water Guideline.

(a) Aquatic Health Benchmark - The benchmark is equal to the most recent of the PWQO or CWQG (or the BCMOE guideline for parameters without a PWQO or CWQG) or the upper limit of background (95th percentile), whichever is higher (with the exception of cyanide, which site-specific guideline). If no guideline exists, then background was used as the benchmark.

(b) Human Health Drinking Water Guideline - The guideline is equal to the ODWS and CDWQG (where the same). For arsenic, the guideline is equal to the CDWQG. For nitrate, the benchmark is equal to the ODWS.

TABLE C1
WATER QUALITY MODELING RESULTS: POST-CLOSURE PHASE STAGE II, AVERAGE YEAR CONDITION - MOLLIE RIVER WATERSHED
CÔTÉ GOLD PROJECT

Parameter	Units	Aquatic Health Benchmark ^(a)	Human Health Benchmark ^(b)	MOLLIE RIVER WATERSHED															
				Three Duck Lakes (Upper/Middle)				Three Duck Lakes (Lower)				Delaney Lake				Dividing Lake			
				Med	Max	% > Aquatic Health Benchmark	% > Human Health Benchmark	Med	Max	% > Aquatic Health Benchmark	% > Human Health Benchmark	Med	Max	% > Aquatic Health Benchmark	% > Human Health Benchmark	Med	Max	% > Aquatic Health Benchmark	% > Human Health Benchmark
Aluminum	mg/L	0.1182	-	0.049	0.062	0%	-	0.051	0.052	0%	-	0.063	0.081	0%	-	0.052	0.052	0%	-
Ammonia (Total)	mg/L	6.89	-	0.048	0.060	0%	-	0.050	0.051	0%	-	0.066	0.083	0%	-	0.052	0.052	0%	-
Ammonia (Un-ionized)	mg/L	0.019	-	0.000094	0.00040	0%	-	0.00008	0.00033	0%	-	0.00013	0.00048	0%	-	0.00009	0.00034	0%	-
Antimony	mg/L	0.02	0.006	0.00082	0.00108	0%	0%	0.00083	0.00087	0%	0%	0.00048	0.00068	0%	0%	0.00081	0.00081	0%	0%
Arsenic	mg/L	0.005	0.01	0.0031	0.0040	0%	0%	0.0032	0.0033	0%	0%	0.0024	0.0033	0%	0%	0.0031	0.0032	0%	0%
Barium	mg/L	1.0	1	0.0075	0.0094	0%	0%	0.0076	0.0079	0%	0%	0.0082	0.0106	0%	0%	0.0077	0.0077	0%	0%
Boron	mg/L	1.5	5	0.0061	0.0076	0%	0%	0.0062	0.0064	0%	0%	0.0070	0.0091	0%	0%	0.0063	0.0063	0%	0%
Cadmium	mg/L	0.000058	0.005	0.000022	0.000028	0%	0%	0.000023	0.000023	0%	0%	0.000028	0.000035	0%	0%	0.000023	0.000023	0%	0%
Calcium	mg/L	10.465	-	17.9	23.1	100%	-	18.2	18.9	100%	-	12.5	17	76%	-	17.8	18.0	100%	-
Chloride	mg/L	120	-	1.14	1.44	0%	-	1.16	1.20	0%	-	1.08	1.41	0%	-	1.15	1.16	0%	-
Cobalt	mg/L	0.0025	-	0.00033	0.00041	0%	-	0.00034	0.00035	0%	-	0.00038	0.00049	0%	-	0.00034	0.00034	0%	-
Copper	mg/L	0.005	-	0.0018	0.0023	0%	-	0.0018	0.0019	0%	-	0.0016	0.0021	0%	-	0.0018	0.0018	0%	-
Cyanide (Total)	mg/L	-	-	-	-	-	-	-	-	-	-	-	-	-	-	-	-	-	-
Cyanide (Free)	mg/L	0.009784	0.2	-	-	-	-	-	-	-	-	-	-	-	-	-	-	-	-
Iron	mg/L	0.369	-	0.16	0.20	0%	-	0.17	0.17	0%	-	0.23	0.29	0%	-	0.17	0.17	0%	-
Lead	mg/L	0.001	0.01	0.000075	0.000095	0%	0%	0.000077	0.000079	0%	0%	0.000076	0.000099	0%	0%	0.000077	0.000077	0%	0%
Magnesium	mg/L	2.003	-	1.48	1.9	0%	-	1.5	1.6	0%	-	1.8	2.4	32%	-	1.5	1.6	0%	-
Manganese	mg/L	0.7	-	0.069	0.086	0%	-	0.070	0.072	0%	-	0.081	0.104	0%	-	0.071	0.072	0%	-
Molybdenum	mg/L	0.073	-	0.00165	0.0021	0%	-	0.0017	0.0017	0%	-	0.0015	0.0020	0%	-	0.0017	0.0017	0%	-
Nickel	mg/L	0.025	-	0.0016	0.0020	0%	-	0.0016	0.0017	0%	-	0.0021	0.0026	0%	-	0.0016	0.0017	0%	-
Nitrate	mg/L	13	10	0.064	0.079	0%	0%	0.067	0.070	0%	0%	0.082	0.10	0%	0%	0.069	0.071	0%	0%
Phosphorus (Total)	mg/L	0.035	-	0.037	0.048	59%	-	0.037	0.039	100%	-	0.024	0.034	0%	-	0.037	0.037	100%	-
Potassium	mg/L	373	-	1.04	1.37	0%	-	1.06	1.10	0%	-	0.64	0.91	0%	-	1.03	1.04	0%	-
Sodium	mg/L	1.3365	-	1.1	1.4	18%	-	1.2	1.2	0%	-	1.4	1.8	61%	-	1.2	1.2	0%	-
Strontium	mg/L	0.026	-	0.034	0.043	83%	-	0.034	0.036	100%	-	0.027	0.037	58%	-	0.034	0.034	100%	-
Sulphate	mg/L	218	-	3.7	4.6	0%	-	3.8	3.9	0%	-	4.3	5.5	0%	-	3.8	3.8	0%	-
Uranium	mg/L	0.015	0.02	0.0023	0.0030	0%	0%	0.0023	0.0024	0%	0%	0.0017	0.0023	0%	0%	0.0023	0.0023	0%	0%
Vanadium	mg/L	0.006	-	0.0016	0.0020	0%	-	0.0016	0.0016	0%	-	0.0015	0.0020	0%	-	0.0016	0.0016	0%	-
Zinc	mg/L	0.032	-	0.0105	0.013	0%	-	0.0108	0.011	0%	-	0.0123	0.016	0%	-	0.0109	0.011	0%	-

Notes:

Med - Median Annual Concentration

Max - Maximum Annual Concentration

% > Aquatic Health Benchmark and % > Human Health Drinking Water Guideline - percentage of days during the climate year that the concentration is greater than the Aquatic Health Benchmark and Human Health Drinking Water Guideline, respectively.

0.001 - denotes concentrations that are greater than the Aquatic Health Benchmark.

0.001 - denotes concentrations that are greater than the Human Health Drinking Water Guideline.

(a) Aquatic Health Benchmark - The benchmark is equal to the most recent of the PWQO or CWQG (or the BCMOE guideline for parameters without a PWQO or CWQG) or the upper limit of background (95th percentile), whichever is higher (with the exception of cyanide, which has a site-specific guideline). If no guideline exists, then background was used as the benchmark.

(b) Human Health Drinking Water Guideline - The guideline is equal to the ODWS and CDWQG (where the same). For arsenic, the guideline is equal to the CDWQG. For nitrate, the benchmark is equal to the ODWS.

TABLE C2
WATER QUALITY MODELING RESULTS: POST-CLOSURE PHASE STAGE II, 1:25-YEAR DRY CONDITION - MOLLIE RIVER WATERSHED
CÔTÉ GOLD PROJECT

Parameter	Units	Aquatic Health Benchmark ^(a)	Human Health Benchmark ^(b)	MOLLIE RIVER WATERSHED															
				Chester Lake				Clam Lake				Côté Pit Lake				Weeduck Lake			
				Med	Max	% > Aquatic Health Benchmark	% > Human Health Benchmark	Med	Max	% > Aquatic Health Benchmark	% > Human Health Benchmark	Med	Max	% > Aquatic Health Benchmark	% > Human Health Benchmark	Med	Max	% > Aquatic Health Benchmark	% > Human Health Benchmark
Aluminum	mg/L	0.1182	-	0.049	0.056	0%	-	0.051	0.053	0%	-	0.052	0.053	0%	-	0.046	0.046	0%	-
Ammonia (Total)	mg/L	6.89	-	0.048	0.056	0%	-	0.051	0.053	0%	-	0.048	0.049	0%	-	0.049	0.049	0%	-
Ammonia (Un-ionized)	mg/L	0.019	-	0.00008	0.00032	0%	-	0.00009	0.00034	0%	-	0.00008	0.00032	0%	-	0.00	0.00	0%	-
Antimony	mg/L	0.02	0.006	0.00062	0.000697	0%	0%	0.00056	0.00060	0%	0%	0.00084	0.000863	0%	0%	0.00025	0.00025	0%	0%
Arsenic	mg/L	0.005	0.01	0.0026	0.0027	0%	0%	0.0025	0.0025	0%	0%	0.0032	0.0033	0%	0%	0.0015	0.0015	0%	0%
Barium	mg/L	1.0	1	0.0069	0.0076	0%	0%	0.0069	0.0073	0%	0%	0.0078	0.0079	0%	0%	0.0057	0.0057	0%	0%
Boron	mg/L	1.5	5	0.0057	0.0064	0%	0%	0.0058	0.0061	0%	0%	0.0063	0.0064	0%	0%	0.0050	0.0050	0%	0%
Cadmium	mg/L	0.000058	0.005	0.000022	0.000025	0%	0%	0.000022	0.000023	0%	0%	0.000023	0.000024	0%	0%	0.000020	0.000020	0%	0%
Calcium	mg/L	10.465	-	14.3	15	100%	-	13.4	14	100%	-	18.5	18.9	100%	-	7.3	7.3	0%	-
Chloride	mg/L	120	-	1.00	1.06	0%	-	0.96	1.00	0%	-	1.18	1.20	0%	-	0.71	0.71	0%	-
Cobalt	mg/L	0.0025	-	0.00031	0.00034	0%	-	0.00031	0.00033	0%	-	0.00034	0.00035	0%	-	0.00027	0.00027	0%	-
Copper	mg/L	0.005	-	0.0015	0.0016	0%	-	0.0015	0.0015	0%	-	0.0019	0.0019	0%	-	0.0010	0.0010	0%	-
Cyanide (Total)	mg/L	-	-	-	-	-	-	-	-	-	-	-	-	-	-	-	-	-	-
Cyanide (Free)	mg/L	0.009784	0.2	-	-	-	-	-	-	-	-	-	-	-	-	-	-	-	-
Iron	mg/L	0.369	-	0.17	0.20	0%	-	0.18	0.19	0%	-	0.17	0.17	0%	-	0.17	0.17	0%	-
Lead	mg/L	0.001	0.01	0.000067	0.000072	0%	0%	0.000066	0.000069	0%	0%	0.000078	0.000080	0%	0%	0.000051	0.000051	0%	0%
Magnesium	mg/L	2.003	-	1.5	1.6	0%	-	1.5	1.6	0%	-	1.5	1.6	0%	-	1.3	1.3	0%	-
Manganese	mg/L	0.7	-	0.066	0.073	0%	-	0.067	0.070	0%	-	0.071	0.073	0%	-	0.058	0.058	0%	-
Molybdenum	mg/L	0.073	-	0.0014	0.0015	0%	-	0.0014	0.0014	0%	-	0.0017	0.0017	0%	-	0.0010	0.0010	0%	-
Nickel	mg/L	0.025	-	0.0016	0.0018	0%	-	0.0016	0.0017	0%	-	0.0016	0.0017	0%	-	0.0015	0.0015	0%	-
Nitrate	mg/L	13	10	0.060	0.070	0%	0%	0.063	0.066	0%	0%	0.060	0.061	0%	0%	0.061	0.061	0%	0%
Phosphorus (Total)	mg/L	0.035	-	0.029	0.032	0%	-	0.027	0.028	0%	-	0.038	0.039	100%	-	0.013	0.013	0%	-
Potassium	mg/L	373	-	0.80	0.89	0%	-	0.73	0.77	0%	-	1.08	1.10	0%	-	0.34	0.34	0%	-
Sodium	mg/L	1.3365	-	1.1	1.2	0%	-	1.1	1.2	0%	-	1.2	1.2	0%	-	1.00	1.00	0%	-
Strontium	mg/L	0.026	-	0.028	0.030	94%	-	0.027	0.028	78%	-	0.035	0.036	100%	-	0.017	0.017	0%	-
Sulphate	mg/L	218	-	3.5	3.8	0%	-	3.5	3.7	0%	-	3.8	3.9	0%	-	3.01	3.01	0%	-
Uranium	mg/L	0.015	0.02	0.0019	0.0020	0%	0%	0.0018	0.0018	0%	0%	0.0024	0.0024	0%	0%	0.0010	0.0010	0%	0%
Vanadium	mg/L	0.006	-	0.0014	0.0015	0%	-	0.0013	0.0014	0%	-	0.0016	0.0017	0%	-	0.0010	0.0010	0%	-
Zinc	mg/L	0.032	-	0.0100	0.011	0%	-	0.0101	0.011	0%	-	0.0110	0.011	0%	-	0.0087	0.0087	0%	-

Notes:
 Med - Median Annual Concentration
 Max - Maximum Annual Concentration
 % > Aquatic Health Benchmark and % > Human Health Drinking Water Guideline - percentage of days during the climate year that the concentration is greater than the Aquatic Health Benchmark and Human Health Drinking Water Guideline, respectively.

0.001 - denotes concentrations that are greater than the Aquatic Health Benchmark.
 0.001 - denotes concentrations that are greater than the Human Health Drinking Water Guideline.

(a) Aquatic Health Benchmark - The benchmark is equal to the most recent of the PWQO or CWQG (or the BCMOE guideline for parameters without a PWQO or CWQG) or the upper limit of background (95th percentile), whichever is higher (with the exception of cyanide, which site-specific guideline). If no guideline exists, then background was used as the benchmark.

(b) Human Health Drinking Water Guideline - The guideline is equal to the ODWS and CDWQG (where the same). For arsenic, the guideline is equal to the CDWQG. For nitrate, the benchmark is equal to the ODWS.

TABLE C2
WATER QUALITY MODELING RESULTS: POST-CLOSURE PHASE STAGE II, 1:25-YEAR DRY CONDITION - MOLLIE RIVER WATERSHED
CÔTÉ GOLD PROJECT

Parameter	Units	Aquatic Health Benchmark ^(a)	Human Health Benchmark ^(b)	MOLLIE RIVER WATERSHED															
				Three Duck Lakes (Upper/Middle)				Three Duck Lakes (Lower)				Delaney Lake				Dividing Lake			
				Med	Max	% > Aquatic Health Benchmark	% > Human Health Benchmark	Med	Max	% > Aquatic Health Benchmark	% > Human Health Benchmark	Med	Max	% > Aquatic Health Benchmark	% > Human Health Benchmark	Med	Max	% > Aquatic Health Benchmark	% > Human Health Benchmark
Aluminum	mg/L	0.1182	-	0.054	0.077	0%	-	0.051	0.054	0%	-	0.068	0.105	0%	-	0.053	0.054	0%	-
Ammonia (Total)	mg/L	6.89	-	0.050	0.072	0%	-	0.047	0.049	0%	-	0.070	0.109	0%	-	0.049	0.050	0%	-
Ammonia (Un-ionized)	mg/L	0.019	-	0.000113	0.00043	0%	-	0.00008	0.00031	0%	-	0.00017	0.00060	0%	-	0.00009	0.00033	0%	-
Antimony	mg/L	0.02	0.006	0.00090	0.00124	0%	0%	0.00090	0.00094	0%	0%	0.00062	0.00092	0%	0%	0.00086	0.00087	0%	0%
Arsenic	mg/L	0.005	0.01	0.0034	0.0048	0%	0%	0.0034	0.0036	0%	0%	0.0029	0.0044	0%	0%	0.0033	0.0033	0%	0%
Barium	mg/L	1.0	1	0.0082	0.0115	0%	0%	0.0079	0.0082	0%	0%	0.0091	0.0140	0%	0%	0.0079	0.0081	0%	0%
Boron	mg/L	1.5	5	0.0067	0.0093	0%	0%	0.0063	0.0066	0%	0%	0.0077	0.0119	0%	0%	0.0064	0.0065	0%	0%
Cadmium	mg/L	0.000058	0.005	0.000024	0.000034	0%	0%	0.000023	0.000024	0%	0%	0.000030	0.000046	0%	0%	0.000024	0.000024	0%	0%
Calcium	mg/L	10.465	-	19.7	27.2	100%	-	19.5	20.5	100%	-	15.4	23	90%	-	18.8	19.1	100%	-
Chloride	mg/L	120	-	1.25	1.73	0%	-	1.21	1.27	0%	-	1.22	1.86	0%	-	1.20	1.22	0%	-
Cobalt	mg/L	0.0025	-	0.00036	0.00051	0%	-	0.00034	0.00036	0%	-	0.00041	0.00064	0%	-	0.00035	0.00035	0%	-
Copper	mg/L	0.005	-	0.0020	0.0027	0%	-	0.0019	0.0020	0%	-	0.0018	0.0028	0%	-	0.0019	0.0019	0%	-
Cyanide (Total)	mg/L	-	-	-	-	-	-	-	-	-	-	-	-	-	-	-	-	-	-
Cyanide (Free)	mg/L	0.009784	0.2	-	-	-	-	-	-	-	-	-	-	-	-	-	-	-	-
Iron	mg/L	0.369	-	0.18	0.25	0%	-	0.17	0.17	0%	-	0.24	0.38	3%	-	0.17	0.18	0%	-
Lead	mg/L	0.001	0.01	0.000083	0.000115	0%	0%	0.000080	0.000084	0%	0%	0.000085	0.000130	0%	0%	0.000079	0.000081	0%	0%
Magnesium	mg/L	2.003	-	1.63	2.3	21%	-	1.5	1.6	0%	-	2.0	3.1	46%	-	1.6	1.6	0%	-
Manganese	mg/L	0.7	-	0.075	0.105	0%	-	0.072	0.075	0%	-	0.088	0.136	0%	-	0.073	0.074	0%	-
Molybdenum	mg/L	0.073	-	0.00182	0.0025	0%	-	0.0018	0.0018	0%	-	0.0017	0.0027	0%	-	0.0017	0.0018	0%	-
Nickel	mg/L	0.025	-	0.0017	0.0024	0%	-	0.0016	0.0017	0%	-	0.0022	0.0034	0%	-	0.0017	0.0017	0%	-
Nitrate	mg/L	13	10	0.062	0.089	0%	0%	0.059	0.061	0%	0%	0.087	0.14	0%	0%	0.061	0.062	0%	0%
Phosphorus (Total)	mg/L	0.035	-	0.041	0.056	68%	-	0.040	0.042	100%	-	0.030	0.045	25%	-	0.039	0.039	100%	-
Potassium	mg/L	373	-	1.14	1.58	0%	-	1.15	1.20	0%	-	0.8	1.2	0%	-	1.09	1.11	0%	-
Sodium	mg/L	1.3365	-	1.2	1.7	36%	-	1.2	1.2	0%	-	1.5	2.3	68%	-	1.2	1.2	0%	-
Strontium	mg/L	0.026	-	0.037	0.052	99%	-	0.037	0.038	100%	-	0.032	0.049	73%	-	0.036	0.036	100%	-
Sulphate	mg/L	218	-	4.0	5.6	0%	-	3.8	4.0	0%	-	4.6	7.2	0%	-	3.9	4.0	0%	-
Uranium	mg/L	0.015	0.02	0.0025	0.0035	0%	0%	0.0025	0.0026	0%	0%	0.0020	0.0031	0%	0%	0.0024	0.0025	0%	0%
Vanadium	mg/L	0.006	-	0.0017	0.0024	0%	-	0.0017	0.0017	0%	-	0.0017	0.0026	0%	-	0.0016	0.0017	0%	-
Zinc	mg/L	0.032	-	0.0116	0.016	0%	-	0.0110	0.0115	0%	-	0.013	0.021	0%	-	0.0111	0.011	0%	-

Notes:

Med - Median Annual Concentration

Max - Maximum Annual Concentration

% > Aquatic Health Benchmark and % > Human Health Drinking Water Guideline - percentage of days during the climate year that the concentration is greater than the Aquatic Health Benchmark and Human Health Drinking Water Guideline, respectively.

0.001 - denotes concentrations that are greater than the Aquatic Health Benchmark.

0.001 - denotes concentrations that are greater than the Human Health Drinking Water Guideline.

(a) Aquatic Health Benchmark - The benchmark is equal to the most recent of the PWQO or CWQG (or the BCMOE guideline for parameters without a PWQO or CWQG) or the upper limit of background (95th percentile), whichever is higher (with the exception of cyanide, which has a site-specific guideline). If no guideline exists, then background was used as the benchmark.

(b) Human Health Drinking Water Guideline - The guideline is equal to the ODWS and CDWQG (where the same). For arsenic, the guideline is equal to the CDWQG. For nitrate, the benchmark is equal to the ODWS.

TABLE C3
WATER QUALITY MODELING RESULTS: POST-CLOSURE PHASE STAGE II, 1:25-YEAR WET CONDITION - MOLLIE RIVER WATERSHED
CÔTÉ GOLD PROJECT

Parameter	Units	Aquatic Health Benchmark ^(a)	Human Health Benchmark ^(b)	MOLLIE RIVER WATERSHED															
				Chester Lake				Clam Lake				Côté Pit Lake				Weeduck Lake			
				Med	Max	% > Aquatic Health Benchmark	% > Human Health Benchmark	Med	Max	% > Aquatic Health Benchmark	% > Human Health Benchmark	Med	Max	% > Aquatic Health Benchmark	% > Human Health Benchmark	Med	Max	% > Aquatic Health Benchmark	% > Human Health Benchmark
Aluminum	mg/L	0.1182	-	0.048	0.053	0%	-	0.049	0.052	0%	-	0.052	0.054	0%	-	0.046	0.046	0%	-
Ammonia (Total)	mg/L	6.89	-	0.048	0.054	0%	-	0.050	0.052	0%	-	0.048	0.050	0%	-	0.049	0.049	0%	-
Ammonia (Un-ionized)	mg/L	0.019	-	0.00008	0.00032	0%	-	0.00009	0.00034	0%	-	0.00008	0.00032	0%	-	0.00	0.00	0%	-
Antimony	mg/L	0.02	0.006	0.00053	0.000667	0%	0%	0.00049	0.00053	0%	0%	0.00085	0.000896	0%	0%	0.00025	0.00025	0%	0%
Arsenic	mg/L	0.005	0.01	0.0023	0.0027	0%	0%	0.0022	0.0024	0%	0%	0.0033	0.0034	0%	0%	0.0015	0.0015	0%	0%
Barium	mg/L	1.0	1	0.0065	0.0073	0%	0%	0.0065	0.0070	0%	0%	0.0078	0.0081	0%	0%	0.0057	0.0057	0%	0%
Boron	mg/L	1.5	5	0.0055	0.0061	0%	0%	0.0055	0.0059	0%	0%	0.0063	0.0065	0%	0%	0.0050	0.0050	0%	0%
Cadmium	mg/L	0.000058	0.005	0.000021	0.000023	0%	0%	0.000021	0.000023	0%	0%	0.000023	0.000024	0%	0%	0.000020	0.000020	0%	0%
Calcium	mg/L	10.465	-	12.4	15	96%	-	11.7	13	100%	-	18.7	19.6	100%	-	7.3	7.3	0%	-
Chloride	mg/L	120	-	0.91	1.01	0%	-	0.89	0.96	0%	-	1.18	1.23	0%	-	0.71	0.71	0%	-
Cobalt	mg/L	0.0025	-	0.00029	0.00033	0%	-	0.00029	0.00032	0%	-	0.00034	0.00036	0%	-	0.00027	0.00027	0%	-
Copper	mg/L	0.005	-	0.0014	0.0016	0%	-	0.0013	0.0015	0%	-	0.0019	0.0019	0%	-	0.0010	0.0010	0%	-
Cyanide (Total)	mg/L	-	-	-	-	-	-	-	-	-	-	-	-	-	-	-	-	-	-
Cyanide (Free)	mg/L	0.009784	0.2	-	-	-	-	-	-	-	-	-	-	-	-	-	-	-	-
Iron	mg/L	0.369	-	0.17	0.19	0%	-	0.17	0.18	0%	-	0.17	0.18	0%	-	0.17	0.17	0%	-
Lead	mg/L	0.001	0.01	0.000062	0.000069	0%	0%	0.000061	0.000066	0%	0%	0.000079	0.000082	0%	0%	0.000051	0.000051	0%	0%
Magnesium	mg/L	2.003	-	1.4	1.6	0%	-	1.4	1.5	0%	-	1.6	1.6	0%	-	1.3	1.3	0%	-
Manganese	mg/L	0.7	-	0.062	0.070	0%	-	0.063	0.068	0%	-	0.072	0.074	0%	-	0.058	0.058	0%	-
Molybdenum	mg/L	0.073	-	0.0013	0.0014	0%	-	0.0013	0.0014	0%	-	0.0017	0.0018	0%	-	0.0010	0.0010	0%	-
Nickel	mg/L	0.025	-	0.0015	0.0017	0%	-	0.0016	0.0017	0%	-	0.0016	0.0017	0%	-	0.0015	0.0015	0%	-
Nitrate	mg/L	13	10	0.059	0.067	0%	0%	0.062	0.065	0%	0%	0.060	0.062	0%	0%	0.061	0.061	0%	0%
Phosphorus (Total)	mg/L	0.035	-	0.025	0.031	0%	-	0.023	0.025	0%	-	0.039	0.040	100%	-	0.013	0.013	0%	-
Potassium	mg/L	373	-	0.68	0.86	0%	-	0.64	0.69	0%	-	1.09	1.14	0%	-	0.34	0.34	0%	-
Sodium	mg/L	1.3365	-	1.1	1.2	0%	-	1.1	1.1	0%	-	1.2	1.2	0%	-	1.00	1.00	0%	-
Strontium	mg/L	0.026	-	0.025	0.029	18%	-	0.024	0.026	3%	-	0.035	0.037	100%	-	0.017	0.017	0%	-
Sulphate	mg/L	218	-	3.3	3.7	0%	-	3.3	3.6	0%	-	3.8	4.0	0%	-	3.01	3.01	0%	-
Uranium	mg/L	0.015	0.02	0.0016	0.0019	0%	0%	0.0015	0.0017	0%	0%	0.0024	0.0025	0%	0%	0.0010	0.0010	0%	0%
Vanadium	mg/L	0.006	-	0.0013	0.0014	0%	-	0.0012	0.0013	0%	-	0.0016	0.0017	0%	-	0.0010	0.0010	0%	-
Zinc	mg/L	0.032	-	0.0095	0.011	0%	-	0.0096	0.010	0%	-	0.0110	0.011	0%	-	0.0087	0.0087	0%	-

Notes:
 Med - Median Annual Concentration
 Max - Maximum Annual Concentration
 % > Aquatic Health Benchmark and % > Human Health Drinking Water Guideline - percentage of days during the climate year that the concentration is greater than the Aquatic Health Benchmark and Human Health Drinking Water Guideline, respectively.

0.001 - denotes concentrations that are greater than the Aquatic Health Benchmark.
 0.001 - denotes concentrations that are greater than the Human Health Drinking Water Guideline.

(a) Aquatic Health Benchmark - The benchmark is equal to the most recent of the PWQO or CWQG (or the BCMOE guideline for parameters without a PWQO or CWQG) or the upper limit of background (95th percentile), whichever is higher (with the exception of cyanide, which site-specific guideline). If no guideline exists, then background was used as the benchmark.

(b) Human Health Drinking Water Guideline - The guideline is equal to the ODWS and CDWQG (where the same). For arsenic, the guideline is equal to the CDWQG. For nitrate, the benchmark is equal to the ODWS.

TABLE C3
WATER QUALITY MODELING RESULTS: POST-CLOSURE PHASE STAGE II, 1:25-YEAR WET CONDITION - MOLLIE RIVER WATERSHED
CÔTÉ GOLD PROJECT

Parameter	Units	Aquatic Health Benchmark ^(a)	Human Health Benchmark ^(b)	MOLLIE RIVER WATERSHED															
				Three Duck Lakes (Upper/Middle)				Three Duck Lakes (Lower)				Delaney Lake				Dividing Lake			
				Med	Max	% > Aquatic Health Benchmark	% > Human Health Benchmark	Med	Max	% > Aquatic Health Benchmark	% > Human Health Benchmark	Med	Max	% > Aquatic Health Benchmark	% > Human Health Benchmark	Med	Max	% > Aquatic Health Benchmark	% > Human Health Benchmark
Aluminum	mg/L	0.1182	-	0.051	0.060	0%	-	0.052	0.053	0%	-	0.060	0.077	0%	-	0.053	0.054	0%	-
Ammonia (Total)	mg/L	6.89	-	0.047	0.057	0%	-	0.048	0.049	0%	-	0.062	0.080	0%	-	0.049	0.049	0%	-
Ammonia (Un-ionized)	mg/L	0.019	-	0.00088	0.00037	0%	-	0.00088	0.00032	0%	-	0.00013	0.00046	0%	-	0.00008	0.00033	0%	-
Antimony	mg/L	0.02	0.006	0.00083	0.00108	0%	0%	0.00088	0.00094	0%	0%	0.00045	0.00067	0%	0%	0.00086	0.00090	0%	0%
Arsenic	mg/L	0.005	0.01	0.0032	0.0040	0%	0%	0.0033	0.0035	0%	0%	0.0023	0.0032	0%	0%	0.0033	0.0034	0%	0%
Barium	mg/L	1.0	1	0.0076	0.0090	0%	0%	0.0079	0.0082	0%	0%	0.0078	0.010	0%	0%	0.0079	0.0081	0%	0%
Boron	mg/L	1.5	5	0.0062	0.0073	0%	0%	0.0064	0.0066	0%	0%	0.0067	0.009	0%	0%	0.0064	0.0065	0%	0%
Cadmium	mg/L	0.000058	0.005	0.000023	0.000027	0%	0%	0.000023	0.000024	0%	0%	0.000026	0.000034	0%	0%	0.000024	0.000024	0%	0%
Calcium	mg/L	10.465	-	18.2	23.1	100%	-	19.2	20.5	100%	-	11.8	17	70%	-	18.8	19.7	100%	-
Chloride	mg/L	120	-	1.15	1.39	0%	-	1.20	1.26	0%	-	1.01	1.36	0%	-	1.20	1.24	0%	-
Cobalt	mg/L	0.0025	-	0.00033	0.00040	0%	-	0.00035	0.00036	0%	-	0.00036	0.00046	0%	-	0.00035	0.00036	0%	-
Copper	mg/L	0.005	-	0.0018	0.0022	0%	-	0.0019	0.0020	0%	-	0.0015	0.0020	0%	-	0.0019	0.0020	0%	-
Cyanide (Total)	mg/L	-	-	-	-	-	-	-	-	-	-	-	-	-	-	-	-	-	-
Cyanide (Free)	mg/L	0.009784	0.2	-	-	-	-	-	-	-	-	-	-	-	-	-	-	-	-
Iron	mg/L	0.369	-	0.17	0.20	0%	-	0.17	0.17	0%	-	0.22	0.28	0%	-	0.17	0.17	0%	-
Lead	mg/L	0.001	0.01	0.00077	0.00091	0%	0%	0.00080	0.00083	0%	0%	0.00071	0.00095	0%	0%	0.00079	0.00082	0%	0%
Magnesium	mg/L	2.003	-	1.51	1.8	0%	-	1.6	1.6	0%	-	1.7	2.3	36%	-	1.6	1.6	0%	-
Manganese	mg/L	0.7	-	0.070	0.083	0%	-	0.072	0.074	0%	-	0.077	0.100	0%	-	0.073	0.074	0%	-
Molybdenum	mg/L	0.073	-	0.00168	0.0020	0%	-	0.0017	0.0018	0%	-	0.0014	0.0019	0%	-	0.0017	0.0018	0%	-
Nickel	mg/L	0.025	-	0.0016	0.0019	0%	-	0.0016	0.0017	0%	-	0.0019	0.0025	0%	-	0.0017	0.0017	0%	-
Nitrate	mg/L	13	10	0.059	0.070	0%	0%	0.060	0.061	0%	0%	0.078	0.10	0%	0%	0.061	0.061	0%	0%
Phosphorus (Total)	mg/L	0.035	-	0.037	0.048	64%	-	0.040	0.042	100%	-	0.023	0.033	0%	-	0.039	0.041	100%	-
Potassium	mg/L	373	-	1.06	1.37	0%	-	1.12	1.20	0%	-	0.60	0.88	0%	-	1.09	1.15	0%	-
Sodium	mg/L	1.3365	-	1.2	1.4	11%	-	1.2	1.2	0%	-	1.3	1.7	49%	-	1.2	1.2	0%	-
Strontium	mg/L	0.026	-	0.034	0.043	96%	-	0.036	0.038	100%	-	0.026	0.035	49%	-	0.036	0.037	100%	-
Sulphate	mg/L	218	-	3.7	4.4	0%	-	3.9	4.0	0%	-	4.0	5.2	0%	-	3.9	4.0	0%	-
Uranium	mg/L	0.015	0.02	0.0023	0.0030	0%	0%	0.0025	0.0026	0%	0%	0.0016	0.0022	0%	0%	0.0024	0.0025	0%	0%
Vanadium	mg/L	0.006	-	0.0016	0.0019	0%	-	0.0017	0.0017	0%	-	0.0014	0.0019	0%	-	0.0016	0.0017	0%	-
Zinc	mg/L	0.032	-	0.0107	0.013	0%	-	0.0111	0.011	0%	-	0.0116	0.015	0%	-	0.0111	0.011	0%	-

Notes:

Med - Median Annual Concentration

Max - Maximum Annual Concentration

% > Aquatic Health Benchmark and % > Human Health Drinking Water Guideline - percentage of days during the climate year that the concentration is greater than the Aquatic Health Benchmark and Human Health Drinking Water Guideline, respectively.

0.001 - denotes concentrations that are greater than the Aquatic Health Benchmark.

0.001 - denotes concentrations that are greater than the Human Health Drinking Water Guideline.

(a) Aquatic Health Benchmark - The benchmark is equal to the most recent of the PWQO or CWQG (or the BCMOE guideline for parameters without a PWQO or CWQG) or the upper limit of background (95th percentile), whichever is higher (with the exception of cyanide, which has a site-specific guideline). If no guideline exists, then background was used as the benchmark.

(b) Human Health Drinking Water Guideline - The guideline is equal to the ODWS and CDWQG (where the same). For arsenic, the guideline is equal to the CDWQG. For nitrate, the benchmark is equal to the ODWS.

TABLE C4
WATER QUALITY MODELING RESULTS: POST-CLOSURE PHASE STAGE II, AVERAGE CONDITION - MESOMIKENDA LAKE WATERSHED
CÔTÉ GOLD PROJECT

Parameter	Units	Aquatic Health Benchmark ^(a)	Human Health Benchmark ^(b)	MESOMIKENDA LAKE WATERSHED																							
				Bagsverd Lake				Unnamed Lake #1				Bagsverd Creek (Closed Polishing Pond Discharge Point)				Bagsverd Creek (Outflow to Neville Lake)				Neville Lake				Mesomikenda Lake (Upper Basin)			
				Med	Max	% > Aquatic Health Benchmark	% > Human Health Benchmark	Med	Max	% > Aquatic Health Benchmark	% > Human Health Benchmark	Med	Max	% > Aquatic Health Benchmark	% > Human Health Benchmark	Med	Max	% > Aquatic Health Benchmark	% > Human Health Benchmark	Med	Max	% > Aquatic Health Benchmark	% > Human Health Benchmark	Med	Max	% > Aquatic Health Benchmark	% > Human Health Benchmark
Aluminum	mg/L	0.1182	-	0.054	0.057	0%	-	0.055	0.071	0%	-	0.055	0.071	0%	-	0.055	0.071	0%	-	0.061	0.066	0%	-	0.043	0.044	0%	-
Ammonia (Total)	mg/L	6.89	-	0.058	0.061	0%	-	0.059	0.076	0%	-	0.059	0.076	0%	-	0.059	0.076	0%	-	0.065	0.071	0%	-	0.046	0.048	0%	-
Ammonia (Un-ionized)	mg/L	0.019	-	0.00010	0.00038	0%	-	0.00012	0.00045	0%	-	0.00012	0.00045	0%	-	0.00012	0.00045	0%	-	0.00012	0.00044	0%	-	0.00008	0.00032	0%	-
Antimony	mg/L	0.02	0.006	0.00029	0.00031	0%	0%	0.00030	0.00038	0%	0%	0.00030	0.00038	0%	0%	0.00030	0.00038	0%	0%	0.00033	0.000357	0%	0%	0.00024	0.00024	0%	0%
Arsenic	mg/L	0.005	0.01	0.0018	0.0019	0%	0%	0.0018	0.0023	0%	0%	0.0018	0.0023	0%	0%	0.0018	0.0023	0%	0%	0.0020	0.0021	0%	0%	0.0014	0.0015	0%	0%
Barium	mg/L	1.0	1	0.0068	0.0071	0%	0%	0.0069	0.0088	0%	0%	0.0069	0.0088	0%	0%	0.0069	0.0088	0%	0%	0.0076	0.0082	0%	0%	0.0054	0.0056	0%	0%
Boron	mg/L	1.5	5	0.0059	0.0062	0%	0%	0.0060	0.0077	0%	0%	0.0060	0.0077	0%	0%	0.0060	0.0077	0%	0%	0.0066	0.0071	0%	0%	0.0047	0.0048	0%	0%
Cadmium	mg/L	0.000058	0.005	0.000024	0.000025	0%	0%	0.000024	0.000031	0%	0%	0.000024	0.000031	0%	0%	0.000024	0.000031	0%	0%	0.000027	0.000029	0%	0%	0.000019	0.000019	0%	0%
Calcium	mg/L	10.465	-	8.6	9.0	0%	-	8.7	11	7%	-	8.7	11	8%	-	8.7	11	8%	-	9.7	10.4	0%	-	6.9	7.0	0%	-
Chloride	mg/L	120	-	0.84	0.88	0%	-	0.85	1.09	0%	-	0.85	1.09	0%	-	0.85	1.09	0%	-	0.94	1.01	0%	-	0.67	0.69	0%	-
Cobalt	mg/L	0.0025	-	0.00031	0.00033	0%	-	0.00032	0.00041	0%	-	0.00032	0.00041	0%	-	0.00032	0.00041	0%	-	0.00035	0.00038	0%	-	0.00025	0.00026	0%	-
Copper	mg/L	0.005	-	0.0012	0.0013	0%	-	0.0012	0.0016	0%	-	0.0012	0.0016	0%	-	0.0012	0.0016	0%	-	0.0014	0.0015	0%	-	0.0010	0.0010	0%	-
Cyanide (Total)	mg/L	-	-	-	-	-	-	-	-	-	-	-	-	-	-	-	-	-	-	-	-	-	-	-	-	-	-
Cyanide (Free)	mg/L	0.009784	0.2	-	-	-	-	-	-	-	-	-	-	-	-	-	-	-	-	-	-	-	-	-	-	-	-
Iron	mg/L	0.369	-	0.20	0.21	0%	-	0.20	0.26	0%	-	0.20	0.26	0%	-	0.20	0.26	0%	-	0.23	0.24	0%	-	0.16	0.16	0%	-
Lead	mg/L	0.001	0.01	0.000060	0.000064	0%	0%	0.000061	0.000079	0%	0%	0.000061	0.000079	0%	0%	0.000061	0.000079	0%	0%	0.000068	0.000073	0%	0%	0.000048	0.000050	0%	0%
Magnesium	mg/L	2.003	-	1.6	1.7	0%	-	1.6	2.1	5%	-	1.6	2.1	5%	-	1.6	2.1	5%	-	1.8	1.9	0%	-	1.3	1.3	0%	-
Manganese	mg/L	0.7	-	0.068	0.072	0%	-	0.069	0.089	0%	-	0.069	0.089	0%	-	0.069	0.089	0%	-	0.077	0.083	0%	-	0.054	0.056	0%	-
Molybdenum	mg/L	0.073	-	0.0012	0.0012	0%	-	0.0012	0.0015	0%	-	0.0012	0.0015	0%	-	0.0012	0.0015	0%	-	0.0013	0.0014	0%	-	0.0009	0.0010	0%	-
Nickel	mg/L	0.025	-	0.0018	0.0019	0%	-	0.0018	0.0023	0%	-	0.0018	0.0023	0%	-	0.0018	0.0023	0%	-	0.0020	0.0022	0%	-	0.0014	0.0015	0%	-
Nitrate	mg/L	13	10	0.072	0.076	0%	0%	0.073	0.094	0%	0%	0.073	0.094	0%	0%	0.073	0.094	0%	0%	0.081	0.088	0%	0%	0.06	0.06	0%	0%
Phosphorus (Total)	mg/L	0.035	-	0.016	0.017	0%	-	0.016	0.021	0%	-	0.016	0.021	0%	-	0.016	0.021	0%	-	0.018	0.019	0%	-	0.013	0.013	0%	-
Potassium	mg/L	373	-	0.41	0.43	0%	-	0.41	0.53	0%	-	0.41	0.53	0%	-	0.41	0.53	0%	-	0.46	0.49	0%	-	0.32	0.33	0%	-
Sodium	mg/L	1.3365	-	1.2	1.2	0%	-	1.2	1.5	24%	-	1.2	1.5	25%	-	1.2	1.5	23%	-	1.3	1.4	33%	-	0.9	1.0	0%	-
Strontium	mg/L	0.026	-	0.020	0.021	0%	-	0.020	0.026	2%	-	0.020	0.026	1%	-	0.020	0.026	1%	-	0.023	0.024	0%	-	0.016	0.016	0%	-
Sulphate	mg/L	218	-	3.6	3.7	0%	-	3.6	4.6	0%	-	3.6	4.6	0%	-	3.6	4.6	0%	-	4.0	4.3	0%	-	2.8	2.9	0%	-
Uranium	mg/L	0.015	0.02	0.0012	0.0012	0%	0%	0.0012	0.0015	0%	0%	0.0012	0.0015	0%	0%	0.0012	0.0015	0%	0%	0.0013	0.0014	0%	0%	0.0009	0.0010	0%	0%
Vanadium	mg/L	0.006	-	0.0012	0.0012	0%	-	0.0012	0.0015	0%	-	0.0012	0.0015	0%	-	0.0012	0.0015	0%	-	0.0013	0.0014	0%	-	0.0009	0.0010	0%	-
Zinc	mg/L	0.032	-	0.010	0.011	0%	-	0.010	0.013	0%	-	0.010	0.013	0%	-	0.010	0.013	0%	-	0.012	0.012	0%	-	0.008	0.008	0%	-

Notes:
 Med - Median Annual Concentration
 Max - Maximum Annual Concentration
 % > Aquatic Health Benchmark and % > Human Health Drinking Water Guideline - percentage of days during the climate year that the concentration is greater than the Aquatic Health Benchmark and Human Health Drinking Water Guideline, respectively.
 0.001 - denotes concentrations that are greater than the Aquatic Health Benchmark.
 0.001 - denotes concentrations that are greater than the Human Health Drinking Water Guideline.
 (a) Aquatic Health Benchmark - The benchmark is equal to the most recent of the PWQO or CWQG (or the BCMOE guideline for parameters without a PWQO or CWQG) or the upper limit of background (95th percentile), whichever is higher (with the exception of free cyanide, which has a site-specific guideline).
 If no guideline exists, then background was used as the benchmark.
 (b) Human Health Drinking Water Guideline - The guideline is equal to the ODWS and CDWQG (where the same). For arsenic, the guideline is equal to the CDWQG. For nitrate, the benchmark is equal to the ODWS.

**TABLE C5
WATER QUALITY MODELING RESULTS: POST-CLOSURE PHASE STAGE II, 1:25-YEAR DRY CONDITION - MESOMIKENDA LAKE WATERSHED
CÔTÉ GOLD PROJECT**

Parameter	Units	Aquatic Health Benchmark ^(a)	Human Health Benchmark ^(b)	MESOMIKENDA LAKE WATERSHED																							
				Bagsverd Lake				Unnamed Lake #1				Bagsverd Creek (Closed Polishing Pond Discharge Point)				Bagsverd Creek (Outflow to Neville Lake)				Neville Lake				Mesomikenda Lake (Upper Basin)			
				Med	Max	% > Aquatic Health Benchmark	% > Human Health Benchmark	Med	Max	% > Aquatic Health Benchmark	% > Human Health Benchmark	Med	Max	% > Aquatic Health Benchmark	% > Human Health Benchmark	Med	Max	% > Aquatic Health Benchmark	% > Human Health Benchmark	Med	Max	% > Aquatic Health Benchmark	% > Human Health Benchmark	Med	Max	% > Aquatic Health Benchmark	% > Human Health Benchmark
Aluminum	mg/L	0.1182	-	0.055	0.061	0%	-	0.057	0.103	0%	-	0.057	0.103	0%	-	0.055	0.101	0%	-	0.060	0.072	0%	-	0.044	0.044	0%	-
Ammonia (Total)	mg/L	6.89	-	0.059	0.066	0%	-	0.061	0.111	0%	-	0.061	0.111	0%	-	0.059	0.108	0%	-	0.065	0.077	0%	-	0.047	0.048	0%	-
Ammonia (Un-ionized)	mg/L	0.019	-	0.00011	0.00041	0%	-	0.00015	0.00062	0%	-	0.00014	0.00062	0%	-	0.00007	0.00062	0%	-	0.00013	0.00049	0%	-	0.00008	0.00032	0%	-
Antimony	mg/L	0.02	0.006	0.00030	0.000334	0%	0%	0.00031	0.00056	0%	0%	0.00031	0.00056	0%	0%	0.00030	0.00055	0%	0%	0.00033	0.000391	0%	0%	0.00024	0.00024	0%	0%
Arsenic	mg/L	0.005	0.01	0.0018	0.0020	0%	0%	0.0018	0.0034	0%	0%	0.0019	0.0034	0%	0%	0.0018	0.0033	0%	0%	0.0020	0.0023	0%	0%	0.0014	0.0015	0%	0%
Barium	mg/L	1.0	1	0.0069	0.0077	0%	0%	0.0071	0.0129	0%	0%	0.0071	0.013	0%	0%	0.0069	0.0126	0%	0%	0.0075	0.0090	0%	0%	0.0055	0.0056	0%	0%
Boron	mg/L	1.5	5	0.0060	0.0067	0%	0%	0.0062	0.0112	0%	0%	0.0062	0.0112	0%	0%	0.0060	0.0110	0%	0%	0.0066	0.0078	0%	0%	0.0048	0.0048	0%	0%
Cadmium	mg/L	0.000058	0.005	0.000024	0.000027	0%	0%	0.000025	0.000045	0%	0%	0.000025	0.000045	0%	0%	0.000024	0.000044	0%	0%	0.000026	0.000031	0%	0%	0.000019	0.000019	0%	0%
Calcium	mg/L	10.465	-	8.7	9.7	0%	-	9.0	16	35%	-	9.0	16	35%	-	8.7	16	19%	-	9.5	11.4	28%	-	6.9	7.0	0%	-
Chloride	mg/L	120	-	0.85	0.95	0%	-	0.87	1.59	0%	-	0.87	1.59	0%	-	0.85	1.56	0%	-	0.93	1.11	0%	-	0.68	0.69	0%	-
Cobalt	mg/L	0.0025	-	0.00032	0.00036	0%	-	0.00033	0.00060	0%	-	0.00033	0.00060	0%	-	0.00032	0.00058	0%	-	0.00035	0.00042	0%	-	0.00025	0.00026	0%	-
Copper	mg/L	0.005	-	0.0012	0.0014	0%	-	0.0013	0.0023	0%	-	0.0013	0.0023	0%	-	0.0012	0.0023	0%	-	0.0014	0.0016	0%	-	0.0010	0.0010	0%	-
Cyanide (Total)	mg/L	-	-	-	-	-	-	-	-	-	-	-	-	-	-	-	-	-	-	-	-	-	-	-	-	-	-
Cyanide (Free)	mg/L	0.009784	0.2	-	-	-	-	-	-	-	-	-	-	-	-	-	-	-	-	-	-	-	-	-	-	-	-
Iron	mg/L	0.369	-	0.20	0.23	0%	-	0.21	0.38	2%	-	0.21	0.38	2%	-	0.20	0.37	1%	-	0.22	0.27	0%	-	0.16	0.16	0%	-
Lead	mg/L	0.001	0.01	0.000061	0.000068	0%	0%	0.000063	0.000115	0%	0%	0.000063	0.000115	0%	0%	0.000061	0.000113	0%	0%	0.000067	0.000080	0%	0%	0.000049	0.000050	0%	0%
Magnesium	mg/L	2.003	-	1.6	1.8	0%	-	1.6	3.0	30%	-	1.6	3.0	30%	-	1.6	2.9	16%	-	1.8	2.1	16%	-	1.3	1.3	0%	-
Manganese	mg/L	0.7	-	0.069	0.077	0%	-	0.071	0.13	0%	-	0.071	0.13	0%	-	0.069	0.13	0%	-	0.076	0.090	0%	-	0.055	0.056	0%	-
Molybdenum	mg/L	0.073	-	0.0012	0.0013	0%	-	0.0012	0.0022	0%	-	0.0012	0.0022	0%	-	0.0012	0.0022	0%	-	0.0013	0.0016	0%	-	0.0010	0.0010	0%	-
Nickel	mg/L	0.025	-	0.0018	0.0020	0%	-	0.0019	0.0034	0%	-	0.0019	0.0034	0%	-	0.0018	0.0033	0%	-	0.0020	0.0024	0%	-	0.0014	0.0015	0%	-
Nitrate	mg/L	13	10	0.073	0.082	0%	0%	0.076	0.138	0%	0%	0.076	0.138	0%	0%	0.073	0.135	0%	0%	0.080	0.096	0%	0%	0.06	0.06	0%	0%
Phosphorus (Total)	mg/L	0.035	-	0.016	0.018	0%	-	0.016	0.030	0%	-	0.016	0.030	0%	-	0.016	0.029	0%	-	0.018	0.021	0%	-	0.013	0.013	0%	-
Potassium	mg/L	373	-	0.41	0.46	0%	-	0.42	0.77	0%	-	0.43	0.77	0%	-	0.41	0.76	0%	-	0.45	0.54	0%	-	0.33	0.33	0%	-
Sodium	mg/L	1.3365	-	1.2	1.3	0%	-	1.2	2.2	38%	-	1.2	2.2	38%	-	1.2	2.2	22%	-	1.3	1.6	41%	-	1.0	1.0	0%	-
Strontium	mg/L	0.026	-	0.020	0.023	0%	-	0.021	0.038	28%	-	0.021	0.038	28%	-	0.020	0.037	14%	-	0.022	0.027	11%	-	0.016	0.016	0%	-
Sulphate	mg/L	218	-	3.6	4.0	0%	-	3.7	6.8	0%	-	3.7	6.8	0%	-	3.6	6.6	0%	-	3.9	4.7	0%	-	2.9	2.9	0%	-
Uranium	mg/L	0.015	0.02	0.0012	0.0013	0%	0%	0.0012	0.0022	0%	0%	0.0012	0.0022	0%	0%	0.0012	0.0022	0%	0%	0.0013	0.0016	0%	0%	0.0010	0.0010	0%	0%
Vanadium	mg/L	0.006	-	0.0012	0.0013	0%	-	0.0012	0.0022	0%	-	0.0012	0.0022	0%	-	0.0012	0.0022	0%	-	0.0013	0.0016	0%	-	0.0010	0.0010	0%	-
Zinc	mg/L	0.032	-	0.010	0.012	0%	-	0.011	0.020	0%	-	0.011	0.020	0%	-	0.010	0.019	0%	-	0.011	0.014	0%	-	0.008	0.008	0%	-

Notes:
 Med - Median Annual Concentration
 Max - Maximum Annual Concentration
 % > Aquatic Health Benchmark and % > Human Health Drinking Water Guideline - percentage of days during the climate year that the concentration is greater than the Aquatic Health Benchmark and Human Health Drinking Water Guideline, respectively.

0.001 - denotes concentrations that are greater than the Aquatic Health Benchmark.
 0.001 - denotes concentrations that are greater than the Human Health Drinking Water Guideline.

(a) Aquatic Health Benchmark - The benchmark is equal to the most recent of the PWQO or CWQG (or the BCMOE guideline for parameters without a PWQO or CWQG) or the upper limit of background (95th percentile), whichever is higher (with the exception of free cyanide, which has a site-specific guideline). If no guideline exists, then background was used as the benchmark.

(b) Human Health Drinking Water Guideline - The guideline is equal to the ODWS and CDWQG (where the same). For arsenic, the guideline is equal to the CDWQG. For nitrate, the benchmark is equal to the ODWS.

TABLE C6
WATER QUALITY MODELING RESULTS: POST-CLOSURE PHASE STAGE II, 1:25-YEAR WET CONDITION - MESOMIKENDA LAKE WATERSHED
CÔTÉ GOLD PROJECT

Parameter	Units	Aquatic Health Benchmark ^(a)	Human Health Benchmark ^(b)	MESOMIKENDA LAKE WATERSHED																							
				Bagsverd Lake				Unnamed Lake #1				Bagsverd Creek (Closed Polishing Pond Discharge Point)				Bagsverd Creek (Outflow to Neville Lake)				Neville Lake				Mesomikenda Lake (Upper Basin)			
				Med	Max	% > Aquatic Health Benchmark	% > Human Health Benchmark	Med	Max	% > Aquatic Health Benchmark	% > Human Health Benchmark	Med	Max	% > Aquatic Health Benchmark	% > Human Health Benchmark	Med	Max	% > Aquatic Health Benchmark	% > Human Health Benchmark	Med	Max	% > Aquatic Health Benchmark	% > Human Health Benchmark	Med	Max	% > Aquatic Health Benchmark	% > Human Health Benchmark
Aluminum	mg/L	0.1182	-	0.054	0.056	0%	-	0.053	0.072	0%	-	0.054	0.072	0%	-	0.053	0.072	0%	-	0.059	0.065	0%	-	0.045	0.046	0%	-
Ammonia (Total)	mg/L	6.89	-	0.058	0.060	0%	-	0.057	0.078	0%	-	0.058	0.078	0%	-	0.057	0.078	0%	-	0.064	0.070	0%	-	0.048	0.050	0%	-
Ammonia (Un-ionized)	mg/L	0.019	-	0.00010	0.00038	0%	-	0.00012	0.00046	0%	-	0.00012	0.00046	0%	-	0.00012	0.00046	0%	-	0.00012	0.00044	0%	-	0.00008	0.00033	0%	-
Antimony	mg/L	0.02	0.006	0.00029	0.00031	0%	0%	0.00029	0.00039	0%	0%	0.00030	0.00039	0%	0%	0.00029	0.00039	0%	0%	0.00032	0.00036	0%	0%	0.00024	0.00025	0%	0%
Arsenic	mg/L	0.005	0.01	0.0018	0.0018	0%	0%	0.0017	0.0024	0%	0%	0.0018	0.0024	0%	0%	0.0017	0.0024	0%	0%	0.0019	0.0021	0%	0%	0.0015	0.0015	0%	0%
Barium	mg/L	1.0	1	0.0067	0.0070	0%	0%	0.0067	0.0090	0%	0%	0.0068	0.0090	0%	0%	0.0067	0.0091	0%	0%	0.0074	0.0082	0%	0%	0.0056	0.0058	0%	0%
Boron	mg/L	1.5	5	0.0059	0.0061	0%	0%	0.0058	0.0079	0%	0%	0.0059	0.0079	0%	0%	0.0058	0.0079	0%	0%	0.0065	0.0071	0%	0%	0.0049	0.0050	0%	0%
Cadmium	mg/L	0.000058	0.005	0.000023	0.000024	0%	0%	0.000023	0.000031	0%	0%	0.000024	0.000031	0%	0%	0.000023	0.000032	0%	0%	0.000026	0.000028	0%	0%	0.000019	0.000020	0%	0%
Calcium	mg/L	10.465	-	8.5	8.9	0%	-	8.5	11	6%	-	8.6	11	6%	-	8.4	11	7%	-	9.4	10.4	0%	-	7.1	7.3	0%	-
Chloride	mg/L	120	-	0.83	0.87	0%	-	0.82	1.12	0%	-	0.84	1.12	0%	-	0.82	1.12	0%	-	0.92	1.01	0%	-	0.69	0.71	0%	-
Cobalt	mg/L	0.0025	-	0.00031	0.00033	0%	-	0.00031	0.00042	0%	-	0.00031	0.00042	0%	-	0.00031	0.00042	0%	-	0.00034	0.00038	0%	-	0.00026	0.00027	0%	-
Copper	mg/L	0.005	-	0.0012	0.0013	0%	-	0.0012	0.0016	0%	-	0.0012	0.0016	0%	-	0.0012	0.0016	0%	-	0.0013	0.0015	0%	-	0.0010	0.0010	0%	-
Cyanide (Total)	mg/L	-	-	-	-	-	-	-	-	-	-	-	-	-	-	-	-	-	-	-	-	-	-	-	-	-	-
Cyanide (Free)	mg/L	0.009784	0.2	-	-	-	-	-	-	-	-	-	-	-	-	-	-	-	-	-	-	-	-	-	-	-	-
Iron	mg/L	0.369	-	0.20	0.21	0%	-	0.20	0.27	0%	-	0.20	0.27	0%	-	0.20	0.27	0%	-	0.22	0.24	0%	-	0.17	0.17	0%	-
Lead	mg/L	0.001	0.01	0.000060	0.000063	0%	0%	0.000060	0.000081	0%	0%	0.000061	0.000081	0%	0%	0.000059	0.000081	0%	0%	0.000066	0.000073	0%	0%	0.000050	0.000051	0%	0%
Magnesium	mg/L	2.003	-	1.6	1.6	0%	-	1.6	2.1	4%	-	1.6	2.1	4%	-	1.5	2.1	4%	-	1.7	1.9	0%	-	1.3	1.3	0%	-
Manganese	mg/L	0.7	-	0.068	0.071	0%	-	0.067	0.09	0%	-	0.068	0.09	0%	-	0.067	0.09	0%	-	0.075	0.082	0%	-	0.056	0.058	0%	-
Molybdenum	mg/L	0.073	-	0.0012	0.0012	0%	-	0.0012	0.0016	0%	-	0.0012	0.0016	0%	-	0.0012	0.0016	0%	-	0.0013	0.0014	0%	-	0.0010	0.0010	0%	-
Nickel	mg/L	0.025	-	0.0018	0.0018	0%	-	0.0018	0.0024	0%	-	0.0018	0.0024	0%	-	0.0017	0.0024	0%	-	0.0019	0.0021	0%	-	0.0015	0.0015	0%	-
Nitrate	mg/L	13	10	0.072	0.075	0%	0%	0.071	0.096	0%	0%	0.072	0.096	0%	0%	0.071	0.097	0%	0%	0.079	0.087	0%	0%	0.06	0.06	0%	0%
Phosphorus (Total)	mg/L	0.035	-	0.016	0.016	0%	-	0.016	0.021	0%	-	0.016	0.021	0%	-	0.015	0.021	0%	-	0.017	0.019	0%	-	0.013	0.013	0%	-
Potassium	mg/L	373	-	0.40	0.42	0%	-	0.40	0.54	0%	-	0.41	0.54	0%	-	0.40	0.54	0%	-	0.45	0.49	0%	-	0.34	0.35	0%	-
Sodium	mg/L	1.3365	-	1.2	1.2	0%	-	1.2	1.6	17%	-	1.2	1.6	18%	-	1.2	1.6	17%	-	1.3	1.4	42%	-	1.0	1.0	0%	-
Strontium	mg/L	0.026	-	0.020	0.021	0%	-	0.020	0.027	3%	-	0.020	0.027	3%	-	0.020	0.027	3%	-	0.022	0.024	0%	-	0.017	0.017	0%	-
Sulphate	mg/L	218	-	3.5	3.7	0%	-	3.5	4.7	0%	-	3.6	4.7	0%	-	3.5	4.7	0%	-	3.9	4.3	0%	-	2.9	3.0	0%	-
Uranium	mg/L	0.015	0.02	0.0012	0.0012	0%	0%	0.0012	0.0016	0%	0%	0.0012	0.0016	0%	0%	0.0012	0.0016	0%	0%	0.0013	0.0014	0%	0%	0.0010	0.0010	0%	0%
Vanadium	mg/L	0.006	-	0.0012	0.0012	0%	-	0.0012	0.0016	0%	-	0.0012	0.0016	0%	-	0.0012	0.0016	0%	-	0.0013	0.0014	0%	-	0.0010	0.0010	0%	-
Zinc	mg/L	0.032	-	0.010	0.011	0%	-	0.010	0.014	0%	-	0.010	0.014	0%	-	0.010	0.014	0%	-	0.011	0.012	0%	-	0.008	0.009	0%	-

Notes:
 Med - Median Annual Concentration
 Max - Maximum Annual Concentration
 % > Aquatic Health Benchmark and % > Human Health Drinking Water Guideline - percentage of days during the climate year that the concentration is greater than the Aquatic Health Benchmark and Human Health Drinking Water Guideline, respectively.

0.001 - denotes concentrations that are greater than the Aquatic Health Benchmark.
 0.001 - denotes concentrations that are greater than the Human Health Drinking Water Guideline.

(a) Aquatic Health Benchmark - The benchmark is equal to the most recent of the PWQO or CWQG (or the BCMOE guideline for parameters without a PWQO or CWQG) or the upper limit of background (95th percentile), whichever is higher (with the exception of free cyanide, which has a site-specific guideline). If no guideline exists, then background was used as the benchmark.

(b) Human Health Drinking Water Guideline - The guideline is equal to the ODWS and CDWQG (where the same). For arsenic, the guideline is equal to the CDWQG. For nitrate, the benchmark is equal to the ODWS.

As a global, employee-owned organisation with over 50 years of experience, Golder Associates is driven by our purpose to engineer earth's development while preserving earth's integrity. We deliver solutions that help our clients achieve their sustainable development goals by providing a wide range of independent consulting, design and construction services in our specialist areas of earth, environment and energy.

For more information, visit golder.com

Africa	+ 27 11 254 4800
Asia	+ 86 21 6258 5522
Australasia	+ 61 3 8862 3500
Europe	+ 356 21 42 30 20
North America	+ 1 800 275 3281
South America	+ 56 2 2616 2000

solutions@golder.com
www.golder.com

Golder Associates Ltd.
1010 Lorne Street
Sudbury, Ontario, P3C 4R9
Canada
T: +1 (705) 524 6861



